

# Serial Flash for code storage – SPI bus

Cross reference guide



# How to use this cross reference guide

This cross reference guide is intended to help you choose the ST product most compatible with competitive devices.

It is very easy to use: simply identify the competitor's part number, with the memory you are looking for, and you'll find the ST equivalent product. In all cases, we recommend that you check the parameters in the appropriate datasheet, to ensure that the product meets the requirements of your application.

Please note that this guide is based on information published by other manufacturers and is accurate at the time of going to press.

Serial Flash complete cross reference information is available at [www.st.com/serialflash](http://www.st.com/serialflash) or on the ST intranet.

If you are interested in receiving more information about these and other products or if you have any technical enquiry, please contact the ST sales office in your area, or send an e-mail to [apps.serialflash@st.com](mailto:apps.serialflash@st.com) (for application support) or [ask.memory@st.com](mailto:ask.memory@st.com) (for general enquiries)

## ST Serial Flash part numbering scheme

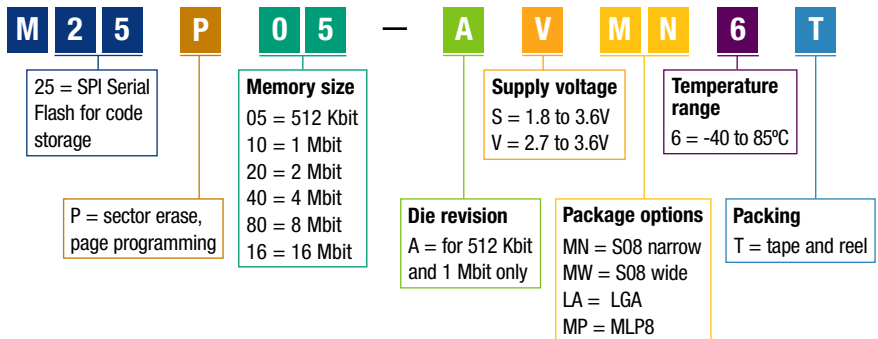

Size	ATMEL part number	ST part number	Variations between ATMEL and ST
512Kb	AT25F512N-10SI-2.7	M25P05-AVMN6T	Footprint compatible, download compatible at 20MHz, software to be adapted for update and read ID
1Mb	AT25F1024N-10SI-2.7	M25P10-AVMN6T	
	AT25F1024AN-10SI-2.7	M25P10-AVMN6T	
2Mb	AT25F2048N-10SI-2.7	M25P20-VMN6T	Footprint compatible, download compatible at 20MHz, software to be adapted for update and read ID, green package

## ATMEL Serial Flash part numbering scheme

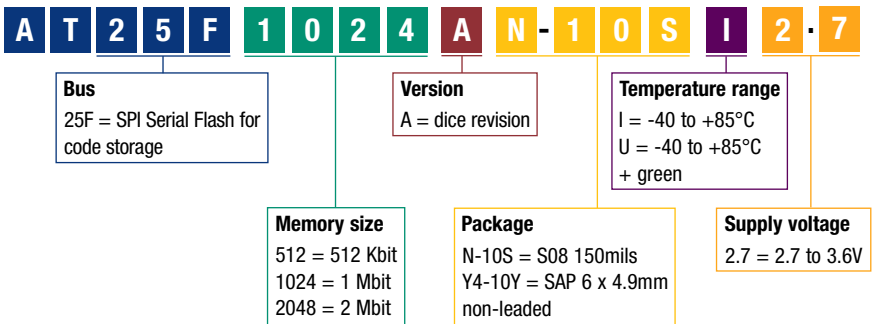

Size	ICE part number	ST part number	Variations between ICE and ST
512Kb	ICE25P05	M25P05-AVMN6T	Footprint compatible, download and update compatible at 20MHz, software to be adapted for read ID
1Mb	ICE25P10	M25P10-AVMN6T	

## ICE Serial Flash part numbering scheme

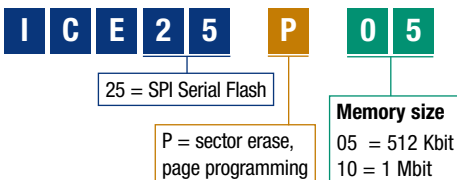

Size	Macronix part number	ST part number	Variations between Macronix and ST
8Mb	MX25L802MC-50	N.A.	Specific product in S028 for Japanese market
16Mb	MX25L1602MC-50	N.A.	

N.A. = EEPROM format, but using FLASH memory cell

## Macronix Serial Flash part numbering scheme

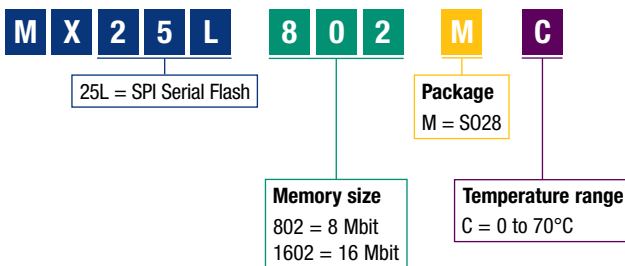

## PMC to ST

Size	PMC part number	ST part number	Variations between PMC and ST
512Kb	PM25LV512-25SC	M25P05-AVMN6T	Footprint compatible, download and update compatible at 25MHz, compatible read ID
1Mb	PM25LV010-25SC	M25P10-AVMN6T	Footprint compatible, download compatible at 20MHz, software to be adapted for update, different read ID

## PMC Serial Flash part numbering scheme

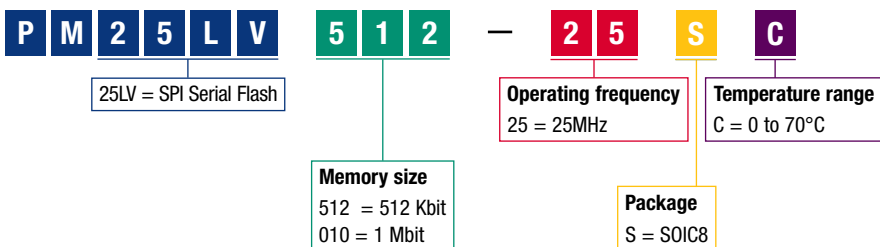

Size	Saifun part number	ST part number	Variations between Saifun and ST
512Kb	SA25C512LN	*	Uses EEPROM format, see also M45PExx series
	SA25C512LMN, X	M25P05-AVMN6T	
	SA25C512LEN	*	
	SA25C512LEMN, X	M25P05-AVMN6T	
	SA25C512HN	*	
	SA25C512HMN, X	*	
	SA25C512HEN	*	
	SA25C512HEMN, X	*	
1Mb	SA25C1024LN	*	
	SA25C1024LMN, X	M25P10-AVMN6T	
	SA25C1024LEN	*	
	SA25C1024LEMN, X	M25P10-AVMN6T	
	SA25C1024HN	*	
	SA25C1024HMN, X	*	
	SA25C1024HEN	*	
	SA25C1024HEMN, X	*	

\* Contact marketing for availability

## Saifun Serial Flash part numbering scheme

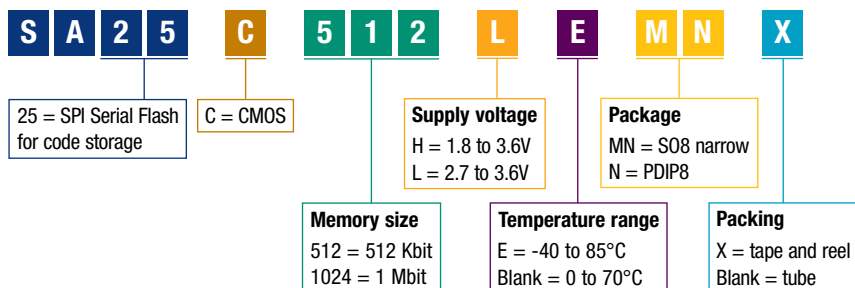

Size	SST part number	ST part number	Variations between SST and ST
512Kb	SST25VF512-20-4C-SA	M25P05-AVMN6T	Footprint compatible, download compatible at 20MHz, software to be adapted for update, read ID could be compatible, also announced in -40 to +85°C
	SST25VF512-20-4C-QA	M25P05-AVMP6T	
1Mb	SST25VF010-20-4C-SA	M25P10-AVMN6T	
	SST25VF010-20-4C-QA	M25P10-AVMP6T	
2Mb	SST25VF020-20-4C-SA	M25P20-VMN6T	Footprint compatible, different sector size, download compatible at 20MHz, software to be adapted for update, read ID could be compatible, also announced in -40 to +85°C
	SST25VF020-20-4C-QA	M25P20-VMP6T	
4Mb	SST25VF040-20-4C-QA	M25P40-VMP6T	
	SST25VF080-33-4C-SA	M25P80-VMN6T	
8Mb	SST25VF080-33-4C-SA	M25P80-VMN6T	
	SST25VF080-33-4C-QA	M25P80-VMP6T	
16Mb	SST25VF016-33-4C-QA	M25P16-VMP6T	

## SST Serial Flash part numbering scheme

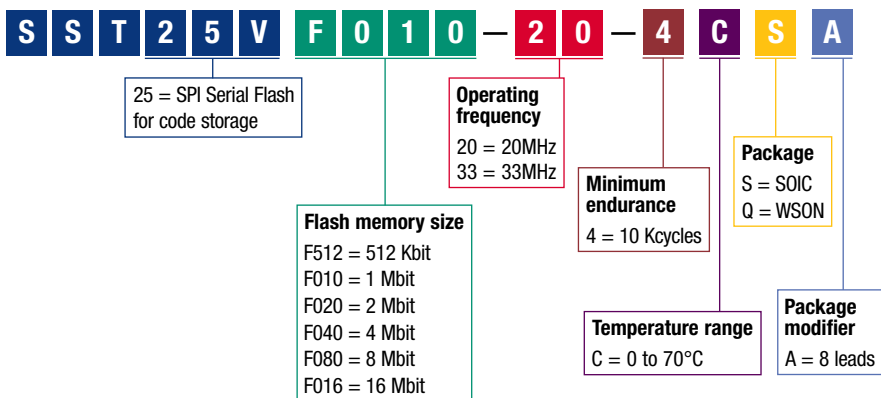

Size	WINBOND part number	ST part number	Variations between WINBOND and ST
1Mb	W45B012Z	M25P10-AVMN6T	Footprint compatible, software to be adapted for download and update, different read ID

## WINBOND Serial Flash part numbering scheme

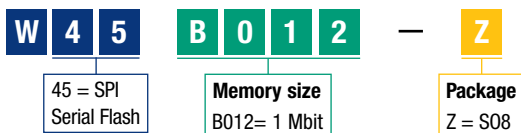

## YMC to ST

Size	YMC part number	ST part number	Variations between YMC and ST
512Kb	Y25F05	M25P05-AVMN6T	Footprint compatible, download compatible at 20MHz, software to be adapted for update, compatible read ID

## YMC Serial Flash part numbering scheme

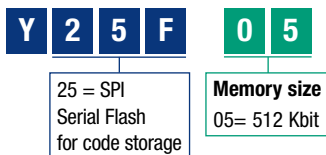



Information furnished is believed to be accurate and reliable. However, STMicroelectronics assumes no responsibility for the consequences of use of such information nor for any infringement of patents or other rights of third parties which may result from its use. No license is granted by implication or otherwise under any patent or patent rights of STMicroelectronics. Specifications mentioned in this publication are subject to change without notice. This publication supersedes and replaces all information previously supplied. STMicroelectronics products are not authorized for use as critical components in life support devices or systems without express written approval of STMicroelectronics.

© STMicroelectronics - September 2003 - Printed in Italy - All rights reserved

The STMicroelectronics corporate logo is a registered trademark of the STMicroelectronics group of companies. All other names are the property of their respective owners.

**For selected STMicroelectronics sales offices fax:**

France +33 1 55489569; Germany +49 89 4605454; Italy +39 02 8250449; Japan +81 3 57838216; Singapore +65 6481 5124;  
Sweden +46 8 58774411; Switzerland +41 22 9292900; United Kingdom and Eire +44 1628 890391; USA +1 781 861 2678

**Full product information at [www.st.com](http://www.st.com)**

ORDER CODE: CDSERRASH0703



Recycle with this symbol