

## TO-251-3L Plastic-Encapsulate MOSFETS

### CJD01N60 N-Channel Power MOSFET

#### General Description

The high voltage MOSFET uses an advanced termination scheme to provide enhanced voltage-blocking capability without degrading performance over time. In addition, this advanced MOSFET is designed to withstand high energy in avalanche and commutation modes. The new energy efficient design also offers a drain-to-source diode with a fast recovery time. Designed for high voltage, high speed switching applications in power suppliers, converters and PWM motor controls, these devices are particularly well suited for bridge circuits where diode speed and commutating safe operating areas are critical and offer additional and safety margin against unexpected voltage transients.

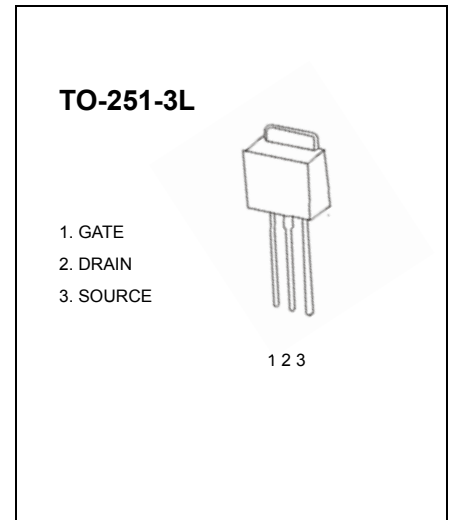

#### FEATURES

- Robust High Voltage Termination
- Avalanche Energy Specified
- Source-to-Drain Diode Recovery Time Comparable to a Discrete Fast Recovery Diode
- Diode is Characterized for Use in Bridge Circuits
- $I_{DSS}$  and  $V_{DS(on)}$  Specified at Elevated Temperature

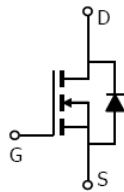

#### Maximum ratings ( $T_a=25^{\circ}\text{C}$ unless otherwise noted)

Parameter	Symbol	Value	Unit
Drain-Source Voltage	$V_{DS}$	600	V
Gate-Source Voltage	$V_{GS}$	$\pm 20$	
Single Pulse Avalanche Energy (note 1)	$E_{AS}$	20	mJ
Continuous Drain Current	$I_D$	1	A
Power Dissipation	$P_D$	1	W
Thermal Resistance from Junction to Ambient	$R_{\theta JA}$	125	$^{\circ}\text{C}/\text{W}$
Junction Temperature	$T_J$	150	$^{\circ}\text{C}$
Storage Temperature	$T_{STG}$	-50 ~+150	

### Electrical characteristics ( $T_a=25^\circ\text{C}$ unless otherwise noted)

Parameter	Symbol	Test Condition	Min	Typ	Max	Units
Drain-source breakdown voltage	$V_{(BR)DSS}$	$V_{GS} = 0V, I_D = 250\mu A$	600			V
Gate-threshold voltage (note 2)	$V_{GS(th)}$	$V_{DS} = V_{GS}, I_D = 250\mu A$	2.0		4.0	
Gate-body leakage current (note 2)	$I_{GSS}$	$V_{DS} = 0V, V_{GS} = \pm 20V$			$\pm 100$	nA
Zero gate voltage drain current	$I_{DSS}$	$V_{DS} = 600V, V_{GS} = 0V$			100	$\mu A$
Drain-source on-state resistance (note 2)	$R_{DS(on)}$	$V_{GS} = 10V, I_D = 0.6A$			10	$\Omega$
Forward transconductance (note 2)	$g_{fs}$	$V_{DS} = 50V, I_D = 0.5A$	0.5			S
Input capacitance (note 3)	$C_{iss}$	$V_{DS} = 25V, V_{GS} = 0V,$ $f = 1MHz$		210		pF
Output capacitance (note 3)	$C_{oss}$			28		
Reverse transfer capacitance (note 3)	$C_{rss}$			4.2		
Turn-on delay time (note 3)	$t_{d(on)}$	$V_{DD} = 300V, I_D = 1A,$ $V_{GS} = 10V, R_G = 18\Omega$		8		nS
Rise time (note 3)	$t_r$			21		
Turn-off delay time (note 3)	$t_{d(off)}$			18		
Fall time (note 3)	$t_f$			24		
Forward on voltage (note 2)	$V_{SD}$	$V_{GS} = 0V, I_S = 1A$			1.5	V

**Notes:**

1.  $V_{DD} = 100V$ , starting  $T_J = 25^\circ\text{C}$ ,  $L = 10mH, R_G = 25\Omega$ ,  $I_{AS} = 2A, V_{GS} = 10V$ .
2. Pulse test: Pulse width  $\leq 300\mu s$ , duty cycle  $\leq 2\%$ .
3. These parameters have no way to verify.

# Typical Characteristics

# CJD01N60

Output Characteristics

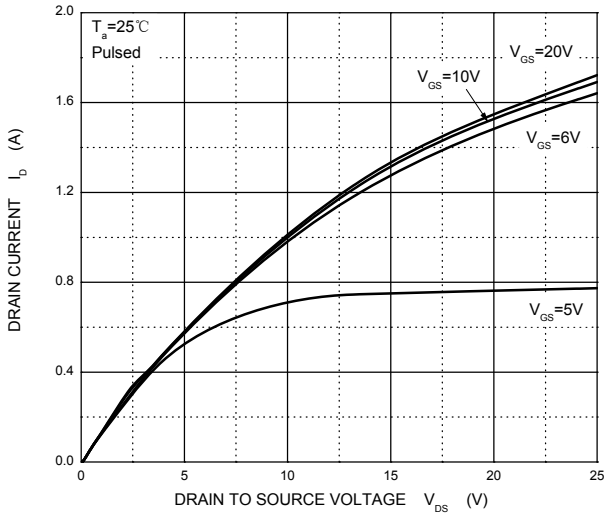

Transfer Characteristics

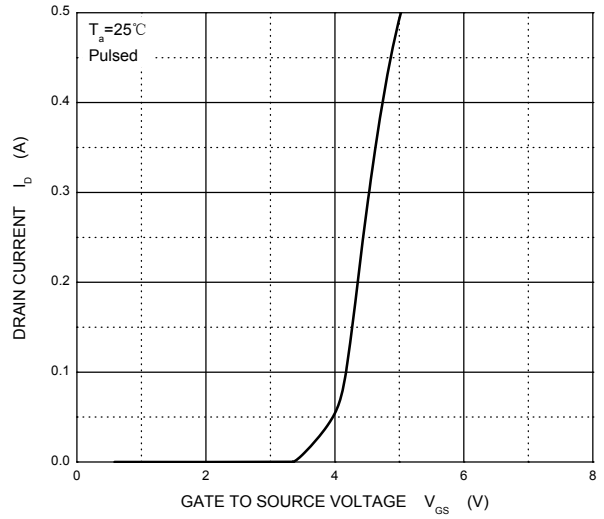

$R_{DS(ON)}$  —  $I_D$

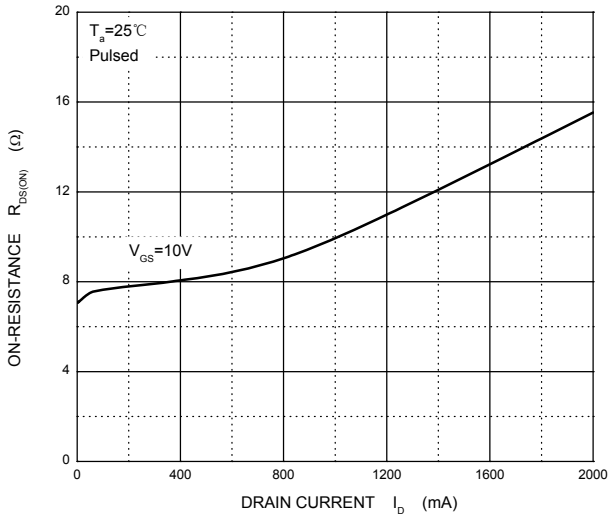

$R_{DS(ON)}$  —  $V_{GS}$

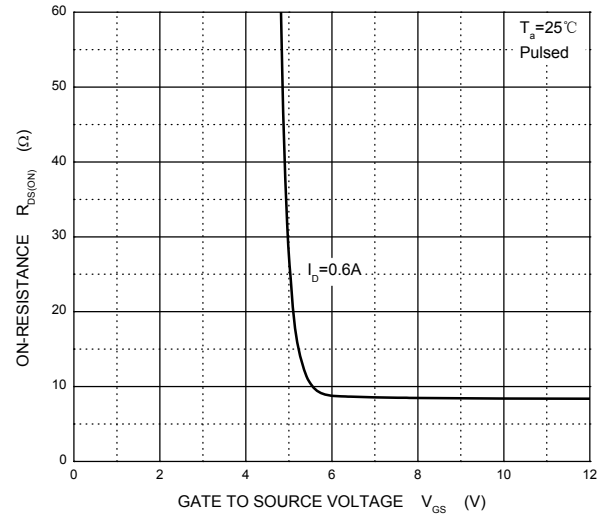

$I_S$  —  $V_{SD}$

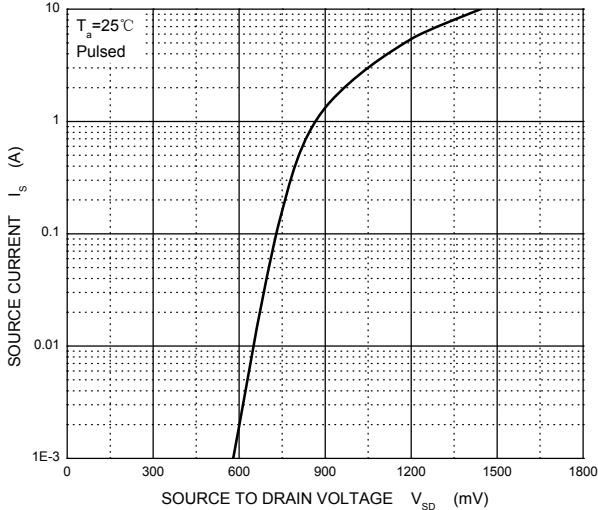

# TO-251-3L Package Outline Dimensions

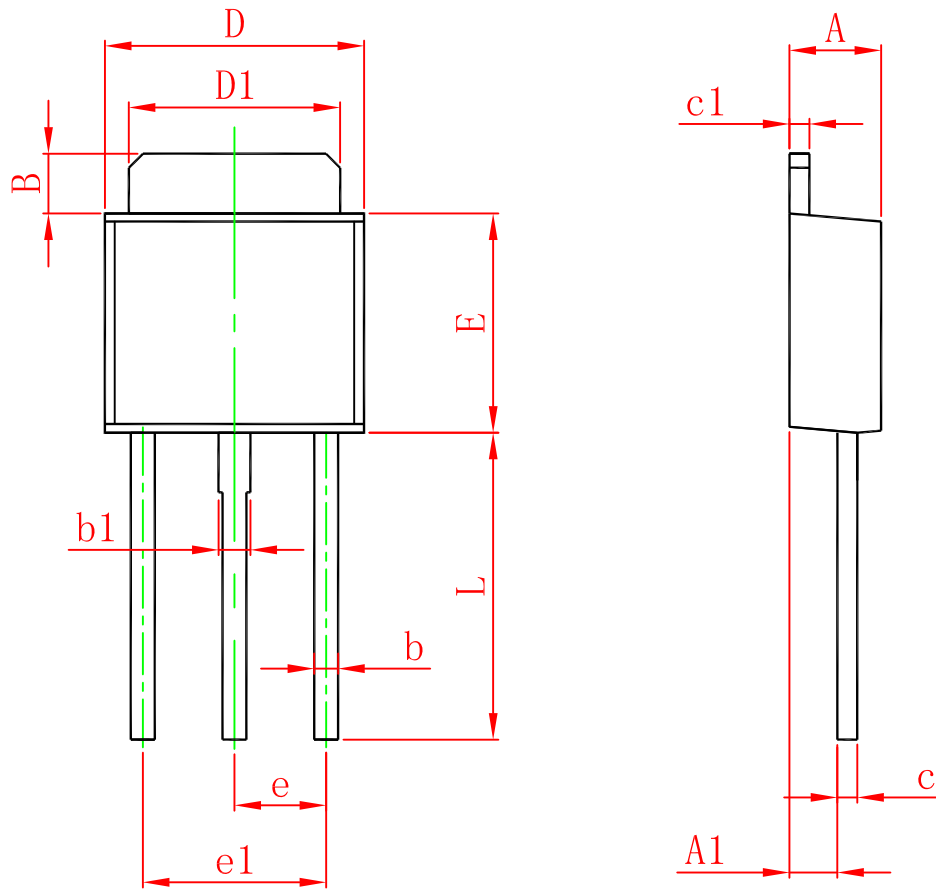

Symbol	Dimensions In Millimeters		Dimensions In Inches	
	Min.	Max.	Min.	Max.
A	2.200	2.400	0.087	0.094
A1	1.050	1.350	0.042	0.054
B	1.350	1.650	0.053	0.065
b	0.500	0.700	0.020	0.028
b1	0.700	0.900	0.028	0.035
c	0.430	0.580	0.017	0.023
c1	0.430	0.580	0.017	0.023
D	6.350	6.650	0.250	0.262
D1	5.200	5.400	0.205	0.213
E	5.400	5.700	0.213	0.224
e	2.300 TYP.		0.091 TYP.	
e1	4.500	4.700	0.177	0.185
L	7.500	7.900	0.295	0.311