



## General Description:

Using CRM's proprietary trench design, advanced FS(field stop) technology and integrated with Free Wheeling Diode, the 1200V Trench FS IGBT offers superior conduction and switching performances, high avalanche ruggedness.

## Features:

- Trench FS Technology, Positive temperature coefficient
- Low saturation voltage:  $V_{CE(sat)}$ , typ =1.95V  
@  $I_C = 25A$
- Extremely enhanced avalanche capability

## Applications:

Power switch circuit of induction cooker(IH).

## Ordering Information

Part Number	Package	Marking	Delivery mode
CRG25T120BKR3S	TO-247	G25T120BKR3S	Tube

## Absolute Maximum Ratings

( $T_J = 25^\circ C$  unless otherwise specified):

Symbol	Parameter	Rating	Units
$V_{CES}$	Collector-Emitter Voltage	1200	V
$V_{GES}$	Gate- Emitter Voltage	$\pm 20$	V
$I_C$	Collector Current@ $T_C = 25^\circ C$	50	A
	Collector Current @ $T_C = 100^\circ C$	25	A
$I_{CM}^{a1}$	Pulsed Collector Current@ $T_C = 25^\circ C$	75	A
$I_F$	Diode Continuous Forward Current @ $T_C = 100^\circ C$	25	A
$I_{FM}$	Diode Maximum Forward Current@ $T_C = 25^\circ C$	75	A
$P_D$	Power Dissipation @ $T_C = 25^\circ C$	208	W
	Power Dissipation @ $T_C = 100^\circ C$	83	W
$T_J, T_{stg}$	Operating Junction and Storage Temperature Range	150, -55 to +150	$^\circ C$
$T_L$	Maximum Temperature for Soldering	300	$^\circ C$

a1: Repetitive rating; pulse width limited by maximum junction temperature

$V_{CES}$	1200	V
$I_C$	25	A
$P_{tot}(T_C=25^\circ C)$	208	W
$V_{CE(SAT)}$	1.95	V

TO-247

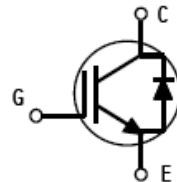

**Thermal Characteristics**

Symbol	Parameter	Typ.	Max.	Units
$R_{\theta JC}$	Thermal Resistance, Junction to case for IGBT	--	0.6	$^{\circ}\text{C}/\text{W}$
$R_{\theta JA}$	Thermal Resistance, Junction to Ambient	--	40	$^{\circ}\text{C}/\text{W}$

**Electrical Characteristics of the IGBT ( $T_j = 25^{\circ}\text{C}$  unless otherwise specified):**

OFF Characteristics						
Symbol	Parameter	Test Conditions	Rating			Units
			Min.	Typ.	Max.	
$V_{CES}$	Collector-Emitter Breakdown Voltage	$V_{GE}=0\text{V}, I_{CE}=1\text{mA}$	1200	--	--	V
$I_{CES}$	Collector-Emitter Leakage Current	$V_{GE}=0\text{V}, V_{CE}=V_{CES}$	--	--	1.0	mA
$I_{GES(F)}$	Gate to Emitter Forward Leakage	$V_{GE}=+20\text{V}$	--	--	+250	nA
$I_{GES(R)}$	Gate to Source Reverse Leakage	$V_{GE}=-20\text{V}$	--	--	-250	nA

ON Characteristics						
Symbol	Parameter	Test Conditions	Rating			Units
			Min.	Typ.	Max.	
$V_{CE(sat)}$	Collector-Emitter Saturation Voltage	$I_C=25\text{A}, V_{GE}=15\text{V}$	--	1.95	2.5	V
$V_{FM}$	Diode Forward Voltage	$I_F=25\text{A}$	--	2.7	3.2	V
$V_{GE(TH)}$	Gate Threshold Voltage	$I_C=250\mu\text{A}, V_{CE}=V_{GE}$	4.5	5.8	7.5	V

Pulse width  $t_p \leq 300 \mu\text{s}, \delta \leq 2\%$

Dynamic Characteristics						
Symbol	Parameter	Test Conditions	Rating			Units
			Min.	Typ.	Max.	
$C_{ies}$	Input Capacitance	$V_{CE}=30\text{V}, V_{GE}=0\text{V}$ $f=1\text{MHz}$	--	2370	--	pF
$C_{oes}$	Output Capacitance		--	59	--	
$C_{res}$	Reverse Transfer Capacitance		--	43	--	

Resistive Switching Characteristics						
Symbol	Parameter	Test Conditions	Rating			Units
			Min.	Typ.	Max.	
$t_{d(ON)}$	Turn-on Delay Time	$T_j = 25^{\circ}\text{C}$ $V_{CE}=600\text{V}, I_C=25\text{A}$ $V_{GE}=0/15\text{V},$ $R_g=10\Omega$ Inductive Load	--	34	--	ns
$t_r$	Rise Time		--	36	--	
$t_{d(OFF)}$	Turn-Off Delay Time		--	198	--	
$t_f$	Fall Time		--	75	--	
$E_{on}$	Turn-On Switching Loss		--	1.88	--	mJ
$E_{off}$	Turn-Off Switching Loss		--	0.95	--	
$E_{ts}$	Total Switching Loss	--	2.83	--		



# CRG25T120BKR3S



$Q_g$	Total Gate Charge	$V_{CE}=960V, I_C=25A$ $V_{GE}=15V$	--	142	--	nC
$Q_{ge}$	Gate to Emitter Charge		--	23	--	
$Q_{gc}$	Gate to Collector Charge		--	75	--	

### Characteristics Cure

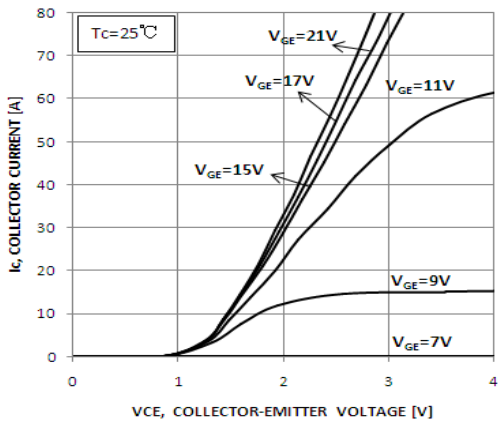

Figure 1. Typical Output Characteristics

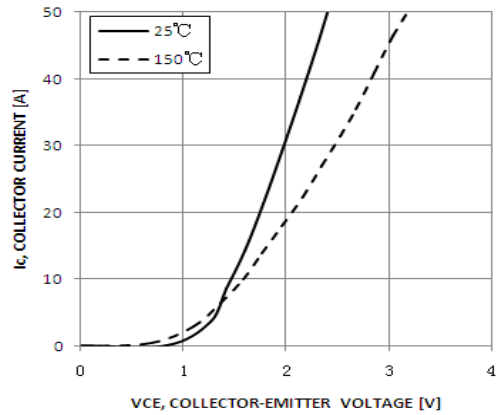

Figure 2. Typical Output Characteristics

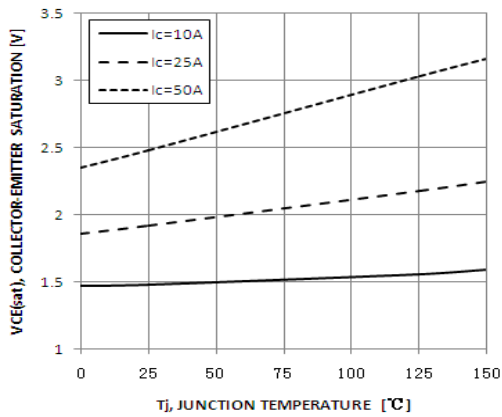

Figure 3. Typical Saturation Voltage vs. Junction Temperature

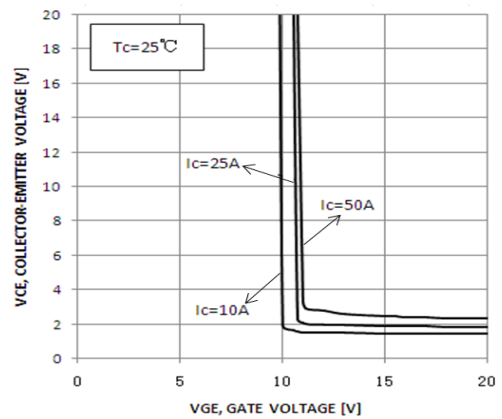

Figure 4. Typical Saturation Voltage vs. Gate-Emmitter Voltage

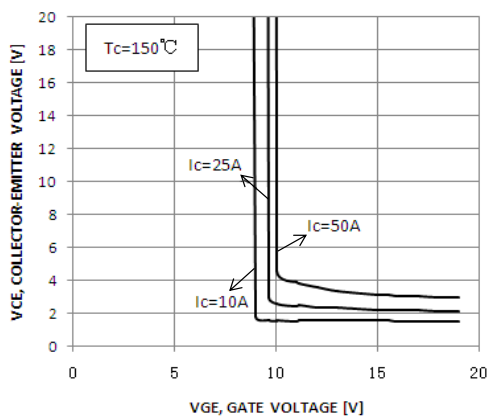

Figure 5. Typical Saturation Voltage vs. Gate-Emmitter Voltage

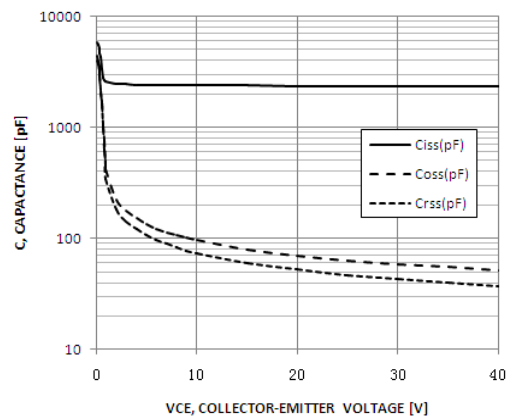

Figure 6. Typical Capacitance Characteristics

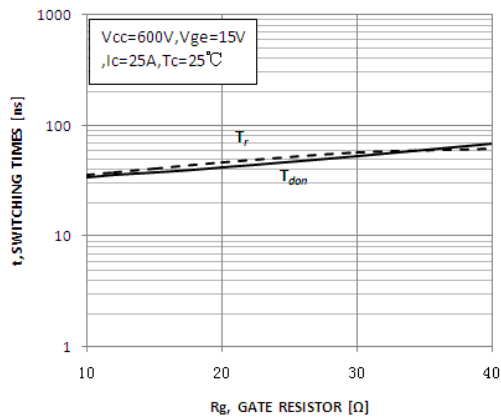

Figure 7. Typical Turn-On Characteristics vs. Gate Resistance

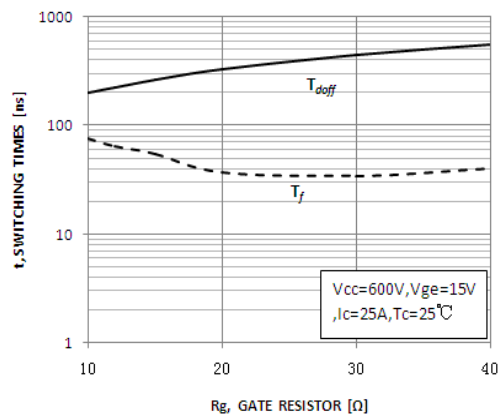

Figure 8. Typical Turn-Off Characteristics vs. Gate Resistance

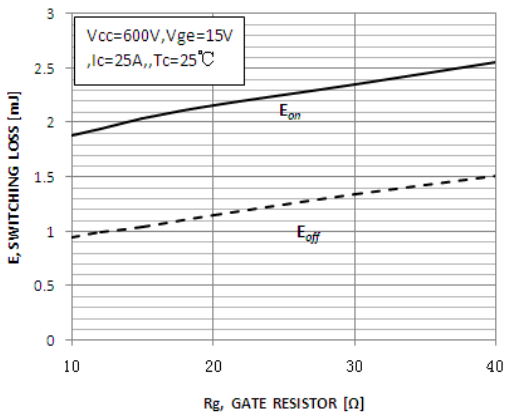

Figure 9. Typical Switching Losses vs. Gate Resistance

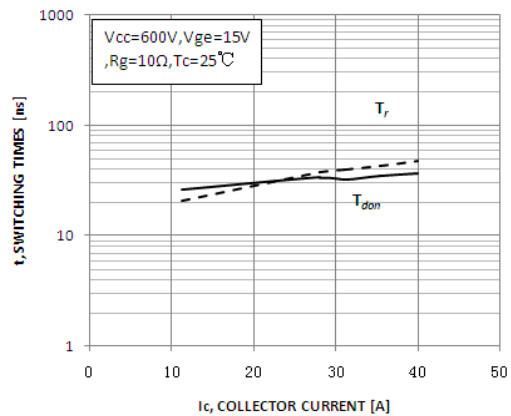

Figure 10. Typical Turn-On Characteristics vs. Collector Current

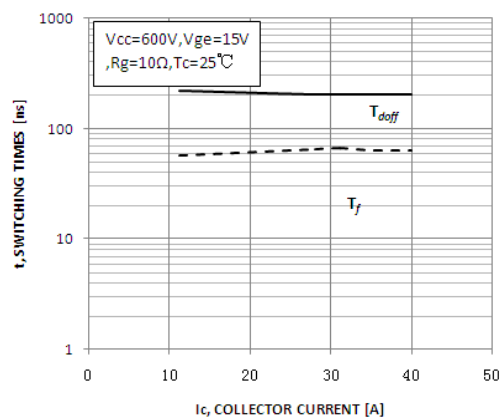

Figure 11. Typical Turn-Off Characteristics vs. Collector Current

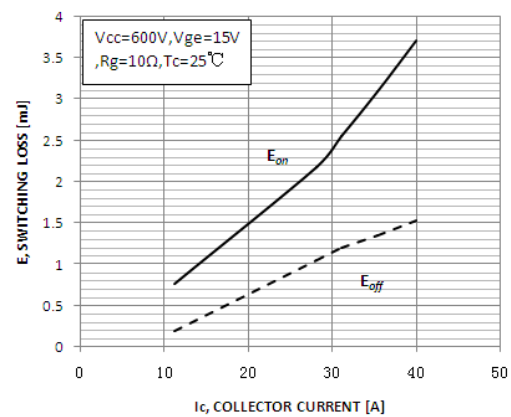

Figure 12. Typical Switching Losses vs. Collector Current

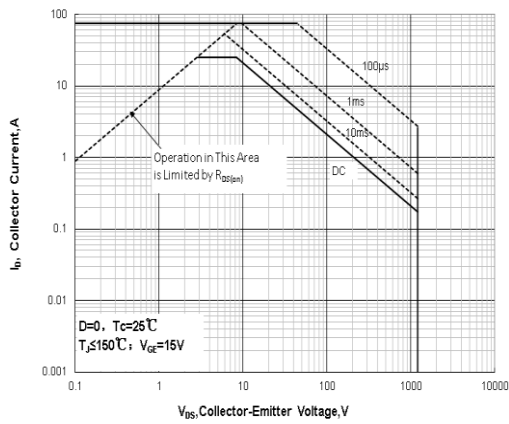

Figure 13. Typical IGBT Forward Safe Operating Area

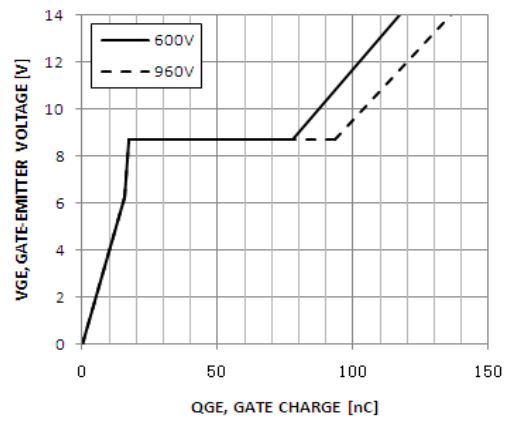

Figure 14. Typical Gate Charge

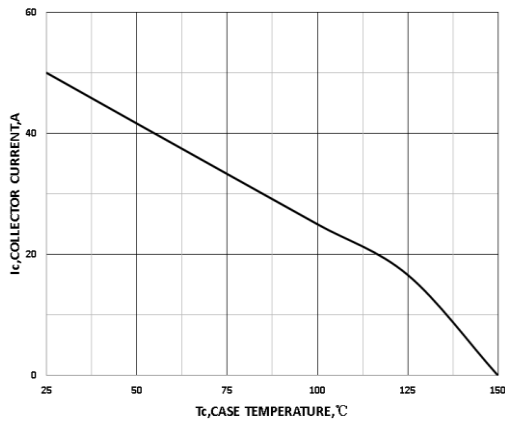

Figure 15. Collector Current vs. Case Temperature

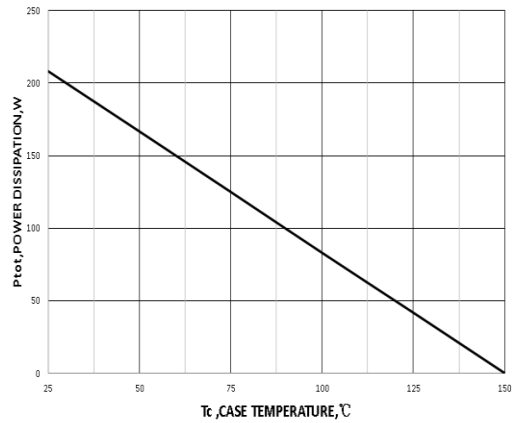

Figure 16. Power Dissipation vs. Case Temperature

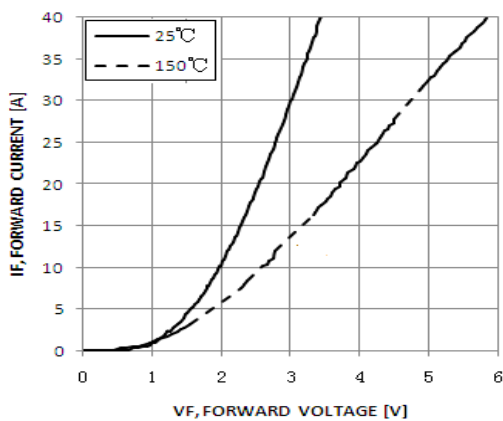

Figure 17. Typical Diode Forward Characteristics

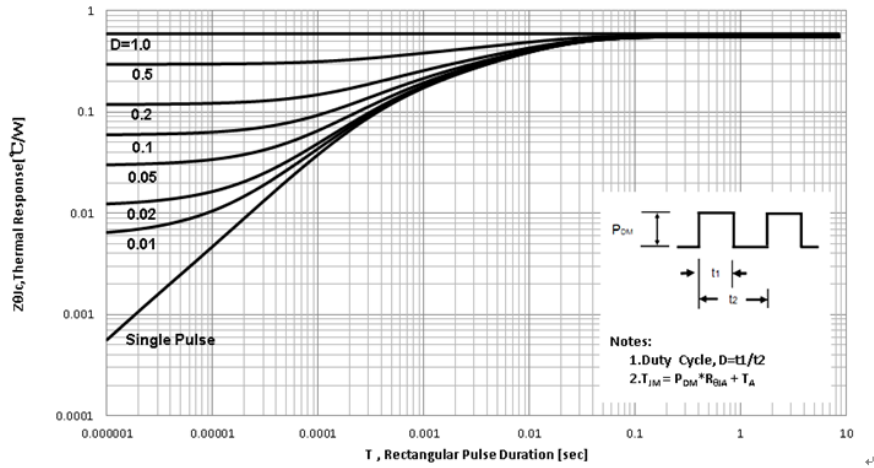
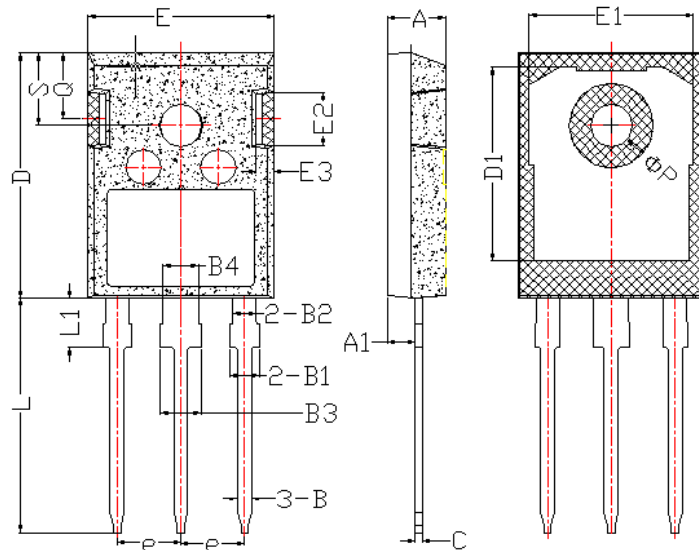

Figure 18. IGBT Transient Thermal Impedance

**Package Information**

Items	Values(mm)	
	MIN	MAX
A	4.6	5.2
A1	2,2	2.6
B	0.9	1.4
B1	1.75	2.35
B2	1.75	2.15
B3	2.8	3.35
B4	2.8	3.15
C	0.5	0.7
D	20.60	21.30
D1	16	18
E	15.5	16.10
E1	13	14.7
E2	3.80	5.3
E3	0.8	2.60
e	5.2	5.7
L	19	20.5
L1	3.9	4.6
ΦP	3.3	3.70
Q	5.2	6.00
S	5.8	6.6

**TO-247 Package**





**The name and content of poisonous and harmful material in products**

Part's Name	Hazardous Substance									
	Pb	Hg	Cd	Cr(VI)	PBB	PBDE	DIBP	DEHP	DBP	BBP
Limit	≤ 0.1%	≤ 0.1%	≤ 0.01%	≤0.1%	≤0.1%	≤0.1%	≤0.1%	≤0.1%	≤0.1%	≤0.1%
Lead Frame	○	○	○	○	○	○	○	○	○	○
Molding	○	○	○	○	○	○	○	○	○	○
Chip	○	○	○	○	○	○	○	○	○	○
Wire Bonding	○	○	○	○	○	○	○	○	○	○
Solder	×	○	○	○	○	○	○	○	○	○
Note	○: Means the hazardous material is under the criterion of 2011/65/EU. ×: Means the hazardous material exceeds the criterion of 2011/65/EU. The plumbum element of solder exist in products presently, but within the allowed range of Eurogroup's RoHS.									

**Warnings**

1. Exceeding the maximum ratings of the device in performance may cause damage to the device, even the permanent failure, which may affect the dependability of the machine. It is suggested to be used under 80 percent of the maximum ratings of the device.
2. When installing the heat sink, please pay attention to the torsional moment and the smoothness of the heat sink.
3. IGBTs is the device which is sensitive to the static electricity, it is necessary to protect the device from being damaged by the static electricity when using it.
4. This publication is made by Huajing Microelectronics and subject to regular change without notice.

**WUXI CHINA RESOURCES HUAJING MICROELECTRONICS CO., LTD.**

**Add:** No.14 Liangxi RD. Wuxi, Jiangsu, China      **Mail:** 214061      <https://www.crmicro.com>  
**Tel:** 0510-85807228      **Fax:** 0510-85800864

**Marketing Part:**      **Post:** 214061    **Tel / Fax:** 0510-85807228-3663/5508  
 0510-85800360 (Fax)

**Application and Service:** **Post:** 214061    **Tel / Fax:** 0510-85807228-3399 / 2227