

### FEATURES

- Low Cost**
- Three Video Amplifiers in One Package**
- Optimized for Driving Cables in Video Systems**
- Excellent Video Specifications ( $R_L = 150 \Omega$ )**
  - Gain Flatness 0.1 dB to 50 MHz
  - 0.03% Differential Gain Error
  - 0.06° Differential Phase Error
- Low Power**
- Operates on Single +3 V to  $\pm 15$  V Power Supplies**
- 5.5 mA/Amplifier Max Power Supply Current**
- High Speed**
  - 125 MHz Unity Gain Bandwidth ( $-3$  dB)
  - 500 V/ $\mu$ s Slew Rate
- High Speed Disable Function per Channel**
- Turn-Off Time 80 ns**
- Easy to Use**
  - 50 mA Output Current
  - Output Swing to 1 V of Rails

### APPLICATIONS

- Video Line Driver
- LCD Drivers
- Computer Video Plug-In Boards
- Ultrasound
- RGB Amplifier
- CCD Based Systems

### PRODUCT DESCRIPTION

The AD813 is a low power, single supply triple video amplifier. Each of the three current feedback amplifiers has 50 mA of output current, and is optimized for driving one back-terminated video load ( $150 \Omega$ ). The AD813 features gain flatness of 0.1 dB to

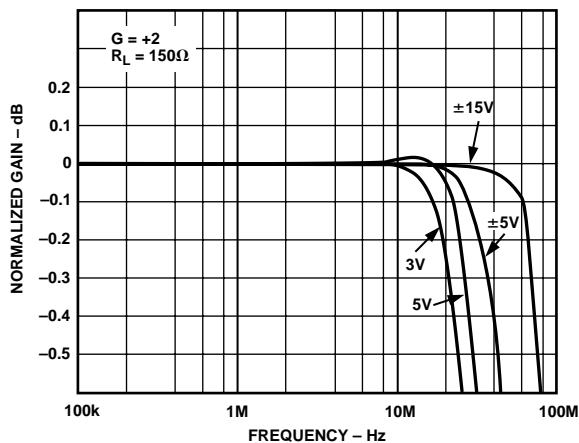

Figure 1. Fine Scale Gain Flatness vs. Frequency,  $G = +2$ ,  $R_L = 150 \Omega$

### REV. B

Information furnished by Analog Devices is believed to be accurate and reliable. However, no responsibility is assumed by Analog Devices for its use, nor for any infringements of patents or other rights of third parties which may result from its use. No license is granted by implication or otherwise under any patent or patent rights of Analog Devices.

### PIN CONFIGURATION

14-Lead DIP and SOIC

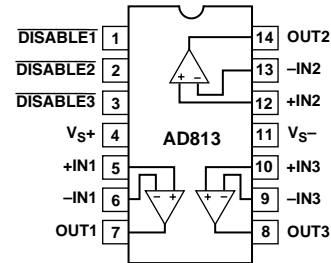

50 MHz while offering differential gain and phase error of 0.03% and 0.06°. This makes the AD813 ideal for broadcast and consumer video electronics.

The AD813 offers low power of 5.5 mA per amplifier max and runs on a single +3 V power supply. The outputs of each amplifier swing to within one volt of either supply rail to easily accommodate video signals. While operating on a single +5 V supply the AD813 still achieves 0.1 dB flatness to 20 MHz and 0.05% & 0.05° of differential gain and phase performance. All this is offered in a small 14-lead plastic DIP or SOIC package. These features make this triple amplifier ideal for portable and battery powered applications where size and power are critical.

The outstanding bandwidth of 125 MHz along with 500 V/ $\mu$ s of slew rate make the AD813 useful in many general purpose, high speed applications where a single +3 V or dual power supplies up to  $\pm 15$  V are needed. Furthermore the AD813 contains a high speed disable function for each amplifier in order to power down the amplifier or high impedance the output. This can then be used in video multiplexing applications. The AD813 is available in the industrial temperature range of  $-40^\circ\text{C}$  to  $+85^\circ\text{C}$  in plastic DIP and SOIC packages as well as chips.

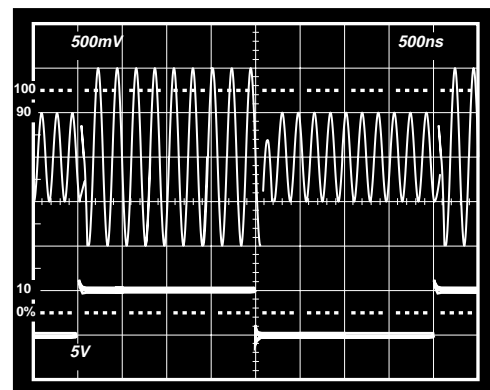

Figure 2. Channel Switching Characteristics for a 3:1 Mux

# AD813—SPECIFICATIONS

Dual Supply (@  $T_A = +25^\circ\text{C}$ ,  $R_L = 150\ \Omega$ , unless otherwise noted)

Model	Conditions	$V_s$	AD813A			Units
			Min	Typ	Max	
<b>DYNAMIC PERFORMANCE</b>						
-3 dB Bandwidth	G = +2, No Peaking	$\pm 5\ \text{V}$	45	65		MHz
		$\pm 15\ \text{V}$	75	100		MHz
Bandwidth for 0.1 dB Flatness	G = +2	$\pm 5\ \text{V}$	15	25		MHz
		$\pm 15\ \text{V}$	25	50		MHz
Slew Rate <sup>1</sup>	G = +2, $R_L = 1\ \text{k}\Omega$	$\pm 5\ \text{V}$		150		V/ $\mu\text{s}$
		$\pm 15\ \text{V}$	150	250		V/ $\mu\text{s}$
	G = -1, $R_L = 1\ \text{k}\Omega$	$\pm 5\ \text{V}$		225		V/ $\mu\text{s}$
		$\pm 15\ \text{V}$		450		V/ $\mu\text{s}$
Settling Time to 0.1%	G = -1, $R_L = 1\ \text{k}\Omega$ $V_O = 3\ \text{V Step}$ $V_O = 10\ \text{V Step}$	$\pm 5\ \text{V}$		50		ns
		$\pm 15\ \text{V}$		40		ns
<b>NOISE/HARMONIC PERFORMANCE</b>						
Total Harmonic Distortion	$f_C = 1\ \text{MHz}$ , $R_L = 1\ \text{k}\Omega$	$\pm 15\ \text{V}$		-90		dBc
Input Voltage Noise	$f = 10\ \text{kHz}$	$\pm 5\ \text{V}$ , $\pm 15\ \text{V}$		3.5		$\text{nV}/\sqrt{\text{Hz}}$
Input Current Noise	$f = 10\ \text{kHz}$ , +In	$\pm 5\ \text{V}$ , $\pm 15\ \text{V}$		1.5		$\text{pA}/\sqrt{\text{Hz}}$
		$\pm 5\ \text{V}$ , $\pm 15\ \text{V}$		18		$\text{pA}/\sqrt{\text{Hz}}$
Differential Gain Error	NTSC, G = $\pm 2$ , $R_L = 150\ \Omega$	$\pm 5\ \text{V}$		0.08		%
		$\pm 15\ \text{V}$		0.03	0.09	%
Differential Phase Error		$\pm 5\ \text{V}$		0.13		Degrees
		$\pm 15\ \text{V}$		0.06	0.12	Degrees
<b>DC PERFORMANCE</b>						
Input Offset Voltage	$T_{\text{MIN}}-T_{\text{MAX}}$	$\pm 5\ \text{V}$ , $\pm 15\ \text{V}$		2	5	mV
					12	mV
Offset Drift	$T_{\text{MIN}}-T_{\text{MAX}}$	$\pm 5\ \text{V}$ , $\pm 15\ \text{V}$		15		$\mu\text{V}/^\circ\text{C}$
		$\pm 5\ \text{V}$ , $\pm 15\ \text{V}$		5	30	$\mu\text{A}$
-Input Bias Current	$T_{\text{MIN}}-T_{\text{MAX}}$	$\pm 5\ \text{V}$ , $\pm 15\ \text{V}$			35	$\mu\text{A}$
		$\pm 5\ \text{V}$ , $\pm 15\ \text{V}$		0.5	1.7	$\mu\text{A}$
+Input Bias Current	$T_{\text{MIN}}-T_{\text{MAX}}$	$\pm 5\ \text{V}$ , $\pm 15\ \text{V}$			2.5	$\mu\text{A}$
		$\pm 5\ \text{V}$ , $\pm 15\ \text{V}$		0.5	1.7	$\mu\text{A}$
Open-Loop Voltage Gain	$T_{\text{MIN}}-T_{\text{MAX}}$ $V_O = \pm 2.5\ \text{V}$ , $R_L = 150\ \Omega$	$\pm 5\ \text{V}$	69	76		dB
		$\pm 15\ \text{V}$	66			dB
		$\pm 15\ \text{V}$	73	82		dB
Open-Loop Transresistance	$T_{\text{MIN}}-T_{\text{MAX}}$ $V_O = \pm 10\ \text{V}$ , $R_L = 1\ \text{k}\Omega$	$\pm 5\ \text{V}$	72			dB
		$\pm 5\ \text{V}$	300	500		$\text{k}\Omega$
		$\pm 15\ \text{V}$	200			$\text{k}\Omega$
		$\pm 15\ \text{V}$	400	900		$\text{k}\Omega$
$T_{\text{MIN}}-T_{\text{MAX}}$ $V_O = \pm 10\ \text{V}$ , $R_L = 1\ \text{k}\Omega$	$T_{\text{MIN}}-T_{\text{MAX}}$ $V_O = \pm 10\ \text{V}$ , $R_L = 1\ \text{k}\Omega$	$\pm 5\ \text{V}$	300			$\text{k}\Omega$
		$\pm 15\ \text{V}$	400	900		$\text{k}\Omega$
		$\pm 15\ \text{V}$	300			$\text{k}\Omega$
		$\pm 15\ \text{V}$	300			$\text{k}\Omega$
<b>INPUT CHARACTERISTICS</b>						
Input Resistance	+Input	$\pm 15\ \text{V}$		15		$\text{M}\Omega$
		$\pm 15\ \text{V}$		65		$\Omega$
Input Capacitance	+Input	$\pm 15\ \text{V}$		1.7		pF
		$\pm 15\ \text{V}$		$\pm 4.0$		V
Input Common Mode Voltage Range		$\pm 15\ \text{V}$		$\pm 13.5$		V
		$\pm 15\ \text{V}$		$\pm 13.5$		V
Common-Mode Rejection Ratio	$V_{\text{CM}} = \pm 2.5\ \text{V}$	$\pm 5\ \text{V}$	54	58		dB
		$\pm 5\ \text{V}$		2	3	$\mu\text{A}/\text{V}$
-Input Current	$V_{\text{CM}} = \pm 10\ \text{V}$	$\pm 15\ \text{V}$		0.07	0.15	$\mu\text{A}/\text{V}$
		$\pm 15\ \text{V}$		0.07	0.15	$\mu\text{A}/\text{V}$
+Input Current	$V_{\text{CM}} = \pm 10\ \text{V}$	$\pm 15\ \text{V}$	57	62		dB
		$\pm 15\ \text{V}$		1.5	3.0	$\mu\text{A}/\text{V}$
-Input Current	$V_{\text{CM}} = \pm 10\ \text{V}$	$\pm 15\ \text{V}$		0.05	0.1	$\mu\text{A}/\text{V}$
		$\pm 15\ \text{V}$		0.05	0.1	$\mu\text{A}/\text{V}$

Model	Conditions	V <sub>s</sub>	AD813A			Units
			Min	Typ	Max	
<b>OUTPUT CHARACTERISTICS</b>						
Output Voltage Swing	R <sub>L</sub> = 150 Ω, T <sub>MIN</sub> -T <sub>MAX</sub> R <sub>L</sub> = 1 kΩ, T <sub>MIN</sub> -T <sub>MAX</sub>	±5 V	3.5	3.8		±V
Output Current		±15 V	13.6	14.0		±V
Short Circuit Current	G = +2, R <sub>F</sub> = 715 Ω V <sub>IN</sub> = 2 V	±5 V	25	40		mA
		±15 V	30	50		mA
		±15 V		100		mA
<b>MATCHING CHARACTERISTICS</b>						
<b>Dynamic</b>						
Crosstalk	G = +2, f = 5 MHz	±5 V, ±15 V		-65		dB
Gain Flatness Match	G = +2, f = 40 MHz	±15 V		0.1		dB
<b>DC</b>						
Input Offset Voltage	T <sub>MIN</sub> -T <sub>MAX</sub>	±5 V, ±15 V		0.5	3.5	mV
-Input Bias Current	T <sub>MIN</sub> -T <sub>MAX</sub>	±5 V, ±15 V		2	25	μA
<b>POWER SUPPLY</b>						
Operating Range	Per Amplifier	±5 V	±1.2		±18	V
Quiescent Current		±15 V		3.5	4.0	mA
	T <sub>MIN</sub> -T <sub>MAX</sub> Per Amplifier	±15 V		4.5	5.5	mA
Quiescent Current, Powered Down		±5 V		0.5	0.65	mA
		±15 V		0.75	1.0	mA
Power Supply Rejection Ratio	V <sub>s</sub> = ±1.5 V to ±15 V		72	80		dB
Input Offset Voltage				0.3	0.8	μA/V
-Input Current				0.005	0.05	μA/V
+Input Current						
<b>DISABLE CHARACTERISTICS</b>						
Off Isolation	f = 5 MHz	±5 V, ±15 V		-57		dB
Off Output Impedance	G = +1	±5 V, ±15 V		12.5		pF
Channel-to-Channel Isolation	2 or 3 Channels	±5 V, ±15 V		-65		dB
Mux, f = 5 MHz						
Turn-On Time		±5 V, ±15 V		100		ns
Turn-Off Time				80		ns

## NOTES

<sup>1</sup>Slew rate measurement is based on 10% to 90% rise time in the specified closed-loop gain.

Specifications subject to change without notice.

# AD813—SPECIFICATIONS

Single Supply (@  $T_A = +25^\circ\text{C}$ ,  $R_L = 150\ \Omega$ , unless otherwise noted)

Model	Conditions	$V_S$	AD813A			Units
			Min	Typ	Max	
<b>DYNAMIC PERFORMANCE</b>						
-3 dB Bandwidth	G = +2, No Peaking	+5 V	35	50		MHz
		+3 V	25	40		MHz
Bandwidth for 0.1 dB Flatness	G = +2	+5 V	12	20		MHz
		+3 V	8	15		MHz
Slew Rate <sup>1</sup>	G = +2, $R_L = 1\ \text{k}\Omega$	+5 V		100		V/ $\mu\text{s}$
		+3 V		50		V/ $\mu\text{s}$
<b>NOISE/HARMONIC PERFORMANCE</b>						
Input Voltage Noise	f = 10 kHz	+5 V, +3 V		3.5		$\text{nV}/\sqrt{\text{Hz}}$
Input Current Noise	f = 10 kHz, +In -In	+5 V, +3 V		1.5		$\text{pA}/\sqrt{\text{Hz}}$
		+5 V, +3 V		18		$\text{pA}/\sqrt{\text{Hz}}$
Differential Gain Error <sup>2</sup>	NTSC, G = +2, $R_L = 150\ \Omega$	+5 V		0.05		%
Differential Phase Error <sup>2</sup>	G = +1 G = +2 G = +1	+3 V		0.2		%
		+5 V +3 V		0.05 0.2		Degrees Degrees
<b>DC PERFORMANCE</b>						
Input Offset Voltage	$T_{\text{MIN}}-T_{\text{MAX}}$	+5 V, +3 V		1.5	5	mV
						10
Offset Drift		+5 V, +3 V		7		$\mu\text{V}/^\circ\text{C}$
-Input Bias Current	$T_{\text{MIN}}-T_{\text{MAX}}$	+5 V, +3 V		7	30	$\mu\text{A}$
+Input Bias Current					40	$\mu\text{A}$
Open-Loop Voltage Gain	$T_{\text{MIN}}-T_{\text{MAX}}$ $V_O = +2.5\ \text{V p-p}$ $V_O = +0.7\ \text{V p-p}$	+5 V +3 V		65	70	dB
						69
Open-Loop Transresistance	$V_O = +3\ \text{V p-p}$ $V_O = +1\ \text{V p-p}$	+5 V +3 V		180	300	$\text{k}\Omega$
						225
<b>INPUT CHARACTERISTICS</b>						
Input Resistance	+Input -Input	+5 V, +3 V +5 V		15		$\text{M}\Omega$
					90	
Input Capacitance	+Input			2		pF
Input Common Mode Voltage Range		+5 V	1.0		4.0	V
		+3 V	1.0		2.0	V
Common-Mode Rejection Ratio	Input Offset Voltage	$V_{\text{CM}} = 1.25\ \text{V to } 3.75\ \text{V}$	+5 V	54	58	dB
					3	6.5
-Input Current	$V_{\text{CM}} = 1\ \text{V to } 2\ \text{V}$	+3 V		0.1	0.2	$\mu\text{A}/\text{V}$
+Input Current				56		dB
Input Offset Voltage				3.5		$\mu\text{A}/\text{V}$
-Input Current				0.1		$\mu\text{A}/\text{V}$
+Input Current						$\mu\text{A}/\text{V}$
<b>OUTPUT CHARACTERISTICS</b>						
Output Voltage Swing p-p	$R_L = 150\ \Omega$ , $T_{\text{MIN}}-T_{\text{MAX}}$	+5 V +3 V	3.0	3.2		$\pm\text{V p-p}$
			1.0	1.3		$\pm\text{V p-p}$
Output Current		+5 V	20	30		mA
		+3 V	15	25		mA
Short Circuit Current	G = +2, $R_F = 715\ \Omega$ $V_{\text{IN}} = 1\ \text{V}$	+5 V		40		mA

Model	Conditions	V <sub>s</sub>	AD813A			Units
			Min	Typ	Max	
<b>MATCHING CHARACTERISTICS</b>						
Dynamic						
Crosstalk	G = +2, f = 5 MHz	+5 V, +3 V		-65		dB
Gain Flatness Match	G = +2, f = 20 MHz	+5 V, +3 V		0.1		dB
DC						
Input Offset Voltage	T <sub>MIN</sub> -T <sub>MAX</sub>	+5 V, +3 V		0.5	3.5	mV
-Input Bias Current	T <sub>MIN</sub> -T <sub>MAX</sub>	+5 V, +3 V		2	25	μA
<b>POWER SUPPLY</b>						
Operating Range			2.4		36	V
Quiescent Current	Per Amplifier	+5 V		3.2	4.0	mA
		+3 V		3.0	4.0	mA
	T <sub>MIN</sub> -T <sub>MAX</sub>	+5 V			5.0	mA
Quiescent Current, Powered Down	Per Amplifier	+5 V		0.4	0.6	mA
		+3 V		0.4	0.5	mA
Power Supply Rejection Ratio						
Input Offset Voltage	V <sub>s</sub> = +3.0 V to +30 V			76		dB
-Input Current				0.3		μA/V
+Input Current				0.005		μA/V
<b>DISABLE CHARACTERISTICS</b>						
Off Isolation	f = 5 MHz	+5 V, +3 V		-55		dB
Off Output Impedance	G = +1	+5 V, +3 V		13		pF
Channel-to-Channel	2 or 3 Channel	+5 V, +3 V		-65		dB
Isolation	Mux, f = 5 MHz					
Turn-On Time		+5 V, +3 V		100		ns
Turn-Off Time				80		ns
<b>TRANSISTOR COUNT</b>						
				111		

## NOTES

<sup>1</sup>Slew rate measurement is based on 10% to 90% rise time in the specified closed-loop gain.

<sup>2</sup>Single supply differential gain and phase are measured with the ac coupled circuit of Figure 52.

Specifications subject to change without notice.

## ABSOLUTE MAXIMUM RATINGS<sup>1</sup>

Supply Voltage . . . . . ±18 V

Internal Power Dissipation<sup>2</sup>

  Plastic (N) . . . . . 1.6 Watts

  Small Outline (R) . . . . . 1.0 Watts

Input Voltage (Common Mode) . . . . . ±V<sub>S</sub>

Differential Input Voltage . . . . . ±6 V

Output Short Circuit Duration

  . . . . . Observe Power Derating Curves

Storage Temperature Range N, R . . . . . -65°C to +125°C

Operating Temperature Range

  AD813A . . . . . -40°C to +85°C

Lead Temperature Range (Soldering 10 sec) . . . . . +300°C

## NOTES

<sup>1</sup>Stresses above those listed under Absolute Maximum Ratings may cause permanent damage to the device. This is a stress rating only; functional operation of the device at these or any other conditions above those indicated in the operational section of this specification is not implied. Exposure to absolute maximum rating conditions for extended periods may affect device reliability.

<sup>2</sup>Specification is for device in free air:

14-Lead Plastic DIP Package: θ<sub>JA</sub> = 75°C/W

14-Lead SOIC Package: θ<sub>JA</sub> = 120°C/W

## ORDERING GUIDE

Model	Temperature Range	Package Description	Package Options
AD813AN	-40°C to +85°C	14-Lead Plastic DIP	N-14
AD813AR-14	-40°C to +85°C	14-Lead Plastic SOIC	R-14
AD813ACHIPS	-40°C to +85°C	Die Form	
AD813AR-REEL		13" REEL	
AD813AR-REEL7		7" REEL	
5962-9559601M2A*	-55°C to +125°C	20-Lead LCC	

\*Refer to official DSCC drawing for tested specifications and pin configuration.

# AD813

## Maximum Power Dissipation

The maximum power that can be safely dissipated by the AD813 is limited by the associated rise in junction temperature. The maximum safe junction temperature for the plastic encapsulated parts is determined by the glass transition temperature of the plastic, about 150°C. Exceeding this limit temporarily may cause a shift in parametric performance due to a change in the stresses exerted on the die by the package. Exceeding a junction temperature of 175°C for an extended period can result in device failure.

While the AD813 is internally short circuit protected, this may not be enough to guarantee that the maximum junction temperature (150°C) is not exceeded under all conditions. To ensure proper operation, it is important to observe the derating curves.

It must also be noted that in (noninverting) gain configurations (with low values of gain resistor), a high level of input overdrive can result in a large input error current, which may result in a significant power dissipation in the input stage. This power must be included when computing the junction temperature rise due to total internal power.

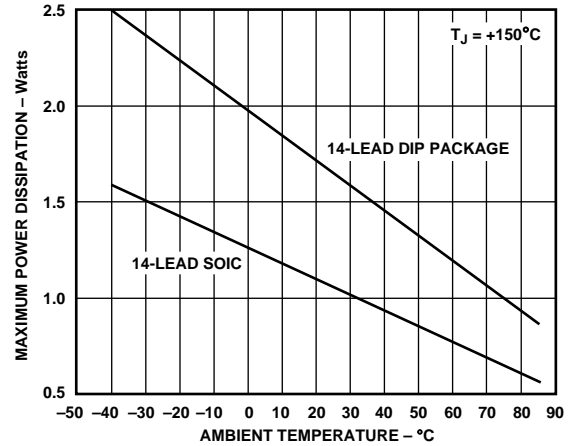
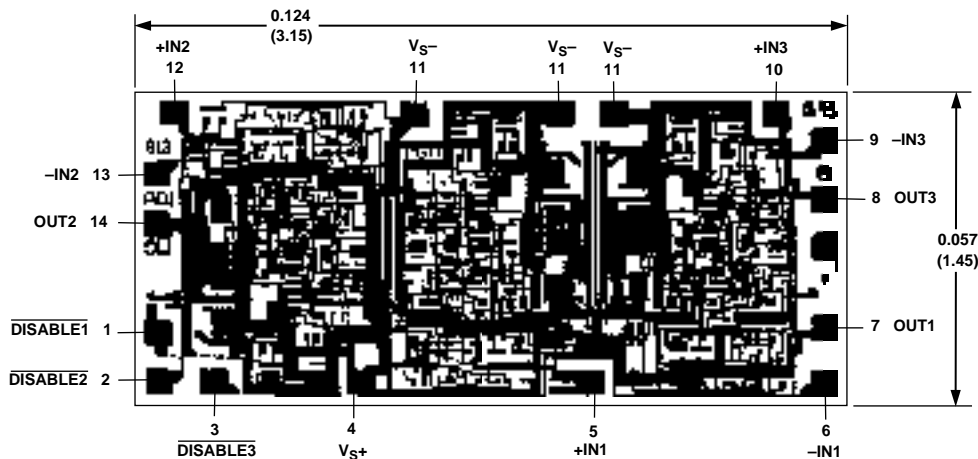

Figure 3. Maximum Power Dissipation vs. Ambient Temperature

## METALIZATION PHOTO

Dimensions shown in inches and (mm).



## CAUTION

ESD (electrostatic discharge) sensitive device. Electrostatic charges as high as 4000 V readily accumulate on the human body and test equipment and can discharge without detection. Although the AD813 features proprietary ESD protection circuitry, permanent damage may occur on devices subjected to high energy electrostatic discharges. Therefore, proper ESD precautions are recommended to avoid performance degradation or loss of functionality.



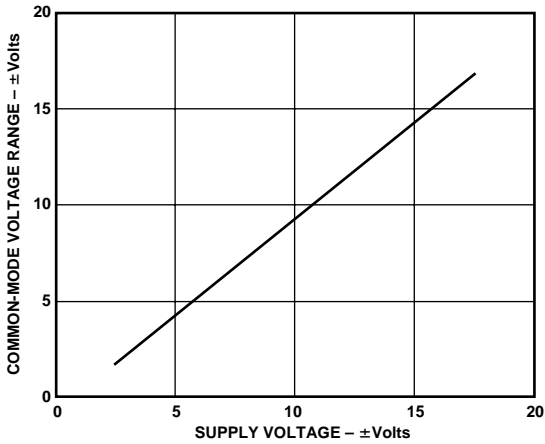

Figure 4. Input Common-Mode Voltage Range vs. Supply Voltage

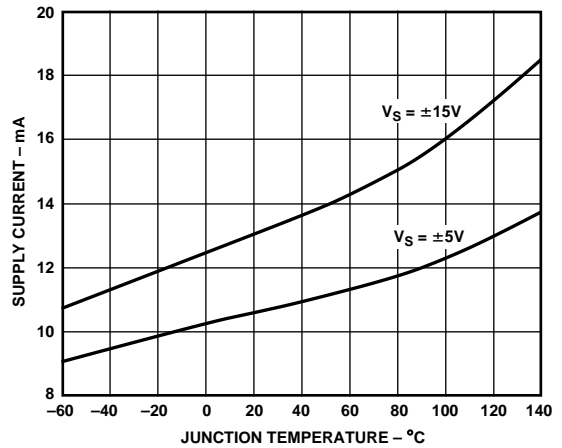

Figure 7. Supply Current vs. Junction Temperature

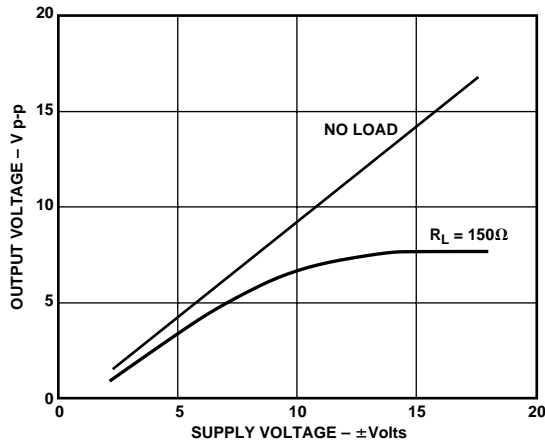

Figure 5. Output Voltage Swing vs. Supply Voltage

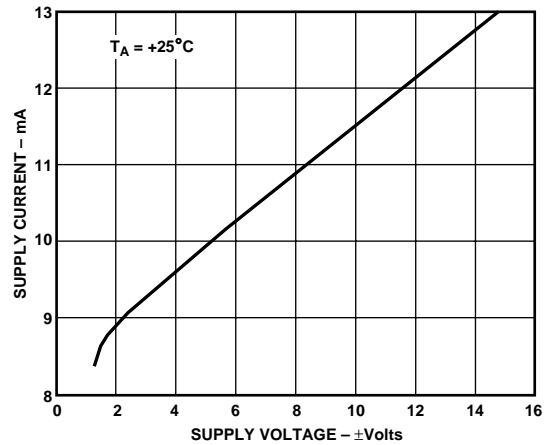

Figure 8. Supply Current vs. Supply Voltage at Low Voltages

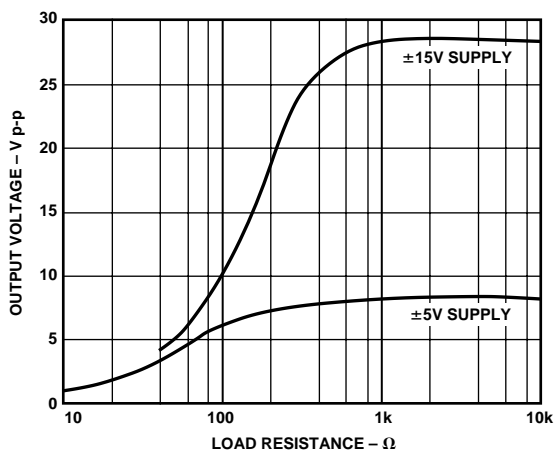

Figure 6. Output Voltage Swing vs. Load Resistance

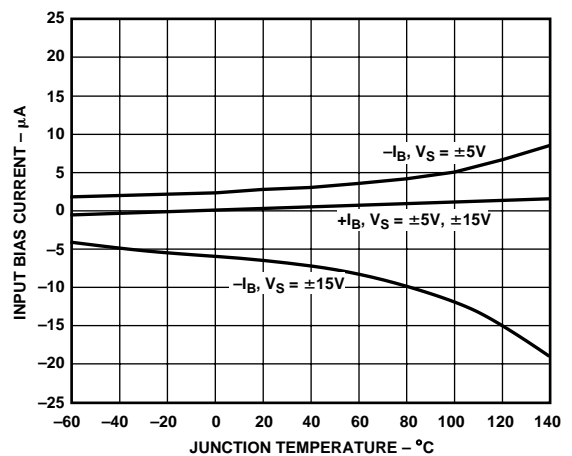

Figure 9. Input Bias Current vs. Junction Temperature

# AD813

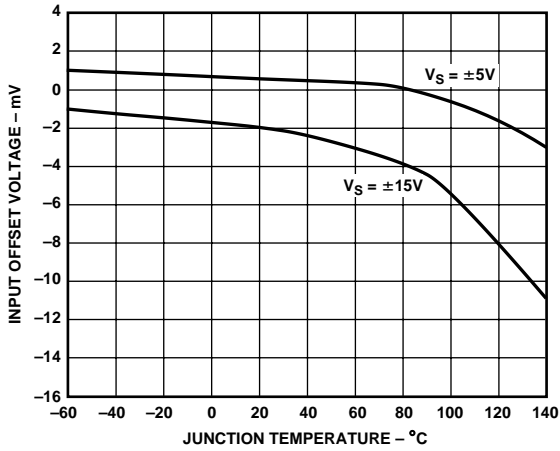

Figure 10. Input Offset Voltage vs. Junction Temperature

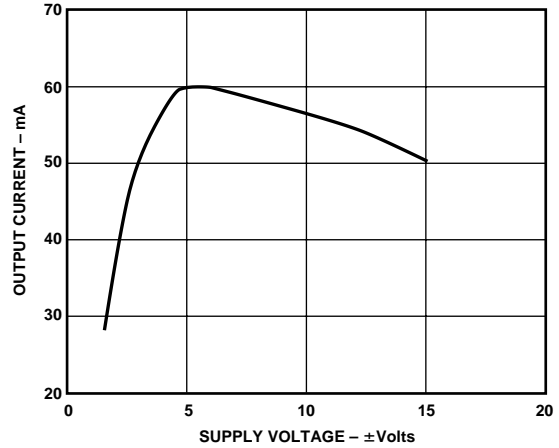

Figure 13. Linear Output Current vs. Supply Voltage

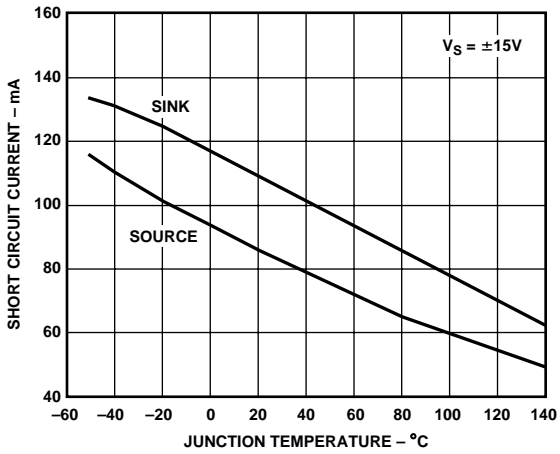

Figure 11. Short Circuit Current vs. Junction Temperature

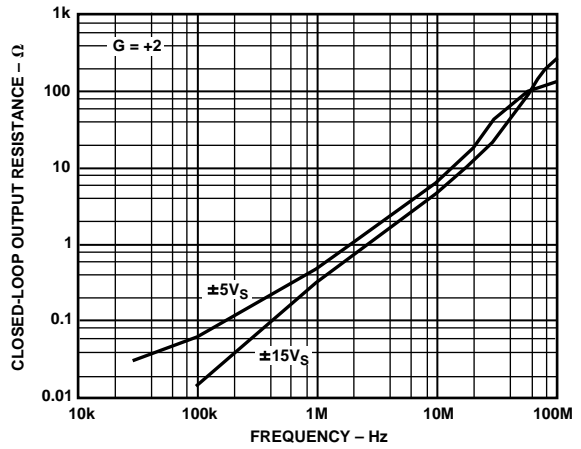

Figure 14. Closed-Loop Output Resistance vs. Frequency

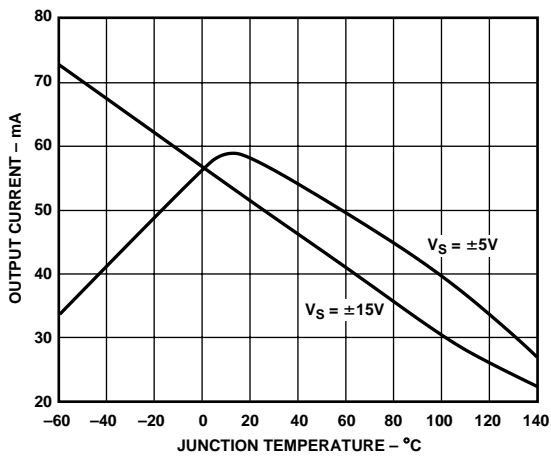

Figure 12. Linear Output Current vs. Junction Temperature

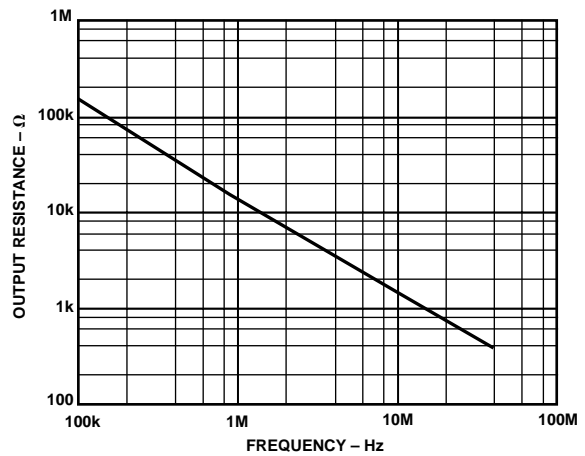

Figure 15. Output Resistance vs. Frequency, Disabled State



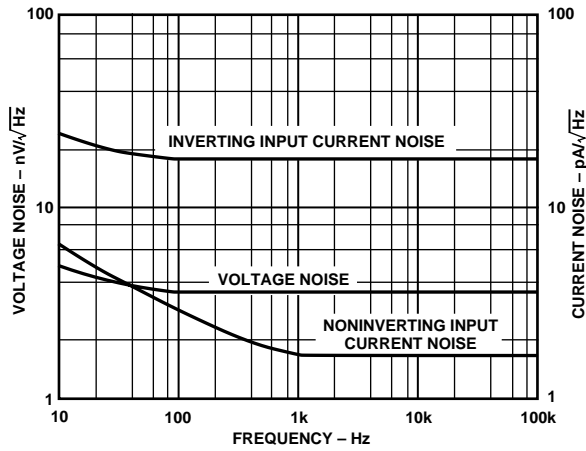

Figure 16. Input Current and Voltage Noise vs. Frequency

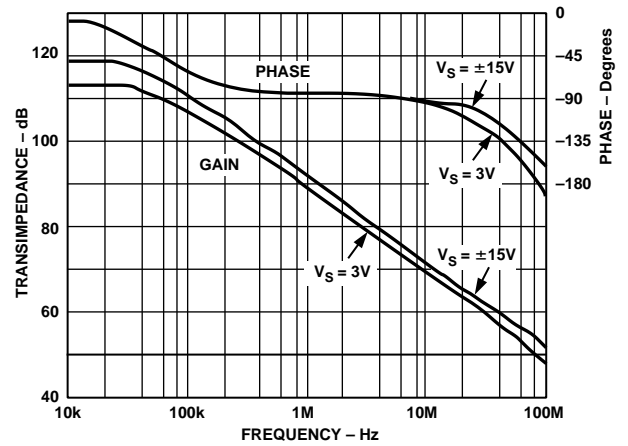

Figure 19. Open-Loop Transimpedance vs. Frequency (Relative to 1 Ω)

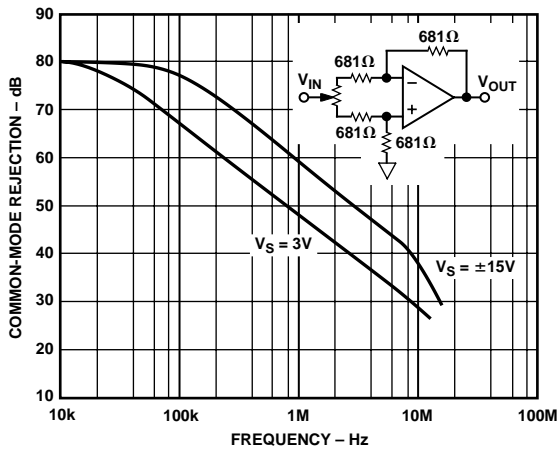

Figure 17. Common-Mode Rejection vs. Frequency

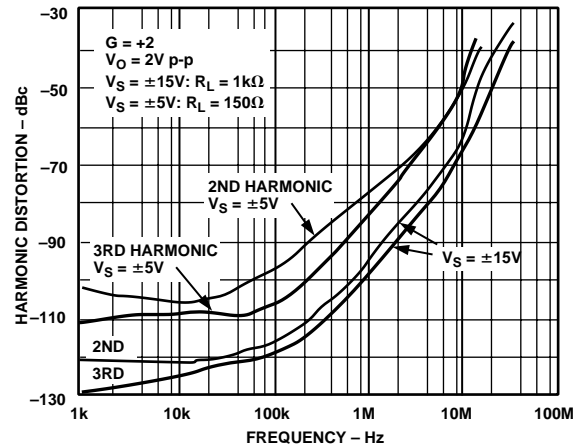

Figure 20. Harmonic Distortion vs. Frequency

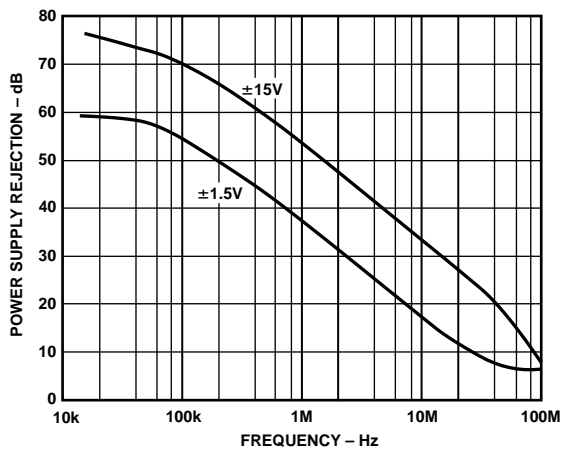

Figure 18. Power Supply Rejection vs. Frequency

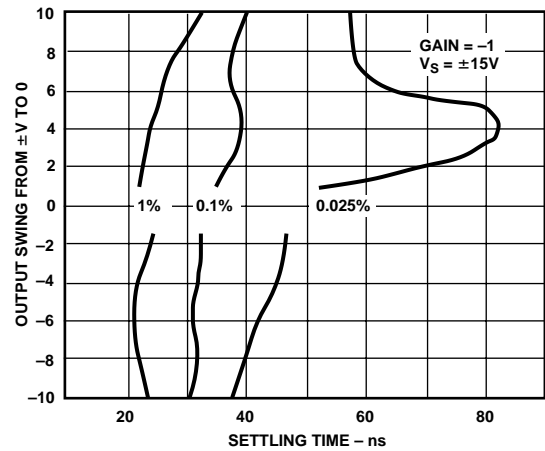

Figure 21. Output Swing and Error vs. Settling Time

# AD813

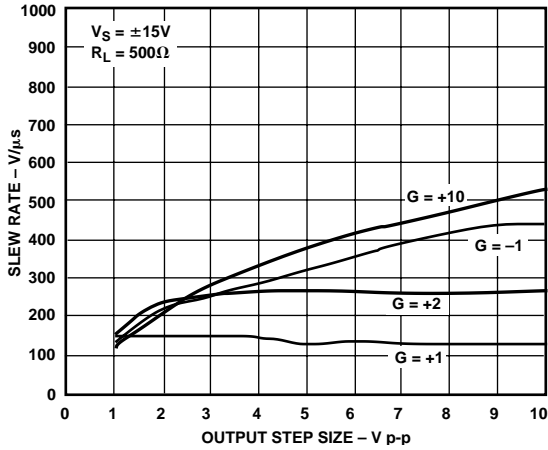

Figure 22. Slew Rate vs. Output Step Size

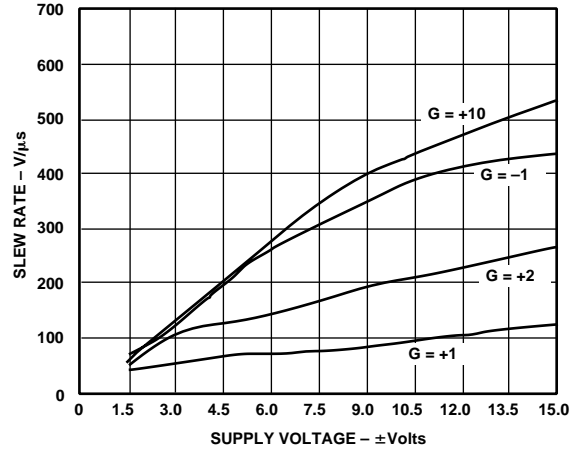

Figure 25. Maximum Slew Rate vs. Supply Voltage

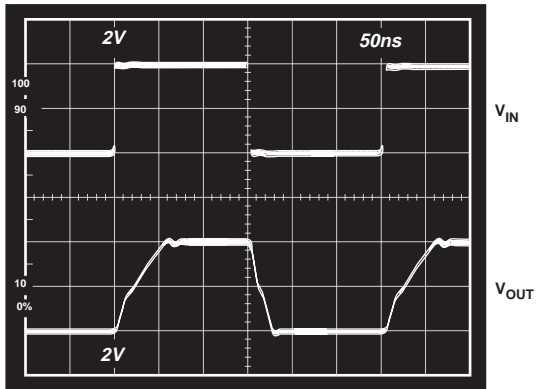

Figure 23. Large Signal Pulse Response, Gain = +1, ( $R_F = 750\ \Omega$ ,  $R_L = 150\ \Omega$ ,  $V_S = \pm 5\ V$ )

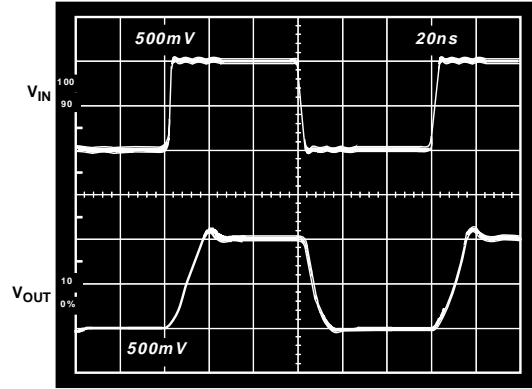

Figure 26. Small Signal Pulse Response, Gain = +1, ( $R_F = 750\ \Omega$ ,  $R_L = 150\ \Omega$ ,  $V_S = \pm 5\ V$ )

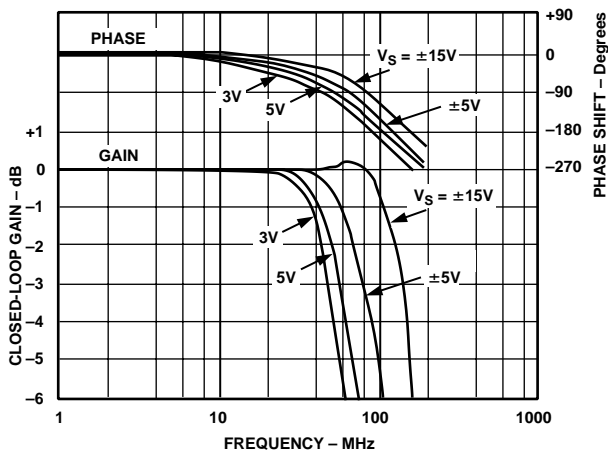

Figure 24. Closed-Loop Gain and Phase vs. Frequency,  $G = +1$

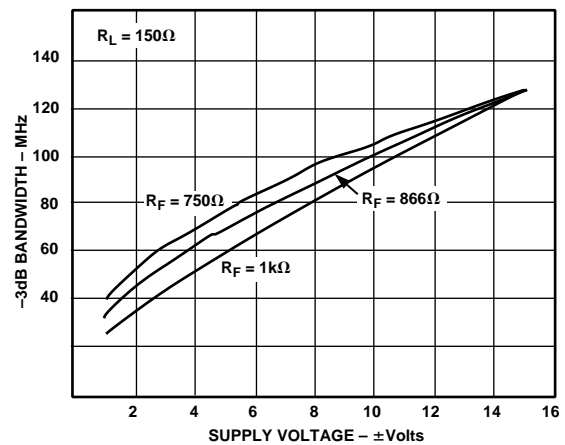

Figure 27. -3 dB Bandwidth vs. Supply Voltage,  $G = +1$

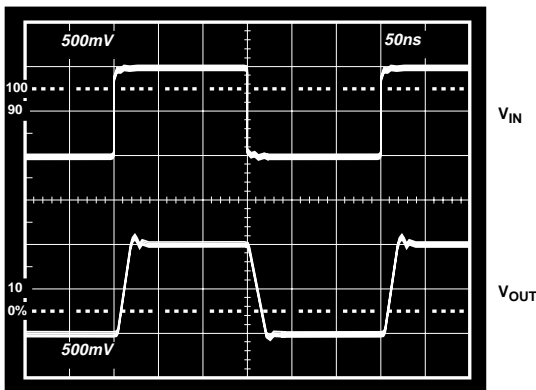

Figure 28. Large Signal Pulse Response, Gain = +10, ( $R_F = 357 \Omega$ ,  $R_L = 500 \Omega$ ,  $V_S = \pm 15 V$ )

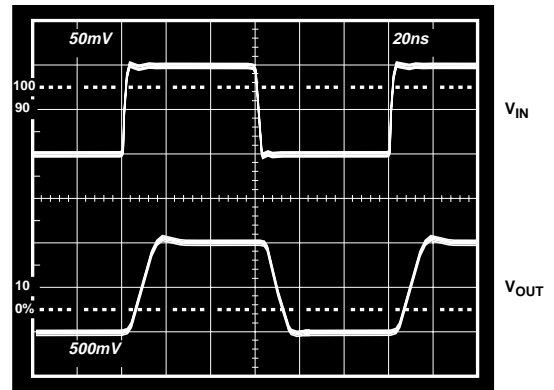

Figure 31. Small Signal Pulse Response, Gain = +10, ( $R_F = 357 \Omega$ ,  $R_L = 150 \Omega$ ,  $V_S = \pm 5 V$ )

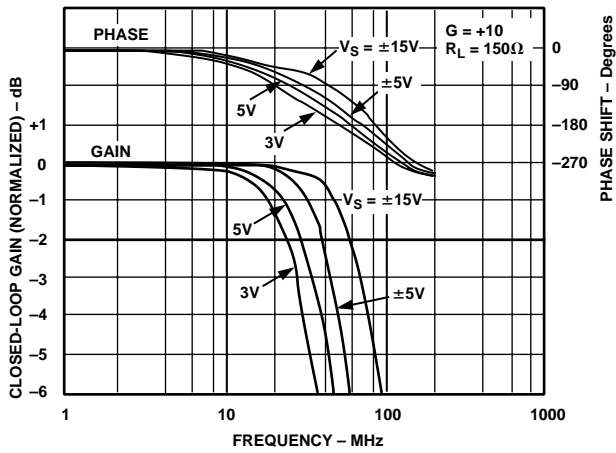

Figure 29. Closed-Loop Gain and Phase vs. Frequency,  $G = +10$ ,  $R_L = 150 \Omega$

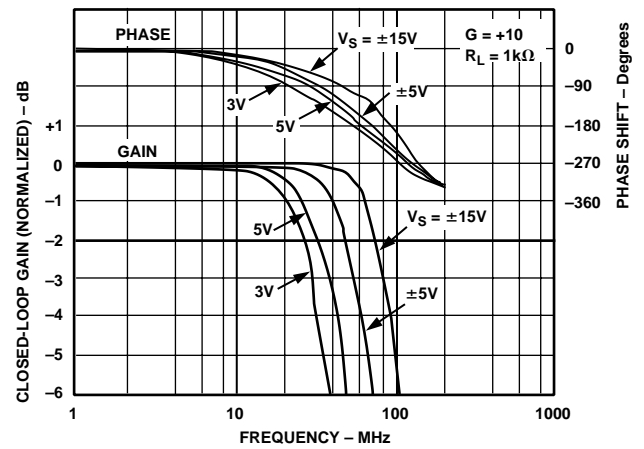

Figure 32. Closed-Loop Gain and Phase vs. Frequency,  $G = +10$ ,  $R_L = 1 k\Omega$

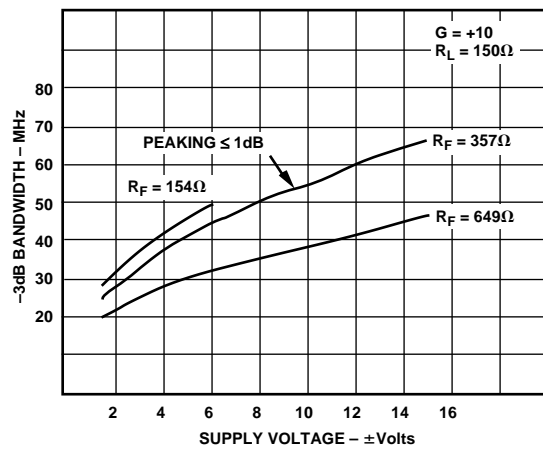

Figure 30. -3 dB Bandwidth vs. Supply Voltage,  $G = +10$ ,  $R_L = 150 \Omega$

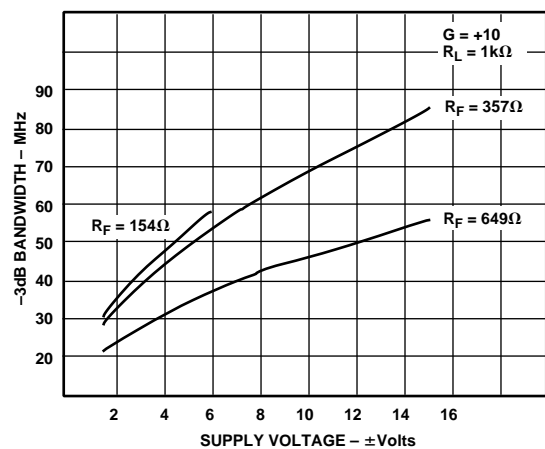

Figure 33. -3 dB Bandwidth vs. Supply Voltage,  $G = +10$ ,  $R_L = 1 k\Omega$

# AD813

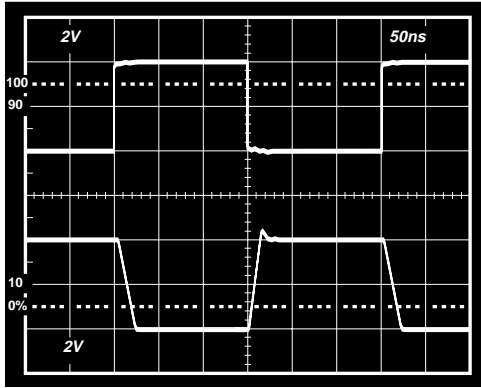

Figure 34. Large Signal Pulse Response, Gain = -1, ( $R_F = 750 \Omega$ ,  $R_L = 150 \Omega$ ,  $V_S = \pm 5 V$ )

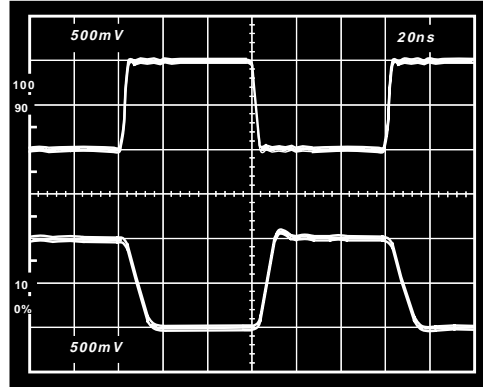

Figure 37. Small Signal Pulse Response, Gain = -1, ( $R_F = 750 \Omega$ ,  $R_L = 150 \Omega$ ,  $V_S = \pm 5 V$ )

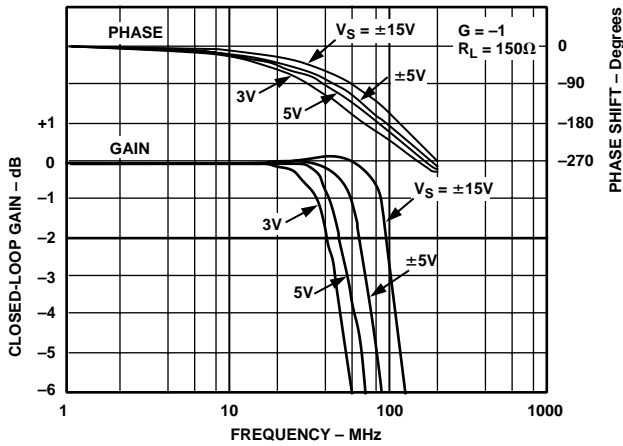

Figure 35. Closed-Loop Gain and Phase vs. Frequency,  $G = -1$ ,  $R_L = 150 \Omega$

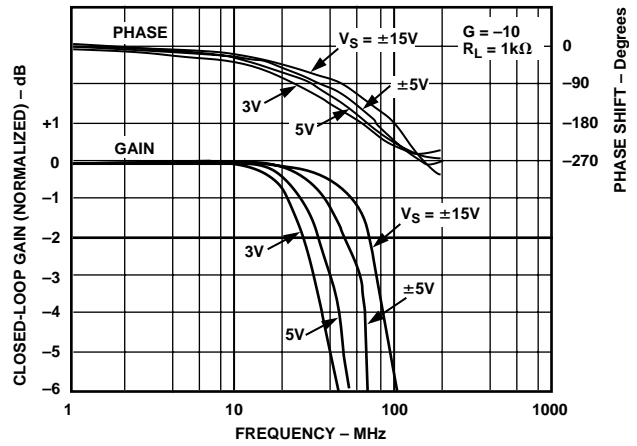

Figure 38. Closed-Loop Gain and Phase vs. Frequency,  $G = -10$ ,  $R_L = 1 k\Omega$

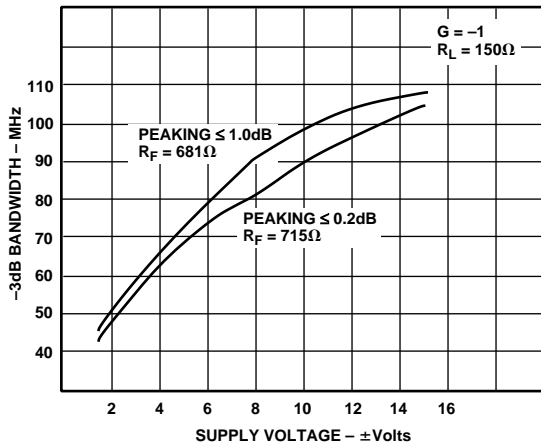

Figure 36. -3 dB Bandwidth vs. Supply Voltage,  $G = -1$ ,  $R_L = 150 \Omega$

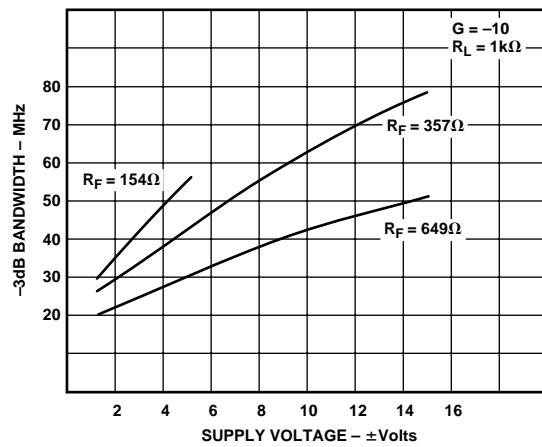

Figure 39. -3 dB Bandwidth vs. Supply Voltage,  $G = -10$ ,  $R_L = 1 k\Omega$

### General Consideration

The AD813 is a wide bandwidth, triple video amplifier that offers a high level of performance on less than 5.5 mA per amplifier of quiescent supply current. With its fast acting power down switch, it is designed to offer outstanding functionality and performance at closed-loop inverting or noninverting gains of one or greater.

Built on a low cost, complementary bipolar process, and achieving bandwidth in excess of 100 MHz, differential gain and phase errors of better than 0.1% and 0.1° (into 150 Ω), and output current greater than 40 mA, the AD813 is an exceptionally efficient video amplifier. Using a conventional current feedback architecture, its high performance is achieved through careful attention to design details.

### Choice of Feedback & Gain Resistors

Because it is a current feedback amplifier, the closed-loop bandwidth of the AD813 depends on the value of the feedback resistor. The bandwidth also depends on the supply voltage. In addition, attenuation of the open-loop response when driving load resistors less than about 250 Ω will also affect the bandwidth. Table I contains data showing typical bandwidths at different supply voltages for some useful closed-loop gains when driving a load of 150 Ω. (Bandwidths will be about 20% greater for load resistances above a few hundred ohms.)

**Table I. –3 dB Bandwidth vs. Closed-Loop Gain and Feedback Resistor, ( $R_L = 150 \Omega$ )**

$V_S$ (V)	Gain	$R_F$ (Ω)	BW (MHz)
±15	+1	866	125
	+2	681	100
	+10	357	60
	–1	681	100
	–10	357	55
±5	+1	750	75
	+2	649	65
	+10	154	40
	–1	649	70
	–10	154	40
+5	+1	715	60
	+2	619	50
	+10	154	30
	–1	619	50
	–10	154	30
+3	+1	681	50
	+2	619	40
	+10	154	25
	–1	619	40
	–10	154	20

The choice of feedback resistor is not critical unless it is important to maintain the widest, flattest frequency response. The resistors recommended in the table are those (metal film values) that will result in the widest 0.1 dB bandwidth. In those applications where the best control of the bandwidth is desired, 1% metal film resistors are adequate. Wider bandwidths can be attained by reducing the magnitude of the feedback resistor (at the expense of increased peaking), while peaking can be reduced by increasing the magnitude of the feedback resistor.

To estimate the –3 dB bandwidth for closed-loop gains or feedback resistors not listed in the above table, the following two pole model for the AD813 may be used:

$$A_{CL} = \frac{G}{S^2 \left[ \frac{(R_F + Gr_{IN}) C_T}{2\pi f_2} \right] + S(R_F + Gr_{IN}) C_T + 1}$$

where:  $A_{CL}$  = closed-loop gain from “transcapacitance”  
 $G = 1 + R_F/R_G$   
 $r_{IN}$  = input resistance of the inverting input  
 $C_T$  = “transcapacitance,” which forms the open-loop dominant pole with the transresistance  
 $R_F$  = feedback resistor  
 $R_G$  = gain resistor  
 $f_2$  = frequency of second (nondominant) pole  
 $s = 2\pi j f$

Appropriate values for the model parameters at different supply voltages are listed in Table II. Reasonable approximations for these values at supply voltages not found in the table can be obtained by a simple linear interpolation between those tabulated values which ‘bracket’ the desired condition.

**Table II. Two Pole Model Parameters at Various Supplies**

$V_S$ (V)	$r_{IN}$ (Ω)	$C_T$ (pF)	$f_2$ (MHz)
±15	85	2.5	150
±5	90	3.8	125
+5	105	4.8	105
+3	115	5.5	95

As discussed in many amplifier and electronics textbooks (such as Roberge’s *Operational Amplifiers: Theory and Practice*), the –3 dB bandwidth for the 2-pole model can be obtained as:

$$f_3 = f_n \left[ 1 - 2d^2 + (2 - 4d^2 + 4d^4)^{1/2} \right]^{1/2}$$

where:  $f_n = \left[ \frac{f_2}{(R_F + Gr_{IN}) C_T} \right]^{1/2}$

and:  $d = \frac{1}{2} \left[ f_2 (R_F + Gr_{IN}) C_T \right]^{1/2}$

This model will predict –3 dB bandwidth within about 10% to 15% of the correct value when the load is 150 Ω. However, it is not accurate enough to predict either the phase behavior or the frequency response peaking of the AD813.

# AD813

## Printed Circuit Board Layout Guidelines

As with all wideband amplifiers, printed circuit board parasitics can affect the overall closed-loop performance. Most important for controlling the 0.1 dB bandwidth are stray capacitances at the output and inverting input nodes. Increasing the space between signal lines and ground plane will minimize the coupling. Also, signal lines connecting the feedback and gain resistors should be kept short enough that their associated inductance does not cause high frequency gain errors.

## Power Supply Bypassing

Adequate power supply bypassing can be very important when optimizing the performance of high speed circuits. Inductance in the supply leads can (for example) contribute to resonant circuits that produce peaking in the amplifier's response. In addition, if large current transients must be delivered to a load, then large (greater than 1  $\mu\text{F}$ ) bypass capacitors are required to produce the best settling time and lowest distortion. Although 0.1  $\mu\text{F}$  capacitors may be adequate in some applications, more elaborate bypassing is required in other cases.

When multiple bypass capacitors are connected in parallel, it is important to be sure that the capacitors themselves do not form resonant circuits. A small (say 5  $\Omega$ ) resistor may be required in series with one of the capacitors to minimize this possibility.

As discussed below, power supply bypassing can have a significant impact on crosstalk performance.

## Achieving Low Crosstalk

Measured crosstalk from the output of Amplifier 2 to the input of Amplifier 1 of the AD813 is shown in Figure 40. All other crosstalk combinations, (from the output of one amplifier to the input of another), are a few dB better than this due to the additional distance between critical signal nodes.

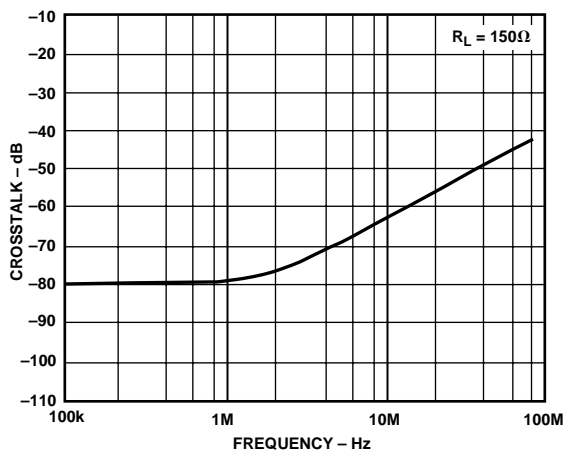

Figure 40. Worst Case Crosstalk vs. Frequency

A carefully laid-out PC board should be able to achieve the level of crosstalk shown in the figure. The most significant contributors to difficulty in achieving low crosstalk are inadequate power supply bypassing, overlapped input and/or output signal paths, and capacitive coupling between critical nodes.

The bypass capacitors must be connected to the ground plane at a point close to and between the ground reference points for the loads. (The bypass of the negative power supply is particularly important in this regard.) This requires careful planning as there are three amplifiers in the package, and low impedance signal return paths must be provided for each load. (Using a parallel combination of 1  $\mu\text{F}$ , 0.1  $\mu\text{F}$ , and 0.01  $\mu\text{F}$  bypass capacitors will help to achieve optimal crosstalk.)

The input and output signal return paths (to the bypass caps) must also be kept from overlapping. Since ground connections are not of perfectly zero impedance, current in one ground return path can produce a voltage drop in another ground return path if they are allowed to overlap.

Electric field coupling external to (and across) the package can be reduced by arranging for a narrow strip of ground plane to be run between the pins (parallel to the pin rows). Doing this on both sides of the board can reduce the high frequency crosstalk by about 5 dB or 6 dB.

## Driving Capacitive Loads

When used with the appropriate output series resistor, any load capacitance can be driven without peaking or oscillation. In most cases, less than 50  $\Omega$  is all that is needed to achieve an extremely flat frequency response. As illustrated in Figure 44, the AD813 can be very attractive for driving large capacitive loads. In this case, the AD813's high output short circuit current allows for a 150 V/ $\mu\text{s}$  slew rate when driving a 510 pF capacitor.

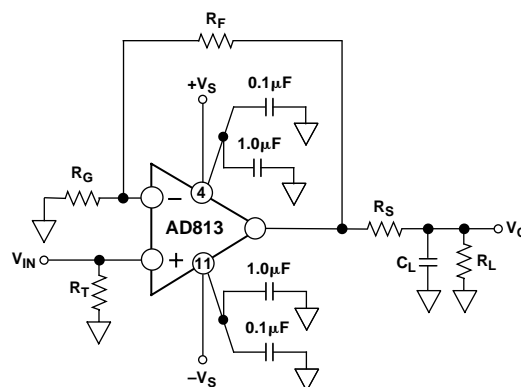

Figure 41. Circuit for Driving a Capacitive Load

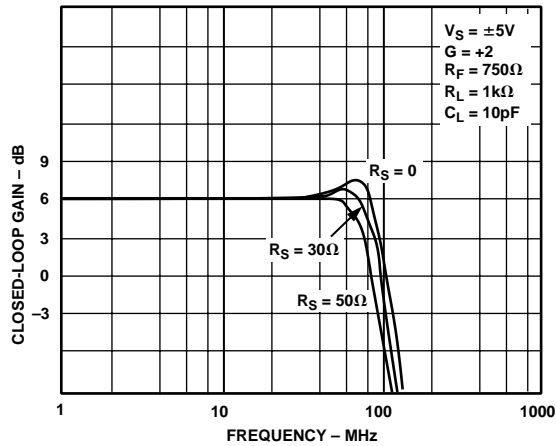

Figure 42. Response to a Small Load Capacitor at  $V_S = \pm 5\text{ V}$

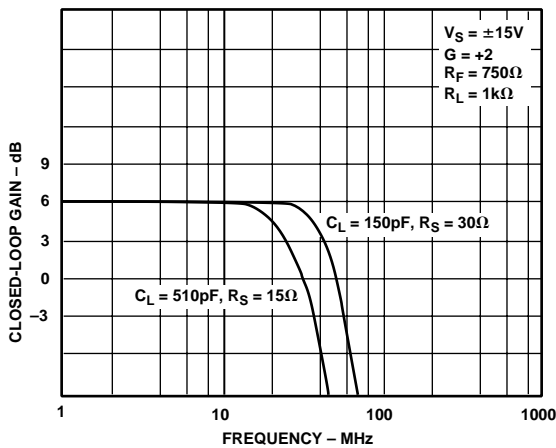

Figure 43. Response to a Large Load Capacitor at  $V_S = \pm 15\text{ V}$

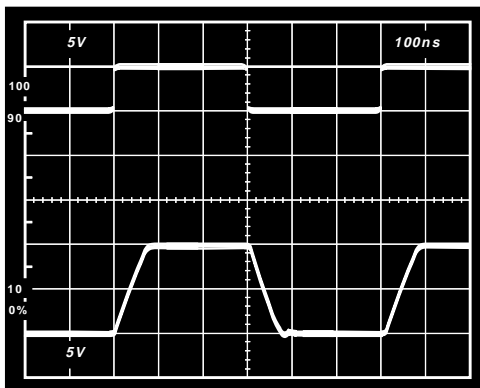

Figure 44. Circuit of Figure 38 Driving a 510 pF Load Capacitor,  $V_S = \pm 15\text{ V}$  ( $R_L = 1\text{ k}\Omega$ ,  $R_F = R_G = 750\ \Omega$ ,  $R_S = 15\ \Omega$ )

### Overload Recovery

There are three important overload conditions to consider. They are due to: input common-mode voltage overdrive, output voltage overdrive, and input current overdrive. When the amplifier is configured for low closed-loop gains, and the input common-mode voltage range is exceeded, the recovery time will be very fast, typically under 30 ns. When configured for a higher gain, and overloaded at the output, the recovery time will also be short. For example, in a gain of +10, with 6 dB of input overdrive, the recovery time of the AD813 is about 25 ns (see Figure 45).

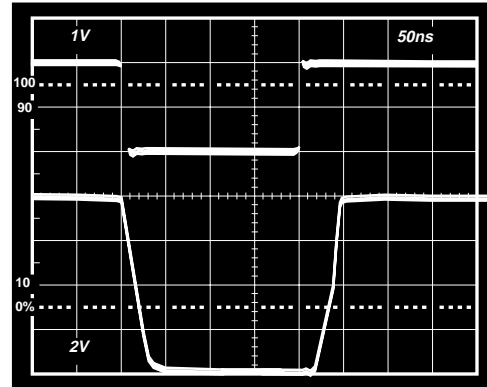

Figure 45. 6 dB Overload Recovery,  $G = +10$ , ( $R_L = 500\ \Omega$ ,  $R_F = 357\ \Omega$ ,  $V_S = \pm 5\text{ V}$ )

In the case of high gains with very high levels of input overdrive, a longer recovery time will occur. For example, if the input common-mode voltage range is exceeded in the gain of +10, the recovery time will be on the order of 100 ns. This is primarily due to current overloading of the input stage.

As noted in the warning under Maximum Power Dissipation, a high level of input overdrive in a high noninverting gain circuit can result in a large current flow in the input stage. Though this current is internally limited to about 40 mA, its effect on the total power dissipation may be significant.

# AD813

## High Performance Video Line Driver

At a gain of +2, the AD813 makes an excellent driver for a back terminated 75  $\Omega$  video line. Low differential gain and phase errors and wide 0.1 dB bandwidth can be realized over a wide range of power supply voltage. Excellent gain and group delay matching are also attainable over the full operating supply voltage range.

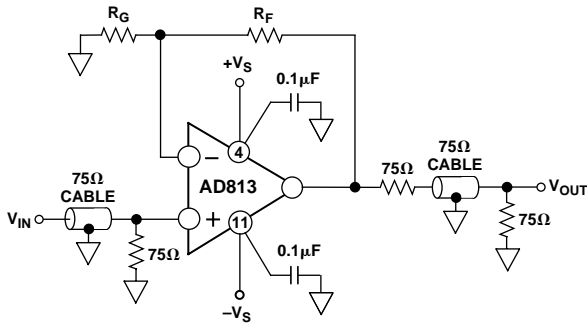

Figure 46. A Video Line Driver Operating at a Gain of +2 ( $R_F = R_G$  from Table I)

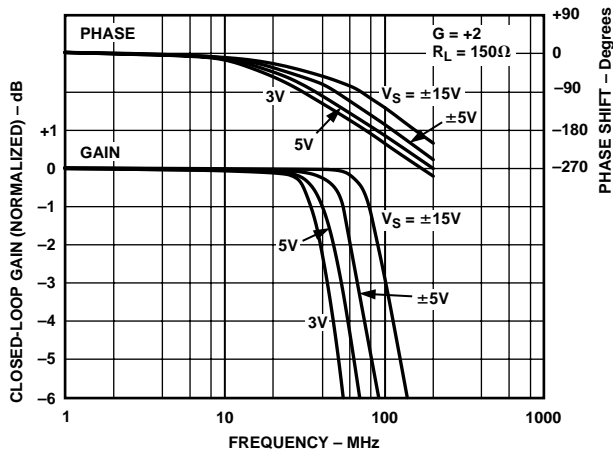

Figure 47. Closed-Loop Gain & Phase vs. Frequency for the Line Driver

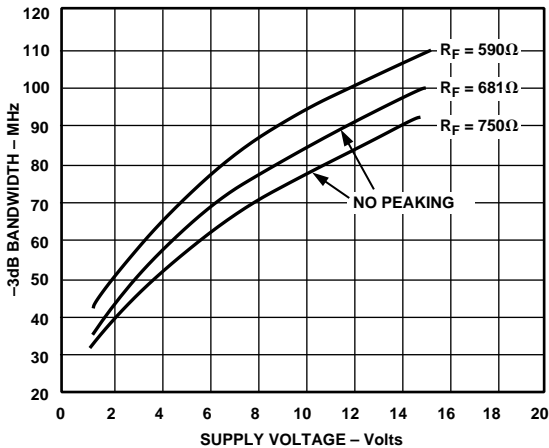

Figure 48. -3 dB Bandwidth vs. Supply Voltage for Gain = +2,  $R_L = 150 \Omega$

Figures 50 and 51 show the worst case matching; the match between amplifiers 2 and 3 is typically much better than this.

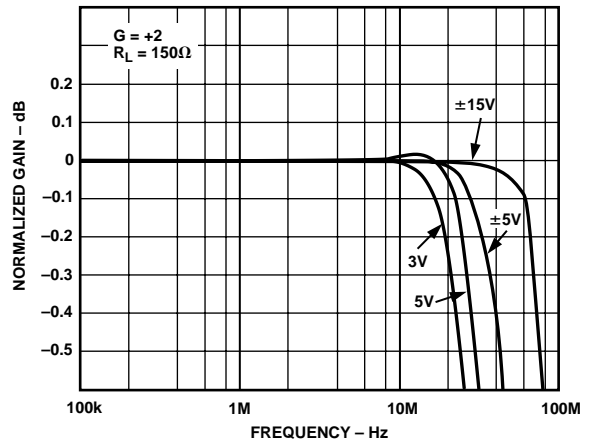

Figure 49. Fine-Scale Gain (Normalized) vs. Frequency

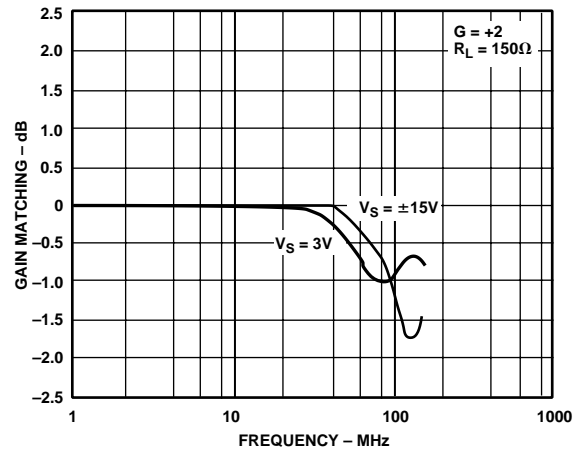

Figure 50. Closed-Loop Gain Matching vs. Frequency

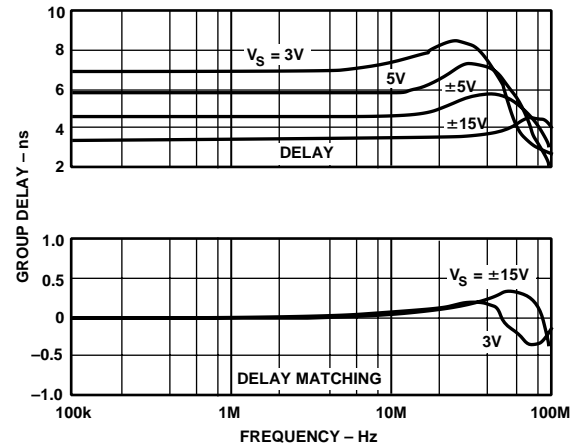

Figure 51. Group Delay and Group Delay Matching vs. Frequency,  $G = +2$ ,  $R_L = 150 \Omega$



**Operation Using a Single Supply**

The AD813 will operate with total supply voltages from 36 V down to 2.4 V. With proper biasing (see Figure 52) it can make an outstanding single supply video amplifier. Since the input and output voltage ranges extend to within 1 V of the supply rails, it will handle a 1.3 V peak-to-peak signal on a single 3.3 V supply, or a 3 V peak-to-peak signal on a single 5 V supply. The small signal 0.1 dB bandwidths will exceed 10 MHz in either case, and the large signal bandwidths will exceed 6 MHz.

The capacitively coupled cable driver in Figure 52 will achieve outstanding differential gain and phase errors of 0.05% and 0.05 degrees respectively on a single 5 V supply. Resistor R2, in this circuit, is selected to optimize the differential gain and phase by biasing the amplifier in its most linear region.

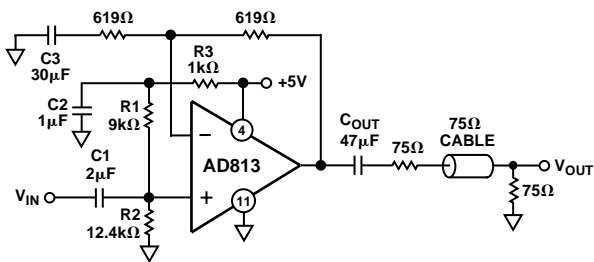

Figure 52. Biasing for Single Supply Operation

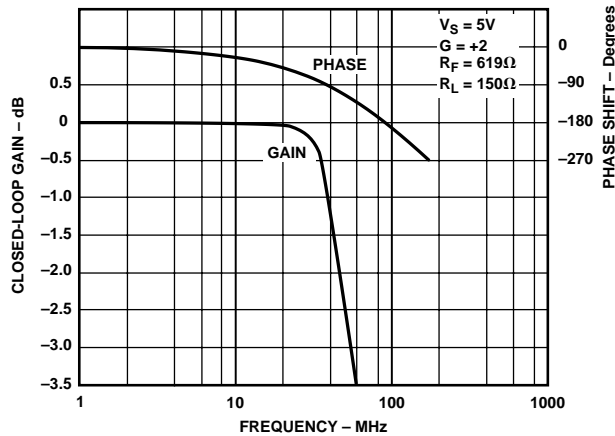

Figure 53. Closed-Loop Gain and Phase vs. Frequency, Circuit of Figure 52

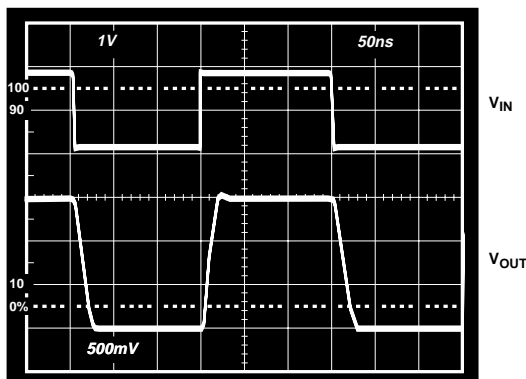

Figure 54. Pulse Response for the Circuit of Figure 52 with +VS = 5 V

**Disable Mode Operation**

Pulling the voltage on any one of the Disable pins about 2.5 V down from the positive supply will put the corresponding amplifier into a disabled, powered down, state. In this condition, the amplifier's quiescent supply current drops to about 0.5 mA, its output becomes a high impedance, and there is a high level of isolation from input to output. In the case of the gain of two line driver for example, the impedance at the output node will be about the same as for a 1.4 kΩ resistor (the feedback plus gain resistors) in parallel with a 12.5 pF capacitor and the input to output isolation will be about 65 dB at 1 MHz.

Leaving the Disable pin disconnected (floating) will leave the corresponding amplifier operational, in the enabled state. The input impedance of the disable pins is about 35 kΩ in parallel with a few pF. When grounded, about 50 μA flows out of a disable pin on ±5 V supplies.

Input voltages greater than about 1.5 V peak-to-peak will defeat the isolation. In addition, large signals (greater than 3 V peak-to-peak) applied to the output node will cause the output impedance to drop significantly.

When the Disable pins are driven by complementary output CMOS logic (such as the 74HC04), the disable time is about 80 ns (until the output goes high impedance) and the enable time is about 100 ns (to low impedance output) on ±15 V supplies. When operated on ±15 V supplies, the disable pins should be driven by open drain logic. In this case, pull-up resistors from the disable pins to the plus supply will ensure minimum switching time.

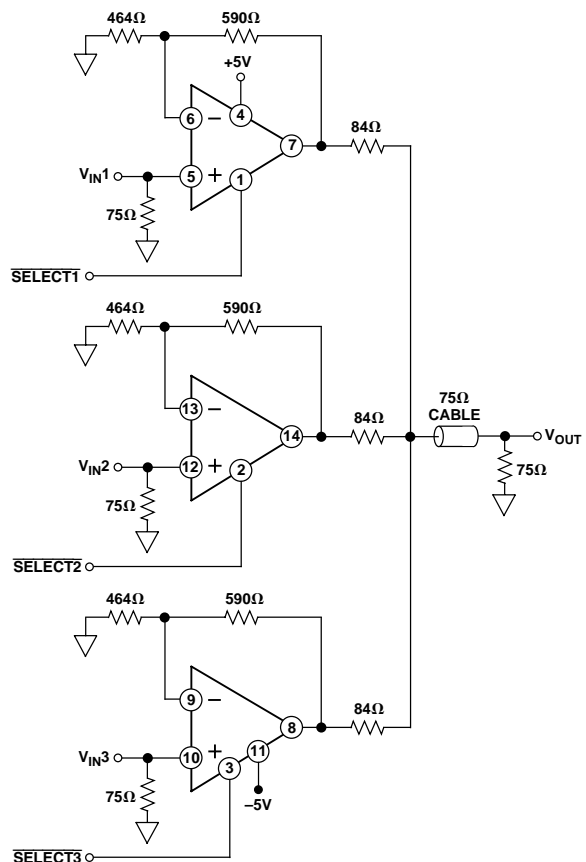

Figure 55. A Fast Switching 3:1 Video Mux (Supply Bypassing Not Shown)

# AD813

## 3:1 Video Multiplexer

Wiring the amplifier outputs together will form a 3:1 mux with outstanding gain flatness. Figure 55 shows a recommended configuration which results in  $-0.1$  dB bandwidth of 20 MHz and OFF channel isolation of 60 dB at 10 MHz on  $\pm 5$  V supplies. The time to switch between channels is about 180 ns. Switching time is only slightly affected by signal level.

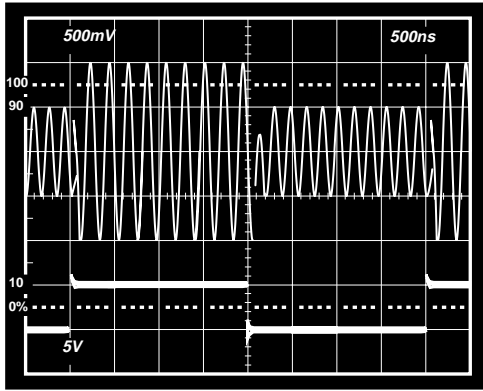

Figure 56. Channel Switching Characteristic for the 3:1 Mux

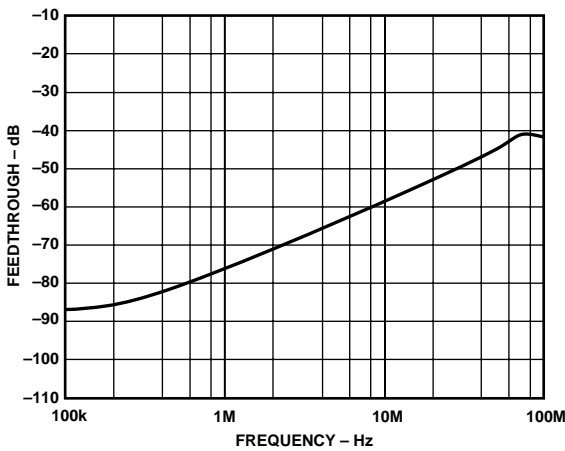

Figure 57. 3:1 Mux OFF Channel Feedthrough vs. Frequency

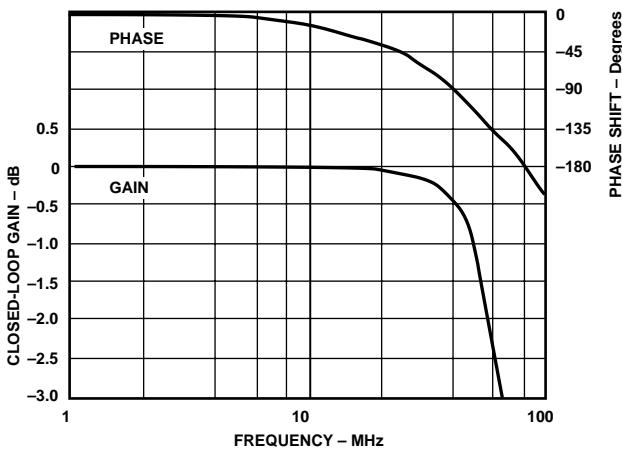

Figure 58. 3:1 Mux ON Channel Gain and Phase vs. Frequency

## Single Supply Differential Line Driver

Due to its outstanding overall performance on low supply voltages, the AD813 makes possible exceptional differential transmission on very low power. The circuit of Figure 59 will convert a single-ended, ground referenced signal to a differential signal whose common-mode reference is set to one half the supply voltage. This allows for a greater than 2 V peak-to-peak signal swing on a single 3 V power supply. A bandwidth over 30 MHz is achieved with 20 mA of output drive on only 30 mW of quiescent power (excluding load current).

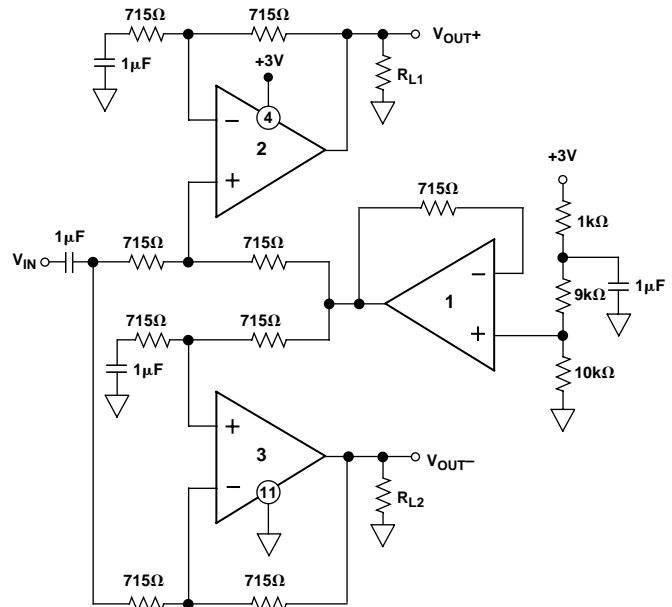

Figure 59. Single 3 V Supply Differential Line Driver with 2 V Swing

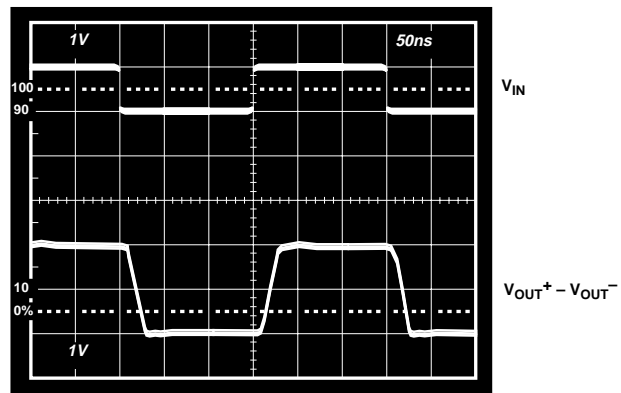
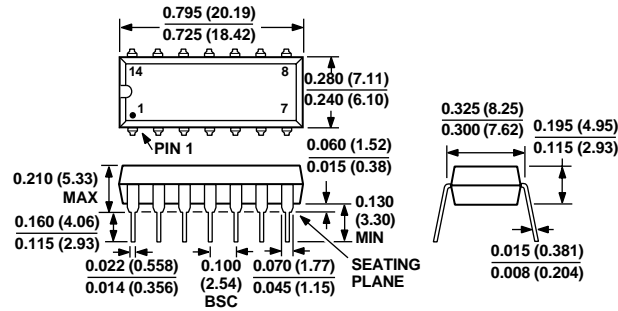

Figure 60. Differential Driver Pulse Response ( $V_S = 3$  V,  $R_{L1} = R_{L2} = 200 \Omega$ )

OUTLINE DIMENSIONS

Dimensions shown in inches and (mm).

14-Lead Plastic DIP  
(N-14)



14-Lead SOIC  
(R-14)

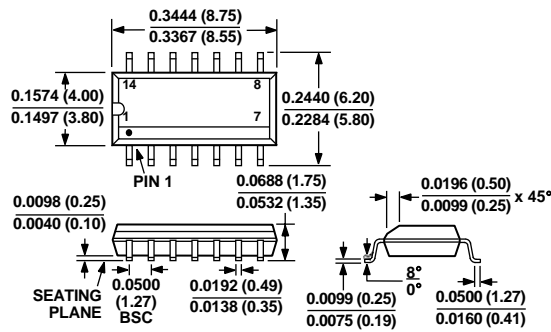

# Mouser Electronics

Authorized Distributor

Click to View Pricing, Inventory, Delivery & Lifecycle Information:

[Analog Devices Inc.:](#)

[AD813ARZ-14-REEL](#) [AD813ANZ](#) [AD813AR-14-EBZ](#) [5962-9559601M2A](#) [AD813ARZ-14](#) [AD813AR-14](#) [AD813ARZ-14-REEL7](#)