

FEATURES

With no external resistors

Difference amplifier: gains of 0.5, 1, or 2

Single ended amplifiers: over 40 different gains

Set reference voltage at midsupply

Excellent ac specifications

15 MHz bandwidth

30 V/ μ s slew rate

High accuracy dc performance

0.08% maximum gain error

10 ppm/ $^{\circ}$ C maximum gain drift

80 dB minimum CMRR (G = 2)

Two channels in small 4 mm \times 4 mm LFCSP

Supply current: 2.5 mA per channel

Supply range: \pm 2.5 V to \pm 18 V

APPLICATIONS

Instrumentation amplifier building blocks

Level translators

Automatic test equipment

High performance audio

Sine/cosine encoders

GENERAL DESCRIPTION

The AD8270 is a low distortion, dual-channel amplifier with internal gain setting resistors. With no external components, it can be configured as a high performance difference amplifier with gains of 0.5, 1, or 2. It can also be configured in over 40 single-ended configurations, with gains ranging from -2 to $+3$.

The AD8270 is the first dual-difference amplifier in the small 4 mm \times 4 mm LFCSP. It requires the same board area as a typical single-difference amplifier. The smaller package allows a $2\times$ increase in channel density and a lower cost per channel, all with no compromise in performance.

FUNCTIONAL BLOCK DIAGRAM

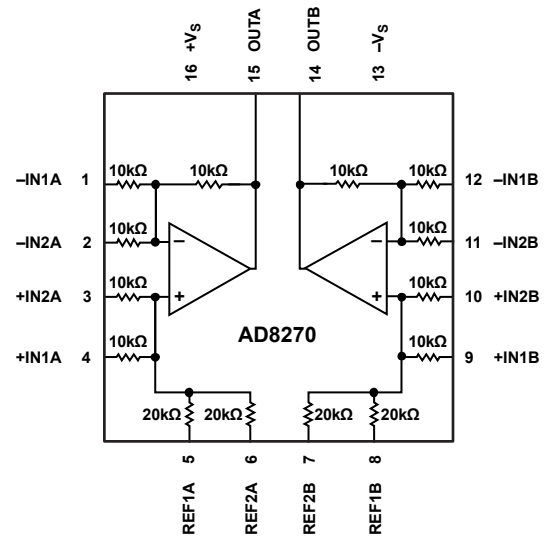

Figure 1.

The AD8270 operates on both single and dual supplies and requires only 2.5 mA maximum supply current for each amplifier. It is specified over the industrial temperature range of -40° C to $+85^{\circ}$ C and is fully RoHS compliant.

Table 1. Difference Amplifiers by Category

| High Speed | High Voltage | Single-Supply Unidirectional | Single-Supply Bidirectional |
|------------|--------------|------------------------------|-----------------------------|
| AD8270 | AD628 | AD8202 | AD8205 |
| AD8273 | AD629 | AD8203 | AD8206 |
| AMP03 | | | AD8216 |

TABLE OF CONTENTS

| | | | |
|--|----|---|----|
| Features | 1 | Circuit Information..... | 13 |
| Applications..... | 1 | Driving the AD8270..... | 13 |
| Functional Block Diagram | 1 | Package Considerations..... | 13 |
| General Description | 1 | Power Supplies..... | 13 |
| Revision History | 2 | Input Voltage Range..... | 14 |
| Specifications..... | 3 | Applications Information | 15 |
| Difference Amplifier Configurations | 3 | Difference Amplifier Configurations | 15 |
| Absolute Maximum Ratings..... | 5 | Single-Ended Configurations | 15 |
| Thermal Resistance | 5 | Differential Output | 17 |
| Maximum Power Dissipation | 5 | Driving an ADC | 18 |
| ESD Caution..... | 5 | Driving Cabling | 18 |
| Pin Configuration and Function Descriptions..... | 6 | Outline Dimensions | 19 |
| Typical Performance Characteristics | 7 | Ordering Guide | 19 |
| Theory of Operation | 13 | | |

REVISION HISTORY

5/2016—Rev. 0 to Rev. A

| | |
|--------------------------------------|----|
| Changes to Figure 3 and Table 6..... | 6 |
| Updated Outline Dimensions | 19 |
| Changes to Ordering Guide | 19 |

1/2008—Revision 0: Initial Version

SPECIFICATIONS

DIFFERENCE AMPLIFIER CONFIGURATIONS

$V_S = \pm 15\text{ V}$, $V_{REF} = 0\text{ V}$, $T_A = 25^\circ\text{C}$, $R_{LOAD} = 2\text{ k}\Omega$, specifications referred to input, unless otherwise noted.

Table 2.

| Parameter | Test Conditions/ Comments | G = 0.5 | | | G = 1 | | | G = 2 | | | Unit |
|-------------------------------------|--|---------|-------|-------|-------|-------|-------|-------|-----|------------------------------|------|
| | | Min | Typ | Max | Min | Typ | Max | Min | Typ | Max | |
| DYNAMIC PERFORMANCE | | | | | | | | | | | |
| Bandwidth | | | 20 | | 15 | | 10 | | | MHz | |
| Slew Rate | | | 30 | | 30 | | 30 | | | V/ μs | |
| Settling Time to 0.01% | 10 V step on output | | 700 | 800 | 700 | 800 | 700 | 800 | | ns | |
| Settling Time to 0.001% | 10 V step on output | | 750 | 900 | 750 | 900 | 750 | 900 | | ns | |
| NOISE/DISTORTION | | | | | | | | | | | |
| Harmonic Distortion | $f = 1\text{ kHz}$, $V_{OUT} = 10\text{ V p-p}$, $R_{LOAD} = 600\ \Omega$ | | 84 | | 145 | | 95 | | | dB | |
| Voltage Noise ¹ | $f = 0.1\text{ Hz to }10\text{ Hz}$ | | 2 | | 1.5 | | 1 | | | $\mu\text{V p-p}$ | |
| | $f = 1\text{ kHz}$ | | 52 | | 38 | | 26 | | | nV/ $\sqrt{\text{Hz}}$ | |
| GAIN | | | | | | | | | | | |
| Gain Error | | | | 0.08 | | 0.08 | | 0.08 | | % | |
| Gain Drift | $T_A = -40^\circ\text{C to }+85^\circ\text{C}$ | | 1 | 10 | 1 | 10 | 1 | 10 | | ppm/ $^\circ\text{C}$ | |
| INPUT CHARACTERISTICS | | | | | | | | | | | |
| Offset ² | | | 450 | 1500 | 300 | 1000 | 225 | 750 | | μV | |
| Average Temperature Drift | $T_A = -40^\circ\text{C to }+85^\circ\text{C}$ | | 3 | | 2 | | 1.5 | | | $\mu\text{V}/^\circ\text{C}$ | |
| Common-Mode Rejection Ratio | DC to 1 kHz | 70 | 86 | | 76 | 92 | 80 | 98 | | dB | |
| Power Supply Rejection Ratio | | | 2 | 10 | 2 | 10 | 2 | 10 | | $\mu\text{V}/\text{V}$ | |
| Input Voltage Range ³ | | -15.4 | | +15.4 | -15.4 | | +15.4 | -15.4 | | V | |
| Common-Mode Resistance ⁴ | | | 7.5 | | 10 | | 7.5 | | | k Ω | |
| Bias Current | | | | 500 | | 500 | | 500 | | nA | |
| OUTPUT CHARACTERISTICS | | | | | | | | | | | |
| Output Swing | $T_A = -40^\circ\text{C to }+85^\circ\text{C}$ | | -13.8 | +13.8 | -13.8 | +13.8 | -13.8 | +13.8 | | V | |
| | | | -13.7 | +13.7 | -13.7 | +13.7 | -13.7 | +13.7 | | V | |
| Short-Circuit Current Limit | Sourcing | | 100 | | 100 | | 100 | | | mA | |
| | Sinking | | 60 | | 60 | | 60 | | | mA | |
| POWER SUPPLY | | | | | | | | | | | |
| Supply Current (per Amplifier) | | | 2.3 | 2.5 | 2.3 | 2.5 | 2.3 | 2.5 | | mA | |
| | $T_A = -40^\circ\text{C to }+85^\circ\text{C}$ | | | 3 | | 3 | | 3 | | mA | |

¹ Includes amplifier voltage and current noise, as well as noise of internal resistors.

² Includes input bias and offset errors.

³ At voltages beyond the rails, internal ESD diodes begin to turn on. In some configurations, the input voltage range may be limited by the internal op amp (see the Input Voltage Range section for details).

⁴ Internal resistors are trimmed to be ratio matched but have $\pm 20\%$ absolute accuracy. Common-mode resistance was calculated with both inputs in parallel. Common-mode impedance at only one input is $2\times$ the resistance listed.

$V_S = \pm 5\text{ V}$, $V_{REF} = 0\text{ V}$, $T_A = 25^\circ\text{C}$, $R_{LOAD} = 2\text{ k}\Omega$, specifications referred to input, unless otherwise noted.

Table 3.

| Parameter | Test Conditions/ Comments | G = 0.5 | | | G = 1 | | | G = 2 | | | Unit |
|-------------------------------------|---|---------|-----|------|-------|-----|------|-------|-----|------|------------------------------|
| | | Min | Typ | Max | Min | Typ | Max | Min | Typ | Max | |
| DYNAMIC PERFORMANCE | | | | | | | | | | | |
| Bandwidth | | | 20 | | | 15 | | | 10 | | MHz |
| Slew Rate | | | 30 | | | 30 | | | 30 | | V/ μs |
| Settling Time to 0.01% | 5 V step on output | | 550 | 650 | | 550 | 650 | | 550 | 650 | ns |
| Settling Time to 0.001% | 5 V step on output | | 600 | 750 | | 600 | 750 | | 600 | 750 | ns |
| NOISE/DISTORTION | | | | | | | | | | | |
| Harmonic Distortion | $f = 1\text{ kHz}$, $V_{OUT} = 5\text{ V p-p}$, $R_{LOAD} = 600\ \Omega$ | | 101 | | | 141 | | | 112 | | dB |
| Voltage Noise ¹ | $f = 0.1\text{ Hz to }10\text{ Hz}$ | | 2 | | | 1.5 | | | 1 | | $\mu\text{V p-p}$ |
| | $f = 1\text{ kHz}$ | | 52 | | | 38 | | | 26 | | nV/ $\sqrt{\text{Hz}}$ |
| GAIN | | | | | | | | | | | |
| Gain Error | | | | 0.08 | | | 0.08 | | | 0.08 | % |
| Gain Drift | $T_A = -40^\circ\text{C to }+85^\circ\text{C}$ | | 1 | 10 | | 1 | 10 | | 1 | 10 | ppm/ $^\circ\text{C}$ |
| INPUT CHARACTERISTICS | | | | | | | | | | | |
| Offset ² | | | 450 | 1500 | | 300 | 1000 | | 225 | 750 | μV |
| Average Temperature Drift | $T_A = -40^\circ\text{C to }+85^\circ\text{C}$ | | 3 | | | 2 | | | 1.5 | | $\mu\text{V}/^\circ\text{C}$ |
| Common-Mode Rejection Ratio | DC to 1 kHz | 70 | 86 | | 76 | 92 | | 80 | 98 | | dB |
| Power Supply Rejection Ratio | | | 2 | 10 | | 2 | 10 | | 2 | 10 | dB |
| Input Voltage Range ³ | | -5.4 | | +5.4 | -5.4 | | +5.4 | -5.4 | | +5.4 | V |
| Common-Mode Resistance ⁴ | | | 7.5 | | | 10 | | | 7.5 | | k Ω |
| Bias Current | | | | 500 | | | 500 | | | 500 | nA |
| OUTPUT CHARACTERISTICS | | | | | | | | | | | |
| Output Swing | | -4 | | +4 | -4 | | +4 | -4 | | +4 | V |
| | $T_A = -40^\circ\text{C to }+85^\circ\text{C}$ | -3.9 | | +3.9 | -3.9 | | +3.9 | -3.9 | | +3.9 | V |
| Short-Circuit Current Limit | Sourcing | | 100 | | | 100 | | | 100 | | mA |
| | Sinking | | 60 | | | 60 | | | 60 | | mA |
| POWER SUPPLY | | | | | | | | | | | |
| Supply Current (per Amplifier) | | | 2.3 | 2.5 | | 2.3 | 2.5 | | 2.3 | 2.5 | mA |
| | $T_A = -40^\circ\text{C to }+85^\circ\text{C}$ | | | 3 | | | 3 | | | 3 | mA |

¹ Includes amplifier voltage and current noise, as well as noise of internal resistors.

² Includes input bias and offset errors.

³ At voltages beyond the rails, internal ESD diodes begin to turn on. In some configurations, the input voltage range may be limited by the internal op amp (see the Input Voltage Range section for details).

⁴ Internal resistors are trimmed to be ratio matched but have $\pm 20\%$ absolute accuracy. Common-mode resistance was calculated with both inputs in parallel. Common-mode impedance at only one input is $2\times$ the resistance listed.

ABSOLUTE MAXIMUM RATINGS

Table 4.

| Parameter | Rating |
|--|---|
| Supply Voltage | ± 18 V |
| Output Short-Circuit Current | See derating curve in Figure 2 |
| Input Voltage Range | $\pm V_s$ |
| Storage Temperature Range | -65°C to $+130^{\circ}\text{C}$ |
| Specified Temperature Range | -40°C to $+85^{\circ}\text{C}$ |
| Package Glass Transition Temperature (T_G) | 130°C |
| ESD | |
| Human Body Model | 1 kV |
| Charge Device Model | 1 kV |
| Machine Model | 0.1 kV |

Stresses at or above those listed under Absolute Maximum Ratings may cause permanent damage to the product. This is a stress rating only; functional operation of the product at these or any other conditions above those indicated in the operational section of this specification is not implied. Operation beyond the maximum operating conditions for extended periods may affect product reliability.

THERMAL RESISTANCE

Table 5. Thermal Resistance

| Thermal Pad | θ_{JA} | Unit |
|--|---------------|-----------------------------|
| 16-Lead LFCSP with Thermal Pad Soldered to Board | 57 | $^{\circ}\text{C}/\text{W}$ |
| 16-Lead LFCSP with Thermal Pad Not Soldered to Board | 96 | $^{\circ}\text{C}/\text{W}$ |

The θ_{JA} values in Table 5 assume a 4-layer JEDEC standard board with zero airflow. If the thermal pad is soldered to the board, it is also assumed it is connected to a plane. θ_{JC} at the exposed pad is $9.7^{\circ}\text{C}/\text{W}$.

MAXIMUM POWER DISSIPATION

The maximum safe power dissipation for the AD8270 is limited by the associated rise in junction temperature (T_J) on the die. At approximately 130°C , which is the glass transition temperature, the plastic changes its properties. Even temporarily exceeding this temperature limit may change the stresses that the package exerts on the die, permanently shifting the parametric performance of the amplifiers. Exceeding a temperature of 130°C for an extended period of time can result in a loss of functionality.

The AD8270 has built-in, short-circuit protection that limits the output current to approximately 100 mA (see Figure 19 for more information). While the short-circuit condition itself does not damage the device, the heat generated by the condition can cause the device to exceed its maximum junction temperature, with corresponding negative effects on reliability.

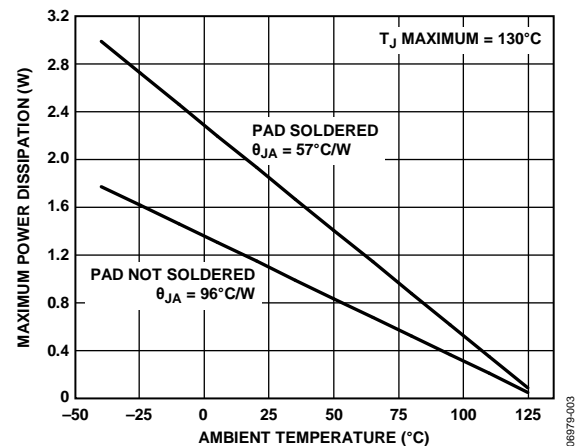

Figure 2. Maximum Power Dissipation vs. Ambient Temperature

ESD CAUTION



ESD (electrostatic discharge) sensitive device.

Charged devices and circuit boards can discharge without detection. Although this product features patented or proprietary protection circuitry, damage may occur on devices subjected to high energy ESD. Therefore, proper ESD precautions should be taken to avoid performance degradation or loss of functionality.

PIN CONFIGURATION AND FUNCTION DESCRIPTIONS

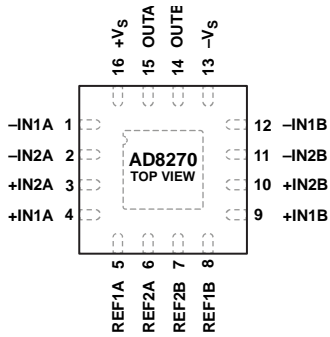

NOTES
1. TIE THE EXPOSED PAD TO $-V_S$.

06979-002

Figure 3. Pin Configuration

Table 6. Pin Function Descriptions

| Pin No. | Mnemonic | Description |
|---------|----------|---|
| 1 | -IN1A | 10 k Ω Resistor Connected to Negative Terminal of Op Amp A. |
| 2 | -IN2A | 10 k Ω Resistor Connected to Negative Terminal of Op Amp A. |
| 3 | +IN2A | 10 k Ω Resistor Connected to Positive Terminal of Op Amp A. |
| 4 | +IN1A | 10 k Ω Resistor Connected to Positive Terminal of Op Amp A. |
| 5 | REF1A | 20 k Ω Resistor Connected to Positive Terminal of Op Amp A. Most configurations use this pin as a reference voltage input. |
| 6 | REF2A | 20 k Ω Resistor Connected to Positive Terminal of Op Amp A. Most configurations use this pin as a reference voltage input. |
| 7 | REF2B | 20 k Ω Resistor Connected to Positive Terminal of Op Amp B. Most configurations use this pin as a reference voltage input. |
| 8 | REF1B | 20 k Ω Resistor Connected to Positive Terminal of Op Amp B. Most configurations use this pin as a reference voltage input. |
| 9 | +IN1B | 10 k Ω Resistor Connected to Positive Terminal of Op Amp B. |
| 10 | +IN2B | 10 k Ω Resistor Connected to Positive Terminal of Op Amp B. |
| 11 | -IN2B | 10 k Ω Resistor Connected to Negative Terminal of Op Amp B. |
| 12 | -IN1B | 10 k Ω Resistor Connected to Negative Terminal of Op Amp B. |
| 13 | $-V_S$ | Negative Supply. |
| 14 | OUTB | Op Amp B Output. |
| 15 | OUTA | Op Amp A Output. |
| 16 | $+V_S$ | Positive Supply. |
| 0 | EPAD | Exposed Pad. Tie the exposed pad to $-V_S$. |

TYPICAL PERFORMANCE CHARACTERISTICS

$V_S = \pm 15\text{ V}$, $T_A = 25^\circ\text{C}$, difference amplifier configuration, unless otherwise noted.

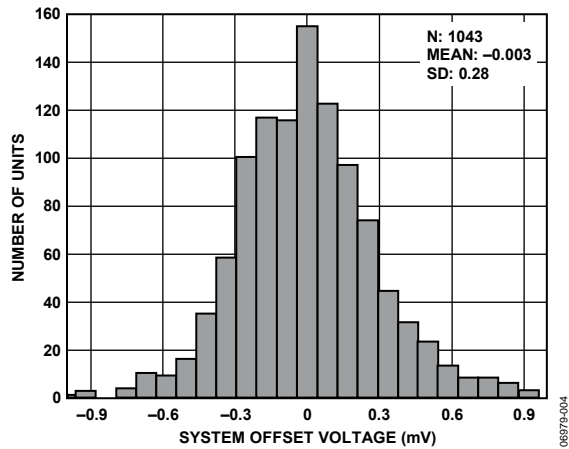

Figure 4. Typical Distribution of System Offset Voltage, $G = 1$

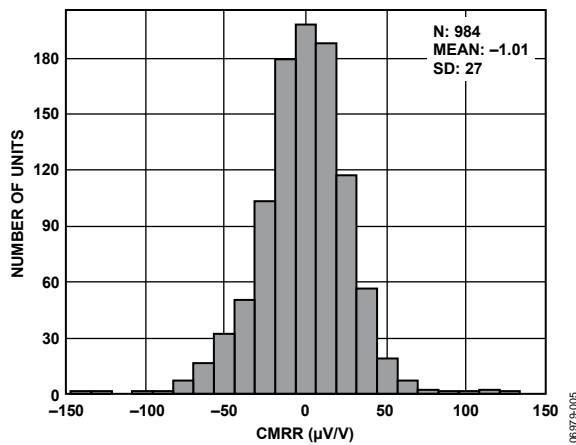

Figure 5. Typical Distribution of CMRR, $G = 1$

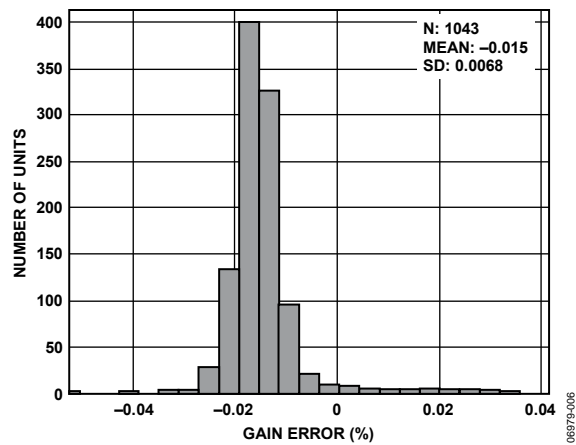

Figure 6. Typical Distribution of Gain Error, $G = 1$

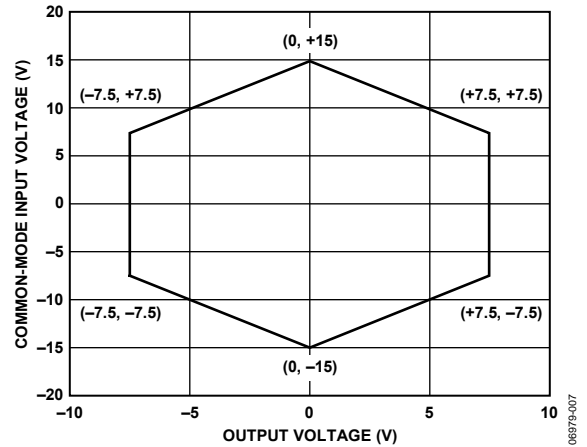

Figure 7. Common-Mode Input Voltage vs. Output Voltage, Gain = 0.5, $\pm 15\text{ V}$ Supplies

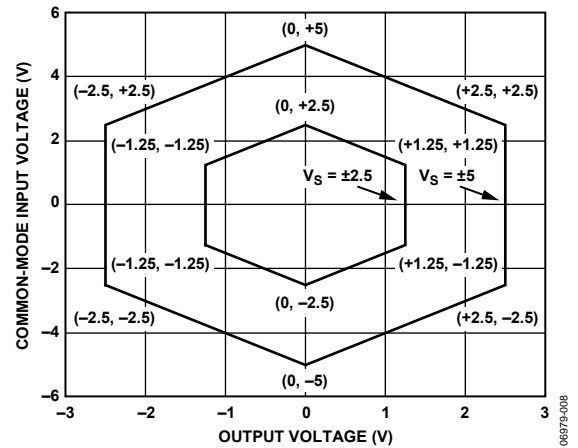

Figure 8. Common-Mode Input Voltage vs. Output Voltage, Gain = 0.5, $\pm 5\text{ V}$ and $\pm 2.5\text{ V}$ Supplies

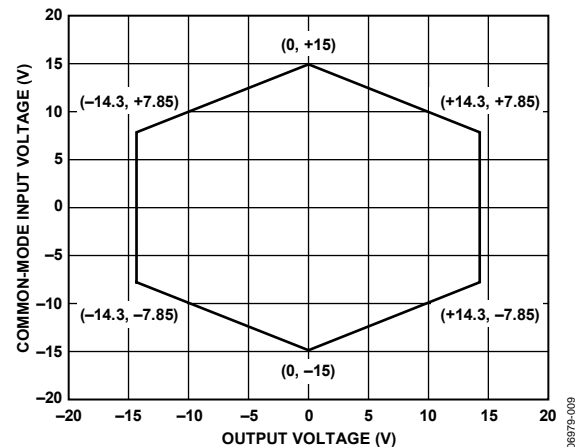

Figure 9. Common-Mode Input Voltage vs. Output Voltage, Gain = 1, $\pm 15\text{ V}$ Supplies

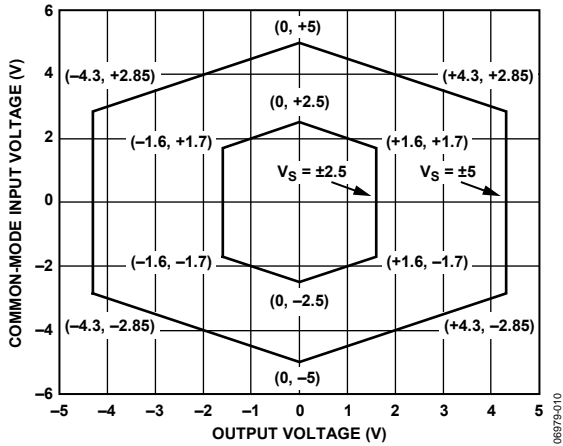

Figure 10. Common-Mode Input Voltage vs. Output Voltage, Gain = 1, ± 5 V and ± 2.5 V Supplies

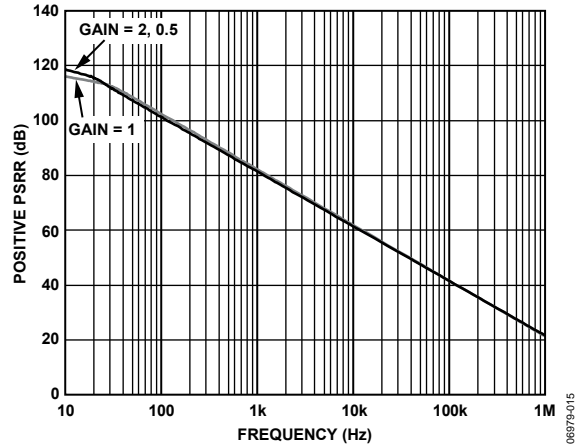

Figure 13. Positive PSRR vs. Frequency

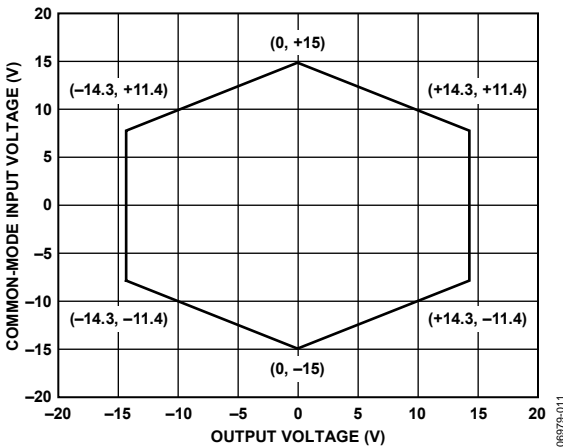

Figure 11. Common-Mode Input Voltage vs. Output Voltage, Gain = 2, ± 15 V Supplies

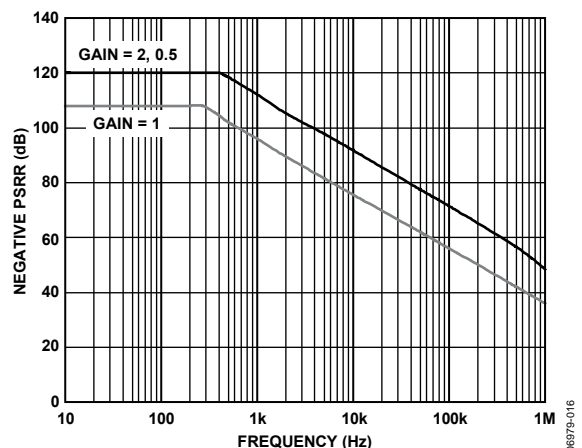

Figure 14. Negative PSRR vs. Frequency

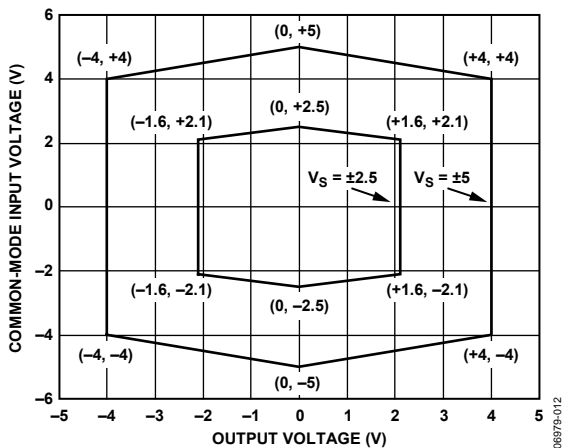

Figure 12. Common-Mode Input Voltage vs. Output Voltage, Gain = 2, ± 5 V and ± 2.5 V Supplies

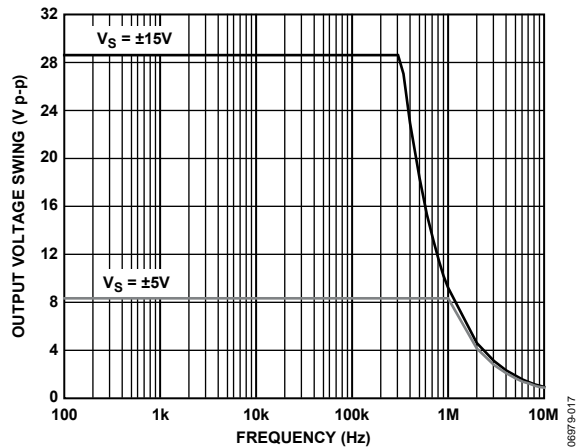

Figure 15. Output Voltage Swing vs. Large Signal Frequency Response

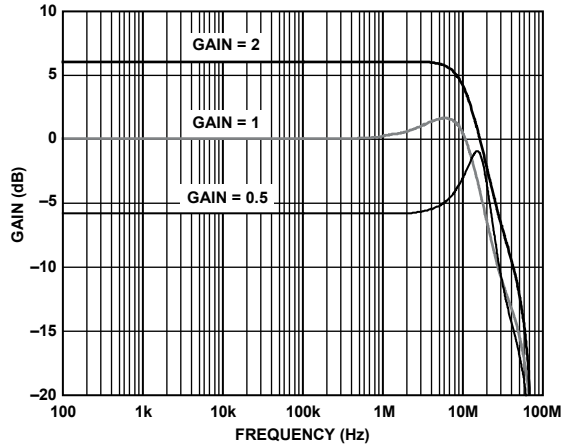

Figure 16. Gain vs. Frequency

06879-018

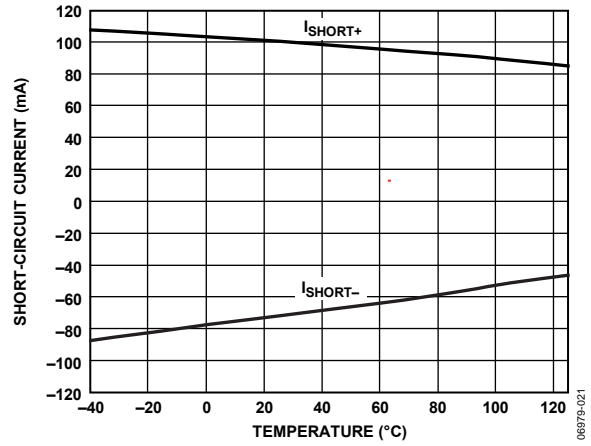

Figure 19. Short-Circuit Current vs. Temperature

06879-021

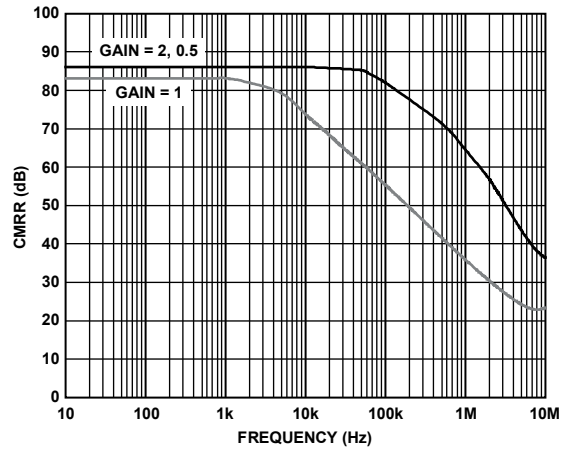

Figure 17. CMRR vs. Frequency

06879-019

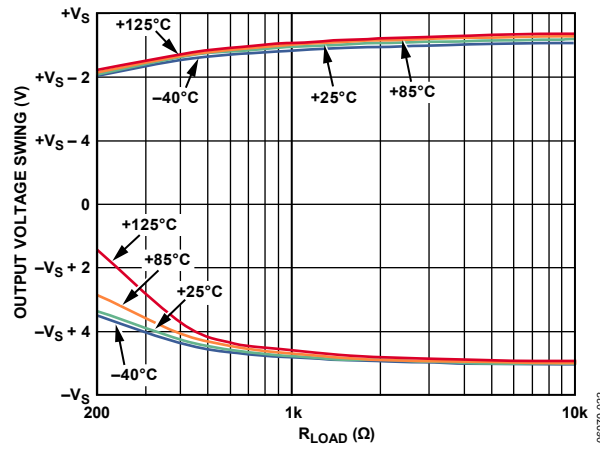

Figure 20. Output Voltage Swing vs. R_{LOAD}

06879-022

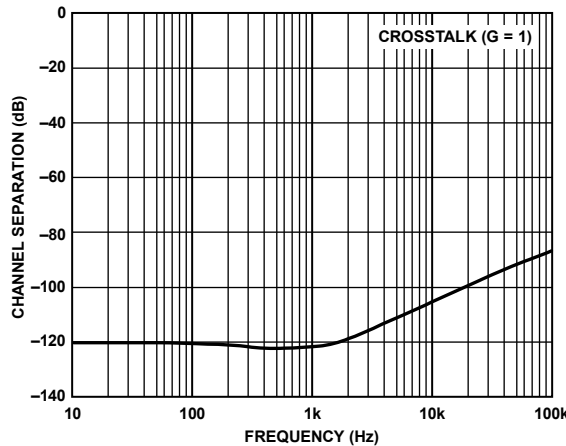

Figure 18. Channel Separation vs. Frequency

06879-013

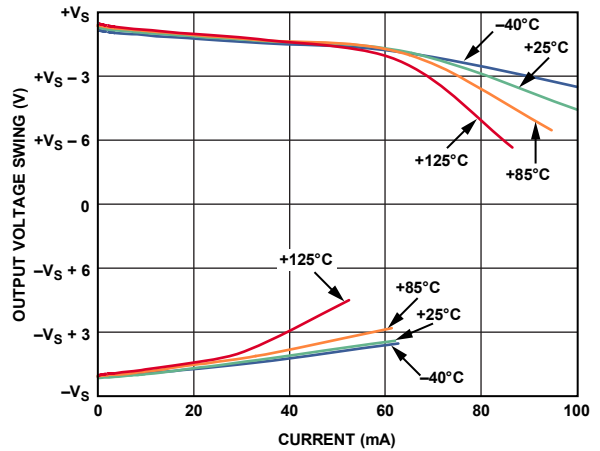

Figure 21. Output Voltage Swing vs. Current (I_{OUT})

06879-023

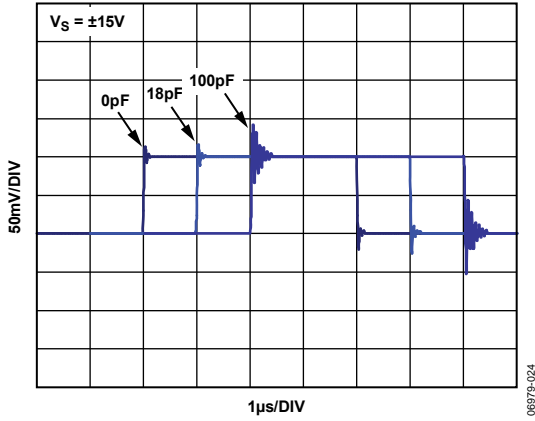

Figure 22. Small Signal Step Response, Gain = 0.5

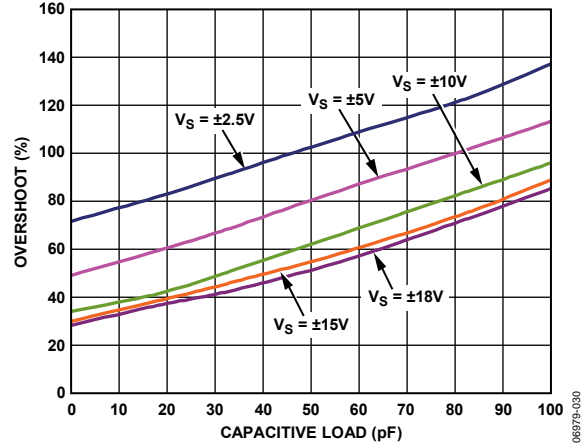

Figure 25. Small Signal Overshoot with Capacitive Load, Gain = 0.5

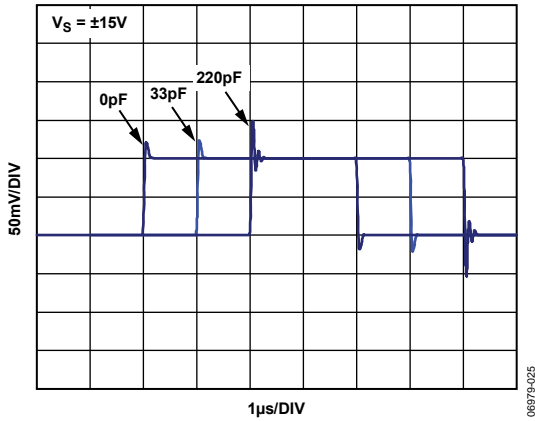

Figure 23. Small Signal Step Response, Gain = 1

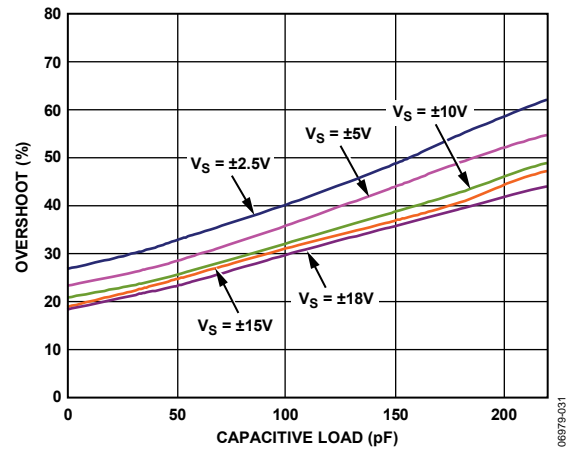

Figure 26. Small Signal Overshoot with Capacitive Load, Gain = 1

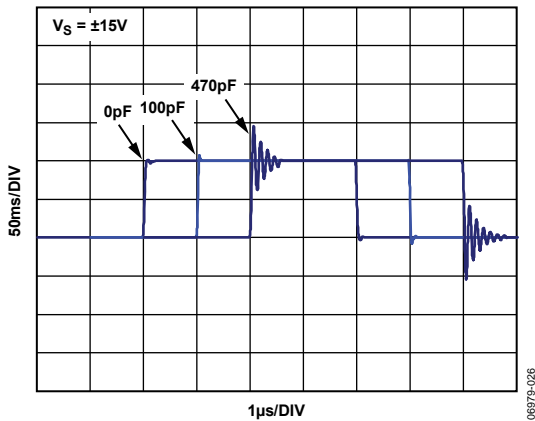

Figure 24. Small Signal Step Response, Gain = 2

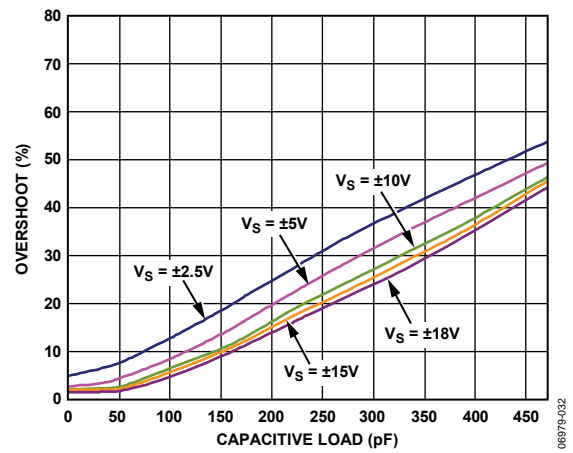

Figure 27. Small Signal Overshoot with Capacitive Load, Gain = 2

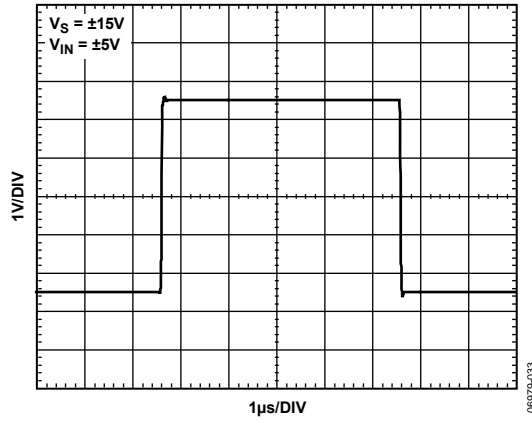

Figure 28. Large Signal Pulse Response Gain = 0.5

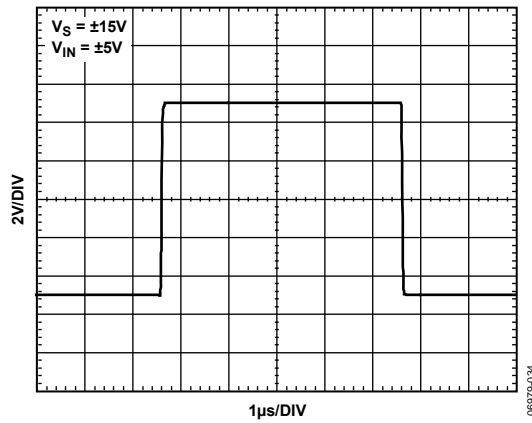

Figure 29. Large Signal Pulse Response Gain = 1

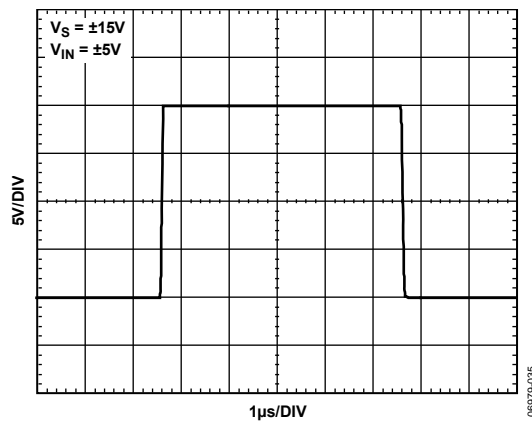

Figure 30. Large Signal Pulse Response, Gain = 2

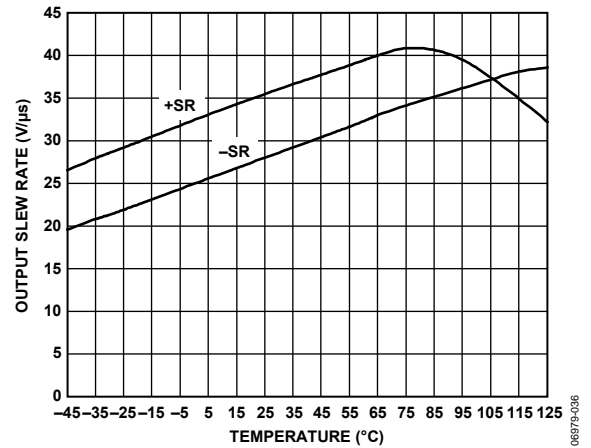

Figure 31. Output Slew Rate vs. Temperature

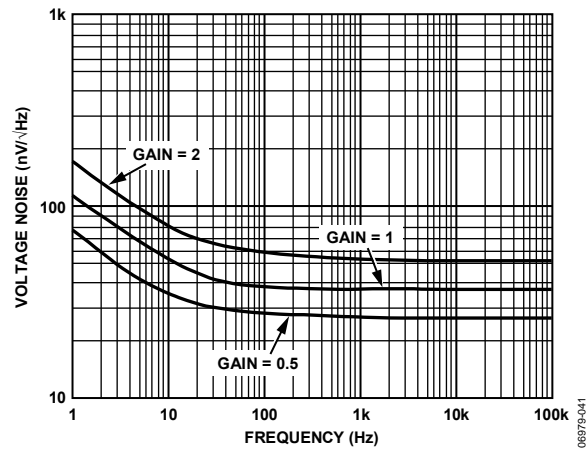

Figure 32. Voltage Noise Spectral Density vs. Frequency, Referred to Output

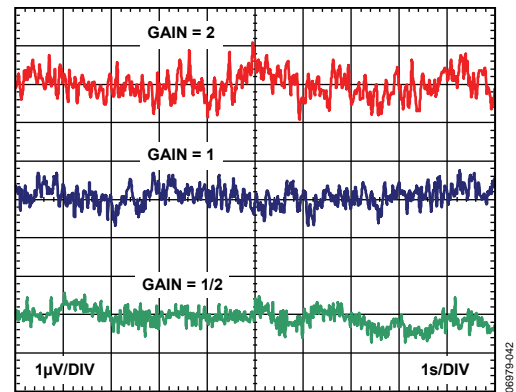

Figure 33. 0.1 Hz to 10 Hz Voltage Noise, Referred to Output

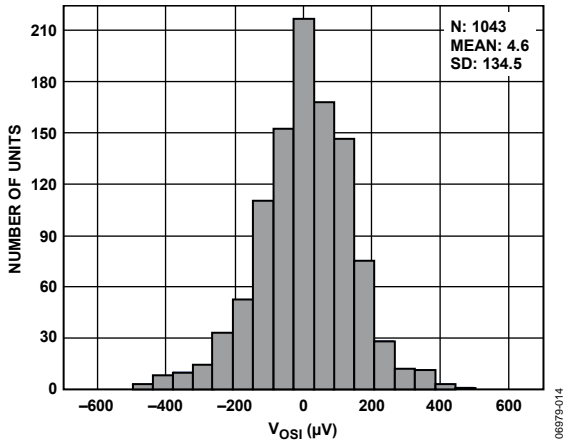

Figure 34. Typical Distribution of Op Amp Voltage Offset

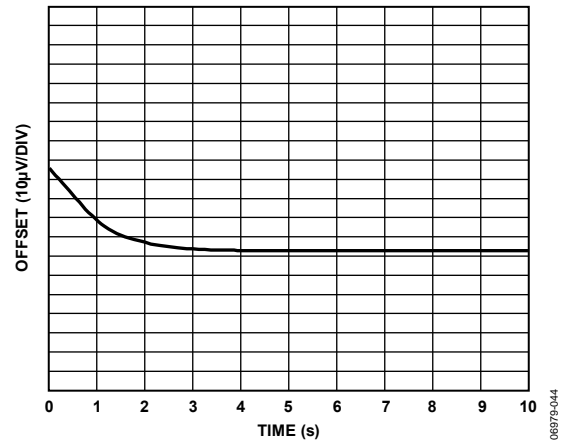

Figure 37. Change in Op Amp Offset Voltage vs. Warm-Up Time

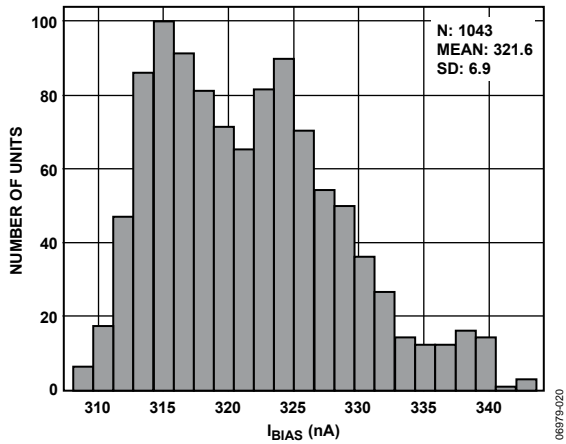

Figure 35. Typical Distribution of Op Amp Bias Current

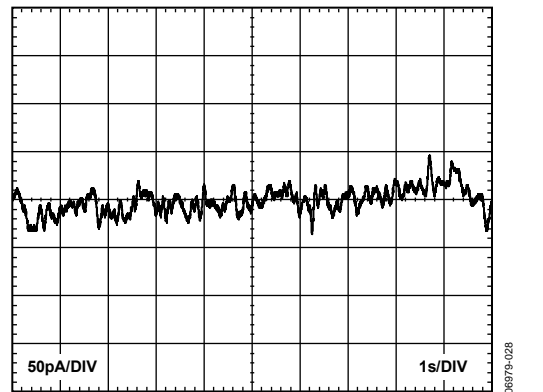

Figure 38. 0.1 Hz to 10 Hz Current Noise of Internal Op Amp

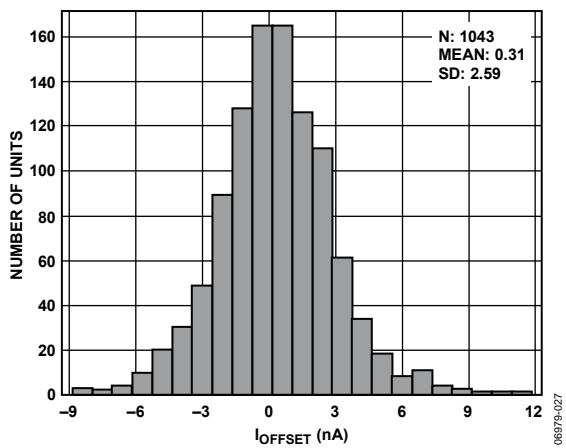

Figure 36. Typical Distribution of Op Amp Offset Current

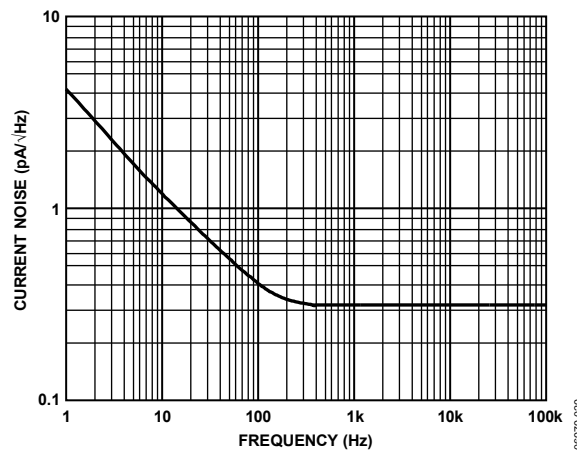

Figure 39. Current Noise Spectral Density of Internal Op Amp

THEORY OF OPERATION

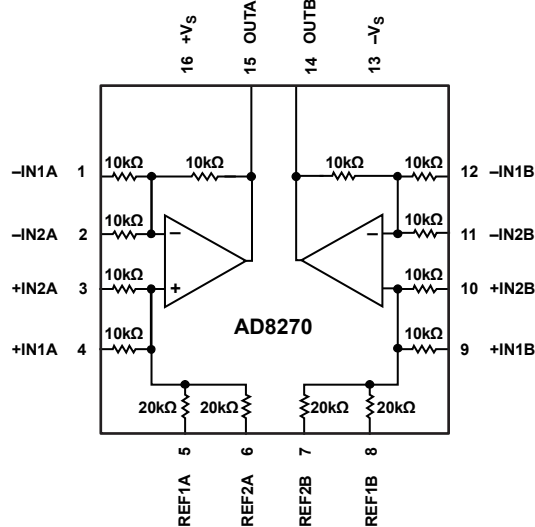

Figure 40. Functional Block Diagram

CIRCUIT INFORMATION

The AD8270 has two channels, each consisting of a high precision, low distortion op amp and seven trimmed resistors. These resistors can be connected to make a wide variety of amplifier configurations: difference, noninverting, inverting, and more. The resistors on the chip can be connected in parallel for a wider range of options. Using the on-chip resistors of the AD8270 provides the designer several advantages over a discrete design.

DC Performance

Much of the dc performance of op amp circuits depends on the accuracy of the surrounding resistors. The resistors on the AD8270 are laid out to be tightly matched. The resistors of each device are laser trimmed and tested for their matching accuracy. Because of this trimming and testing, the AD8270 can guarantee high accuracy for specifications such as gain drift, common-mode rejection, and gain error.

AC Performance

Because feature size is much smaller in an integrated circuit than on a printed circuit board (PCB), the corresponding parasitics are smaller, as well. The smaller feature size helps the ac performance of the AD8270. For example, the positive and negative input terminals of the AD8270 op amp are not pinned out intentionally. By not connecting these nodes to the traces on the PCB, the capacitance remains low, resulting in both improved loop stability and common-mode rejection over frequency.

Production Costs

Because one part, rather than several, is placed on the PCB, the board can be built more quickly.

Size

The AD8270 fits two op amps and 14 resistors in a 4 mm × 4 mm package.

DRIVING THE AD8270

The AD8270 is easy to drive, with all configurations presenting at least several kilohms (kΩ) of input resistance. The AD8270 should be driven with a low impedance source: for example, another amplifier. The gain accuracy and common-mode rejection of the AD8270 depend on the matching of its resistors. Even source resistance of a few ohms can have a substantial effect on these specifications.

PACKAGE CONSIDERATIONS

The AD8270 is packaged in a 4 mm × 4 mm LFCSP. Beware of blindly copying the footprint from another 4 mm × 4 mm LFCSP device; it may not have the same thermal pad size and leads. Refer to the Outline Dimensions section to verify that the PCB symbol has the correct dimensions.

The 4 mm × 4 mm LFCSP of the AD8270 comes with a thermal pad. This pad is connected internally to $-V_s$. Connecting to this pad is not necessary for electrical performance; the pad can be left unconnected or can be connected to the negative supply rail.

Connecting the pad to the negative supply rail is recommended in high vibration applications or when good heat dissipation is required (for example, with high ambient temperatures or when driving heavy loads). For best heat dissipation performance, the negative supply rail should be a plane in the board. See the Absolute Maximum Ratings section for thermal coefficients with and without the pad soldered.

Space between the leads and thermal pad should be as wide as possible to minimize the risk of contaminants affecting performance. A thorough washing of the board is recommended after the soldering process, especially if high accuracy performance is required at high temperatures.

POWER SUPPLIES

A stable dc voltage should be used to power the AD8270. Noise on the supply pins can adversely affect performance. A bypass capacitor of 0.1 μF should be placed between each supply pin and ground, as close as possible to each supply pin. A tantalum capacitor of 10 μF should also be used between each supply and ground. It can be farther away from the supply pins and, typically, it can be shared by other precision integrated circuits.

The AD8270 is specified at ±15 V and ±5 V, but it can be used with unbalanced supplies, as well. For example, $-V_s = 0$ V, $+V_s = 20$ V. The difference between the two supplies must be kept below 36 V.

INPUT VOLTAGE RANGE

The AD8270 has a true rail-to-rail input range for the majority of applications. Because most AD8270 configurations divide down the voltage before they reach the internal op amp, the op amp sees only a fraction of the input voltage. Figure 41 shows an example of how the voltage division works in the difference amplifier configuration.

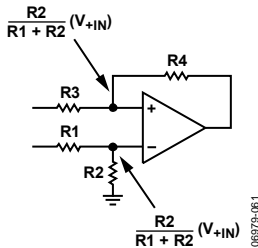

Figure 41. Voltage Division in the Difference Amplifier Configuration

The internal op amp voltage range may be relevant in the following applications, and calculating the voltage at the internal op amp is advised.

- Difference amplifier configurations using supply voltages of less than ± 4.5 V
- Difference amplifier configurations with a reference voltage near the rail
- Single-ended amplifier configurations

For correct operation, the input voltages at the internal op amp must stay within 1.5 V of either supply rail.

Voltages beyond the supply rails should not be applied to the device. The device contains ESD diodes at the input pins, which conduct if voltages beyond the rails are applied. Currents greater than 5 mA can damage these diodes and the device. For a similar device that can operate with voltages beyond the rails, see the AD8273 data sheet.

APPLICATIONS INFORMATION

DIFFERENCE AMPLIFIER CONFIGURATIONS

The AD8270 can be placed in difference amplifier configurations with gains of 0.5, 1, and 2. Figure 42 through Figure 44 show the difference amplifier configurations, referenced to ground. The AD8270 can also be referred to a combination of reference voltages. For example, the reference could be set at 2.5 V, using just 5 V and GND. Some of the possible configurations are shown in Figure 45 through Figure 47.

The layout for Channel A is shown in Figure 42 through Figure 47. The layout for Channel B is symmetrical. Table 7 shows the pin connections for Channel A and Channel B.

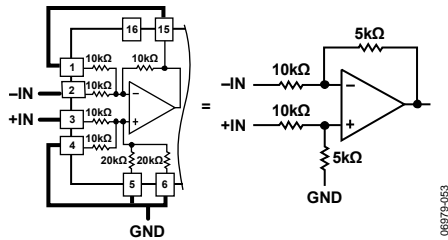

Figure 42. Gain = 0.5 Difference Amplifier, Referenced to Ground

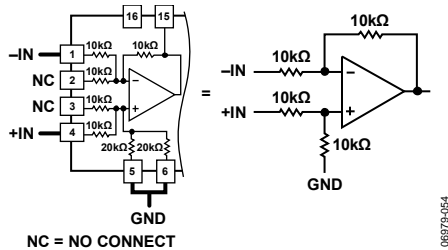

Figure 43. Gain = 1 Difference Amplifier, Referenced to Ground

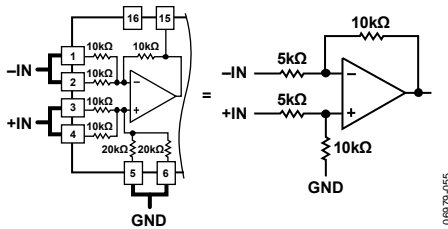

Figure 44. Gain = 2 Difference Amplifier, Referenced to Ground

SINGLE-ENDED CONFIGURATIONS

The AD8270 can be configured for a wide variety of single-ended configurations with gains ranging from -2 to +3. Table 8 shows a subset of the possible configurations.

Many signal gains have more than one configuration choice, which allows freedom in choosing the op amp closed-loop gain. In general, for designs that need to be stable with a large capacitive load on the output, choose a configuration with high loop gain. Otherwise, choose a configuration with low loop gain, because these configurations typically have lower noise, lower offset, and higher bandwidth.

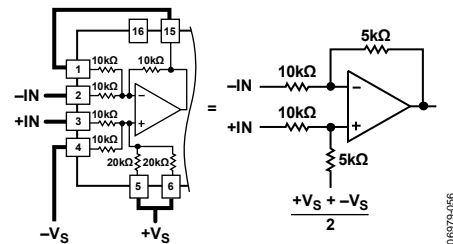

Figure 45. Gain = 0.5 Difference Amplifier, Referenced to Midsupply

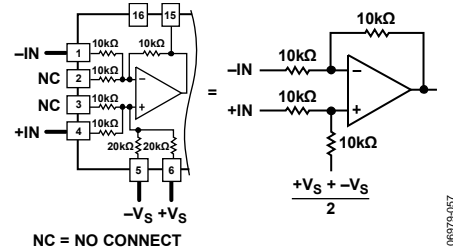

Figure 46. Gain = 1 Difference Amplifier, Referenced to Midsupply

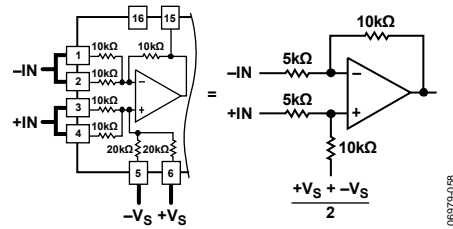

Figure 47. Gain = 2 Difference Amplifier, Referenced to Midsupply

Table 7. Pin Connections for Difference Amplifier Configurations

| Gain and Reference | Channel A | | | | | | Channel B | | | | | |
|--------------------------------------|-----------|-------|-------|-------|-------|-------|-----------|--------|--------|-------|-------|-------|
| | Pin 1 | Pin 2 | Pin 3 | Pin 4 | Pin 5 | Pin 6 | Pin 12 | Pin 11 | Pin 10 | Pin 9 | Pin 8 | Pin 7 |
| Gain of 0.5, Referenced to Ground | OUT | -IN | +IN | GND | GND | GND | OUT | -IN | +IN | GND | GND | GND |
| Gain of 0.5, Referenced to Midsupply | OUT | -IN | +IN | -Vs | +Vs | +Vs | OUT | -IN | +IN | -Vs | +Vs | +Vs |
| Gain of 1, Referenced to Ground | -IN | NC | NC | +IN | GND | GND | -IN | NC | NC | +IN | GND | GND |
| Gain of 1, Referenced to Midsupply | -IN | NC | NC | +IN | -Vs | +Vs | -IN | NC | NC | +IN | -Vs | +Vs |
| Gain of 2, Referenced to Ground | -IN | -IN | +IN | +IN | GND | GND | -IN | -IN | +IN | +IN | GND | GND |
| Gain of 2, Referenced to Midsupply | -IN | -IN | +IN | +IN | -Vs | +Vs | -IN | -IN | +IN | +IN | -Vs | +Vs |

Table 8. Selected Single-Ended Configurations

| Electrical Performance | | | Pin Connections | | | | | |
|------------------------|-------------------------|------------------|-----------------------|-----------------------|-----------------------|-----------------------|-----------------------|-----------------------|
| Signal Gain | Op Amp Closed-Loop Gain | Input Resistance | 10 k Ω – Pin 1 | 10 k Ω – Pin 2 | 10 k Ω + Pin 3 | 10 k Ω + Pin 4 | 20 k Ω + Pin 5 | 20 k Ω + Pin 6 |
| -2 | 3 | 5 k Ω | IN | IN | GND | GND | GND | GND |
| -1.5 | 3 | 4.8 k Ω | IN | IN | GND | GND | GND | IN |
| -1.4 | 3 | 5 k Ω | IN | IN | GND | GND | NC | IN |
| -1.25 | 3 | 5.333 k Ω | IN | IN | GND | NC | GND | IN |
| -1 | 3 | 5 k Ω | IN | IN | GND | GND | IN | IN |
| -0.8 | 3 | 5.556 k Ω | IN | IN | IN | GND | NC | GND |
| -0.667 | 2 | 8 k Ω | IN | NC | GND | GND | GND | IN |
| -0.6 | 2 | 8.333 k Ω | IN | NC | GND | GND | NC | IN |
| -0.5 | 2 | 8.889 k Ω | IN | NC | GND | NC | GND | IN |
| -0.333 | 2 | 7.5 k Ω | IN | NC | GND | GND | IN | IN |
| -0.25 | 1.5 | 8 k Ω | OUT | IN | GND | GND | GND | IN |
| -0.2 | 1.5 | 8.333 k Ω | OUT | IN | GND | GND | NC | IN |
| -0.125 | 1.5 | 8.889 k Ω | OUT | IN | GND | NC | GND | IN |
| +0.1 | 1.5 | 8.333 k Ω | OUT | IN | IN | GND | NC | GND |
| +0.2 | 2 | 10 k Ω | IN | NC | GND | IN | NC | IN |
| +0.25 | 1.5 | 24 k Ω | OUT | GND | GND | GND | GND | IN |
| +0.3 | 1.5 | 25 k Ω | OUT | GND | GND | GND | NC | IN |
| +0.333 | 2 | 24 k Ω | GND | NC | GND | GND | GND | IN |
| +0.375 | 1.5 | 26.67 k Ω | OUT | GND | GND | NC | GND | IN |
| +0.4 | 2 | 25 k Ω | GND | NC | GND | GND | NC | IN |
| +0.5 | 3 | 24 k Ω | GND | GND | GND | GND | GND | IN |
| +0.5 | 1.5 | 15 k Ω | OUT | GND | GND | GND | IN | IN |
| +0.6 | 3 | 25 k Ω | GND | GND | GND | GND | NC | IN |
| +0.6 | 1.5 | 16.67 k Ω | OUT | GND | IN | GND | NC | GND |
| +0.625 | 1.5 | 16 k Ω | OUT | IN | NC | IN | IN | GND |
| +0.667 | 2 | 15 k Ω | GND | NC | GND | GND | IN | IN |
| +0.7 | 1.5 | 16.67 k Ω | OUT | IN | IN | IN | NC | GND |
| +0.75 | 3 | 26.67 k Ω | GND | GND | GND | NC | GND | IN |
| +0.75 | 1.5 | 13.33 k Ω | OUT | GND | GND | IN | GND | IN |
| +0.8 | 2 | 16.67 k Ω | GND | NC | IN | GND | NC | GND |
| +0.9 | 1.5 | 16.67 k Ω | OUT | GND | GND | IN | NC | IN |
| +1 | 1.5 | 15 k Ω | OUT | GND | IN | IN | GND | GND |
| +1 | 1.5 | >1 G Ω | OUT | IN | IN | IN | IN | IN |
| +1 | 3 | >1 G Ω | IN | IN | IN | IN | IN | IN |
| +1.125 | 1.5 | 26.67 k Ω | OUT | GND | NC | IN | IN | GND |
| +1.2 | 3 | 16.67 k Ω | GND | GND | IN | GND | NC | GND |
| +1.2 | 1.5 | 25 k Ω | OUT | GND | IN | IN | NC | GND |
| +1.25 | 1.5 | 24 k Ω | OUT | GND | IN | IN | IN | GND |
| +1.333 | 2 | 15 k Ω | GND | NC | IN | IN | GND | GND |
| +1.5 | 3 | 13.33 k Ω | GND | GND | GND | IN | GND | IN |
| +1.5 | 1.5 | >1 G Ω | OUT | GND | IN | IN | IN | IN |
| +1.6 | 2 | 25 k Ω | GND | NC | IN | IN | NC | GND |
| +1.667 | 2 | 24 k Ω | GND | NC | IN | IN | IN | GND |
| +1.8 | 3 | 16.67 k Ω | GND | GND | GND | IN | NC | IN |
| +2 | 2 | >1 G Ω | GND | NC | IN | IN | IN | IN |
| +2.25 | 3 | 26.67 k Ω | GND | GND | NC | IN | IN | GND |
| +2.4 | 3 | 25 k Ω | GND | GND | IN | IN | NC | GND |
| +2.5 | 3 | 24 k Ω | GND | GND | IN | IN | IN | GND |
| +3 | 3 | >1 G Ω | GND | GND | IN | IN | IN | IN |

The AD8270 Specifications section and Typical Performance Characteristics section show the performance of the device primarily when it is in the difference amplifier configuration. To get a good estimate of the performance of the device in a single-ended configuration, refer to the difference amplifier configuration with the corresponding closed-loop gain (see Table 9).

Table 9. Closed-Loop Gain of the Difference Amplifiers

| Difference Amplifier Gain | Closed-Loop Gain |
|---------------------------|------------------|
| 0.5 | 1.5 |
| 1 | 2 |
| 2 | 3 |

Gain of 1 Configuration

The AD8270 is designed to be stable for loop gains of 1.5 and greater. Because a typical voltage follower configuration has a loop gain of 1, it may be unstable. Several stable G = 1 configurations are listed in Table 8.

DIFFERENTIAL OUTPUT

The AD8270 can easily be configured for differential output. Figure 48 shows the configuration for a G = 1 differential output amplifier. The OCM node in the figure sets the common-mode output voltage. Figure 49 shows the configuration for a G = 1 differential output amplifier, where the average of two voltages sets the common-mode output voltage. For example, this configuration can be used to set the common mode at 2.5 V, using just a 5 V reference and GND.

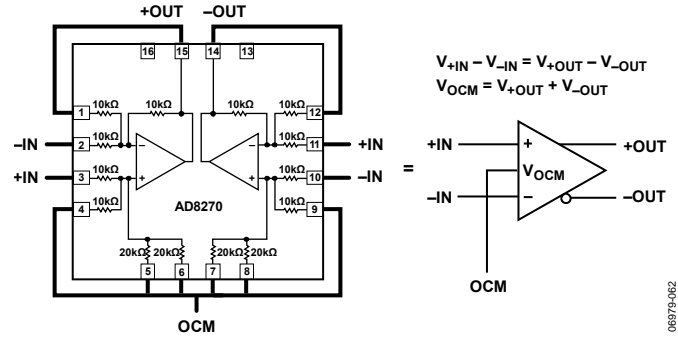

Figure 48. Differential Output, G = 1, Common-Mode Output Voltage Set with Reference Voltage

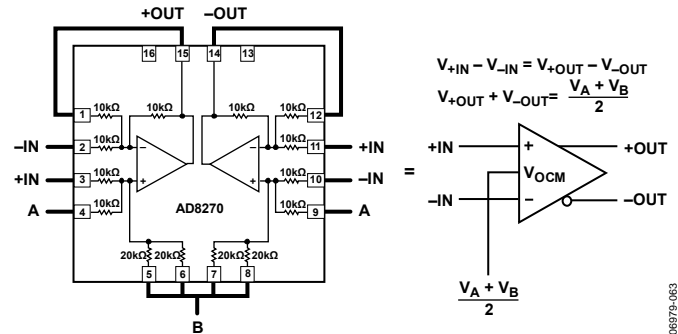

Figure 49. Differential Output, G = 1, Common-Mode Output Voltage Set as the Average of Two Voltages

Note that these two configurations are based on the G = 0.5 difference amplifier configurations shown in Figure 42 and Figure 45. A similar technique can be used to create differential output with a gain of 2 or 4, using the G = 1 and G = 2 difference amplifier configurations, respectively.

DRIVING AN ADC

The high slew rate and drive capability of the AD8270, combined with its dc accuracy, make it a good analog-to-digital converter (ADC) driver. The AD8270 can drive both single-ended and differential input ADCs. Many converters require the output to be buffered with a small value resistor combined with a high quality ceramic capacitor. See the converter data sheet for more details. Figure 51 shows the AD8270 in differential configuration, driving the AD7688 ADC. The AD8270 divides down the 5 V reference voltage from the ADR435, so that the common-mode output voltage is 2.5 V, which is precisely where the AD7688 needs it.

DRIVING CABLING

All cables have a certain capacitance per unit length, which varies widely with cable type. The capacitive load from the cable may cause peaking or instability in output response, especially when the AD8270 is operating in a gain of 0.5.

To reduce the peaking, use a resistor between the AD8270 and the cable. Because cable capacitance and desired output response vary widely, this resistor is best determined empirically. A good starting point is 20 Ω.

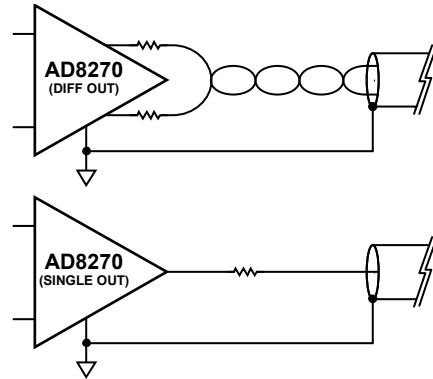

Figure 50. Driving Cabling

06879-060

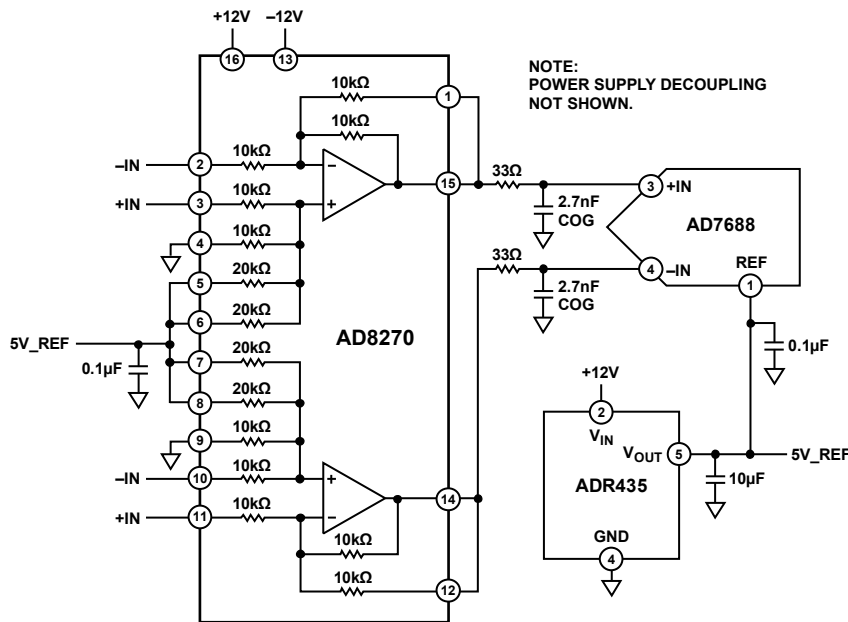

Figure 51. Driving an ADC

06879-037

NOTES

Mouser Electronics

Authorized Distributor

Click to View Pricing, Inventory, Delivery & Lifecycle Information:

[Analog Devices Inc.:](#)

[AD8270ACPZ-R7](#) [AD8270ACPZ-RL](#) [AD8270ACPZ-WP](#)