

FEATURES

High Dynamic Range

Output IP3: +28 dBm: Re 50 Ω @ 250 MHz

Low Noise Figure: 5.9 dB @ 250 MHz

Two Gain Versions:

AD8350-15: 15 dB

AD8350-20: 20 dB

-3 dB Bandwidth: 1.0 GHz

Single Supply Operation: 5 V to 10 V

Supply Current: 28 mA

Input/Output Impedance: 200 Ω

Single-Ended or Differential Input Drive

8-Lead SOIC Package and 8-Lead microSOIC Package

APPLICATIONS

Cellular Base Stations

Communications Receivers

RF/IF Gain Block

Differential A-to-D Driver

SAW Filter Interface

Single-Ended-to-Differential Conversion

High Performance Video

High Speed Data Transmission

PRODUCT DESCRIPTION

The AD8350 series are high performance fully-differential amplifiers useful in RF and IF circuits up to 1000 MHz. The amplifier has excellent noise figure of 5.9 dB at 250 MHz. It offers a high output third order intercept (OIP3) of +28 dBm at 250 MHz. Gain versions of 15 dB and 20 dB are offered.

The AD8350 is designed to meet the demanding performance requirements of communications transceiver applications. It enables a high dynamic range differential signal chain, with exceptional linearity and increased common-mode rejection. The device can be used as a general purpose gain block, an A-to-D driver, and high speed data interface driver, among other functions. The AD8350 input can also be used as a single-ended-to-differential converter.

FUNCTIONAL BLOCK DIAGRAM

8-Lead SOIC and μ SOIC Packages (with Enable)

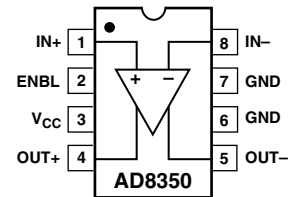

The amplifier can be operated down to 5 V with an OIP3 of +28 dBm at 250 MHz and slightly reduced distortion performance. The wide bandwidth, high dynamic range and temperature stability make this product ideal for the various RF and IF frequencies required in cellular, CATV, broadband, instrumentation and other applications.

The AD8350 is offered in an 8-lead single SOIC package and μ SOIC package. It operates from 5 V and 10 V power supplies, drawing 28 mA typical. The AD8350 offers a power enable function for power-sensitive applications. The AD8350 is fabricated using Analog Devices' proprietary high speed complementary bipolar process. The device is available in the industrial (-40°C to +85°C) temperature range.

REV. B

Information furnished by Analog Devices is believed to be accurate and reliable. However, no responsibility is assumed by Analog Devices for its use, nor for any infringements of patents or other rights of third parties that may result from its use. No license is granted by implication or otherwise under any patent or patent rights of Analog Devices.

AD8350—SPECIFICATIONS (@ 25°C, V_S = 5 V, G = 15 dB, unless otherwise noted. All specifications refer to differential inputs and differential outputs unless noted.)

Parameter	Conditions	Min	Typ	Max	Unit
DYNAMIC PERFORMANCE					
-3 dB Bandwidth	V _S = 5 V, V _{OUT} = 1 V p-p		0.9		GHz
	V _S = 10 V, V _{OUT} = 1 V p-p		1.1		GHz
Bandwidth for 0.1 dB Flatness	V _S = 5 V, V _{OUT} = 1 V p-p		90		MHz
	V _S = 10 V, V _{OUT} = 1 V p-p		90		MHz
Slew Rate	V _{OUT} = 1 V p-p		2000		V/μs
Settling Time	0.1%, V _{OUT} = 1 V p-p		10		ns
Gain (S ₂₁) ¹	V _S = 5 V, f = 50 MHz	14	15	16	dB
Gain Supply Sensitivity	V _S = 5 V to 10 V, f = 50 MHz		0.003		dB/V
Gain Temperature Sensitivity	T _{MIN} to T _{MAX}		-0.002		dB/°C
Isolation (S ₁₂) ¹	f = 50 MHz		-18		dB
NOISE/HARMONIC PERFORMANCE					
50 MHz Signal					
Second Harmonic	V _S = 5 V, V _{OUT} = 1 V p-p		-66		dBc
	V _S = 10 V, V _{OUT} = 1 V p-p		-67		dBc
Third Harmonic	V _S = 5 V, V _{OUT} = 1 V p-p		-65		dBc
	V _S = 10 V, V _{OUT} = 1 V p-p		-70		dBc
Output Second Order Intercept ²	V _S = 5 V		58		dBm
	V _S = 10 V		58		dBm
Output Third Order Intercept ²	V _S = 5 V		28		dBm
	V _S = 10 V		29		dBm
250 MHz Signal					
Second Harmonic	V _S = 5 V, V _{OUT} = 1 V p-p		-48		dBc
	V _S = 10 V, V _{OUT} = 1 V p-p		-49		dBc
Third Harmonic	V _S = 5 V, V _{OUT} = 1 V p-p		-52		dBc
	V _S = 10 V, V _{OUT} = 1 V p-p		-61		dBc
Output Second Order Intercept ²	V _S = 5 V		39		dBm
	V _S = 10 V		40		dBm
Output Third Order Intercept ²	V _S = 5 V		24		dBm
	V _S = 10 V		28		dBm
1 dB Compression Point (RTI) ²	V _S = 5 V		2		dBm
	V _S = 10 V		5		dBm
Voltage Noise (RTI)	f = 150 MHz		1.7		nV/√Hz
Noise Figure	f = 150 MHz		6.8		dB
INPUT/OUTPUT CHARACTERISTICS					
Differential Offset Voltage (RTI)	V _{OUT+} - V _{OUT-}		±1		mV
Differential Offset Drift	T _{MIN} to T _{MAX}		0.02		mV/°C
Input Bias Current			15		μA
Input Resistance	Real		200		Ω
CMRR	f = 50 MHz		-67		dB
Output Resistance	Real		200		Ω
POWER SUPPLY					
Operating Range		4		11.0	V
Quiescent Current	Powered Up, V _S = 5 V	25	28	32	mA
	Powered Down, V _S = 5 V	3	3.8	5.5	mA
	Powered Up, V _S = 10 V	27	30	34	mA
	Powered Down, V _S = 10 V	3	4	6.5	mA
Power-Up/Down Switching			15		ns
Power Supply Rejection Ratio	f = 50 MHz, V _S Δ = 1 V p-p		-58		dB
OPERATING TEMPERATURE RANGE					
		-40		+85	°C

NOTES

¹See Tables II-III for complete list of S-Parameters.

²Re: 50 Ω.

Specifications subject to change without notice.

AD8350-20—SPECIFICATIONS

(@ 25°C, $V_S = 5\text{ V}$, $G = 20\text{ dB}$, unless otherwise noted. All specifications refer to differential inputs and differential outputs unless noted.)

Parameter	Conditions	Min	Typ	Max	Unit
DYNAMIC PERFORMANCE					
-3 dB Bandwidth	$V_S = 5\text{ V}$, $V_{OUT} = 1\text{ V p-p}$		0.7		GHz
	$V_S = 10\text{ V}$, $V_{OUT} = 1\text{ V p-p}$		0.9		GHz
Bandwidth for 0.1 dB Flatness	$V_S = 5\text{ V}$, $V_{OUT} = 1\text{ V p-p}$		90		MHz
	$V_S = 10\text{ V}$, $V_{OUT} = 1\text{ V p-p}$		90		MHz
Slew Rate	$V_{OUT} = 1\text{ V p-p}$		2000		V/ μs
Settling Time	0.1%, $V_{OUT} = 1\text{ V p-p}$		15		ns
Gain (S21) ¹	$V_S = 5\text{ V}$, $f = 50\text{ MHz}$	19	20	21	dB
Gain Supply Sensitivity	$V_S = 5\text{ V to }10\text{ V}$, $f = 50\text{ MHz}$		0.003		dB/V
Gain Temperature Sensitivity	T_{MIN} to T_{MAX}		-0.002		dB/°C
Isolation (S12) ¹	$f = 50\text{ MHz}$		-22		dB
NOISE/HARMONIC PERFORMANCE					
50 MHz Signal					
Second Harmonic	$V_S = 5\text{ V}$, $V_{OUT} = 1\text{ V p-p}$		-65		dBc
	$V_S = 10\text{ V}$, $V_{OUT} = 1\text{ V p-p}$		-66		dBc
Third Harmonic	$V_S = 5\text{ V}$, $V_{OUT} = 1\text{ V p-p}$		-66		dBc
	$V_S = 10\text{ V}$, $V_{OUT} = 1\text{ V p-p}$		-70		dBc
Output Second Order Intercept ²	$V_S = 5\text{ V}$		56		dBm
	$V_S = 10\text{ V}$		56		dBm
Output Third Order Intercept ²	$V_S = 5\text{ V}$		28		dBm
	$V_S = 10\text{ V}$		29		dBm
250 MHz Signal					
Second Harmonic	$V_S = 5\text{ V}$, $V_{OUT} = 1\text{ V p-p}$		-45		dBc
	$V_S = 10\text{ V}$, $V_{OUT} = 1\text{ V p-p}$		-46		dBc
Third Harmonic	$V_S = 5\text{ V}$, $V_{OUT} = 1\text{ V p-p}$		-55		dBc
	$V_S = 10\text{ V}$, $V_{OUT} = 1\text{ V p-p}$		-60		dBc
Output Second Order Intercept ²	$V_S = 5\text{ V}$		37		dBm
	$V_S = 10\text{ V}$		38		dBm
Output Third Order Intercept ²	$V_S = 5\text{ V}$		24		dBm
	$V_S = 10\text{ V}$		28		dBm
1 dB Compression Point (RTI) ²	$V_S = 5\text{ V}$		-2.6		dBm
	$V_S = 10\text{ V}$		1.8		dBm
Voltage Noise (RTI)	$f = 150\text{ MHz}$		1.7		nV/ $\sqrt{\text{Hz}}$
Noise Figure	$f = 150\text{ MHz}$		5.6		dB
INPUT/OUTPUT CHARACTERISTICS					
Differential Offset Voltage (RTI)	$V_{OUT+} - V_{OUT-}$		± 1		mV
Differential Offset Drift	T_{MIN} to T_{MAX}		0.02		mV/°C
Input Bias Current			15		μA
Input Resistance	Real		200		Ω
CMRR	$f = 50\text{ MHz}$		-52		dB
Output Resistance	Real		200		Ω
POWER SUPPLY					
Operating Range		4		11.0	V
Quiescent Current	Powered Up, $V_S = 5\text{ V}$	25	28	32	mA
	Powered Down, $V_S = 5\text{ V}$	3	3.8	5.5	mA
	Powered Up, $V_S = 10\text{ V}$	27	30	34	mA
	Powered Down, $V_S = 10\text{ V}$	3	4	6.5	mA
Power-Up/Down Switching			15		ns
Power Supply Rejection Ratio	$f = 50\text{ MHz}$, $V_S \Delta = 1\text{ V p-p}$		-45		dB
OPERATING TEMPERATURE RANGE					
		-40		+85	°C

NOTES

¹See Tables II-III for complete list of S-Parameters.²Re: 50 Ω .

AD8350

ABSOLUTE MAXIMUM RATINGS*

Supply Voltage, V_S	11 V
Input Power Differential	+8 dBm
Internal Power Dissipation	400 mW
θ_{JA} SOIC (R)	100°C/W
θ_{JA} μ SOIC (RM)	133°C/W
Maximum Junction Temperature	125°C
Operating Temperature Range	-40°C to +85°C
Storage Temperature Range	-65°C to +150°C
Lead Temperature Range (Soldering 60 sec)	300°C

*Stresses above those listed under Absolute Maximum Ratings may cause permanent damage to the device. This is a stress rating only; functional operation of the device at these or any other conditions above those indicated in the operational section of this specification is not implied. Exposure to absolute maximum rating conditions for extended periods may affect device reliability.

PIN CONFIGURATION

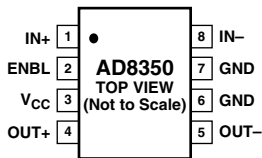

PIN FUNCTION DESCRIPTIONS

Pin	Function	Description
1, 8	IN+, IN-	Differential Inputs. IN+ and IN- should be ac-coupled (pins have a dc bias of midsupply). Differential input impedance is 200 Ω .
2	ENBL	Power-up Pin. A high level (5 V) enables the device; a low level (0 V) puts device in sleep mode.
3	V_{CC}	Positive Supply Voltage. 5 V to 10 V.
4, 5	OUT+, OUT-	Differential Outputs. OUT+ and OUT- should be ac-coupled (pins have a dc bias of midsupply). Differential input impedance is 200 Ω .
6, 7	GND	Common External Ground Reference.

CAUTION

ESD (electrostatic discharge) sensitive device. Electrostatic charges as high as 4000 V readily accumulate on the human body and test equipment and can discharge without detection. Although the AD8350 features proprietary ESD protection circuitry, permanent damage may occur on devices subjected to high-energy electrostatic discharges. Therefore, proper ESD precautions are recommended to avoid performance degradation or loss of functionality.



Typical Performance Characteristics—AD8350

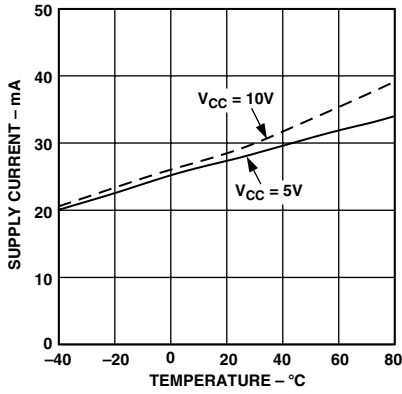

TPC 1. Supply Current vs. Temperature

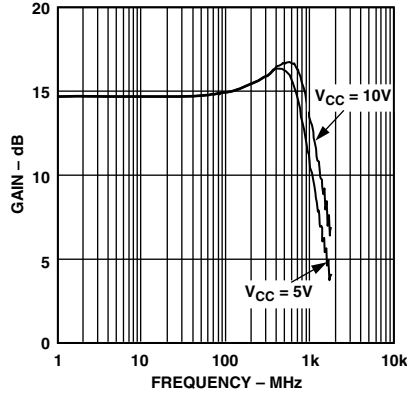

TPC 2. AD8350-15 Gain (S21) vs. Frequency

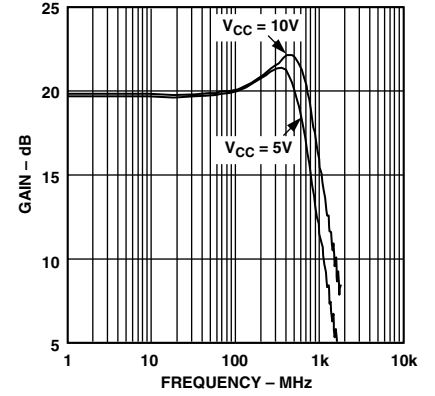

TPC 3. AD8350-20 Gain (S21) vs. Frequency

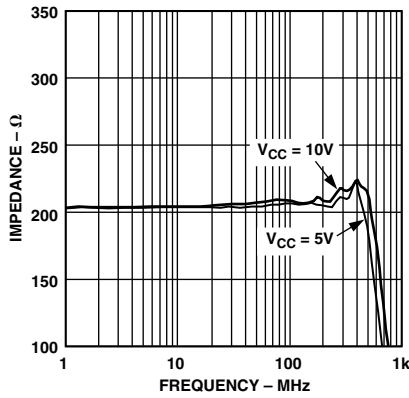

TPC 4. AD8350-15 Input Impedance vs. Frequency

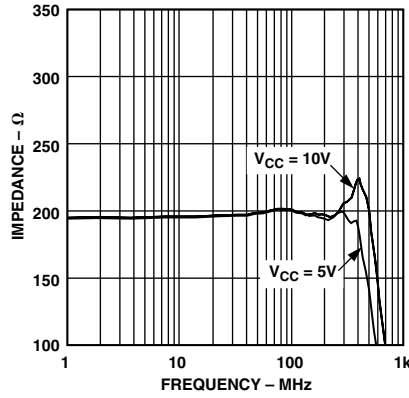

TPC 5. AD8350-20 Input Impedance vs. Frequency

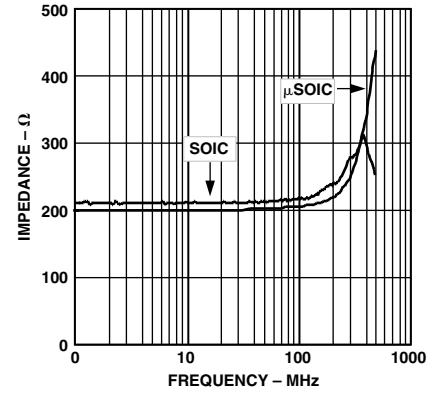

TPC 6. AD8350-15 Output Impedance vs. Frequency

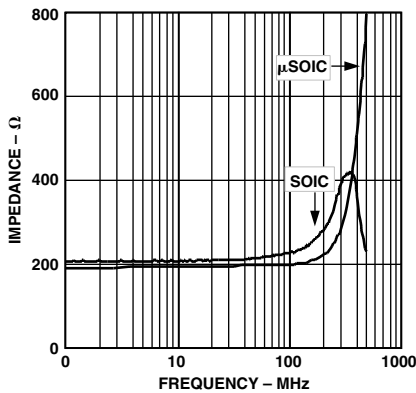

TPC 7. AD8350-20 Output Impedance vs. Frequency

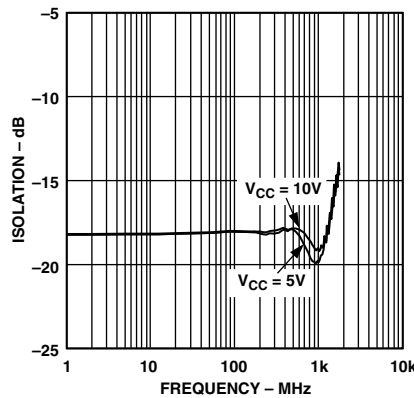

TPC 8. AD8350-15 Isolation (S12) vs. Frequency

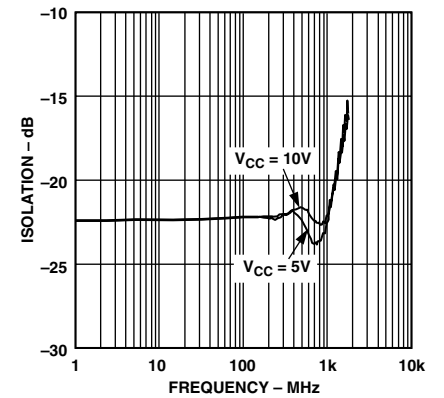

TPC 9. AD8350-20 Isolation (S12) vs. Frequency

AD8350

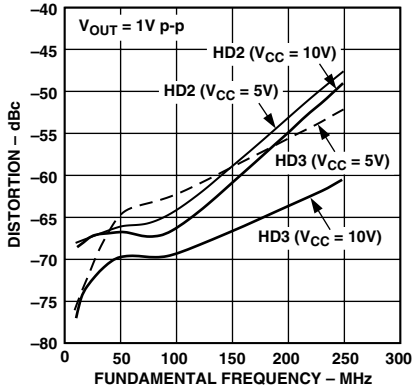

TPC 10. AD8350-15 Harmonic Distortion vs. Frequency

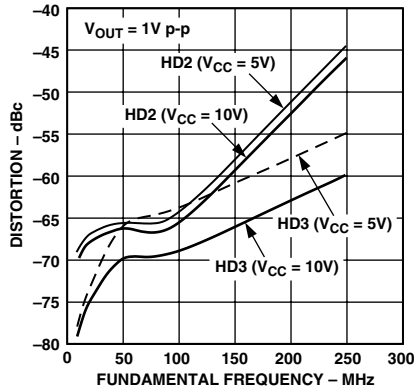

TPC 11. AD8350-20 Harmonic Distortion vs. Frequency

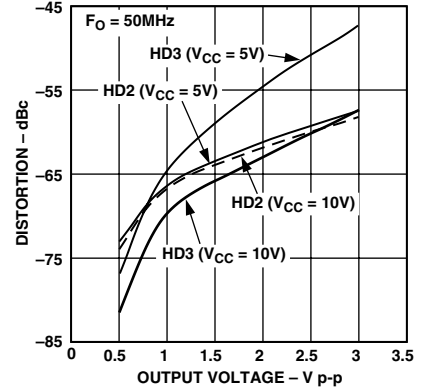

TPC 12. AD8350-15 Harmonic Distortion vs. Differential Output Voltage

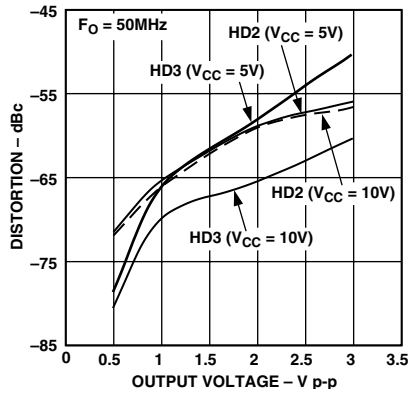

TPC 13. AD8350-20 Harmonic Distortion vs. Differential Output Voltage

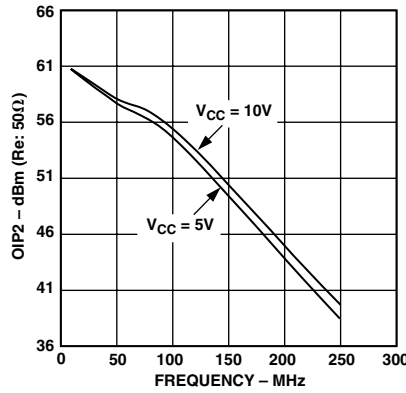

TPC 14. AD8350-15 Output Referred IP2 vs. Frequency

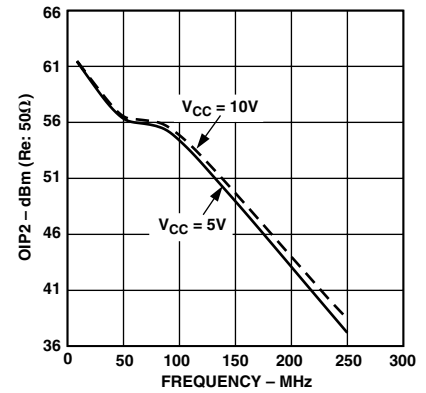

TPC 15. AD8350-20 Output Referred IP2 vs. Frequency

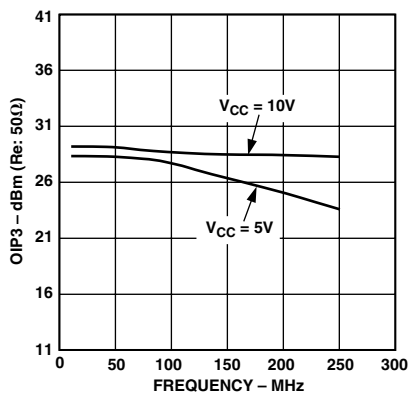

TPC 16. AD8350-15 Output Referred IP3 vs. Frequency

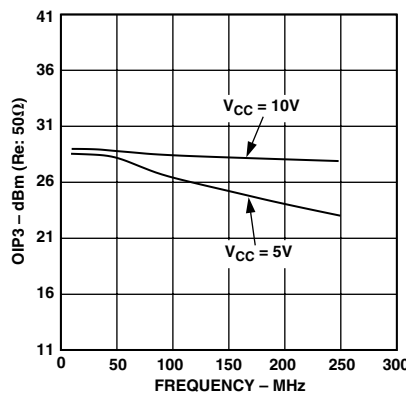

TPC 17. AD8350-20 Output Referred IP3 vs. Frequency

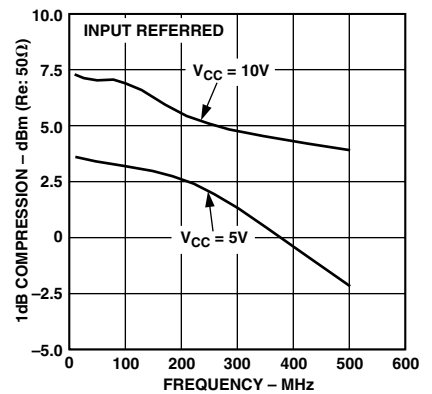

TPC 18. AD8350-15 1 dB Compression vs. Frequency

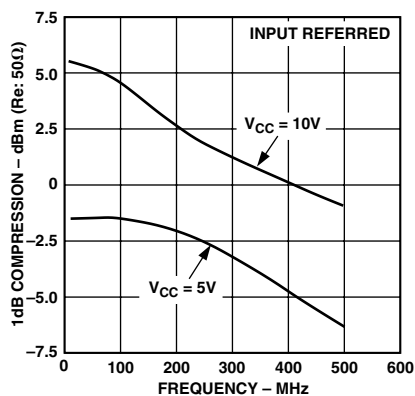

TPC 19. AD8350-20 1 dB Compression vs. Frequency

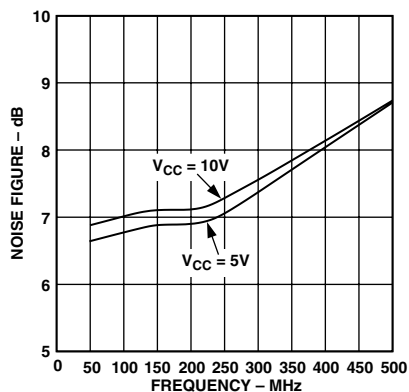

TPC 20. AD8350-15 Noise Figure vs. Frequency

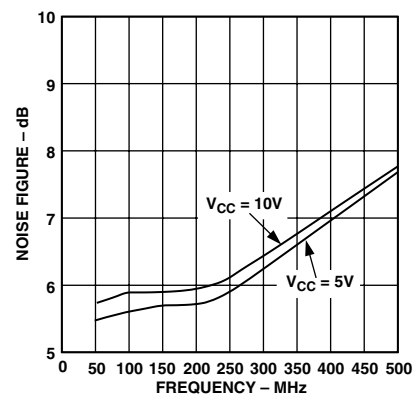

TPC 21. AD8350-20 Noise Figure vs. Frequency

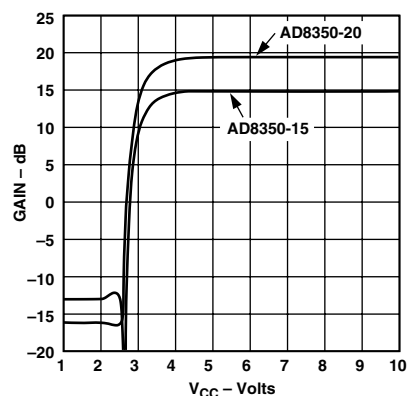

TPC 22. AD8350 Gain (S21) vs. Supply Voltage

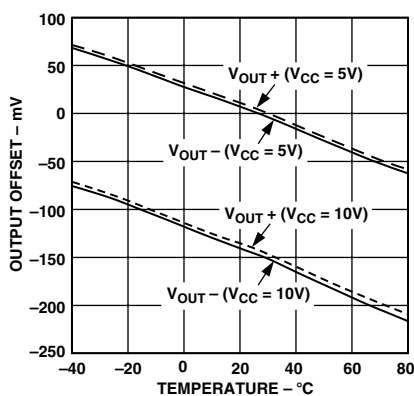

TPC 23. AD8350 Output Offset Voltage vs. Temperature

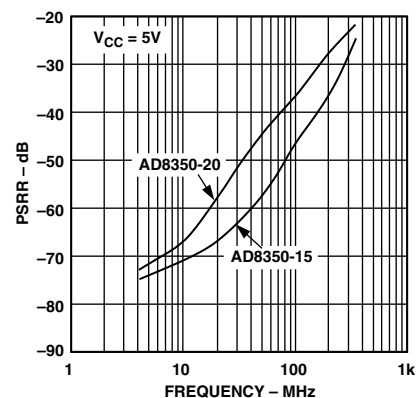

TPC 24. AD8350 PSRR vs. Frequency

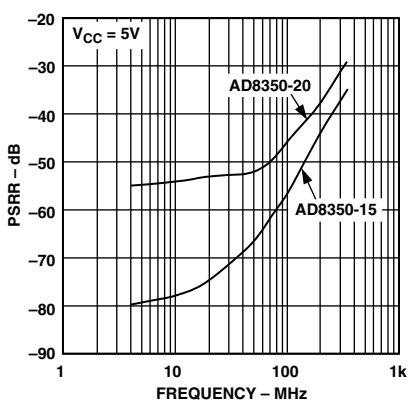

TPC 25. AD8350 CMRR vs. Frequency

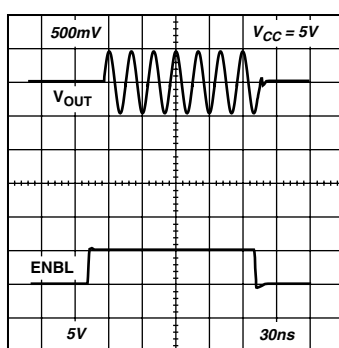

TPC 26. AD8350 Power-Up/Down Response Time

AD8350

APPLICATIONS

Using the AD8350

Figure 1 shows the basic connections for operating the AD8350. A single supply in the range 5 V to 10 V is required. The power supply pin should be decoupled using a 0.1 μF capacitor. The ENBL pin is tied to the positive supply or to 5 V (when $V_{\text{CC}} = 10\text{ V}$) for normal operation and should be pulled to ground to put the device in sleep mode. Both the inputs and the outputs have dc bias levels at midsupply and should be ac-coupled.

Also shown in Figure 1 are the impedance balancing requirements, either resistive or reactive, of the input and output. With an input and output impedance of 200 Ω , the AD8350 should be driven by a 200 Ω source and loaded by a 200 Ω impedance. A reactive match can also be implemented.

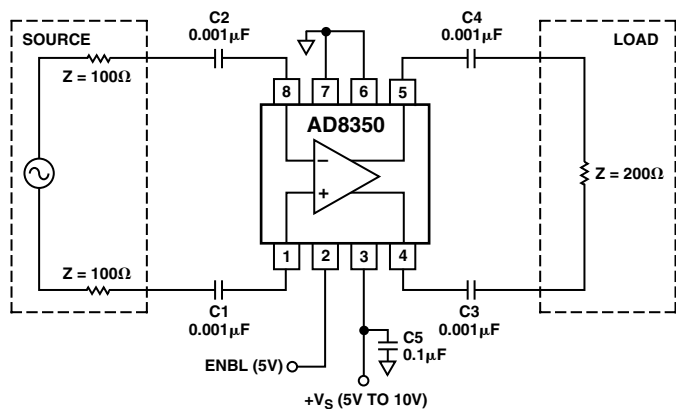

Figure 1. Basic Connections for Differential Drive

Figure 2 shows how the AD8350 can be driven by a single-ended source. The unused input should be ac-coupled to ground. When driven single-endedly, there will be a slight imbalance in the differential output voltages. This will cause an increase in the second order harmonic distortion (at 50 MHz, with $V_{\text{CC}} = 10\text{ V}$ and $V_{\text{OUT}} = 1\text{ V p-p}$, -59 dBc was measured for the second harmonic on AD8350-15).

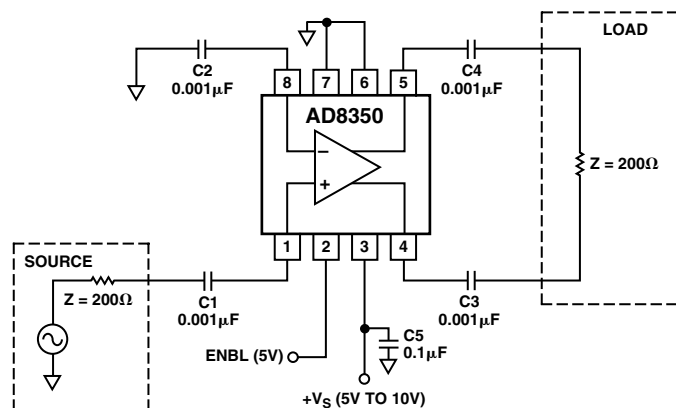

Figure 2. Basic Connections for Single-Ended Drive

Reactive Matching

In practical applications, the AD8350 will most likely be matched using reactive matching components as shown in Figure 3. Matching components can be calculated using a Smith Chart or by using a resonant approach to determine the matching network that results in a complex conjugate match. In either situation, the circuit can be analyzed as a single-ended equivalent circuit to ease calculations as shown in Figure 4.

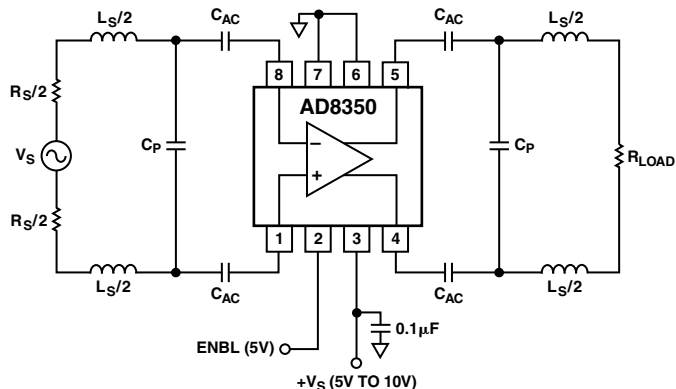

Figure 3. Reactively Matching the Input and Output

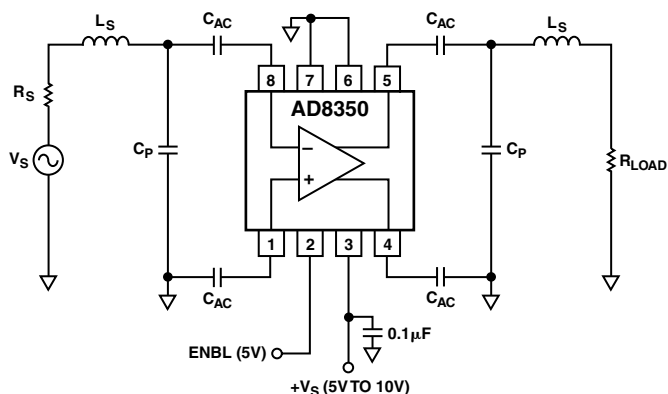

Figure 4. Single-Ended Equivalent Circuit

When the source impedance is smaller than the load impedance, a step-up matching network is required. A typical step-up network is shown on the input of the AD8350 in Figure 3. For purely resistive source and load impedances the resonant approach may be used. The input and output impedance of the AD8350 can be modeled as a real 200 Ω resistance for operating frequencies less than 100 MHz. For signal frequencies exceeding 100 MHz, classical Smith Chart matching techniques should be invoked in order to deal with the complex impedance relationships. Detailed S parameter data measured differentially in a 200 Ω system can be found in Tables II and III.

For the input matching network the source resistance is less than the input resistance of the AD8350. The AD8350 has a nominal 200 Ω input resistance from Pins 1 to 8. The reactance of the ac-coupling capacitors, C_{AC} , should be negligible if 100 nF capacitors are used and the lowest signal frequency is greater than 1 MHz. If the series reactance of the matching network inductor is defined to be $X_S = 2\pi f L_S$, and the shunt reactance of the matching capacitor to be $X_P = (2\pi f C_P)^{-1}$, then:

$$X_S = \frac{R_S \times R_{\text{LOAD}}}{X_P} \text{ where } X_P = R_{\text{LOAD}} \times \sqrt{\frac{R_S}{R_{\text{LOAD}} - R_S}} \quad (1)$$

For a 70 MHz application with a 50 Ω source resistance, and assuming the input impedance is 200 Ω , or $R_{\text{LOAD}} = R_{\text{IN}} = 200\ \Omega$, then $X_P = 115.5\ \Omega$ and $X_S = 86.6\ \Omega$, which results in the following component values:

$$C_P = (2\pi \times 70 \times 10^6 \times 115.5)^{-1} = 19.7\ \text{pF} \text{ and}$$

$$L_S = 86.6 \times (2\pi \times 70 \times 10^6)^{-1} = 197\ \text{nH}$$

For the output matching network, if the output source resistance of the AD8350 is greater than the terminating load resistance, a step-down network should be employed as shown on the output of Figure 3. For a step-down matching network, the series and parallel reactances are calculated as:

$$X_S = \frac{R_S \times R_{LOAD}}{X_P} \text{ where } X_P = R_S \times \sqrt{\frac{R_{LOAD}}{R_S - R_{LOAD}}} \quad (2)$$

For a 10 MHz application with the 200 Ω output source resistance of the AD8350, $R_S = 200 \Omega$, and a 50 Ω load termination, $R_{LOAD} = 50 \Omega$, then $X_P = 115.5 \Omega$ and $X_S = 86.6 \Omega$, which results in the following component values:

$$C_P = (2 \pi \times 10 \times 10^6 \times 115.5)^{-1} = 138 \text{ pF}$$

$$L_S = 86.6 \times (2 \pi \times 10 \times 10^6)^{-1} = 1.38 \text{ } \mu\text{H}$$

The same results can be obtained using the plots in Figure 5 and Figure 6. Figure 5 shows the normalized shunt reactance versus the normalized source resistance for a step-up matching network, $R_S < R_{LOAD}$. By inspection, the appropriate reactance can be found for a given value of R_S/R_{LOAD} . The series reactance is then calculated using $X_S = R_S R_{LOAD}/X_P$. The same technique can be used to design the step-down matching network using Figure 6.

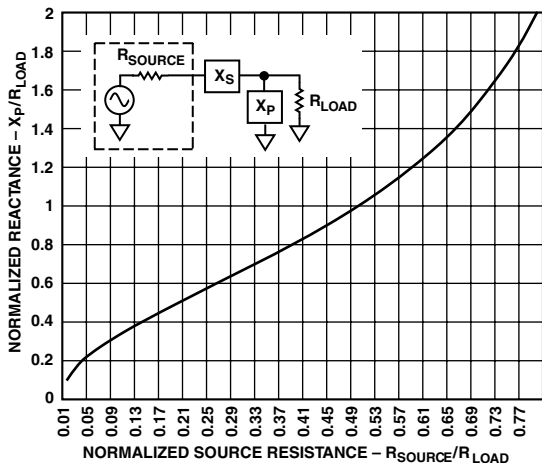

Figure 5. Normalized Step-Up Matching Components

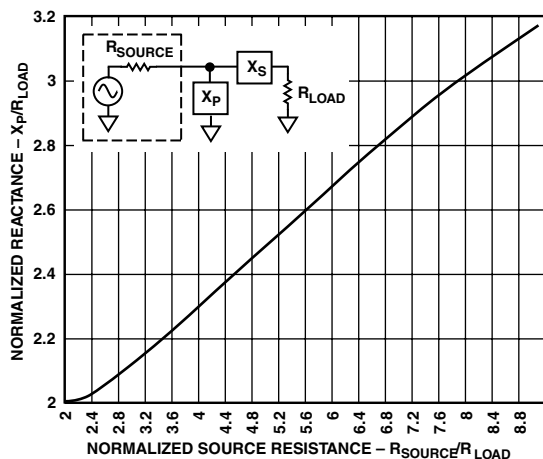

Figure 6. Normalized Step-Down Matching Components

The same results could be found using a Smith Chart as shown in Figure 7. In this example, a shunt capacitor and a series inductor are used to match the 200 Ω source to a 50 Ω load. For a frequency of 10 MHz, the same capacitor and inductor values previously found using the resonant approach will transform the 200 Ω source to match the 50 Ω load. At frequencies exceeding 100 MHz, the S parameters from Tables II and III should be used to account for the complex impedance relationships.

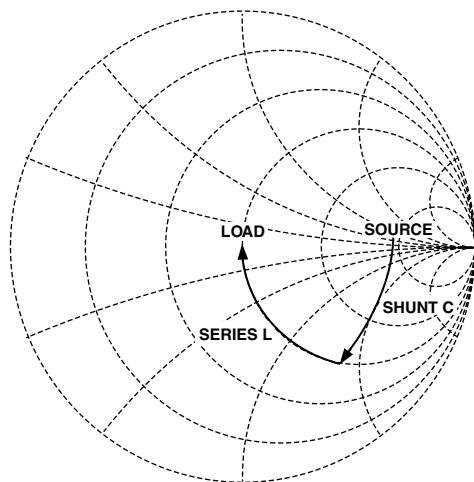

Figure 7. Smith Chart Representation of Step-Down Network

After determining the matching network for the single-ended equivalent circuit, the matching elements need to be applied in a differential manner. The series reactance needs to be split such that the final network is balanced. In the previous examples, this simply translates to splitting the series inductor into two equal halves as shown in Figure 3.

Gain Adjustment

The effective gain of the AD8350 can be reduced using a number of techniques. Obviously a matched attenuator network will reduce the effective gain, but this requires the addition of a separate component which can be prohibitive in size and cost. The attenuator will also increase the effective noise figure resulting in an SNR degradation. A simple voltage divider can be implemented using the combination of the driving impedance of the previous stage and a shunt resistor across the inputs of the AD8350 as shown in Figure 8. This provides a compact solution but suffers from an increased noise spectral density at the input of the AD8350 due to the thermal noise contribution of the shunt resistor. The input impedance can be dynamically altered through the use of feedback resistors as shown in Figure 9. This will result in a similar attenuation of the input signal by virtue of the voltage divider established from the driving source impedance and the reduced input impedance of the AD8350. Yet this technique does not significantly degrade the SNR with the unnecessary increase in thermal noise that arises from a truly resistive attenuator network.

AD8350

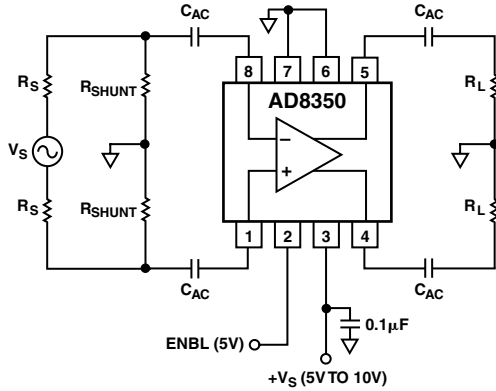

Figure 8. Gain Reduction Using Shunt Resistor

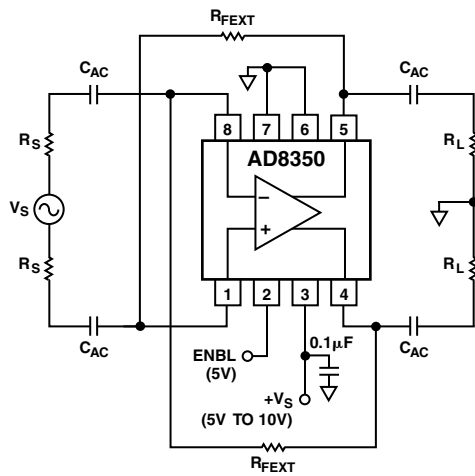

Figure 9. Dynamic Gain Reduction

Figure 8 shows a typical implementation of the shunt divider concept. The reduced input impedance that results from the parallel combination of the shunt resistor and the input impedance of the AD8350 adds attenuation to the input signal effectively reducing the gain. For frequencies less than 100 MHz, the input impedance of the AD8350 can be modeled as a real 200 Ω resistance (differential). Assuming the frequency is low enough to ignore the shunt reactance of the input, and high enough such that the reactance of moderately sized ac-coupling capacitors can be considered negligible, the insertion loss, IL, due to the shunt divider can be expressed as:

$$IL(dB) = 20 \times \text{Log}_{10} \left[\frac{\frac{R_{IN}}{(R_{IN} + R_S)}}{R_{IN} \parallel R_{SHUNT}} \right] \quad (3)$$

where

$$R_{IN} \parallel R_{SHUNT} = \frac{R_{IN} \times R_{SHUNT}}{R_{IN} + R_{SHUNT}} \text{ and } R_{IN} = 100 \Omega \text{ single-ended}$$

The insertion loss and the resultant power gain for multiple shunt resistor values is summarized in Table I. The source resistance and input impedance need careful attention when using Equation 1. The reactance of the input impedance of the AD8350 and the ac-coupling capacitors need to be considered before assuming they have negligible contribution. Figure 10 shows the effective power gain for multiple values of R_{SHUNT} for the AD8350-15 and AD8350-20.

Table I. Gain Adjustment Using Shunt Resistor, $R_S = 100 \Omega$ and $R_{IN} = 100 \Omega$ Single-Ended

$R_{SHUNT} - \Omega$	IL-dB	Power Gain-dB	
		AD8350-15	AD8350-20
50	6.02	8.98	13.98
100	3.52	11.48	16.48
200	1.94	13.06	18.06
300	1.34	13.66	18.66
400	1.02	13.98	18.98

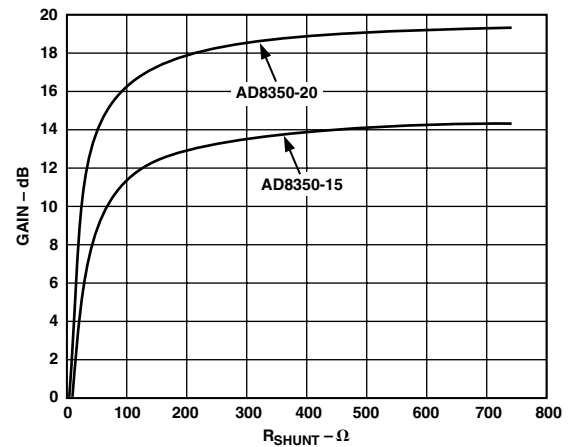

Figure 10. Gain for Multiple Values of Shunt Resistance for Circuit in Figure 8

The gain can be adjusted dynamically by employing external feedback resistors as shown in Figure 9. The effective attenuation is a result of the lowered input impedance as with the shunt resistor method, yet there is no additional noise contribution at the input of the device. It is necessary to use well-matched resistors to minimize common-mode offset errors. Quality 1% tolerance resistors should be used along with a symmetric board layout to help guarantee balanced performance. The effective gain for multiple values of external feedback resistors is shown in Figure 11.

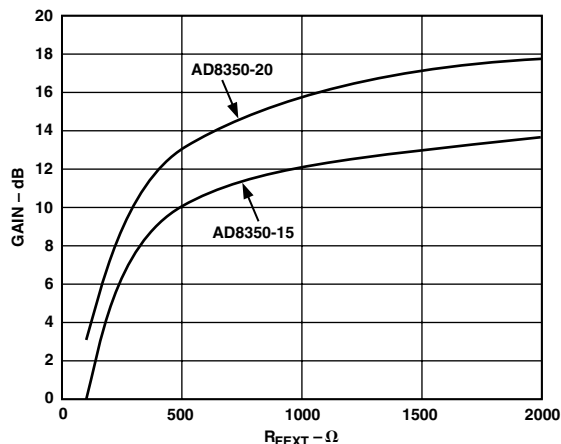

Figure 11. Power Gain vs. External Feedback Resistors for the AD8350-15 and AD8350-20 with $R_S = 100 \Omega$ and $R_L = 100 \Omega$

The power gain of any two-port network is dependent on the source and load impedance. The effective gain will change if the differential source and load impedance is not 200Ω . The single-ended input and output resistance of the AD8350 can be modeled using the following equations:

$$R_{IN} = \frac{R_F + R_L}{\left(\frac{R_F + R_L}{R_{INT}}\right) + 1 + g_m \times R_L} \quad (4)$$

and

$$R_{OUT} = \frac{R_F + \frac{1}{\frac{1}{R_S} + \frac{1}{R_{INT}}}}{1 + g_m \times \left(\frac{1}{\frac{1}{R_S} + \frac{1}{R_{INT}}}\right)} \approx \frac{R_F + R_S}{1 + g_m \times R_S} \text{ for } R_S \leq 1 \text{ k}\Omega \quad (5)$$

where

- $R_F = R_{FEXT} // R_{FINT}$
- $R_{FEXT} = R$ Feedback External
- $R_{FINT} = 662 \Omega$ for the AD8350-15
- $R_{FINT} = 1100 \Omega$ for the AD8350-20
- $R_{INT} = 25000 \Omega$
- $g_m = 0.066$ mhos for the AD8350-15
- $g_m = 0.110$ mhos for the AD8350-20
- $R_S = R$ Source (Single-Ended)
- $R_L = R$ Load (Single-Ended)
- $R_{IN} = R$ Input (Single-Ended)
- $R_{OUT} = R$ Output (Single-Ended)

The resultant single-ended gain can be calculated using the following equation:

$$G_V = \frac{R_L \times (g_m \times R_F - 1)}{R_L + R_S + R_F + R_L \times R_S \times g_m} \quad (6)$$

Driving Lighter Loads

It is not necessary to load the output of the AD8350 with a 200Ω differential load. Often it is desirable to try to achieve a complex conjugate match between the source and load in order to minimize reflections and conserve power. But if the AD8350 is driving a voltage responding device, such as an ADC, it is no longer necessary to maximize power transfer. The harmonic distortion performance will actually improve when driving loads greater than 200Ω . The lighter load requires less current driving capability on the output stages of the AD8350 resulting in improved linearity. Figure 12 shows the improvement in second and third harmonic distortion for increasing differential load resistance.

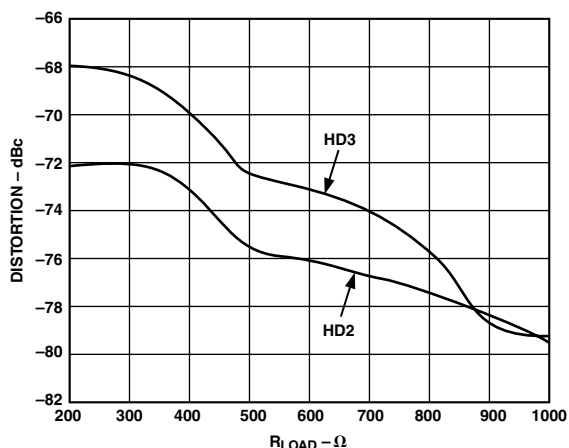

Figure 12. Second and Third Harmonic Distortion vs. Differential Load Resistance for the AD8350-15 with $V_S = 5 \text{ V}$, $f = 70 \text{ MHz}$, and $V_{OUT} = 1 \text{ V p-p}$

Table II. Typical Scattering Parameters for the AD8350-15: $V_{CC} = 5$ V, Differential Input and Output, $Z_{SOURCE}(\text{diff}) = 200 \Omega$, $Z_{LOAD}(\text{diff}) = 200 \Omega$

Frequency – MHz	S11	S12	S21	S22
25	0.015 \angle -48.8°	0.119 \angle 176.3°	5.60 \angle -4.3°	0.034 \angle -4.8°
50	0.028 \angle -65.7°	0.119 \angle 171.1°	5.61 \angle -8.9°	0.032 \angle -14.3°
75	0.043 \angle -75.3°	0.119 \angle 166.9°	5.61 \angle -13.5°	0.036 \angle -30.2°
100	0.057 \angle -87.5°	0.120 \angle 163.5°	5.61 \angle -17.9°	0.043 \angle -39.6°
125	0.073 \angle -91.8°	0.119 \angle 159.8°	5.65 \angle -22.6°	0.053 \angle -40.6°
150	0.080 \angle -95.6°	0.120 \angle 154.8°	5.68 \angle -27.0°	0.058 \angle -37°
175	0.100 \angle -97.4°	0.117 \angle 151.2°	5.73 \angle -31.8°	0.072 \angle -45.1°
200	0.111 \angle -99.1°	0.121 \angle 147.3°	5.78 \angle -36.3°	0.077 \angle -47.7°
225	0.128 \angle -103.2°	0.120 \angle 143.7°	5.83 \angle -41.0°	0.091 \angle -52.5°
250	0.141 \angle -106.7°	0.120 \angle 140.3°	5.90 \angle -45.6°	0.104 \angle -55.1°
275	0.151 \angle -109.7°	0.120 \angle 136.6°	6.02 \angle -50.2°	0.108 \angle -54.2°
300	0.161 \angle -111.9°	0.123 \angle 132.9°	6.14 \angle -55.1°	0.122 \angle -51.5°
325	0.179 \angle -114.7°	0.121 \angle 130.7°	6.19 \angle -60.2°	0.135 \angle -55.6°
350	0.187 \angle -117.4°	0.122 \angle 126.6°	6.27 \angle -65.0°	0.150 \angle -56.9°
375	0.194 \angle -121°	0.123 \angle 123.6°	6.43 \angle -70.1°	0.162 \angle -60.9°
400	0.199 \angle -121.2°	0.124 \angle 120.1°	6.61 \angle -75.8°	0.187 \angle -60.3°
425	0.215 \angle -122.6°	0.126 \angle 117.2°	6.77 \angle -81.7°	0.215 \angle -63.3°
450	0.225 \angle -127.0°	0.126 \angle 113.9°	6.91 \angle -87.6°	0.242 \angle -63.9°
475	0.225 \angle -127.7°	0.126 \angle 112°	7.06 \angle -93.8°	0.268 \angle -65.2°
500	0.244 \angle -129.9°	0.128 \angle 108.1°	7.27 \angle -99.8°	0.304 \angle -68.2°

Table III. Typical Scattering Parameters for the AD8350-20: $V_{CC} = 5$ V, Differential Input and Output, $Z_{SOURCE}(\text{diff}) = 200 \Omega$, $Z_{LOAD}(\text{diff}) = 200 \Omega$

Frequency – MHz	S11	S12	S21	S22
25	0.017 \angle -142.9°	0.074 \angle 174.9°	9.96 \angle -4.27°	0.023 \angle -16.6°
50	0.033 \angle -114.9°	0.074 \angle 171.0°	9.98 \angle -8.9°	0.022 \angle -2.7°
75	0.055 \angle -110.6°	0.075 \angle 167.0°	9.98 \angle -13.3°	0.023 \angle -23.5°
100	0.073 \angle -109.4°	0.075 \angle 163.1°	10.00 \angle -17.7°	0.029 \angle -22.7°
125	0.089 \angle -112.1°	0.075 \angle 159.2°	10.12 \angle -22.1°	0.037 \angle -18.0°
150	0.098 \angle -116.5°	0.076 \angle 153.8°	10.20 \angle -26.4°	0.045 \angle -3.2°
175	0.124 \angle -118.1°	0.075 \angle 150.2°	10.34 \angle -30.9°	0.055 \angle -15.7°
200	0.141 \angle -119.4°	0.076 \angle 147.2°	10.50 \angle -35.6°	0.065 \angle -15.6°
225	0.159 \angle -122.6°	0.077 \angle 142.2°	10.65 \angle -40.1°	0.080 \angle -17.7°
250	0.170 \angle -128.5°	0.078 \angle 139.5°	10.80 \angle -44.7°	0.085 \angle -22.4°
275	0.186 \angle -131.6°	0.078 \angle 135.8°	11.14 \angle -49.3°	0.096 \angle -23.5°
300	0.203 \angle -132.9°	0.080 \angle 132.5°	11.45 \angle -54.7°	0.116 \angle -25.9°
325	0.215 \angle -135.0°	0.080 \angle 129.3°	11.70 \angle -60.3°	0.139 \angle -29.6°
350	0.222 \angle -136.9°	0.082 \angle 125.9°	11.93 \angle -65.0°	0.161 \angle -32.2°
375	0.242 \angle -142.4°	0.082 \angle 123.6°	12.39 \angle -70.3°	0.173 \angle -38.6°
400	0.240 \angle -145.2°	0.084 \angle 120.3°	12.99 \angle -76.8°	0.207 \angle -37.6°
425	0.267 \angle -146.7°	0.084 \angle 117.3°	13.34 \angle -84.0°	0.241 \angle -48.1°
450	0.266 \angle -150.7°	0.086 \angle 115.1°	13.76 \angle -90.1°	0.265 \angle -49.7°
475	0.267 \angle -153.7°	0.087 \angle 112.8°	14.34 \angle -97.5°	0.317 \angle -53.5°
500	0.285 \angle -161.1°	0.088 \angle 110.9°	14.89 \angle -105.0°	0.359 \angle -59.2°

OUTLINE DIMENSIONS

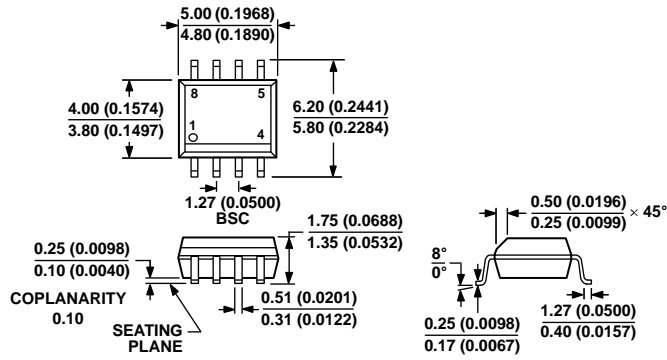

COMPLIANT TO JEDEC STANDARDS MS-012-AA
 CONTROLLING DIMENSIONS ARE IN MILLIMETERS; INCH DIMENSIONS (IN PARENTHESES) ARE ROUNDED-OFF MILLIMETER EQUIVALENTS FOR REFERENCE ONLY AND ARE NOT APPROPRIATE FOR USE IN DESIGN.

Figure 14. 8-Lead Standard Small Outline Package [SOIC_N] Narrow Body (R-8)

Dimensions shown in millimeters and (inches)

012407-A

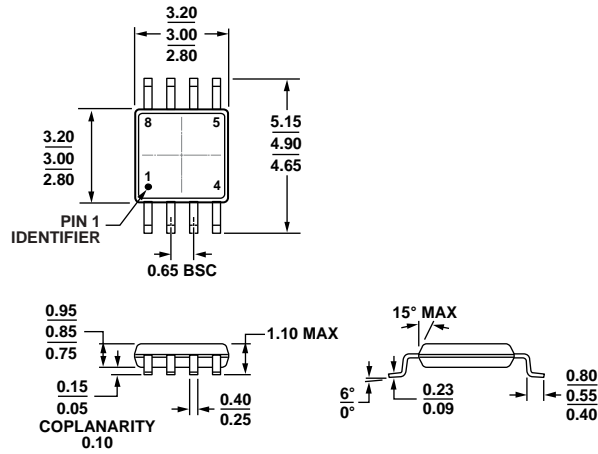

COMPLIANT TO JEDEC STANDARDS MO-187-AA

Figure 15. 8-Lead Mini Small Outline Package [MSOP] (RM-8)

Dimensions shown in millimeters

10-07-2009-B

ORDERING GUIDE

Model ¹	Temperature Range	Package Description	Package Option	Branding
AD8350ARZ15-REEL7	-40°C to +85°C	8-Lead SOIC_N	R-8	
AD8350ARMZ15	-40°C to +85°C	8-Lead MSOP	RM-8	Q0T
AD8350ARMZ15-REEL7	-40°C to +85°C	8-Lead MSOP	RM-8	Q0T
AD8350ARMZ20	-40°C to +85°C	8-Lead MSOP	RM-8	Q0U
AD8350ARMZ20-REEL7	-40°C to +85°C	8-Lead MSOP	RM-8	Q0U
AD8350ARMZ0-REEL7	-40°C to +85°C	8-Lead MSOP	RM-8	J2P
AD8350ARZ20-REEL7	-40°C to +85°C	8-Lead SOIC_N	R-8	

¹ Z = RoHS Compliant Part.

REVISION HISTORY**5/13—Rev. A to Rev. B**

Deleted Evaluation Board Section.....	12
Updated Outline Dimensions	13
Changes to Ordering Guide	14

6/01—Rev. 0 to Rev. A

Mouser Electronics

Authorized Distributor

Click to View Pricing, Inventory, Delivery & Lifecycle Information:

[Analog Devices Inc.:](#)

[AD8350ARMZ15](#) [AD8350ARMZ20](#) [AD8350ARMZ15-REEL7](#) [AD8350ARMZ20-REEL7](#) [AD8350ARZ15-REEL7](#)
[AD8350ARZ20-REEL7](#)