

FEATURES

Comparators with 0.6 V on-chip references

Output stages

Open-drain active low ([ADCMP350](#))

Open-drain active high ([ADCMP354](#))

Push-pull active high ([ADCMP356](#))

High voltage (up to 22 V) tolerance on V_{IN} and open-drain output pins

Low power consumption: 10 μ A

10 nA input bias current

15 mV hysteresis

5 μ s propagation delay

Specified over -40°C to $+125^{\circ}\text{C}$ temperature range

4-lead SC70 package

APPLICATIONS

Voltage detectors

Microprocessor systems

Computers

Battery monitors

Intelligent instruments

Portable equipment

GENERAL DESCRIPTION

The [ADCMP350/ADCMP354/ADCMP356](#) are comparator and reference circuits suitable for use in general-purpose applications. The high voltage input and output structures allow voltages of up to 22 V on the input of all devices and the output of the open-drain devices. High performance over the -40°C to $+125^{\circ}\text{C}$ temperature range makes them suitable for use in automotive and other thermally harsh applications, while low power consumption and space-efficient SC70 packaging make them ideal for battery-powered portable equipment.

FUNCTIONAL BLOCK DIAGRAMS

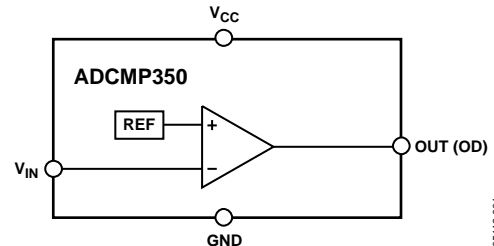

Figure 1. [ADCMP350](#) Functional Block Diagram

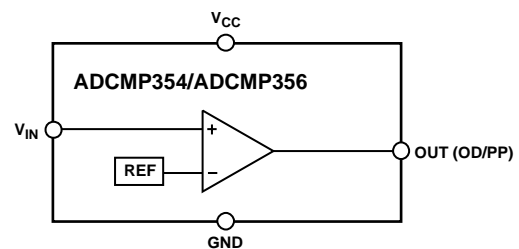

Figure 2. [ADCMP354/ADCMP356](#) Functional Block Diagram

Table 1. Selection Table

Part No.	Reference Voltage (V)	Input Connection	Output
ADCMP350	0.6	Inverting	Open-drain
ADCMP354	0.6	Noninverting	Open-drain
ADCMP356	0.6	Noninverting	Push-pull

TABLE OF CONTENTS

Features	1	Pin Configuration and Function Descriptions.....	5
Applications.....	1	Typical Performance Characteristics	6
Functional Block Diagrams.....	1	Applications Information	9
General Description	1	Adding Hysteresis.....	9
Revision History	2	Voltage Detector	9
Specifications.....	3	Outline Dimensions	10
Absolute Maximum Ratings.....	4	Ordering Guide	10
ESD Caution.....	4		

REVISION HISTORY

4/16—Rev. C to Rev. D	
Changes to Figure 13 Caption and Figure 14 Caption	7
Updated Outline Dimensions	10
5/15—Rev. B to Rev. C	
Changes to Adding Hysteresis Section, Figure 20, and Figure 21	9
Changes to Ordering Guide	10
4/11—Rev. A to Rev. B	
Deleted ADCMP352	Universal
Changes to Adding Hysteresis Section, Figure 20, and Figure 21	9
11/09—Rev. 0 to Rev. A	
Changes to Ordering Guide	10
10/04—Revision 0: Initial Version	

SPECIFICATIONS

V_{CC} = full operating range, T_A = -40°C to $+125^{\circ}\text{C}$, unless otherwise noted.

Table 2.

Parameter	Min	Typ	Max	Unit	Test Conditions/Comments
SUPPLY					
V_{CC} Operating Voltage Range	2.25		5.5	V	
V_{IN} Operating Voltage Range	0		22	V	
Supply Current		10	15	μA	
V_{IN} THRESHOLD RISING	0.579	0.6	0.621	V	$V_{CC} = 3.3\text{ V}$, $T_A = -40^{\circ}\text{C}$ to $+85^{\circ}\text{C}$
	0.579	0.6	0.624	V	$V_{CC} = 3.3\text{ V}$, $T_A = -40^{\circ}\text{C}$ to $+125^{\circ}\text{C}$
V_{IN} THRESHOLD FALLING	0.564	0.585	0.606	V	$V_{CC} = 3.3\text{ V}$, $T_A = -40^{\circ}\text{C}$ to $+85^{\circ}\text{C}$
	0.564	0.585	0.609	V	$V_{CC} = 3.3\text{ V}$, $T_A = -40^{\circ}\text{C}$ to $+125^{\circ}\text{C}$
INPUT BIAS CURRENT		10		nA	$V_{IN} = 0.6\text{ V}$
		170		μA	$V_{IN} = 22\text{ V}$
THRESHOLD TEMPERATURE COEFFICIENT		30		ppm/ $^{\circ}\text{C}$	
V_{IN} TO OUT DELAY		5		μs	$V_{IN} = V_{TH}$ to $(V_{TH} - 100\text{ mV})$
OUT VOLTAGE LOW			0.4	V	$V_{IN} < V_{TH}$ minimum, $I_{SINK} = 1.2\text{ mA}$
OUT VOLTAGE HIGH	$0.8 \times V_{CC}$			V	$V_{IN} > V_{TH}$ maximum, $I_{SOURCE} = 500\ \mu\text{A}$, Push-pull only
OUTPUT RISE TIME		30		ns	$C_{OUT} = 15\text{ pF}$
OUTPUT FALL TIME		45		ns	$C_{OUT} = 15\text{ pF}$
OUTPUT LEAKAGE CURRENT			1	μA	OUT = 22 V, open-drain only

ABSOLUTE MAXIMUM RATINGS

$T_A = 25^\circ\text{C}$, unless otherwise noted.

Table 3.

Parameter	Rating
V_{CC}	-0.3 V to +6 V
V_{IN}	-0.3 V to +25 V
OUT (Open-Drain)	-0.3 V to +25 V
OUT (Push-Pull)	-0.3 V to ($V_{CC} + 0.3$ V)
Operating Temperature Range	-40°C to +125°C
Storage Temperature Range	-65°C to +150°C
θ_{JA} Thermal Impedance, SC70	146°C/W
Lead Temperature	
Soldering (10 sec)	300°C
Vapor Phase (60 sec)	215°C
Infrared (15 sec)	220°C

Stresses at or above those listed under Absolute Maximum Ratings may cause permanent damage to the product. This is a stress rating only; functional operation of the product at these or any other conditions above those indicated in the operational section of this specification is not implied. Operation beyond the maximum operating conditions for extended periods may affect product reliability.

ESD CAUTION



ESD (electrostatic discharge) sensitive device. Charged devices and circuit boards can discharge without detection. Although this product features patented or proprietary protection circuitry, damage may occur on devices subjected to high energy ESD. Therefore, proper ESD precautions should be taken to avoid performance degradation or loss of functionality.

PIN CONFIGURATION AND FUNCTION DESCRIPTIONS

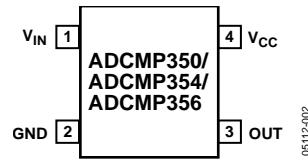

Figure 3. Pin Configuration

Table 4. Pin Function Descriptions

Pin No.	Mnemonic	Description
1	V _{IN}	Monitors Analog Input Voltage. Connected to inverting or noninverting input depending on the model number.
2	GND	Ground.
3	OUT	Digital Output. Open-drain or push-pull options depending on the model number.
4	V _{CC}	Power Supply.

TYPICAL PERFORMANCE CHARACTERISTICS

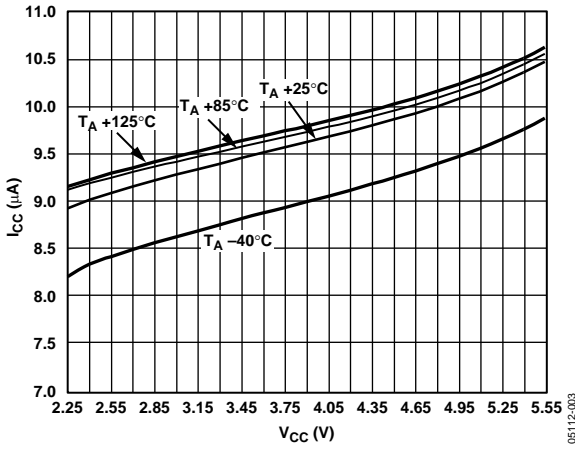

Figure 4. I_{CC} vs. V_{CC} over Temperature

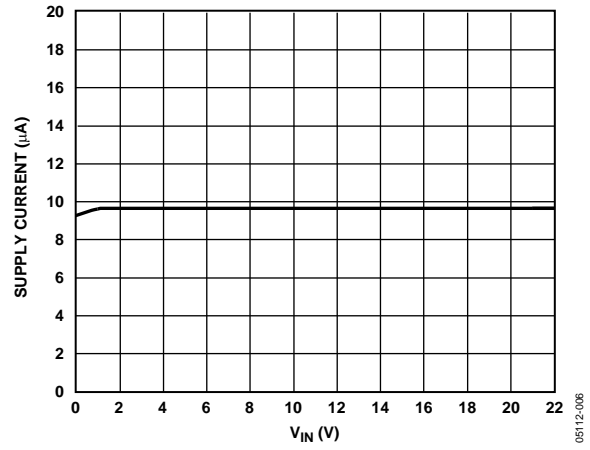

Figure 7. Supply Current vs. Input Voltage (V_{IN})

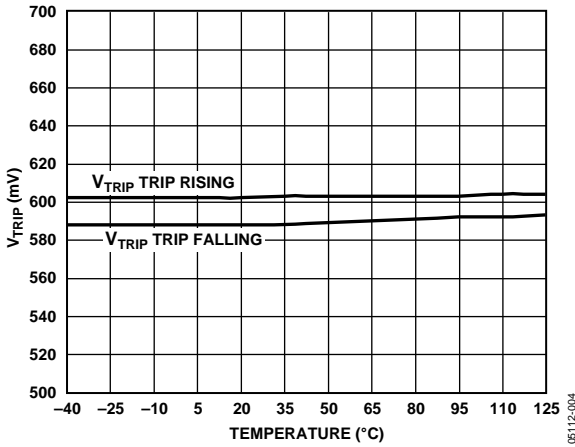

Figure 5. V_{IN} Trip Threshold vs. Temperature ($V_{CC} = 3.3 V$)

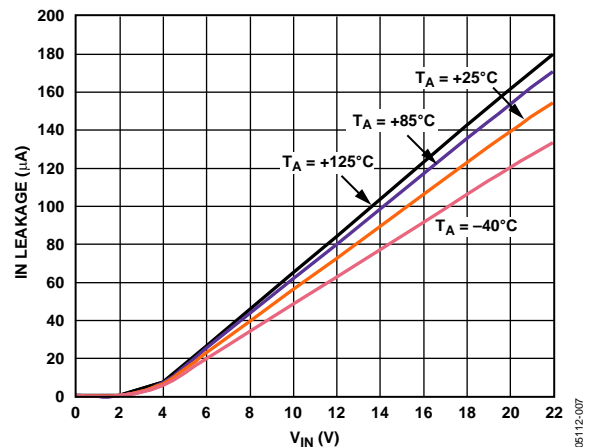

Figure 8. Input Leakage vs. Input Voltage (V_{IN})

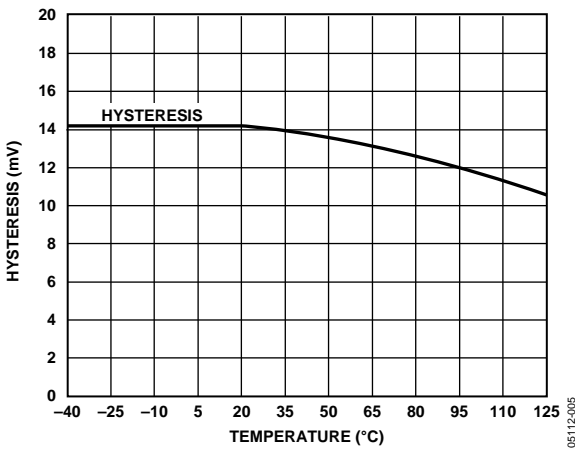

Figure 6. V_{IN} Trip Hysteresis vs. Temperature

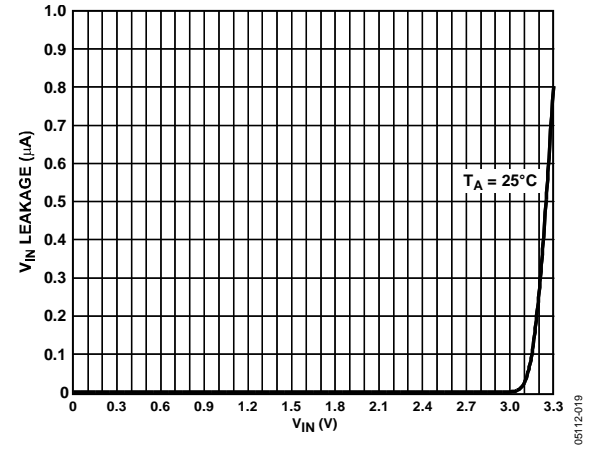

Figure 9. V_{IN} Leakage Current vs. V_{IN} Voltage ($V_{CC} = 3.8 V$)

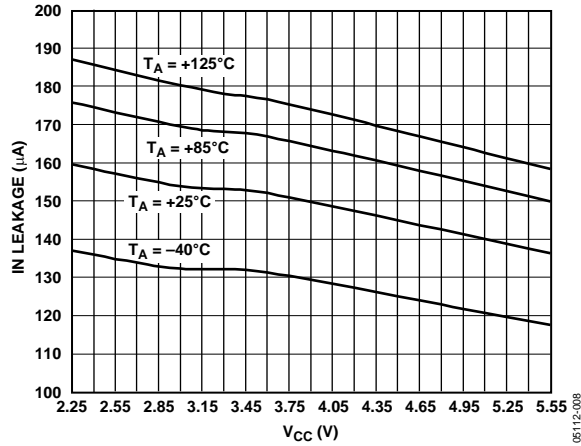

Figure 10. Input Leakage vs. Supply Voltage, V_{CC} ($V_{IN} = 22\text{ V}$)

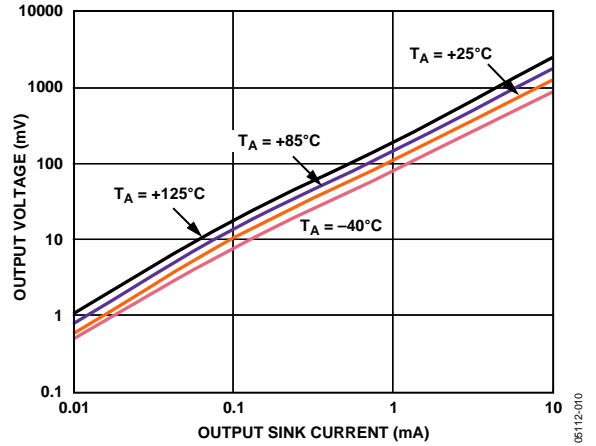

Figure 13. Output Voltage vs. Output Sink Current

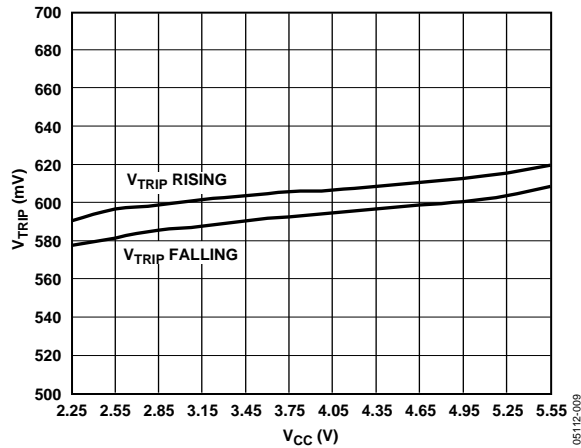

Figure 11. V_{IN} Trip Threshold vs. V_{CC}

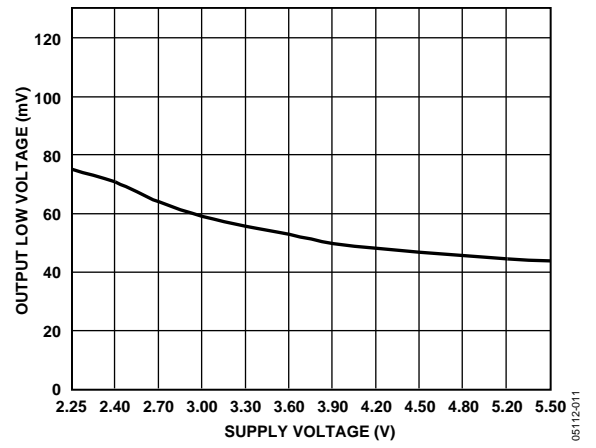

Figure 14. Output Low Voltage vs. Supply Voltage ($I_{SINK} = 500\text{ }\mu\text{A}$)

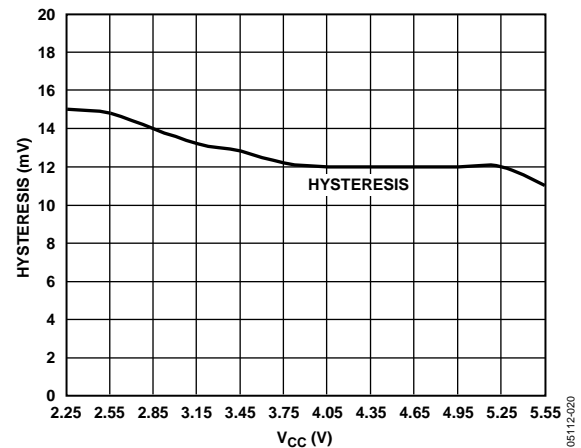

Figure 12. V_{IN} Trip Hysteresis vs. V_{CC}

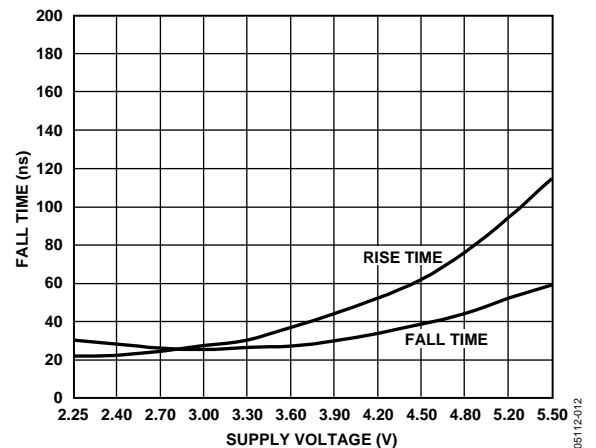

Figure 15. Fall Time vs. Supply Voltage

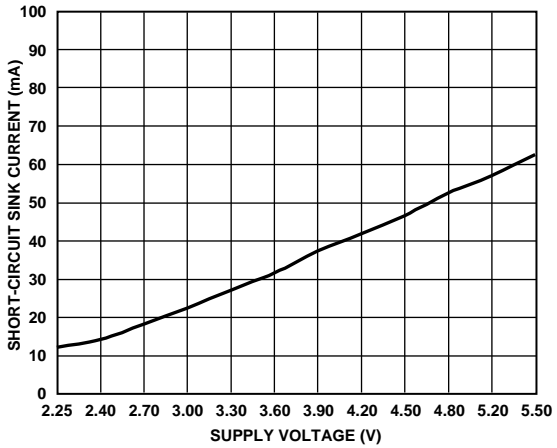

Figure 16. Short-Circuit Sink Current vs. Supply Voltage ($V_{CC} = 3.3\text{ V}$, Push-Pull Only)

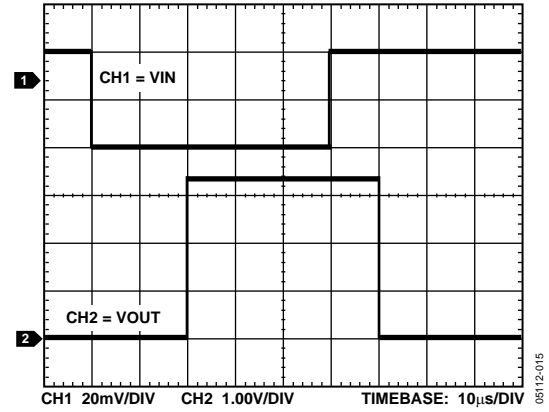

Figure 18. Propagation Delay Timing, 10 mV Overdrive

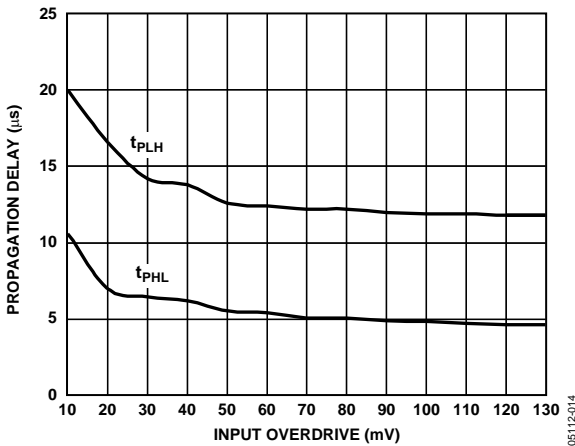

Figure 17. Propagation Delay vs. Input Overdrive ($V_{CC} = 3.3\text{ V}$, Push-Pull Only)

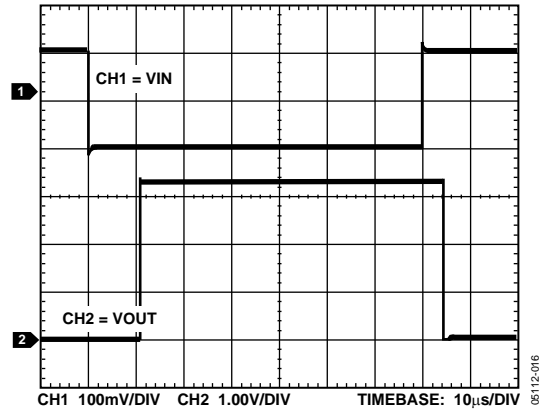

Figure 19. Propagation Delay Timing, 100 mV Overdrive

APPLICATIONS INFORMATION

ADDING HYSTERESIS

To prevent oscillations at the output caused by noise or slowly moving signals passing the switching threshold, positive feedback can be used to add hysteresis to the noninverting parts (ADCMP354 and ADCMP356).

For the noninverting configuration shown in Figure 20, two resistors are used to create different switching thresholds, depending on whether the input signal is increasing or decreasing in magnitude. When the input voltage is increasing, the threshold is above V_{REF} , and when it is decreasing, the threshold is below V_{REF} .

The upper input threshold level is given by

$$V_{IN_HI} = \frac{V_{REF}(R1 + R2)}{R2}$$

where $V_{REF} = 0.6$ V, assuming $R_{LOAD} \gg R2, R_{PULLUP}$

The lower input threshold level is given by

$$V_{IN_LO} = \frac{V_{REF}(R1 + R2 + R_{PULLUP}) - V_{CC}R1}{R2 + R_{PULLUP}}$$

The hysteresis is the difference between these voltage levels and is given by

$$V_{HYS} = \frac{V_{REF}(R1)}{R2} - \frac{R1(V_{REF} + V_{CC})}{R2 + R_{PULLUP}}$$

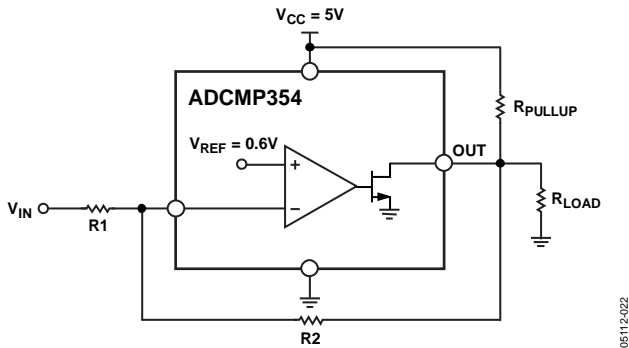

Figure 20. Noninverting Comparator Configuration with Added Hysteresis

VOLTAGE DETECTOR

The ADCMP350/ADCMP354/ADCMP356 can be used to monitor voltages, such as battery monitoring or threshold detectors. Using a resistor divider at the input to select the appropriate trip voltage, the comparator can be configured to give a logic output when the input passes that threshold. Figure 21 shows the typical configuration of the ADCMP354 for monitoring a supply to indicate that the voltage is above a certain level.

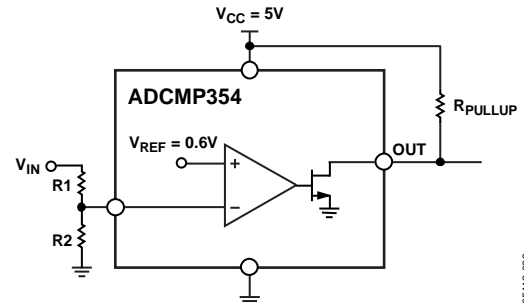
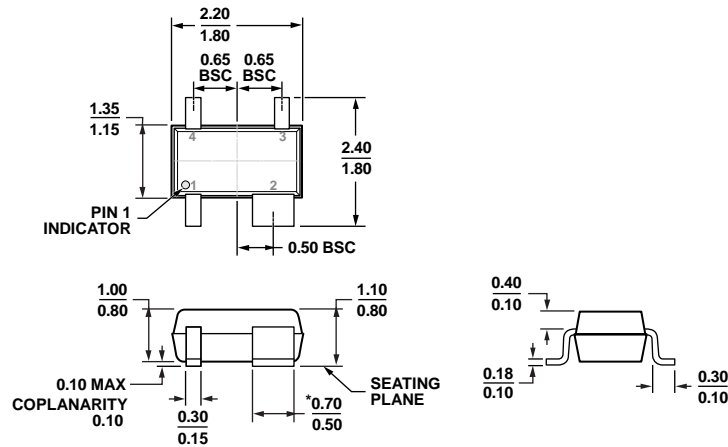

Figure 21. Voltage Detector Application

OUTLINE DIMENSIONS



*PACKAGE OUTLINE CORRESPONDS IN FULL TO EIAJ SC82 EXCEPT FOR WIDTH OF PIN 2 AS SHOWN.

Figure 22. 4-Lead Thin Shrink Small Outline Transistor Package [SC70] (KS-4)

Dimensions shown in millimeters

03-04-2014-B

ORDERING GUIDE

Model ¹	Temperature Range	Package Description	Package Option	Branding
ADCMP350YKS-REEL7	-40°C to +125°C	4-Lead Thin Shrink Small Outline Transistor Package [SC70]	KS-4	M0Z
ADCMP350YKSZ-REEL7	-40°C to +125°C	4-Lead Thin Shrink Small Outline Transistor Package [SC70]	KS-4	M55
ADCMP354YKSZ-REEL7	-40°C to +125°C	4-Lead Thin Shrink Small Outline Transistor Package [SC70]	KS-4	M56
ADCMP356YKSZ-REEL7	-40°C to +125°C	4-Lead Thin Shrink Small Outline Transistor Package [SC70]	KS-4	M8V

¹ Z = RoHS Compliant Part.

NOTES

NOTES

Mouser Electronics

Authorized Distributor

Click to View Pricing, Inventory, Delivery & Lifecycle Information:

[Analog Devices Inc.:](#)

[ADCMP350YKSZ-REEL7](#) [ADCMP354YKSZ-REEL7](#) [ADCMP350YKS-REEL7](#) [ADCMP354YKS-REEL7](#)
[ADCMP356YKSZ-REEL7](#)