

FEATURES

- Input voltage: 4.5 V to 18 V
- ±1.0% output accuracy
- Integrated MOSFET: 110 mΩ/60 mΩ typical
- Continuous output current: 1 A/1 A
- Power fail comparator generates warning
- Power-on reset with programmable delay timer
- Adjustable voltage monitor for power-down (Channel 2)
- Watchdog refresh input
- Dual phase with 180° out-of-phase operation
- Fixed switching frequency: 300 kHz
- Internal compensation and soft start
- Stable with low ESR output ceramic capacitors
- Precision enable input
- Power feedback during power-off
- UVLO, OCP, OVP, and thermal shutdown protection

APPLICATIONS

- Industrial and instrumentation
- Healthcare and medical
- DC-to-DC point of load applications

GENERAL DESCRIPTION

The **ADP2311** is a fully integrated, dual output, synchronous step-down dc-to-dc regulator. The regulator operates from input voltages of 4.5 V to 18 V, and the output can regulate down to 0.6 V. Each channel can provide up to 1 A of continuous output current.

The **ADP2311** integrates the high-side and low-side MOSFETs to provide a very high efficiency, compact solution. Both channels of the regulator run at 180° out of phase to reduce the input ripple current and the input capacitor size, thereby helping to lower system electromagnetic interference (EMI). The **ADP2311** also integrates internal compensation and soft start circuitry to simplify the design.

TYPICAL APPLICATION CIRCUIT

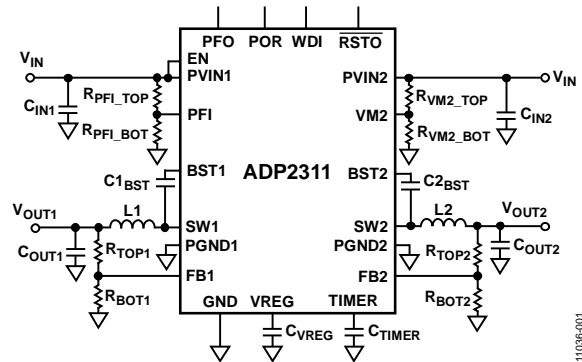

Figure 1.

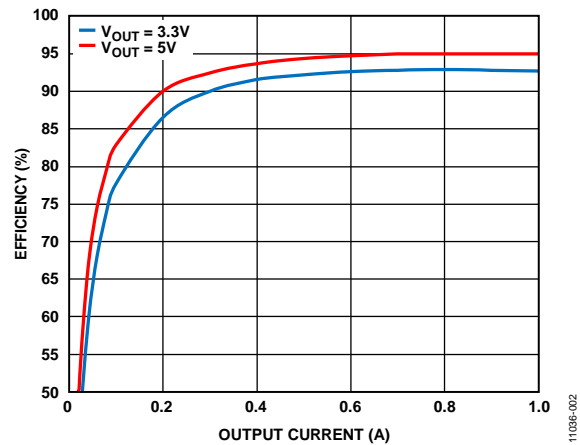

Figure 2. Efficiency vs. Output Current at $V_{IN} = 12\text{ V}$, $f_{sw} = 300\text{ kHz}$

An on-chip watchdog timer can reset the microprocessor if it fails to strobe within a preset timeout period. Accurate voltage monitoring circuitry and a power fail comparator provide a controlled power-up and power-down sequence to enhance system reliability.

The **ADP2311** also includes undervoltage lockout (UVLO), overvoltage protection (OVP), overcurrent protection (OCP), and thermal shutdown (TSD).

The **ADP2311** operates over the -40°C to $+125^{\circ}\text{C}$ junction temperature range and is available in a 24-lead LFCSP package.

TABLE OF CONTENTS

Features	1	Peak Current-Limit and Short-Circuit Protection	13
Applications.....	1	Power-On Reset (POR)	13
Typical Application Circuit	1	TIMER Pin Configuration	14
General Description	1	Power Fail Comparator.....	15
Revision History	2	Voltage Monitor Comparator (VM2)	15
Functional Block Diagram	3	Watchdog Timer.....	15
Specifications.....	4	Power-Up and Power-Down Sequence	15
Absolute Maximum Ratings.....	6	Overvoltage Protection (OVP)	15
Thermal Resistance	6	Undervoltage Lockout (UVLO)	15
ESD Caution.....	6	Thermal Shutdown	16
Pin Configuration and Function Descriptions.....	7	Applications Information	17
Typical Performance Characteristics	8	Input Capacitor Selection.....	17
Theory of Operation	13	Output Voltage Setting	17
Control Scheme	13	Inductor Selection	17
Precision Enable/Shutdown	13	Output Capacitor Selection.....	18
Internal Regulator (VREG).....	13	Application Circuit.....	19
Bootstrap Circuitry	13	Outline Dimensions	20
Soft Start	13	Ordering Guide	20

REVISION HISTORY

3/14—Revision A: Initial Version

FUNCTIONAL BLOCK DIAGRAM

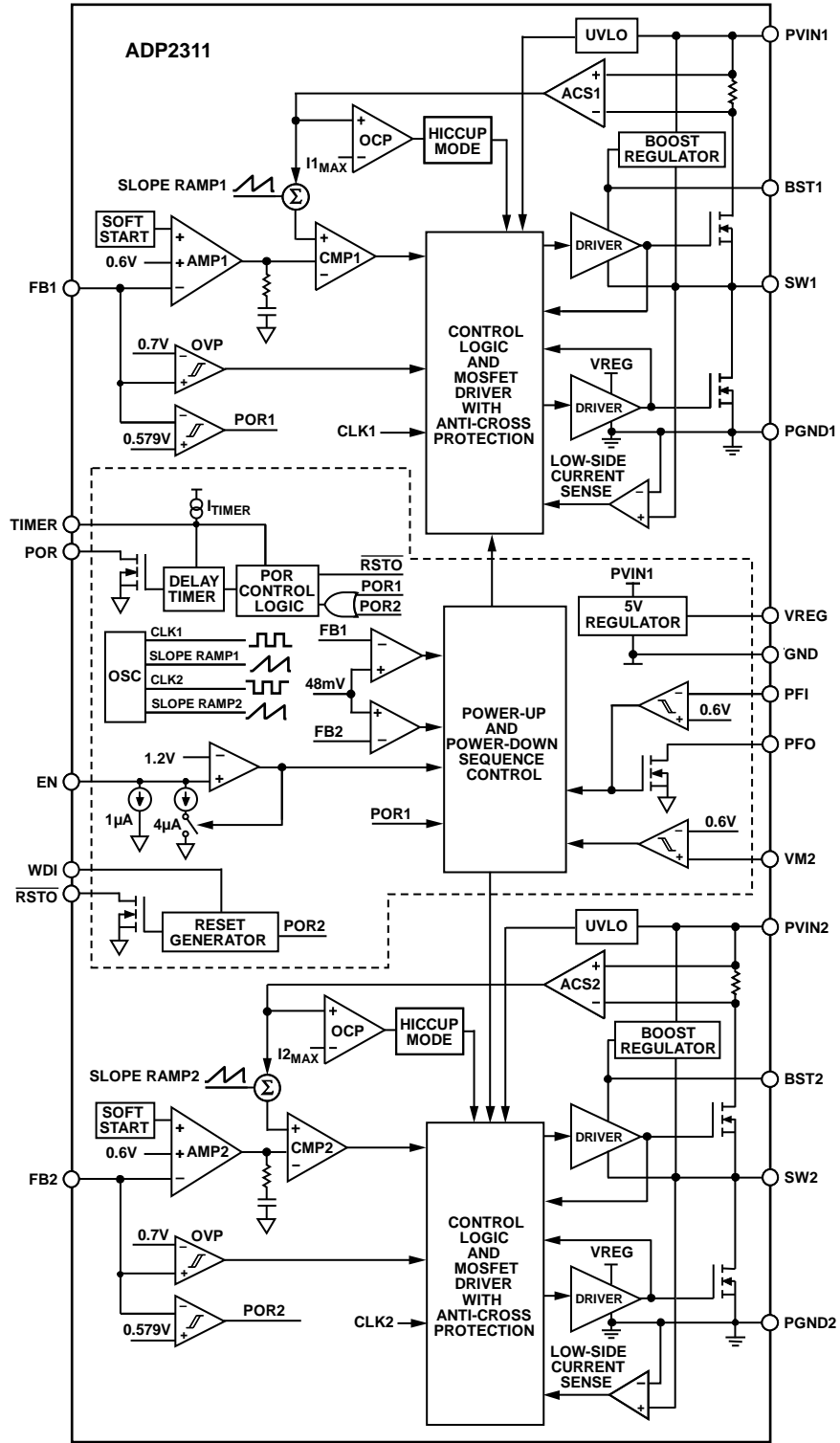

Figure 3.

11036-003

SPECIFICATIONS

PVIN1 = PVIN2 = 12 V, $T_J = -40^\circ\text{C}$ to $+125^\circ\text{C}$, unless otherwise noted.

Table 1.

Parameter	Symbol	Test Conditions/Comments	Min	Typ	Max	Unit
POWER INPUT						
Power Input Voltage Range	V_{PVIN}	PVIN1, PVIN2 pins	4.5		18	V
Quiescent Current (PVIN1 + PVIN2)	I_Q	No switching, FB1 = FB2 = 0.65 V		1.2	1.5	mA
Shutdown Current (PVIN1 + PVIN2)	I_{SHDN}	EN = GND		10	20	μA
PVINx Undervoltage Lockout Threshold				4.2	4.5	V
PVINx Rising			3.5	3.7		V
PVINx Falling						V
FEEDBACK						
FBx Regulation Voltage	V_{FB}	FB1, FB2 pins $T_J = 0^\circ\text{C}$ to $+85^\circ\text{C}$ $T_J = -40^\circ\text{C}$ to $+125^\circ\text{C}$	0.594	0.6	0.606	V
FBx Bias Current	I_{FB}		0.591	0.6	0.609	V
				0.01	0.1	μA
INTERNAL REGULATOR						
VREG Voltage		VREG pin	4.7	5	5.3	V
Dropout Voltage		$I_{VREG} = 5\text{ mA}$		300		mV
Regulator Current Limit			30	50	70	mA
MOSFET ON RESISTANCE						
High-Side On Resistance	$R_{DS(on)}$	Pin to pin measurements V_{BST} to $V_{SW} = 5\text{ V}$		110	158	$\text{m}\Omega$
Low-Side On Resistance		VREG = 5 V		60	90	$\text{m}\Omega$
CURRENT LIMIT						
High-Side Peak Current Limit			1.6	2	2.4	A
Low-Side Source Current Limit			1.9	2.6	3.1	A
Low-Side Sink Current Limit			0.5	1		A
Hiccup Time				4096		Cycles
SWITCH NODE						
SWx Minimum On Time	t_{MIN_ON}	SW1, SW2 pins $I_{SW} = 0.5\text{ A}$		100		ns
SWx Minimum Off Time	t_{MIN_OFF}			165		ns
PWM SWITCHING FREQUENCY						
	f_{SW}		250	300	350	kHz
SOFT START TIME						
	t_{SS}			512		Cycles
ENABLE						
EN Rising Threshold		EN pin		1.2	1.28	V
EN Falling Threshold			1.02	1.1		V
EN Source Current		EN voltage below falling threshold		5		μA
		EN voltage above rising threshold		1		μA
POWER-ON RESET						
Power-On Reset Threshold		POR pin	93.5	95	96.5	%
Power-On Reset Hysteresis		Falling threshold (V_{FB1} and V_{FB2})		1.5		%
Power-On Reset Default Deglitch Time				1.7		ms
POR Leakage Current		$V_{POR} = 5\text{ V}$		0.1	1	μA
POR Output Low Voltage		$I_{POR} = 1\text{ mA}$		65	90	mV
POWER FAIL INPUT AND OUTPUT						
Power Fail Input Threshold	V_{PFI}	PFI and PFO pins	0.591	0.6	0.609	V
Power Fail Input Hysteresis	V_{PFI_HYST}	Rising threshold		25	33	mV
Power Fail Deglitch Time				8		Cycles
PFI Leakage Current		$V_{PFI} = 1.2\text{ V}$		10	50	nA
PFO Leakage Current		$V_{PFO} = 5\text{ V}$		0.1	1	μA
PFO Output Low Voltage		$I_{PFO} = 1\text{ mA}$		65	90	mV

Parameter	Symbol	Test Conditions/Comments	Min	Typ	Max	Unit
VOLTAGE MONITOR COMPARATOR		VM2 pin				
VM2 Input Threshold		Falling threshold	0.585	0.6	0.615	V
VM2 Input Hysteresis				50	65	mV
VM2 Leakage Current				10	50	nA
POR TIMER		TIMER pin				
TIMER Pin Pull-Up Current				3		μA
WATCHDOG		WDI and RSTO pins				
Reset Threshold Voltage		Senses V_{FB2}	93.5	95	96.5	%
Reset Threshold Hysteresis				1.5		%
Reset Timeout Period	t_{RP}		0.883	1	1.17	ms
Watchdog Timeout Period	t_{WD}	See the Ordering Guide				
Option 1			83	100	117	ms
Option 2			41	50	58	ms
Option 3			125	150	175	ms
Option 4			167	200	233	ms
WDI Pulse Width			80			ns
WDI Input High Voltage			1.2			V
WDI Input Low Voltage					0.4	V
RSTO Output Low Voltage		$I_{RSTO} = 1 \text{ mA}$		65	90	mV
RSTO Leakage Current		$V_{RSTO} = 5 \text{ V}$		0.1	1	μA
THERMAL						
Thermal Shutdown Threshold				150		°C
Thermal Shutdown Hysteresis				15		°C

ABSOLUTE MAXIMUM RATINGS

Table 2.

Parameter	Rating
PVIN1, PVIN2, EN	-0.3 V to +20 V
SW1, SW2	-1 V to +20 V
BST1, BST2	$V_{SW} + 6$ V
FB1, FB2, WDI, \overline{RSTO} , VM2, TIMER, POR, PFO, PFI	-0.3 V to +6 V
VREG	-0.3 V to +6 V
PGNDx to GND	-0.3 V to +0.3 V
Operating Temperature Range (Junction)	-40°C to +125°C
Storage Temperature Range	-65°C to +150°C
Soldering Conditions	JEDEC J-STD-020

Stresses above those listed under Absolute Maximum Ratings may cause permanent damage to the device. This is a stress rating only; functional operation of the device at these or any other conditions above those indicated in the operational section of this specification is not implied. Exposure to absolute maximum rating conditions for extended periods may affect device reliability.

THERMAL RESISTANCE

θ_{JA} is specified for the worst-case conditions, that is, a device soldered in a circuit board for surface-mount packages. θ_{JA} is measured using natural convection on a JEDEC 4-layer board with the exposed pad soldered to the printed circuit board (PCB) and with thermal vias.

Table 3. Thermal Resistance

Package Type	θ_{JA}	θ_{JC}	Unit
24-Lead LFCSP_WQ	36.8	1.64	°C/W

ESD CAUTION



ESD (electrostatic discharge) sensitive device. Charged devices and circuit boards can discharge without detection. Although this product features patented or proprietary protection circuitry, damage may occur on devices subjected to high energy ESD. Therefore, proper ESD precautions should be taken to avoid performance degradation or loss of functionality.

PIN CONFIGURATION AND FUNCTION DESCRIPTIONS

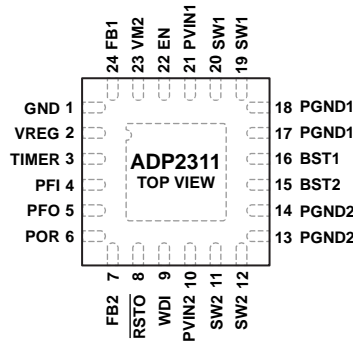

NOTES
1. SOLDER THE EXPOSED PAD TO AN EXTERNAL GND PLANE.

11036-004

Figure 4. Pin Configuration

Table 4. Pin Function Descriptions

Pin No.	Mnemonic	Description
1	GND	Analog Ground. Connect this pin to the ground plane.
2	VREG	Internal 5 V Regulator Output. The IC control circuits are powered from this voltage. Place a 1 μ F ceramic capacitor between VREG and GND.
3	TIMER	POR Sequence Selection and Delay Time Setting. This pin is used to set the POR sequence and delay time (see the TIMER Pin Configuration section).
4	PFI	Power Fail Comparator Input. Connect an external resistor divider from PVIN2 to PFI to monitor the input voltage. When the PFI voltage falls below the threshold voltage, the PFO pin is pulled low.
5	PFO	Power Fail Output (Open Drain).
6	POR	Power-On Reset Output (Open Drain).
7	FB2	Feedback Voltage Sense Input for Channel 2. Connect this pin to a resistor divider from the Channel 2 output voltage, V_{OUT2} .
8	$\overline{\text{RSTO}}$	Watchdog Output (Open Drain). The $\overline{\text{RSTO}}$ pin goes low if the internal watchdog timer times out because of inactivity on the WDI input.
9	WDI	Watchdog Input. If WDI remains high or low for longer than the watchdog timeout period, the watchdog output, $\overline{\text{RSTO}}$, goes low. The timer is reset with each transition at the WDI input; a high to low or low to high transition clears the counter.
10	PVIN2	Power Input for Channel 2. Connect PVIN2 to the input power source, and connect a bypass capacitor between this pin and PGND2.
11, 12	SW2	Switch Node for Channel 2.
13, 14	PGND2	Power Ground for Channel 2.
15	BST2	Supply Rail for the Gate Drive of Channel 2. Place a 0.1 μ F capacitor between SW2 and BST2.
16	BST1	Supply Rail for the Gate Drive of Channel 1. Place a 0.1 μ F capacitor between SW1 and BST1.
17, 18	PGND1	Power Ground for Channel 1.
19, 20	SW1	Switch Node for Channel 1.
21	PVIN1	Power Input for Channel 1. Connect PVIN1 to the input power source, and connect a bypass capacitor between this pin and PGND1.
22	EN	Precision Enable Input. An external resistor divider can be used to set the turn-on threshold. If the enable pin is not used, connect EN to PVINx.
23	VM2	Voltage Monitor Comparator Input. Connect an external resistor divider from PVIN2 to VM2 to monitor the input voltage. During the power-down sequence, Channel 2 turns off when the VM2 voltage falls below the threshold voltage.
24	FB1	Feedback Voltage Sense Input for Channel 1. Connect this pin to a resistor divider from the Channel 1 output voltage, V_{OUT1} .
	EP	Exposed Pad. Solder the exposed pad to an external GND plane.

TYPICAL PERFORMANCE CHARACTERISTICS

$T_A = 25^\circ\text{C}$, $V_{IN} = 12\text{ V}$, $V_{OUT} = 3.3\text{ V}$, $L = 22\ \mu\text{H}$, $C_{OUT} = 47\ \mu\text{F}/\text{X7R}/6.3\text{ V}$, $f_{\text{SW}} = 300\text{ kHz}$, unless otherwise noted.

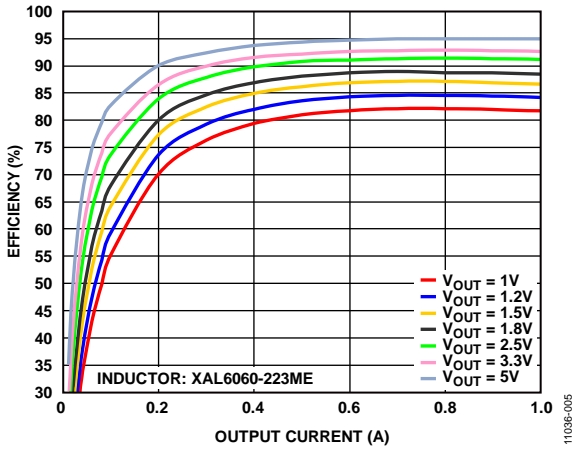

Figure 5. Efficiency vs. Output Current at $V_{IN} = 12\text{ V}$

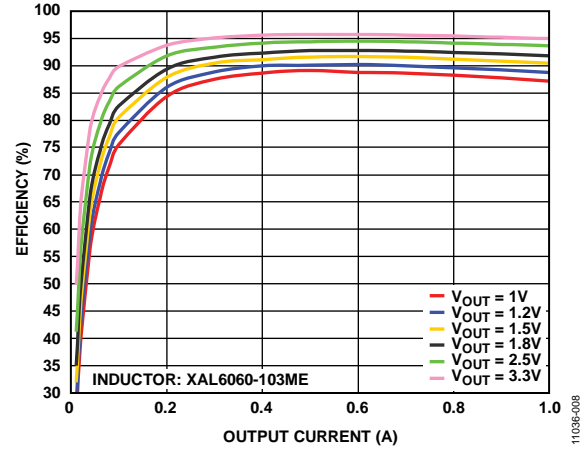

Figure 8. Efficiency vs. Output Current at $V_{IN} = 5\text{ V}$

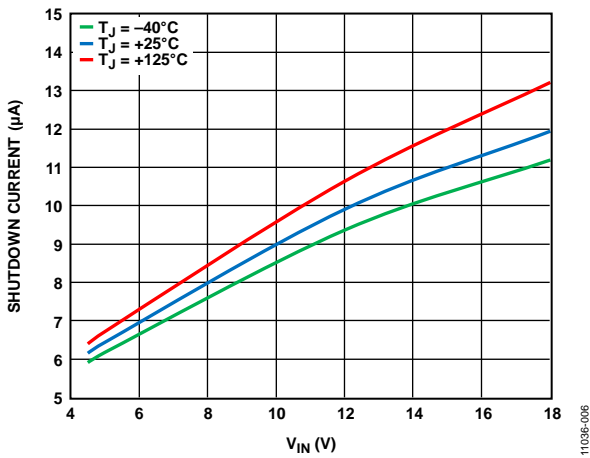

Figure 6. Shutdown Current vs. V_{IN}

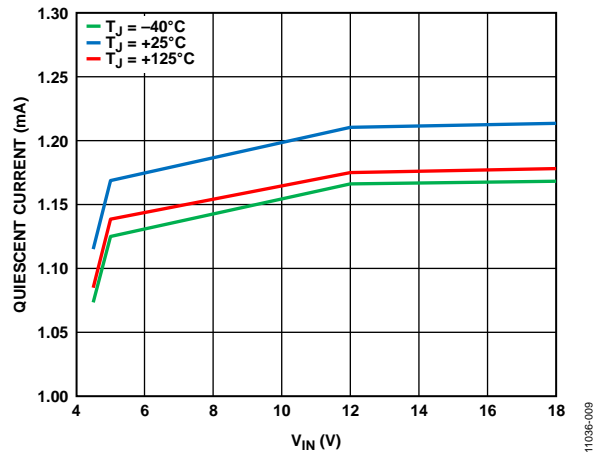

Figure 9. Quiescent Current vs. V_{IN}

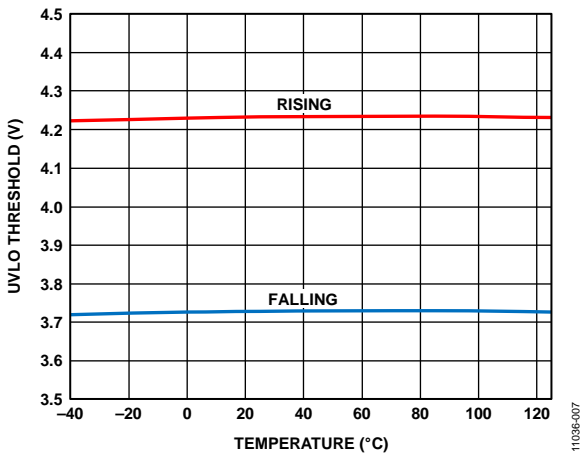

Figure 7. UVLO Threshold vs. Temperature

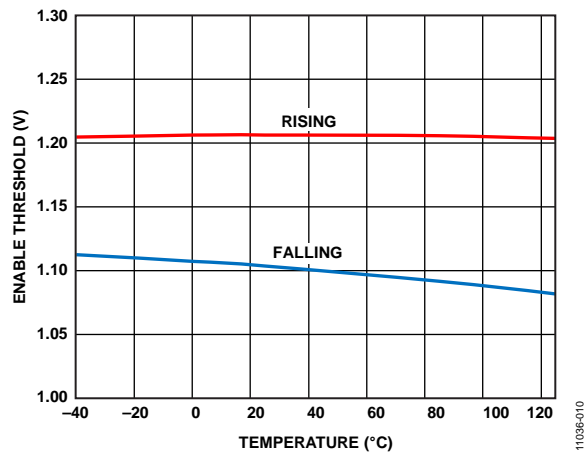

Figure 10. Enable Threshold vs. Temperature

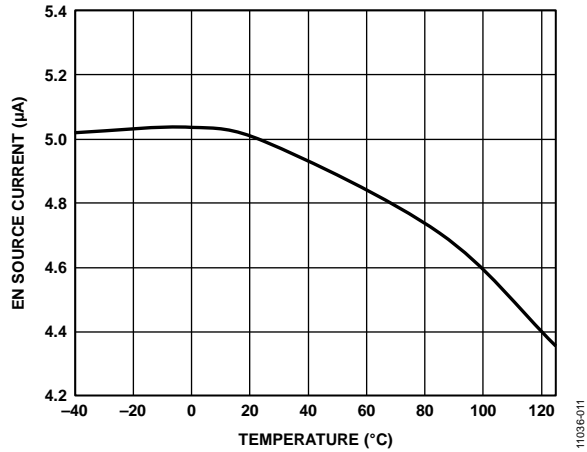

Figure 11. EN Source Current vs. Temperature at $V_{EN} = 1\text{ V}$

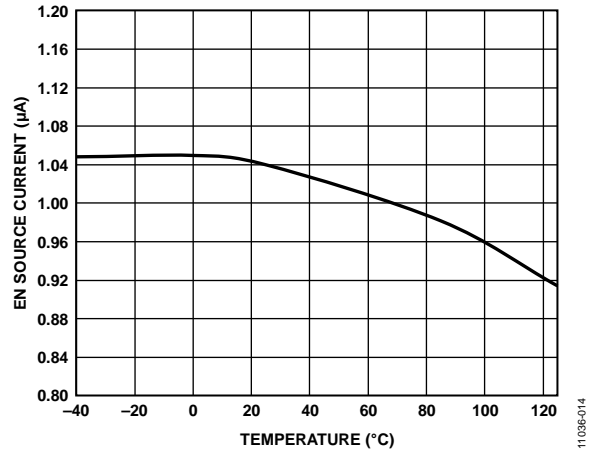

Figure 14. EN Source Current vs. Temperature at $V_{EN} = 1.5\text{ V}$

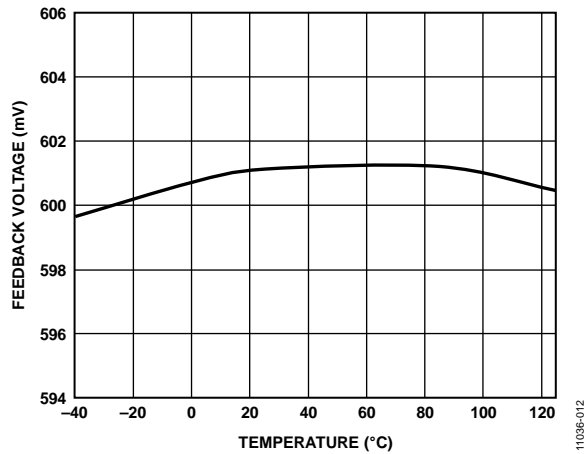

Figure 12. Feedback Voltage vs. Temperature

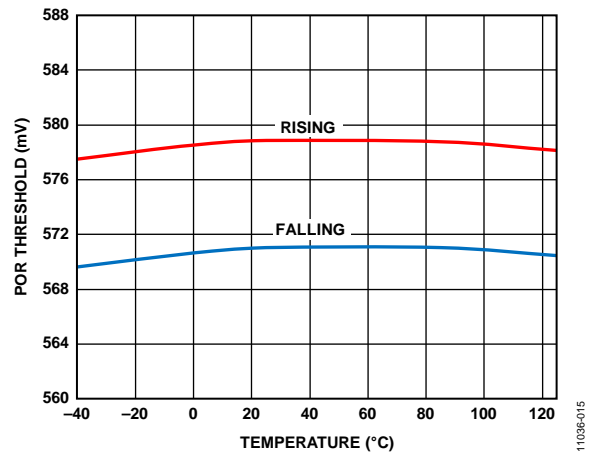

Figure 15. POR Threshold vs. Temperature

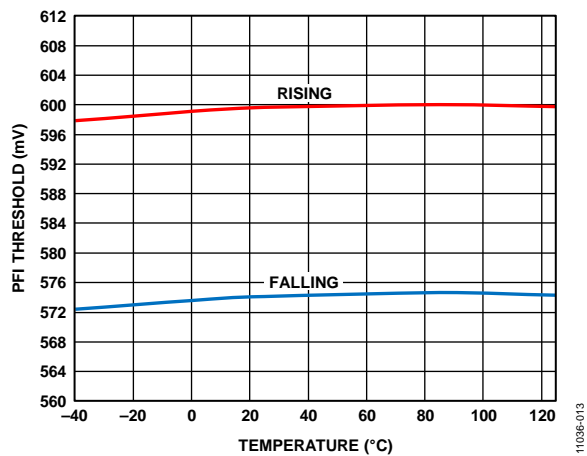

Figure 13. PFI Threshold vs. Temperature

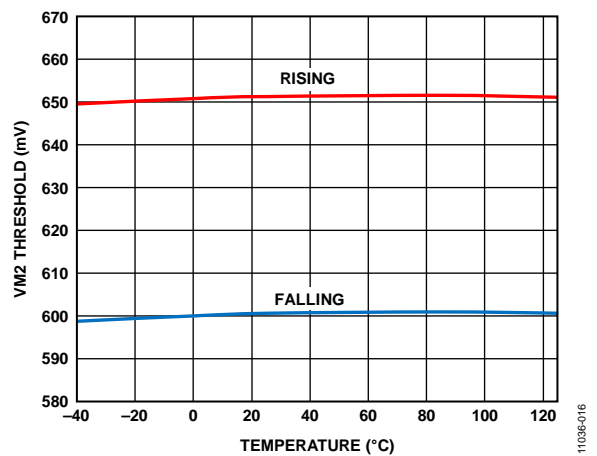

Figure 16. VM2 Threshold vs. Temperature

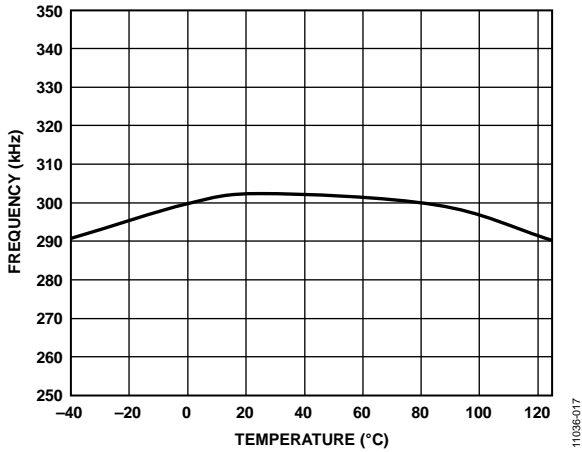

Figure 17. Frequency vs. Temperature

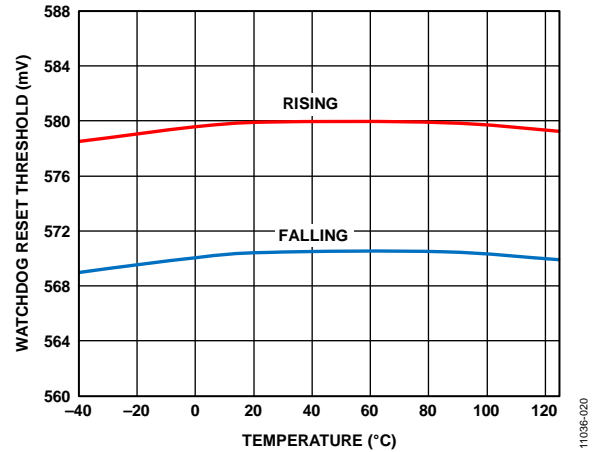

Figure 20. Watchdog Reset Threshold vs. Temperature

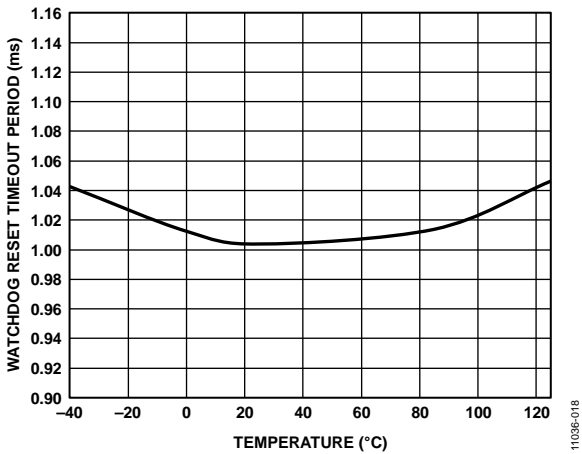

Figure 18. Watchdog Reset Timeout Period vs. Temperature

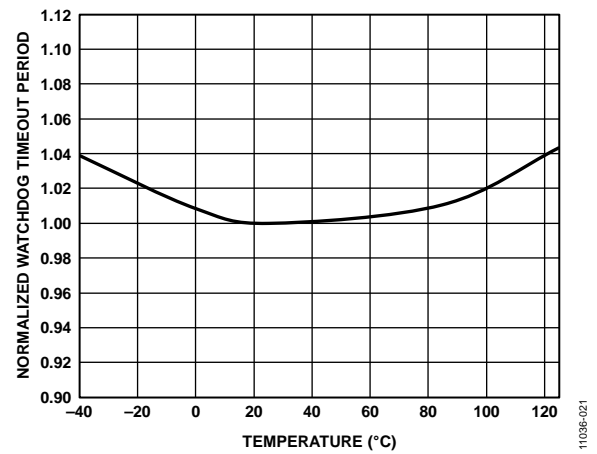

Figure 21. Normalized Watchdog Timeout Period vs. Temperature

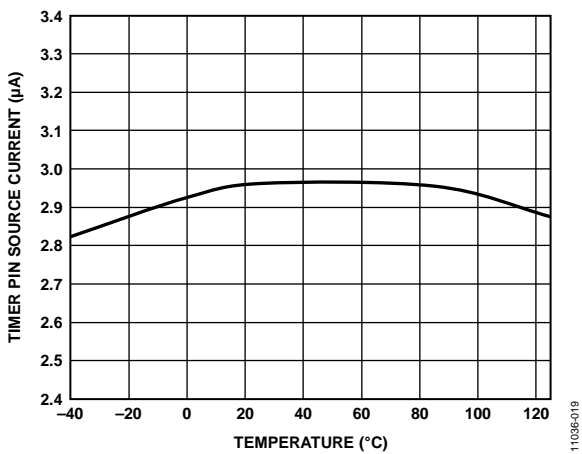

Figure 19. TIMER Pin Source Current vs. Temperature

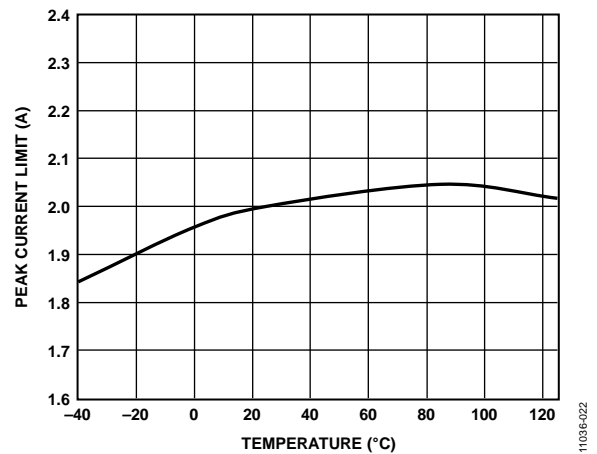

Figure 22. Peak Current Limit Threshold vs. Temperature

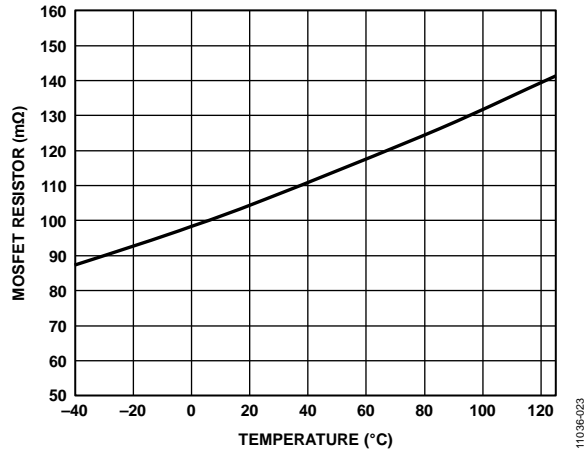

Figure 23. High-Side MOSFET $R_{DS(on)}$ vs. Temperature

11038-023

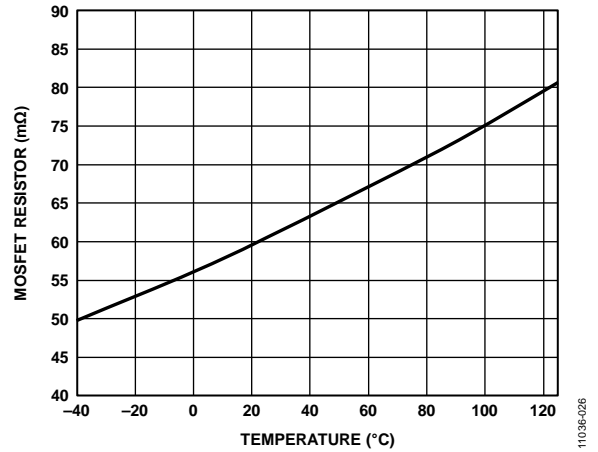

Figure 26. Low-Side MOSFET $R_{DS(on)}$ vs. Temperature

11038-026

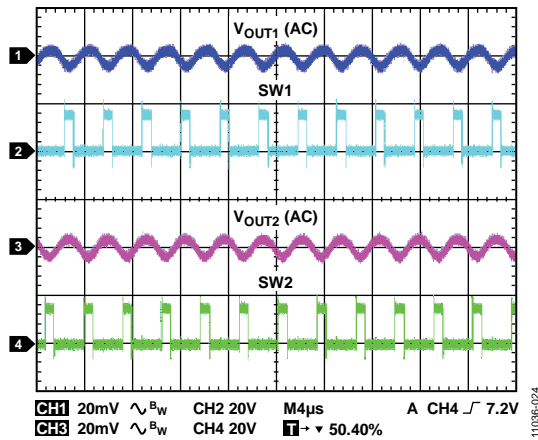

Figure 24. Working Mode Waveform

11038-024

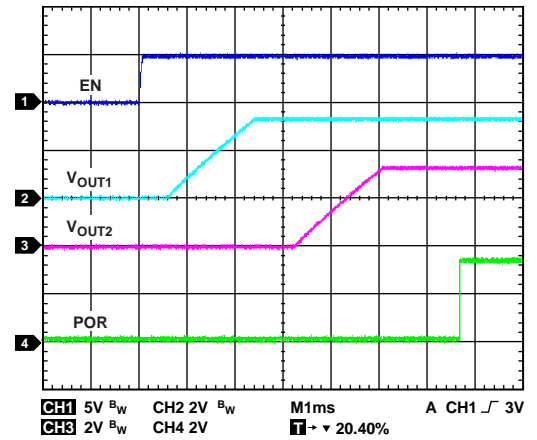

Figure 27. Soft Start with Full Load

11038-027

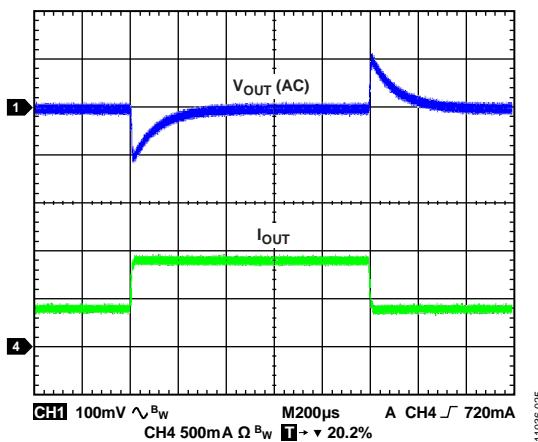

Figure 25. Load Transient Response, 0.25 A to 0.75 A

11038-025

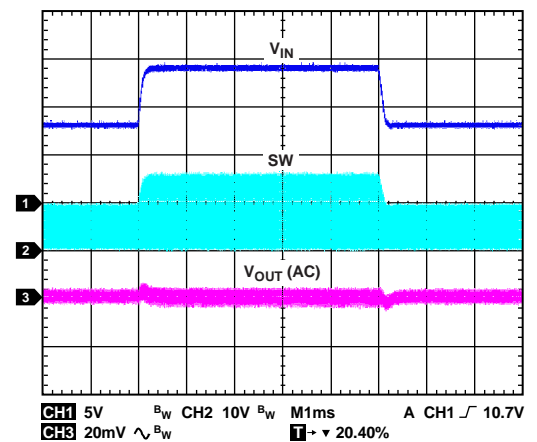

Figure 28. Line Transient Response, V_{IN} from 8 V to 14 V, $I_{OUT} = 1$ A

11038-028

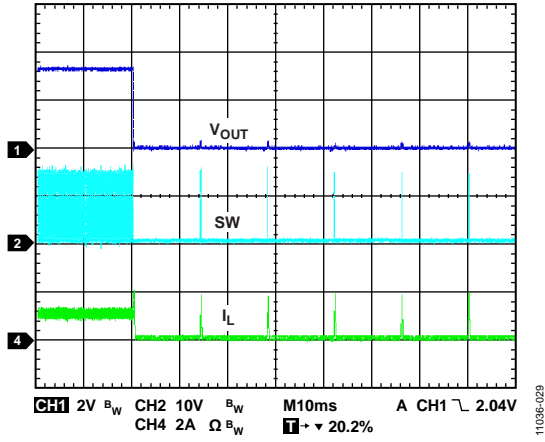

Figure 29. Output Short

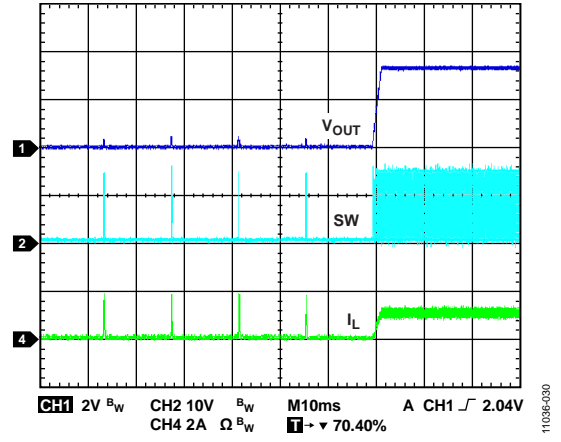

Figure 30. Output Short Recovery

THEORY OF OPERATION

The ADP2311 is a fully integrated, dual output, step-down dc-to-dc regulator. The ADP2311 can operate with an input voltage from 4.5 V to 18 V and can regulate the output voltage down to 0.6 V. The ADP2311 also integrates power-up and power-down sequence circuitry and a watchdog timer to enhance system reliability.

CONTROL SCHEME

The ADP2311 features a fixed frequency, current mode pulse-width modulation (PWM) control architecture. At the start of each oscillator cycle, the high-side MOSFET turns on, placing a positive voltage across the inductor. The inductor current increases until the current sense signal crosses the peak inductor current threshold, which turns off the high-side MOSFET and turns on the low-side MOSFET. This places a negative voltage across the inductor, reducing the inductor current. The low-side MOSFET stays on for the remainder of the cycle.

PRECISION ENABLE/SHUTDOWN

The ADP2311 has a precision enable pin for both channels. The EN pin has an internal pull-down current source of 5 μ A that provides a default turn-off when the EN pin is open.

When the voltage on the EN pin exceeds 1.2 V typical, Channel 1 and Channel 2 are enabled, and the internal pull-down current source at the EN pin is reduced to 1 μ A, which allows the user to program the input voltage UVLO.

When the voltage on the EN pin falls below 1.1 V typical, Channel 1, Channel 2, and all internal circuits are turned off, and the device enters shutdown mode.

INTERNAL REGULATOR (VREG)

The internal regulator provides a stable voltage supply for the internal control circuits and bias voltage for the low-side gate drivers. It is recommended that a 1 μ F ceramic capacitor be placed between VREG and GND. The internal regulator also includes a current-limit circuit for protection.

The PVIN1 pin provides the power supply for the internal regulator shared by both channels.

BOOTSTRAP CIRCUITRY

The ADP2311 integrates boot regulators to provide the gate drive voltage for the high-side MOSFETs. The regulators generate 5 V bootstrap voltages between the BSTx pin and the SWx pin.

It is recommended that an X7R or X5R, 0.1 μ F ceramic capacitor be placed between the BSTx and the SWx pins.

SOFT START

The ADP2311 has integrated soft start circuitry to limit the output voltage rise time and to reduce inrush current at startup. The soft start time is fixed at 512 clock cycles (1.7 ms).

PEAK CURRENT-LIMIT AND SHORT-CIRCUIT PROTECTION

The ADP2311 has a peak current-limit protection circuit to prevent current runaway. The high-side MOSFET peak current is limited to 2 A typical. When the peak inductor current reaches the current-limit threshold, the high-side MOSFET turns off, the low-side MOSFET turns on, and the overcurrent counter increments.

When the low-side MOSFET is turned on, the internal circuit continues to monitor the current going through the low-side MOSFET. At the end of every clock cycle, if the low-side MOSFET source current is greater than the low-side source current limit threshold (2.6 A typical), the high-side MOSFET stays off, the low-side MOSFET stays on for the next cycle, and the overcurrent counter increments. The high-side MOSFET turns on again when the low-side source current is below the low-side source current limit at the start of a cycle.

If the high-side MOSFET peak current does not exceed the peak current limit in one cycle, the overcurrent counter is reset. If the overcurrent counter reaches 10, the device enters hiccup mode. During hiccup mode, the high-side and low-side MOSFETs are both turned off. The device remains in hiccup mode for 4096 clock cycles and then attempts a soft start. If the current-limit fault is cleared, the device resumes normal operation; if the current-limit fault is still active, the device reenters hiccup mode.

The low-side MOSFET can also sink current from the load. If the low-side sink current limit is exceeded, both the low-side and high-side MOSFETs are turned off until the next cycle starts.

POWER-ON RESET (POR)

The POR pin is an active high, open-drain output that requires a resistor to pull it up to a voltage.

The POR threshold is referenced to the FBx pin voltage (V_{FB}) and is specified as a percentage of V_{FB} . The POR falling threshold is 95% typical, 93.5% minimum, and 96.5% maximum, which covers the full temperature range. Therefore, the typical POR falling threshold is 95% of the typical V_{FB} value, the minimum POR falling threshold is 93.5% of the minimum V_{FB} value, and the maximum POR falling threshold is 96.5% of the maximum V_{FB} value.

If V_{FB} is at the minimum value of 0.591 V, the minimum voltage of the POR falling threshold is $0.591 \text{ V} \times 93.5\% = 0.553 \text{ V}$.

If V_{FB} is at the maximum value of 0.609 V, the maximum voltage of the POR falling threshold is $0.609 \text{ V} \times 96.5\% = 0.588 \text{ V}$.

Therefore, the worst-case POR falling threshold voltage range is 0.553 V to 0.588 V.

The typical POR falling threshold voltage is $0.6 \text{ V} \times 95\% = 0.57 \text{ V}$.

The POR function has hysteresis of 1.5% between the falling and rising thresholds. The POR rising threshold is 96.5% typical, 95% minimum, and 98% maximum. Therefore, the typical POR rising trigger voltage is $0.6\text{ V} \times 96.5\% = 0.579\text{ V}$. The POR rising threshold voltage is always higher than the POR falling threshold voltage.

TIMER PIN CONFIGURATION

The POR sequence timing and delay time depend on the configuration of the TIMER pin.

Figure 31 shows the first configuration of the TIMER pin.

Figure 34 shows the power-on reset timing for this configuration. As shown in Figure 31, a capacitor is connected between the TIMER pin and GND. The POR pin is pulled high when both V_{OUT1} and V_{OUT2} are above 96.5% of the V_{OUTX} nominal value after a delay time. The POR pin is pulled low when either V_{OUT1} or V_{OUT2} falls below 95% of the V_{OUTX} nominal voltage.

The POR delay time is determined by the maximum value between the internal default delay of 1.7 ms and an external delay time calculated by the following equation:

$$t_{DELAY} = \frac{0.6\text{ V} \times C_{TIMER}}{I_{TIMER}}$$

where:

C_{TIMER} is the capacitor between the TIMER pin and GND (1 nF to 68 nF).

I_{TIMER} is the pull-up current of the TIMER pin (3 μA).

Figure 32 shows the second configuration of the TIMER pin.

Figure 35 shows the power-on reset timing for this configuration. As shown in Figure 32, a resistor and capacitor are connected between the TIMER pin and GND. The POR pin is pulled high when both V_{OUT1} and V_{OUT2} are above 96.5% of the V_{OUTX} nominal value after a delay time. The POR pin is pulled low when V_{OUT1} or V_{OUT2} falls below 95% of the V_{OUTX} nominal voltage or when the watchdog timer times out (the $RSTO$ pin is taken from high to low).

The POR delay time is determined by the maximum value between the internal default delay of 1.7 ms and an external delay time calculated by the following equation:

$$t_{DELAY} = \left(0.6\text{ V} - I_{TIMER} \times R_{SEQ}\right) \times \frac{C_{TIMER}}{I_{TIMER}}$$

where:

R_{SEQ} is a resistor in the range of 8 k Ω to 12 k Ω . Typically, a 10 k Ω resistor is chosen for R_{SEQ} .

C_{TIMER} is a capacitor in the range of 1 nF to 68 nF.

Figure 33 shows the third configuration of the TIMER pin.

Figure 35 shows the power-on reset timing for this configuration. In this configuration, the TIMER pin is floating. The POR delay time is fixed at 1.7 ms.

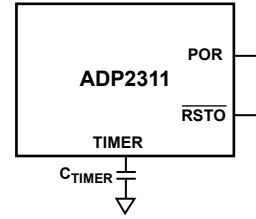

Figure 31. Capacitor Connected Between TIMER and GND

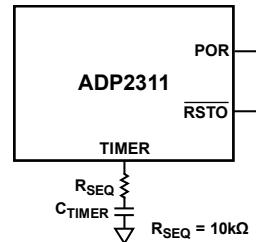

Figure 32. Resistor and Capacitor Connected Between TIMER and GND

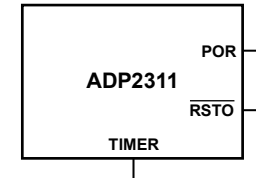

Figure 33. TIMER Pin Floating

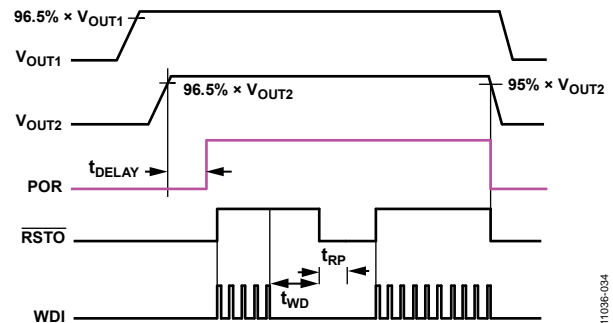

Figure 34. Power-On Reset Timing for Figure 31

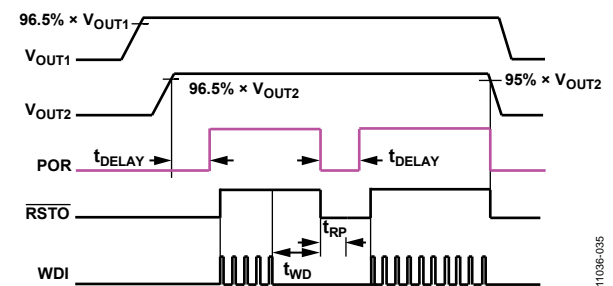

Figure 35. Power-On Reset Timing for Figure 32 and Figure 33

POWER FAIL COMPARATOR

The ADP2311 integrates a power fail comparator that can generate a warning when the input voltage falls below the designated voltage. When the PFI input voltage falls below 0.575 V, the PFO pin is pulled low. When the PFI input voltage rises above 0.6 V, the PFO pin is pulled high. The low leakage current of the PFI pin allows the use of a large value external resistor to reduce system current consumption.

The PFO pin can be used to send a warning signal to the processor in case of an abnormal input voltage condition so that the processor can prepare to power down the system before power is lost.

VOLTAGE MONITOR COMPARATOR (VM2)

The VM2 pin connects to an accurate comparator. When the VM2 voltage falls below 0.6 V, Channel 2 is turned off. When the VM2 voltage rises above 0.65 V, Channel 2 is allowed to power up if the EN pin is high and PFI is above 0.6 V.

WATCHDOG TIMER

The watchdog timer circuit is used to monitor the activity of the processor. During power-up, the watchdog timer circuit does not acknowledge pulses from the WDI pin until the voltage at FB2 is above the reset threshold and the reset timeout period (t_{RP}) has elapsed. During the power-up sequence, the \overline{RSTO} pin is pulled low and remains low until the watchdog timer circuit is activated. The watchdog timer circuit can be initialized only by a low to high transition on the WDI pin both after power up and after a watchdog timeout (see Figure 36).

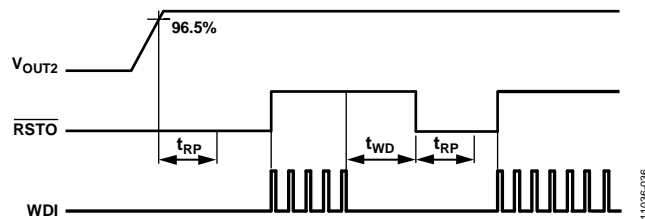

Figure 36. Watchdog Timing Diagram

After the watchdog timer circuit is active, it is cleared with every low to high or high to low logic transition on the WDI pin, which can detect pulse widths as short as 80 ns. If the WDI pin remains high or low for longer than the watchdog timeout period (t_{WD}), a reset is asserted, and the \overline{RSTO} pin is pulled low. The processor is required to toggle the WDI pin within the timeout period; therefore, it indicates a code execution error, and the generated reset pulse (t_{RP}) restarts the microprocessor in a known state.

The watchdog timer can also be cleared by a reset assertion due to an undervoltage condition on V_{OUT2} . When the FB2 voltage is below the reset threshold, a reset is asserted; the watchdog timer is cleared and does not begin counting again until reset is deasserted.

The watchdog timeout (t_{WD}) is set by the factory to one of four possible values: 50 ms, 100 ms, 150 ms, and 200 ms (see the Ordering Guide).

POWER-UP AND POWER-DOWN SEQUENCE

The ADP2311 has a controlled power-up and power-down sequence. During power-up, Channel 1 is powered up before Channel 2. During power-down, Channel 2 is powered down before Channel 1.

Channel 1 does not power up until all of the following conditions are met followed by a 128 cycle delay:

- The PFI voltage exceeds 0.6 V.
- The voltage on the EN pin exceeds 1.2 V.
- Both the FB1 and FB2 voltages are less than 48 mV.

When V_{OUT1} reaches 96.5% of its normal voltage, Channel 2 is powered up after a delay of 256 cycles.

During power-down, when the VM2 voltage falls below 0.6 V, Channel 2 is turned off and power feedback occurs. Channel 2 energy is fed back to the input voltage to speed up the discharge time of Channel 2. When the FB2 output voltage falls below 48 mV, Channel 1 is allowed to turn off, and power feedback occurs to speed up the discharge time of Channel 1.

The power feedback feature allows the Channel 1 and Channel 2 output voltage fall time (100% to 10%) to be within 10 ms.

OVERVOLTAGE PROTECTION (OVP)

The ADP2311 provides an OVP feature to protect the system against output shorts to a higher voltage supply or when a strong load disconnect transient occurs.

If the feedback voltage increases to 0.7 V, the high-side MOSFET turns off and the low-side MOSFET turns on until the negative current limit threshold is triggered. After the negative current limit threshold is triggered, both MOSFETs are held in the off state until the FBx pin voltage falls to 0.63 V, at which point the ADP2311 resumes normal operation.

UNDERVOLTAGE LOCKOUT (UVLO)

The UVLO threshold is 4.2 V with hysteresis of 0.5 V to prevent power-on glitches on the device. When the PVIN1 or PVIN2 voltage rises above 4.2 V, Channel 1 or Channel 2 is enabled, and the soft start period begins. When PVIN1 or PVIN2 falls below 3.7 V, Channel 1 or Channel 2 is turned off.

THERMAL SHUTDOWN

If the ADP2311 junction temperature exceeds 150°C, the PFO pin is immediately pulled low, and Channel 2 enters power feedback mode. When V_{OUT2} falls below 95% of its nominal voltage, the POR and RSTO pins are pulled low. When the FB2 voltage falls below 48 mV, Channel 1 turns off and enters discharge mode.

A 15°C hysteresis is included so that the ADP2311 does not recover from thermal shutdown until the on-chip temperature falls below 135°C. Upon recovery, a soft start is initiated before normal operation. Figure 37 shows the power sequence during thermal protection based on the circuit shown in Figure 38.

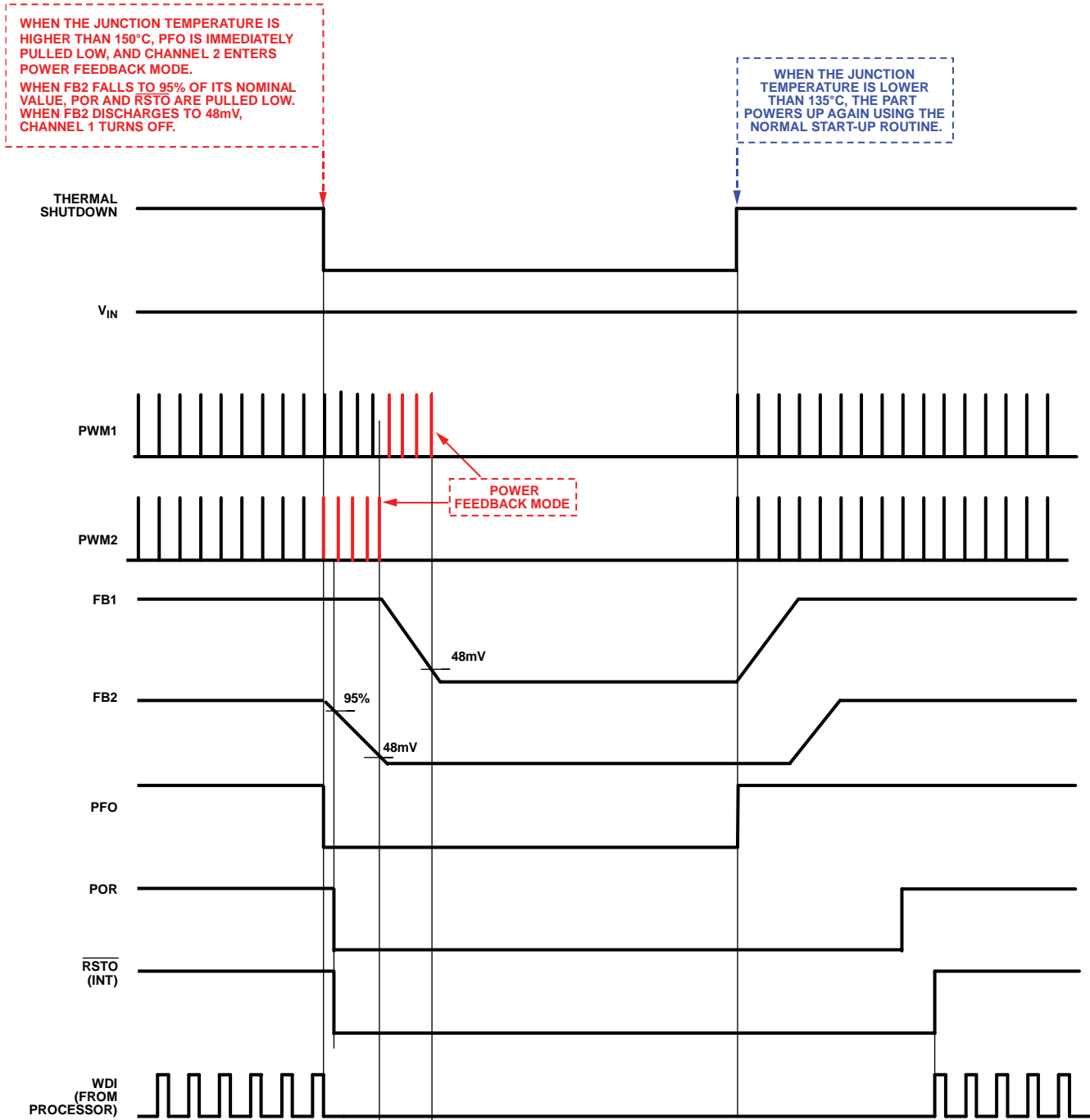

Figure 37. Power Sequence During Thermal Protection Based on the Circuit Shown in Figure 38

11039-037

APPLICATIONS INFORMATION

INPUT CAPACITOR SELECTION

The input capacitor reduces the input voltage ripple caused by the switch current on PVINx. Place the input capacitor as close as possible to the PVINx pin. A ceramic capacitor in the 10 μF to 47 μF range is recommended. The loop composed of the input capacitor, the high-side MOSFET, and the low-side MOSFET must be kept as small as possible.

The voltage rating of the input capacitor must be greater than the maximum input voltage. Ensure that the rms current rating of the input capacitor is larger than the value calculated from the following equation:

$$I_{CIN_RMS} = I_{OUT} \times \sqrt{D \times (1 - D)}$$

where D is the duty cycle ($D = V_{OUT}/V_{IN}$).

OUTPUT VOLTAGE SETTING

The output voltage of the ADP2311 can be set by an external resistor divider using the following equation:

$$V_{OUT} = 0.6 \times \left(1 + \frac{R_{TOP}}{R_{BOT}} \right)$$

To limit the output voltage accuracy degradation due to the FB bias current (0.1 μA maximum) to less than 0.5% (maximum), ensure that $R_{BOT} < 30 \text{ k}\Omega$.

Table 5 lists the recommended resistor divider values for various output voltages.

Table 5. Resistor Divider Values for Various Output Voltages

V _{OUT} (V)	R _{TOP} \pm 1% (k Ω)	R _{BOT} \pm 1% (k Ω)
1.0	10	15
1.2	10	10
1.5	15	10
1.8	20	10
2.5	47.5	15
3.3	10	2.21
5.0	22	3

INDUCTOR SELECTION

The inductor value is determined by the operating frequency, input voltage, output voltage, and inductor ripple current. Using a small inductor value leads to a faster transient response, but degrades efficiency due to a larger inductor ripple current. Using a large inductor value leads to smaller ripple current and better efficiency, but results in a slower transient response.

As a guideline, the inductor ripple current, ΔI_L , is typically set to one-third of the maximum load current. The inductor value is calculated using the following equation:

$$L = \frac{(V_{IN} - V_{OUT}) \times D}{\Delta I_L \times f_{SW}}$$

where:

V_{IN} is the input voltage.

V_{OUT} is the output voltage.

D is the duty cycle ($D = V_{OUT}/V_{IN}$).

ΔI_L is the inductor current ripple.

f_{SW} is the switching frequency.

The peak inductor current is calculated by

$$I_{PEAK} = I_{OUT} + \frac{\Delta I_L}{2}$$

The saturation current of the inductor must be larger than the peak inductor current. For ferrite core inductors with a quick saturation characteristic, the saturation current rating of the inductor must be higher than the current-limit threshold of the switch to prevent the inductor from reaching saturation.

The rms current of the inductor is calculated using the following equation:

$$I_{RMS} = \sqrt{I_{OUT}^2 + \frac{\Delta I_L^2}{12}}$$

Shielded ferrite core materials are recommended for low core loss and low EMI. Table 6 lists some recommended inductors.

Table 6. Recommended Inductors

Vendor	Part No.	Value (μH)	I _{SAT} (A)	I _{RMS} (A)	DCR (m Ω)
Sumida	CDRH8D58/LDNP-100NC	10	2.2	4.5	20.5
	CDRH8D58/LDNP-150NC	15	1.9	3.6	29
	CDRH8D58/LDNP-220NC	22	1.4	3.3	36.2
Coilcraft	XAL6060-103ME	10	7.6	7	27
	XAL6060-153ME	15	5.8	6	39.7
	XAL6060-223ME	22	5.6	5	55.1

OUTPUT CAPACITOR SELECTION

The output capacitor selection affects both the output voltage ripple and the loop dynamics of the regulator. The ADP2311 is designed to operate with small ceramic capacitors that have low equivalent series resistance (ESR) and low equivalent series inductance (ESL) and can, therefore, easily meet the output voltage ripple specifications.

When the regulator operates in continuous conduction mode, the overall output voltage ripple is the sum of the voltage spike caused by the output capacitor ESR plus the voltage ripple caused by the charging and discharging of the output capacitor.

$$\Delta V_{RIPPLE} = \Delta I_L \times \left(\frac{1}{8 \times f_{SW} \times C_{OUT}} + ESR_{C_{OUT}} \right)$$

Capacitors with lower ESR are preferable to guarantee low output voltage ripple, as shown in the following equation:

$$ESR_{C_{OUT}} \leq \frac{\Delta V_{RIPPLE}}{\Delta I_L}$$

Ceramic capacitors are manufactured with a variety of dielectrics, each with different behavior over temperature and applied voltage. X5R or X7R dielectrics are recommended for best performance due to their low ESR and small temperature coefficients.

Table 7 lists recommended output capacitors for $V_{OUT} \leq 5.0$ V.

Table 7. Recommended Output Capacitors for $V_{OUT} \leq 5.0$ V

Vendor	Part No.	Value
Murata	GRM31CR60J226KE19	22 μ F, 6.3 V, X5R
	GRM32ER60J476ME20	47 μ F, 6.3 V, X5R
TDK	C3216X5R0J226M160AA	22 μ F, 6.3 V, X5R
	C3216X5R0J336M130AC	33 μ F, 6.3 V, X5R
	C3216X5R0J476M160AC	47 μ F, 6.3 V, X5R

Table 8 lists the recommended external inductors and output capacitors for typical applications with the ADP2311.

Table 8. Recommended External Components for Typical Applications

V_{IN} (V)	V_{OUT} (V)	L (μ H)	C_{OUT} (μ F)	R_{TOP} (k Ω), $\pm 1\%$	R_{BOT} (k Ω), $\pm 1\%$
12	1.0	10	2 \times 47	10	15
12	1.2	10	2 \times 47	10	10
12	1.5	15	2 \times 47	15	10
12	1.8	15	47	20	10
12	2.5	22	47	47.5	15
12	3.3	22	22	10	2.21
12	5.0	33	22	22	3
5	1.0	10	2 \times 47	10	15
5	1.2	10	2 \times 47	10	10
5	1.5	10	47	15	10
5	1.8	10	47	20	10
5	2.5	10	22	47.5	15
5	3.3	10	22	10	2.21

APPLICATION CIRCUIT

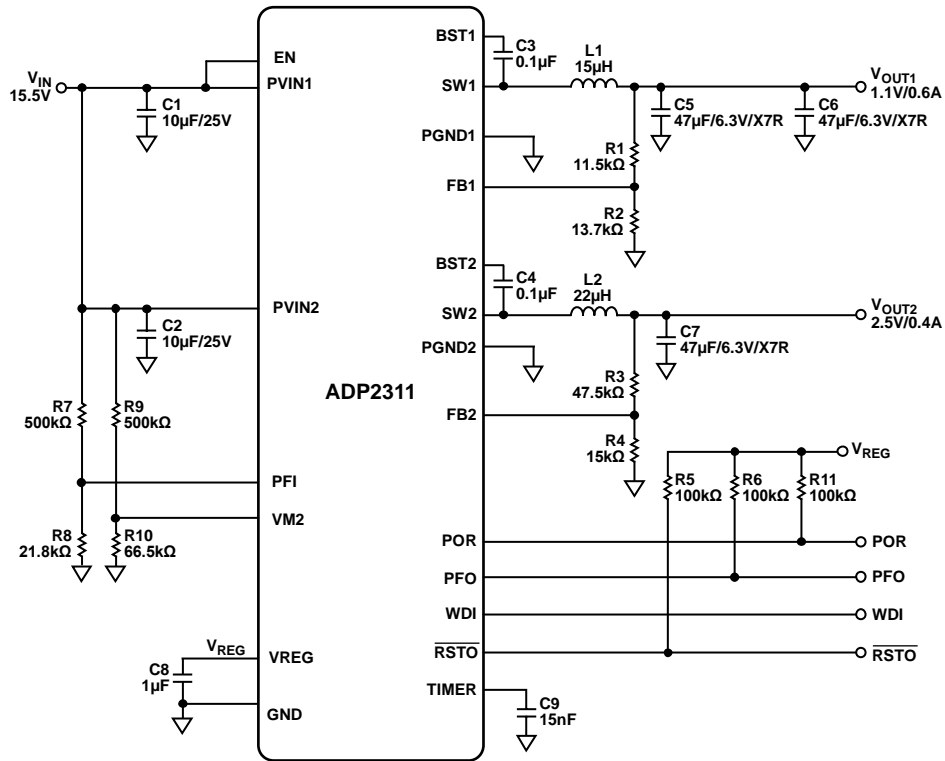

Figure 38. Typical Application Circuit (Input Power Fail Voltage Programmed at 14.4 V/13.8 V; Channel 2 Turned Off at 5.1 V)

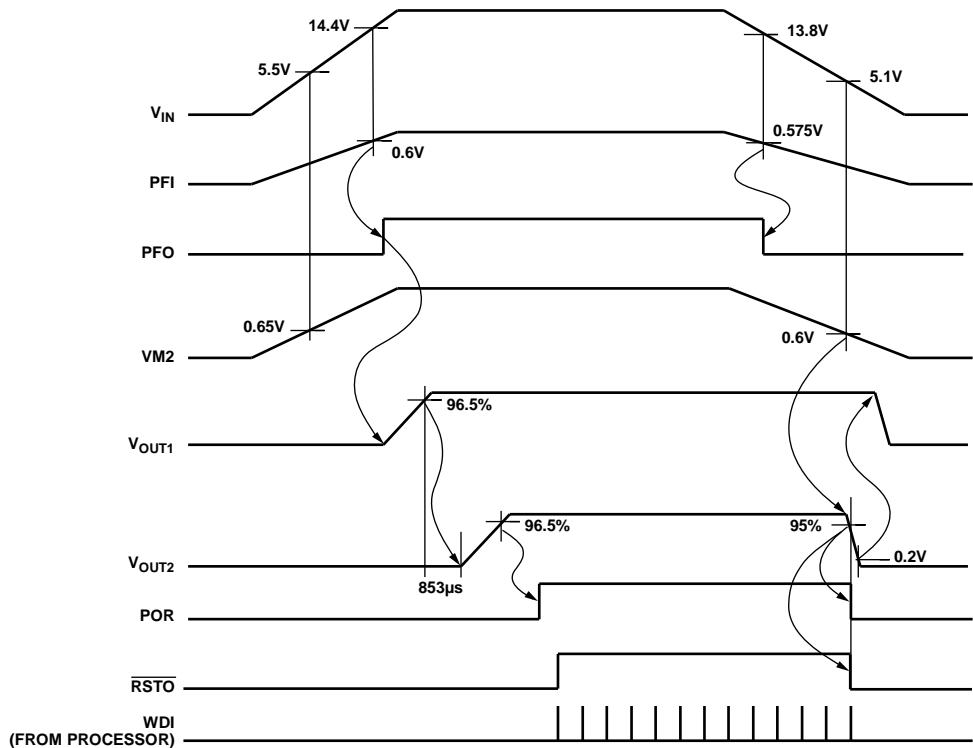
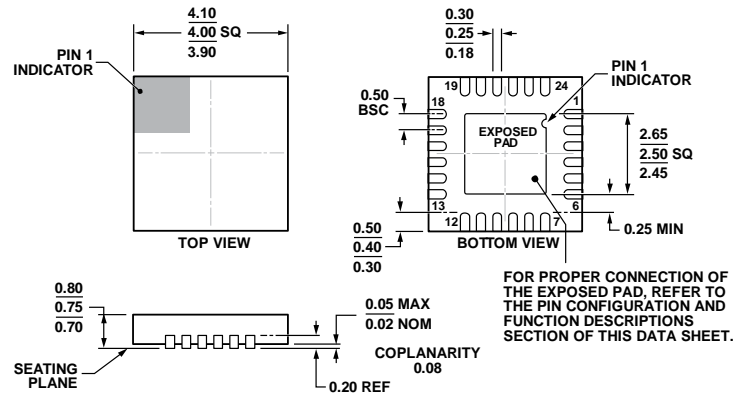

Figure 39. Power-Up and Power-Down Sequence Based on the Circuit Shown in Figure 38

OUTLINE DIMENSIONS



COMPLIANT TO JEDEC STANDARDS MO-220-WGGD.

Figure 40. 24-Lead Lead Frame Chip Scale Package [LFCSP_WQ]
 4 mm × 4 mm Body, Very Very Thin Quad
 (CP-24-7)
 Dimensions shown in millimeters

04132012A

ORDERING GUIDE

Model ¹	Temperature Range	Watchdog Timeout Period	Package Description	Package Option
ADP2311ACPZ-1-R7	-40°C to +125°C	t _{WD} = 100 ms	24-Lead LFCSP_WQ	CP-24-7
ADP2311ACPZ-2-R7	-40°C to +125°C	t _{WD} = 50 ms	24-Lead LFCSP_WQ	CP-24-7
ADP2311ACPZ-3-R7	-40°C to +125°C	t _{WD} = 150 ms	24-Lead LFCSP_WQ	CP-24-7
ADP2311ACPZ-4-R7	-40°C to +125°C	t _{WD} = 200 ms	24-Lead LFCSP_WQ	CP-24-7
ADP2311-1-EVALZ			Evaluation Board	

¹ Z = RoHS Compliant Part.

Mouser Electronics

Authorized Distributor

Click to View Pricing, Inventory, Delivery & Lifecycle Information:

[Analog Devices Inc.:](#)

[ADP2311ACPZ-1-R7](#) [ADP2311-1-EVALZ](#) [ADP2311ACPZ-2-R7](#) [ADP2311ACPZ-3-R7](#) [ADP2311ACPZ-4-R7](#)