

Analog Devices Welcomes Hittite Microwave Corporation

NO CONTENT ON THE ATTACHED DOCUMENT HAS CHANGED



THIS PAGE INTENTIONALLY LEFT BLANK

Typical Applications

The HMC311ST89(E) is ideal for:

- Cellular / PCS / 3G
- Fixed Wireless & WLAN
- CATV & Cable Modem
- Microwave Radio

Features

- P1dB Output Power: +15.5 dBm
- Output IP3: +31.5 dBm
- Gain: 16 dB
- 50 Ohm I/O's
- Industry Standard SOT89 Package
- Included in the HMC-DK001 Designer's Kit

Functional Diagram

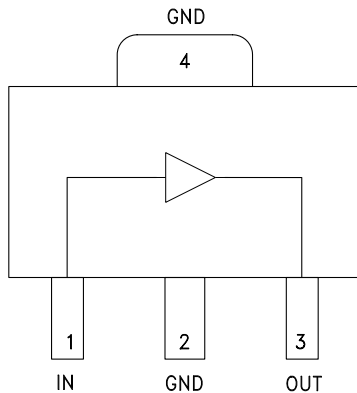

General Description

The HMC311ST89(E) is a GaAs InGaP Heterojunction Bipolar Transistor (HBT) Gain Block MMIC SMT DC to 6 GHz amplifier. Packaged in an industry standard SOT89, the amplifier can be used as either a cascadable 50 Ohm gain stage or to drive the LO of HMC mixers with up to +16.5 dBm output power. The HMC311ST89(E) offers 16 dB of gain and an output IP3 of +31.5 dBm while requiring only 54 mA from a +5V supply. The Darlington feedback pair used results in reduced sensitivity to normal process variations and yields excellent gain stability over temperature while requiring a minimal number of external bias components.

Electrical Specifications, $V_s = 5V$, $R_{bias} = 22\ \Omega$, $T_A = +25^\circ\ C$

Parameter		Min.	Typ.	Max.	Units
Gain	DC - 1.0 GHz	14.0	16.0		dB
	1.0 - 4.0 GHz	13.0	15.0		dB
	4.0 - 6.0 GHz	12.5	14.5		dB
Gain Variation Over Temperature	DC - 2.0 GHz		0.004	0.007	dB/ °C
	2.0 - 4.0 GHz		0.007	0.012	dB/ °C
	4.0 - 6.0 GHz		0.012	0.016	dB/ °C
Return Loss Input / Output	DC - 2.0 GHz		8		dB
	2.0 - 5.0 GHz		7		dB
	5.0 - 6.0 GHz		8		dB
Reverse Isolation	DC - 6 GHz		20		dB
Output Power for 1 dB Compression (P1dB)	DC - 2.0 GHz	13.5	15.5		dBm
	2.0 - 4.0 GHz	12.0	15.0		dBm
	4.0 - 6.0 GHz	10.0	13.0		dBm
Output Third Order Intercept (IP3)	DC - 1.0 GHz		31.5		dBm
	1.0 - 2.0 GHz		30		dBm
	2.0 - 4.0 GHz		27		dBm
	4.0 - 6.0 GHz		24		dBm
Noise Figure	DC - 4 GHz		4.5		dB
	4.0 - 6.0 GHz		5		dB
Supply Current (Icq)			55	74	mA

Note: Data taken with broadband bias tee on device output.

For price, delivery and to place orders: Hittite Microwave Corporation, 20 Alpha Road, Chelmsford, MA 01824

Phone: 978-250-3343 Fax: 978-250-3373 Order On-line at www.hittite.com

Application Support: Phone: 978-250-3343 or apps@hittite.com

Broadband Gain & Return Loss

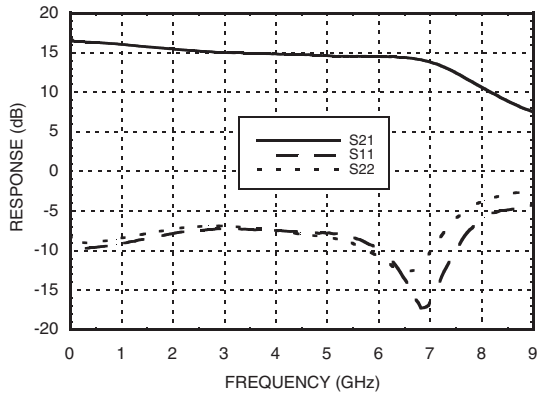

Gain vs. Temperature

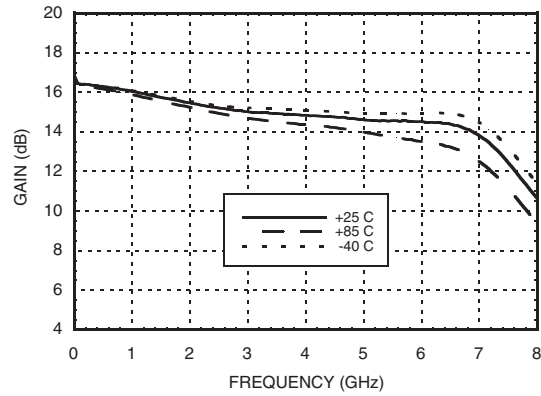

Input Return Loss vs. Temperature

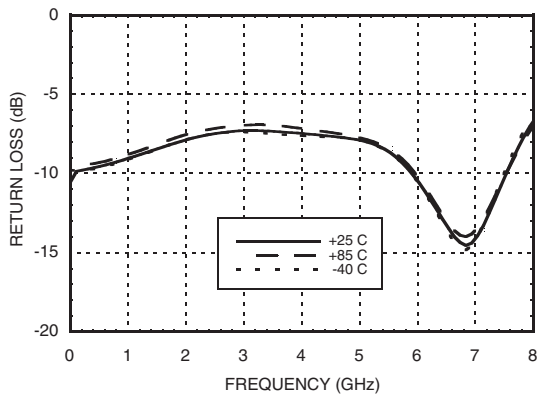

Output Return Loss vs. Temperature

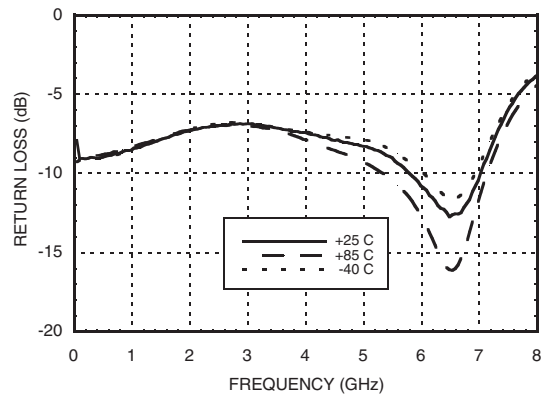

Reverse Isolation vs. Temperature

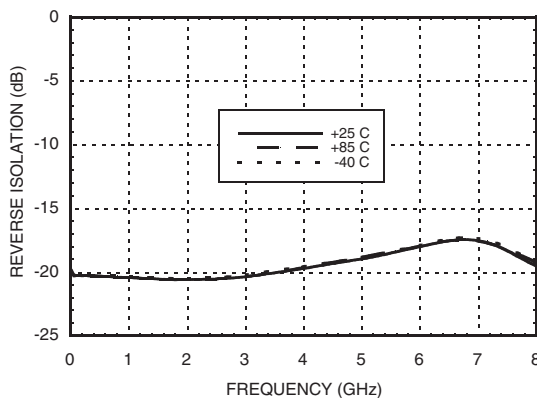

Noise Figure vs. Temperature

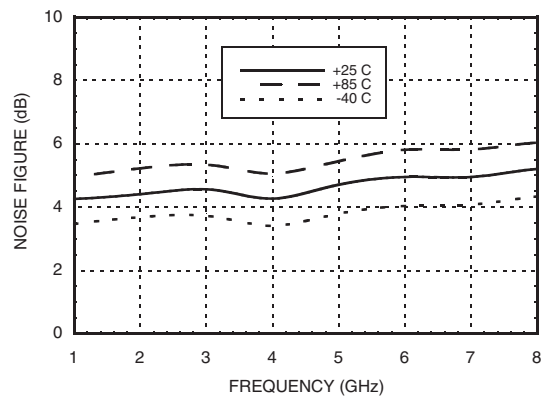

P1dB vs. Temperature

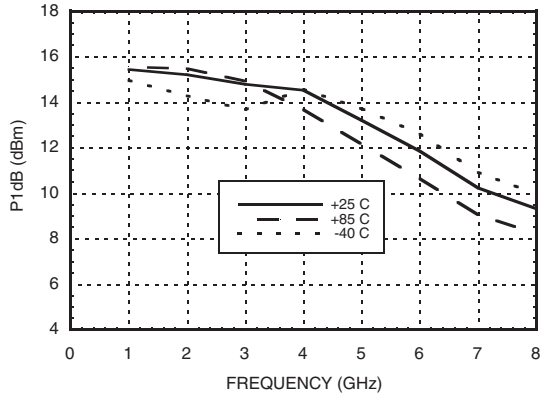

Psat vs. Temperature

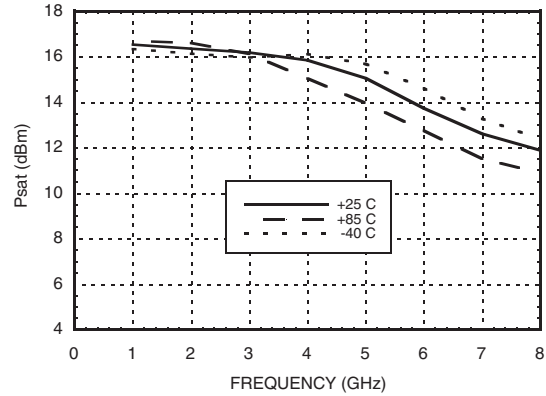

Power Compression @ 1 GHz

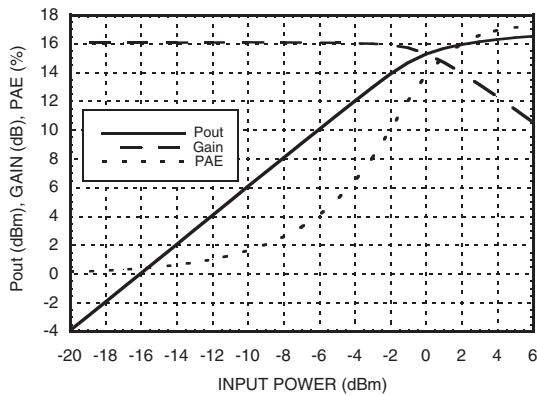

Power Compression @ 6 GHz

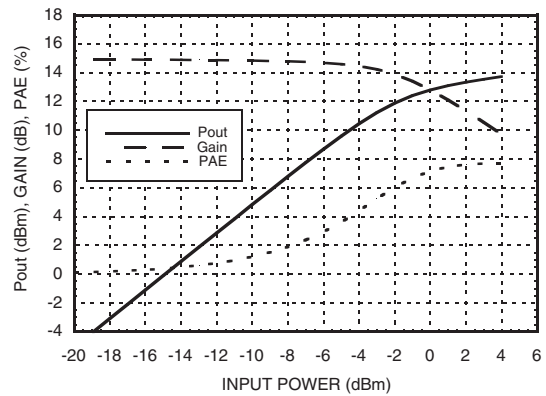

Output IP3 vs. Temperature

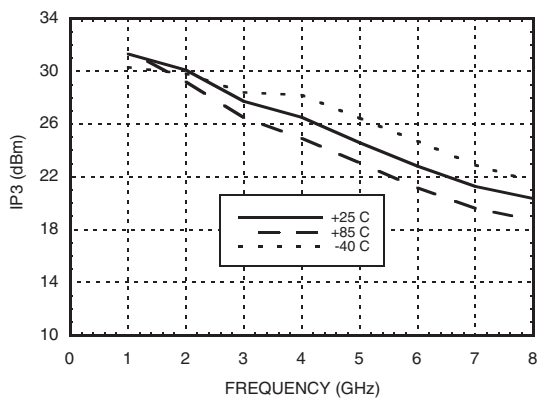

Gain, Power, OIP3 & Supply Current vs. Supply Voltage @ 1 GHz

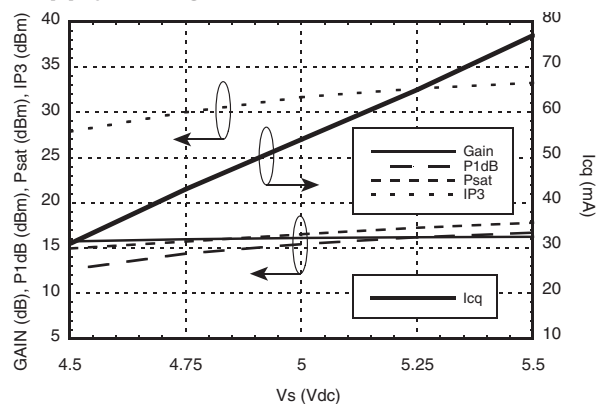

Absolute Maximum Ratings

Collector Bias Voltage (Vcc)	+7V
RF Input Power (RFIN)(Vcc = +3.9V)	+10 dBm
Junction Temperature	150 °C
Continuous P _{diss} (T = 85 °C) (derate 5.21 mW/°C above 85 °C)	0.34 W
Thermal Resistance (junction to lead)	191 °C/W
Storage Temperature	-65 to +150 °C
Operating Temperature	-40 to +85 °C



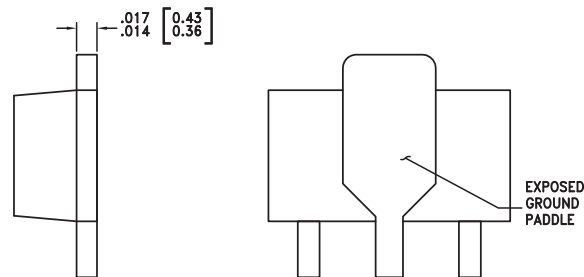
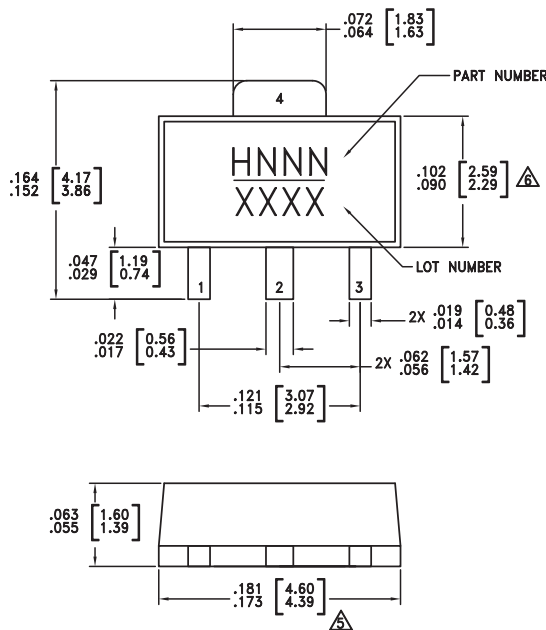

ELECTROSTATIC SENSITIVE DEVICE
OBSERVE HANDLING PRECAUTIONS

Outline Drawing



NOTES:

- PACKAGE BODY MATERIAL:
MOLDING COMPOUND MP-180S OR EQUIVALENT.
- LEAD MATERIAL: Cu w/ Ag SPOT PLATING.
- LEAD PLATING: 100% MATTE TIN.
- DIMENSIONS ARE IN INCHES [MILLIMETERS]
-  DIMENSION DOES NOT INCLUDE MOLDFLASH OF 0.15mm PER SIDE.
-  DIMENSION DOES NOT INCLUDE MOLDFLASH OF 0.25mm PER SIDE.
- ALL GROUND LEADS MUST BE SOLDERED TO PCB RF GROUND.

Package Information

Part Number	Package Body Material	Lead Finish	MSL Rating	Package Marking ^[3]
HMC311ST89	Low Stress Injection Molded Plastic	Sn/Pb Solder	MSL1 ^[1]	H311 XXXX
HMC311ST89E	RoHS-compliant Low Stress Injection Molded Plastic	100% matte Sn	MSL1 ^[2]	H311 XXXX

[1] Max peak reflow temperature of 235 °C
 [2] Max peak reflow temperature of 260 °C
 [3] 4-Digit lot number XXXX

Pin Descriptions

Pin Number	Function	Description	Interface Schematic
1	RFIN	This pin is DC coupled. An off chip DC blocking capacitor is required.	
3	RFOUT	RF output and DC Bias for the output stage.	
2, 4	GND	These pins and package bottom must be connected to RF/DC ground.	

Application Circuit

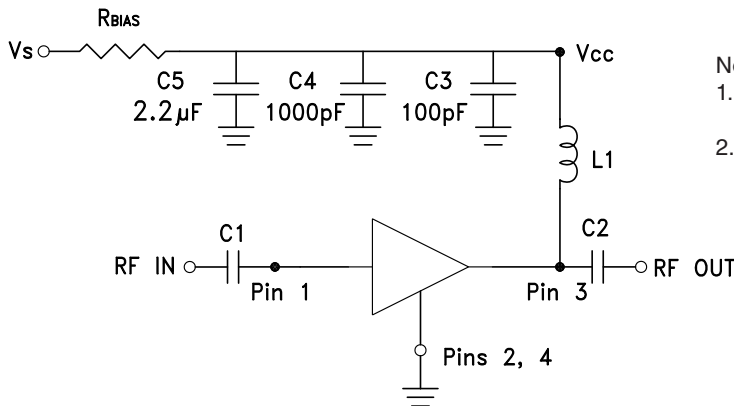

Note:

1. Select R_{bias} to achieve I_{cq} using equation below, R_{bias} ≥ 22 Ohm.
2. External blocking capacitors are required on RFIN and RFOUT.

$$I_{cq} = \frac{V_s - 3.8}{R_{bias}}$$

Recommended Component Values

Component	Frequency (MHz)							
	50	900	1900	2200	2400	3500	5200	5800
L1	270 nH	56 nH	18 nH	18 nH	15 nH	8.2 nH	3.3 nH	3.3 nH
C1, C2	0.01 μF	100 pF	100 pF	100 pF	100 pF	100 pF	100 pF	100 pF

Evaluation PCB

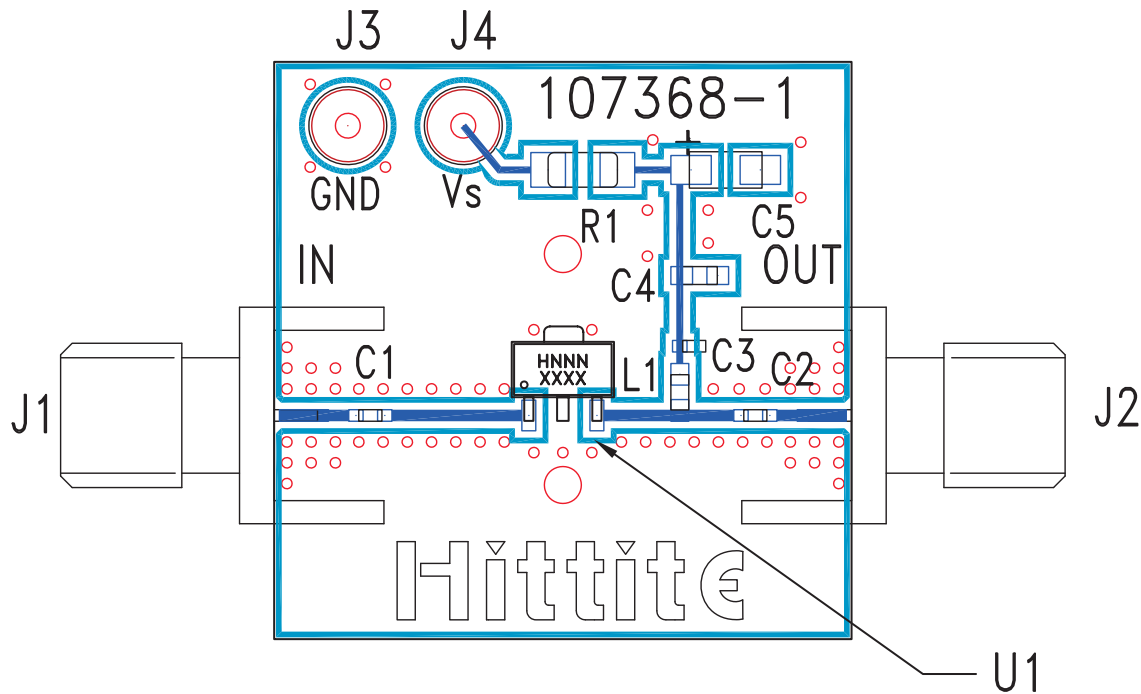

List of Materials for Evaluation PCB 108313 [1]

Item	Description
J1 - J2	PCB Mount SMA Connector
J3 - J4	DC Pin
C1, C2	Capacitor, 0402 Pkg.
C3	100 pF Capacitor, 0402 Pkg.
C4	1000 pF Capacitor, 0603 Pkg.
C5	2.2 μ F Capacitor, Tantalum
R1	Resistor, 0805 Pkg.
L1	Inductor, 0603 Pkg.
U1	HMC311ST89(E)
PCB [2]	107368 Evaluation PCB

[1] Reference this number when ordering complete evaluation PCB

[2] Circuit Board Material: Rogers 4350

The circuit board used in the final application should use RF circuit design techniques. Signal lines should have 50 Ohm impedance while the package ground leads and package bottom should be connected directly to the ground plane similar to that shown. A sufficient number of via holes should be used to connect the top and bottom ground planes. The evaluation board should be mounted to an appropriate heat sink. The evaluation circuit board shown is available from Hittite upon request.

Mouser Electronics

Authorized Distributor

Click to View Pricing, Inventory, Delivery & Lifecycle Information:

Analog Devices Inc.:

[HMC311LP3E](#) [HMC311SC70ETR](#) [HMC311SC70E](#) [HMC311ST89E](#) [HMC311ST89](#) [HMC311ST89ETR](#)
[HMC311LP3](#) [106789-HMC311LP3](#) [HMC311LP3ETR](#) [HMC311SC70](#) [118040-HMC311SC70](#) [HMC311SC70TR](#)
[HMC311ST89TR](#) [HMC311LP3TR](#) [108313-HMC311ST89](#)