

Analog Devices Welcomes Hittite Microwave Corporation

NO CONTENT ON THE ATTACHED DOCUMENT HAS CHANGED



THIS PAGE INTENTIONALLY LEFT BLANK

Typical Applications

The HMC454ST89 / HMC454ST89E is ideal for applications requiring a high dynamic range amplifier:

- GSM, GPRS & EDGE
- CDMA & W-CDMA
- CATV/Cable Modem
- Fixed Wireless & WLL

Features

- Output IP3: +40 to +42 dBm
- Gain: 12.5 dB @ 2150 MHz
- 50% PAE @ +28 dBm Pout
- +17.5 dBm W-CDMA Channel Power @ -45 dBc ACP
- Single +5V Supply
- Industry Standard SOT89 Package
- Included in the HMC-DK002 Designer's Kit

Functional Diagram

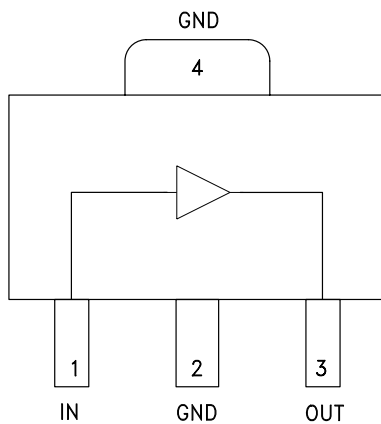

General Description

The HMC454ST89 & HMC454ST89E are high dynamic range GaAs InGaP Heterojunction Bipolar Transistor (HBT) ½ watt MMIC amplifiers operating between 0.4 and 2.5 GHz. Packaged in a low cost industry standard SOT89, the amplifier gain is typically 17.8 dB from 0.8 to 1.0 GHz and 12.5 dB from 1.8 to 2.2 GHz. Utilizing a minimum number of external components and a single +5V supply, the amplifier output IP3 can be optimized to +40 dBm at 0.9 GHz or +42 dBm at 2.0 GHz. The high output IP3 and PAE makes the HMC454ST89 an ideal driver amplifier for Cellular/PCS/3G, WLL, ISM and Fixed Wireless applications.

Electrical Specifications, $T_A = +25^\circ\text{C}$, $V_S = +5\text{V}$ [1]

| Parameter | Min. | Typ. | Max. | Min. | Typ. | Max. | Min. | Typ. | Max. | Units |
|---|-----------|-------|-------|-------------|-------|-------|-------------|-------|-------|---------|
| Frequency Range | 824 - 960 | | | 1800 - 2000 | | | 2000 - 2200 | | | MHz |
| Gain | 16 | 17.8 | | 11 | 12.5 | | 11 | 12.5 | | dB |
| Gain Variation Over Temperature | | 0.008 | 0.016 | | 0.008 | 0.016 | | 0.008 | 0.016 | dB / °C |
| Input Return Loss | | 9 | | | 7 | | | 12 | | dB |
| Output Return Loss | | 13 | | | 21 | | | 19 | | dB |
| Output Power for 1dB Compression (P1dB) | 22 | 24.5 | | 24 | 27 | | 24 | 27.5 | | dBm |
| Saturated Output Power (Psat) | | 25.5 | | | 28.5 | | | 28.5 | | dBm |
| Output Third Order Intercept (IP3) [2] | 37 | 40 | | 38 | 41 | | 38 | 42 | | dBm |
| Noise Figure | | 8 | | | 6.5 | | | 5.2 | | dB |
| Supply Current (Icq) | | 150 | 175 | | 150 | 175 | | 150 | 175 | mA |

[1] Specifications and data reflect HMC454ST89 measured using the respective application circuits for each designated frequency band found herein. Contact the HMC Applications Group for assistance in optimizing performance for your application.

[2] Two-tone input power of 0 dBm per tone, 1 MHz spacing.



HMC454ST89 / 454ST89E

InGaP HBT 1/2 WATT HIGH IP3 AMPLIFIER, 0.4 - 2.5 GHz

Broadband Gain & Return Loss @ 900 MHz

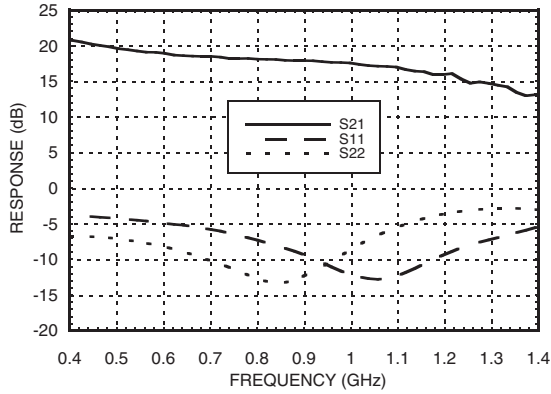

Gain vs. Temperature @ 900 MHz

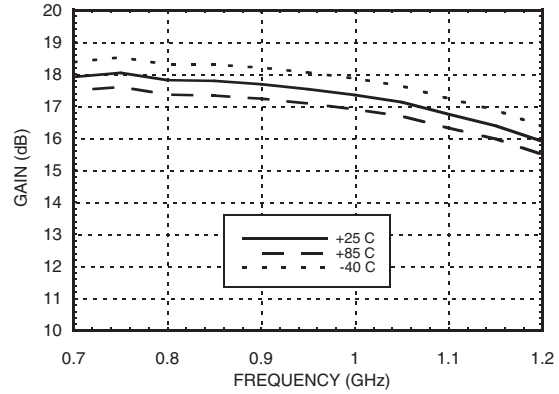

Input Return Loss vs. Temperature @ 900 MHz

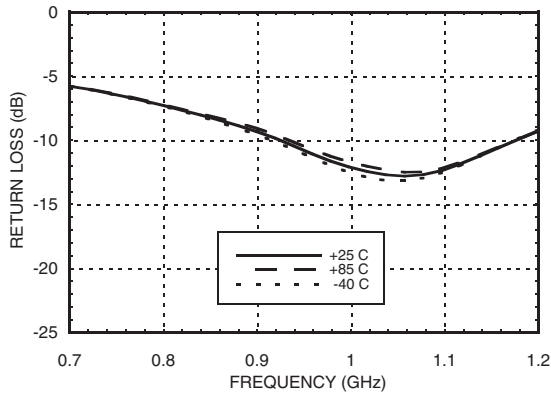

Output Return Loss vs. Temperature @ 900 MHz

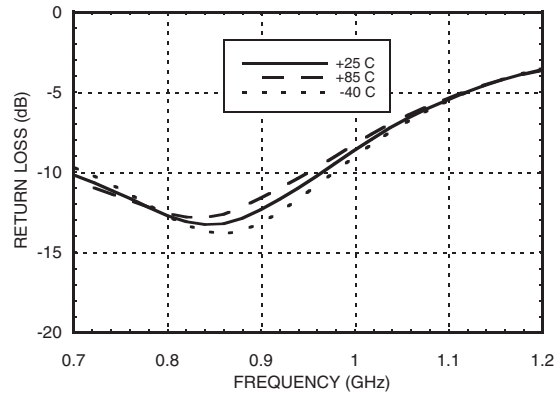

P1dB vs. Temperature @ 900 MHz

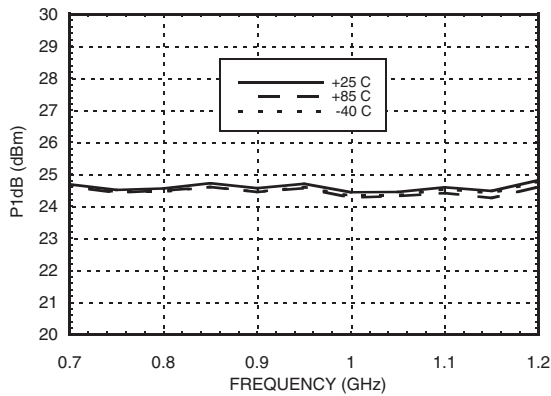

Psat vs. Temperature @ 900 MHz

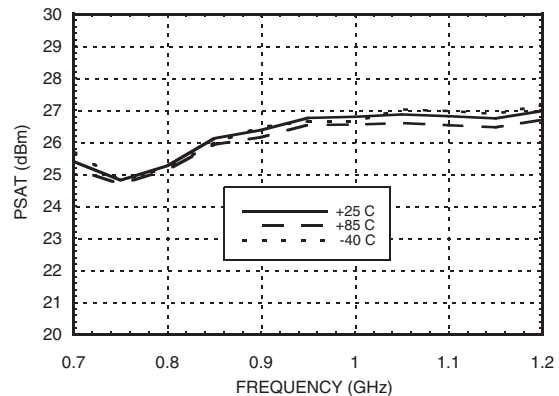



v05.0710



HMC454ST89 / 454ST89E

InGaP HBT 1/2 WATT HIGH IP3 AMPLIFIER, 0.4 - 2.5 GHz

Output IP3 vs. Temperature @ 900 MHz

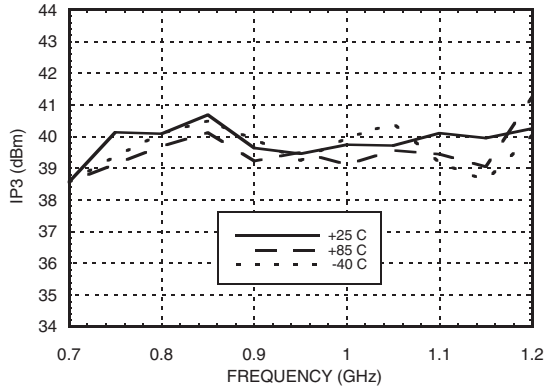

Noise Figure vs. Temperature @ 900 MHz

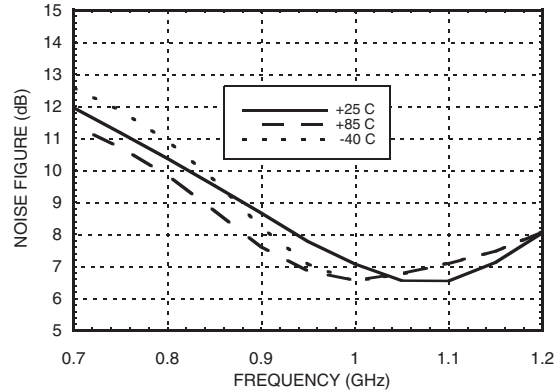

Reverse Isolation vs. Temperature @ 900 MHz

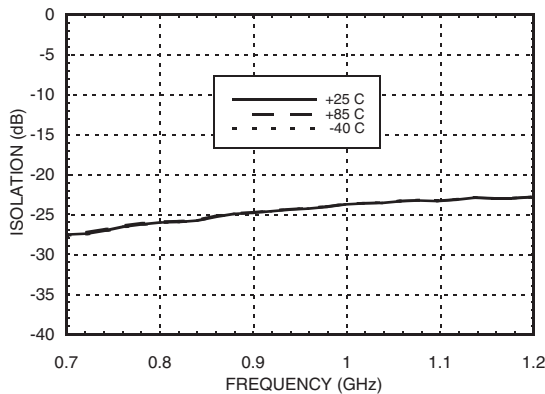

Gain, Power & Output IP3 vs. Supply Voltage @ 900 MHz

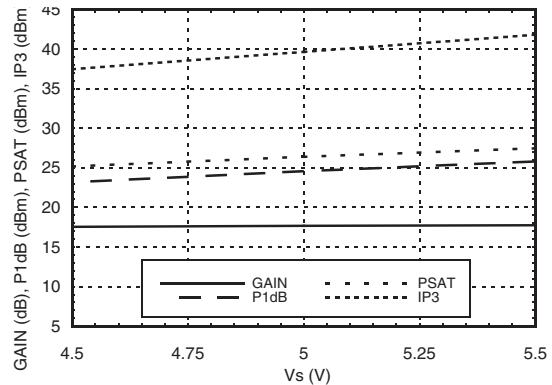

ACPR vs. Supply Voltage @ 880 MHz CDMA IS95, 9 Channels Forward

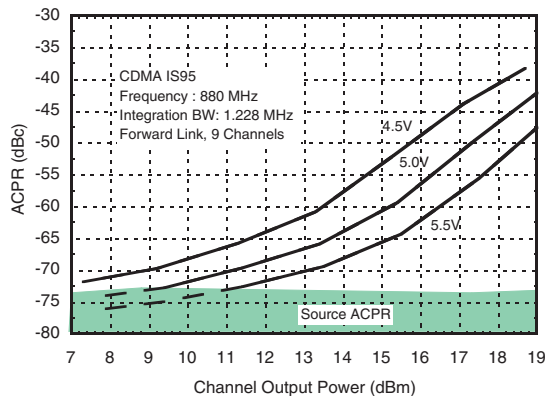



**Broadband Gain
& Return Loss @ 1960 MHz**

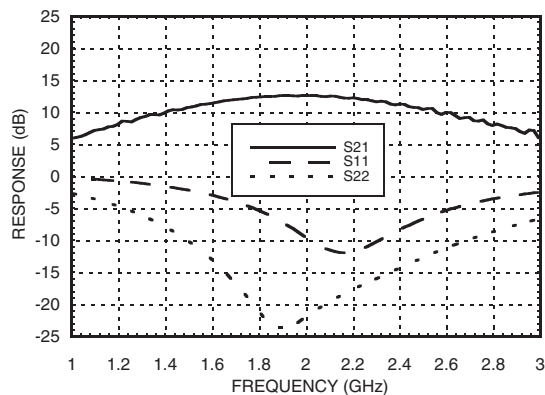

Gain vs. Temperature @ 1960 MHz

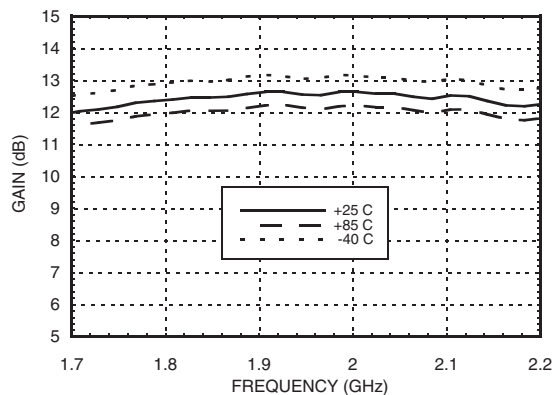

**Input Return Loss
vs. Temperature @ 1960 MHz**

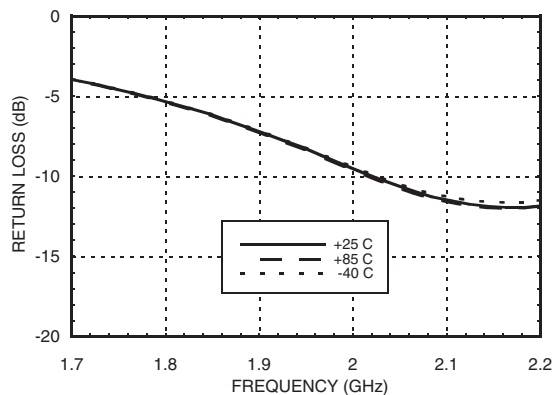

**Output Return Loss
vs. Temperature @ 1960 MHz**

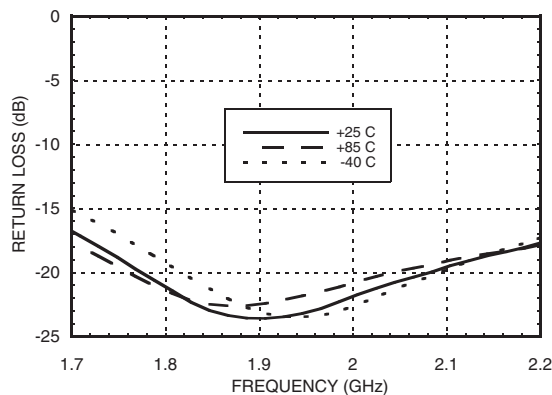

P1dB vs. Temperature @ 1960 MHz

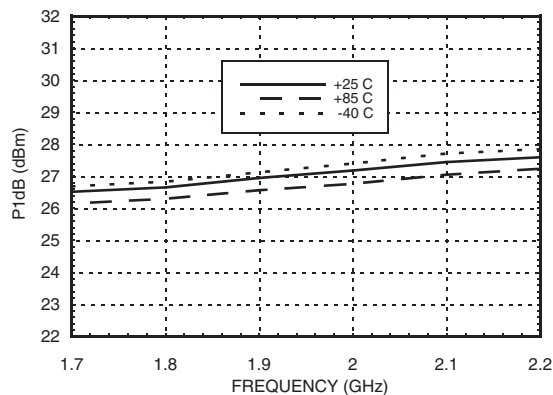

Psat vs. Temperature @ 1960 MHz

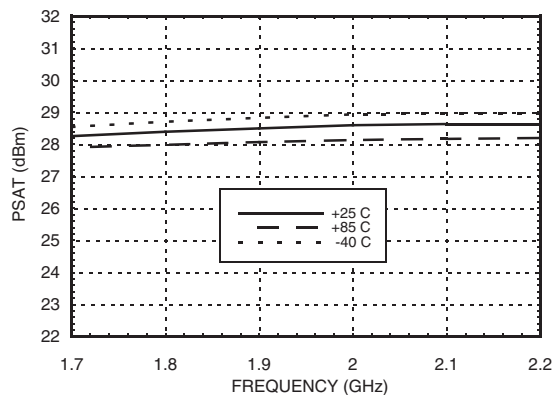



HMC454ST89 / 454ST89E

InGaP HBT 1/2 WATT HIGH IP3 AMPLIFIER, 0.4 - 2.5 GHz

9

AMPLIFIERS - LINEAR & POWER - SMT

Output IP3 vs. Temperature @ 1960 MHz

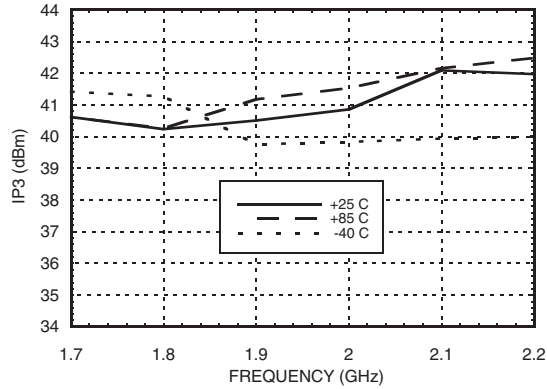

Noise Figure vs. Temperature @ 1960 MHz

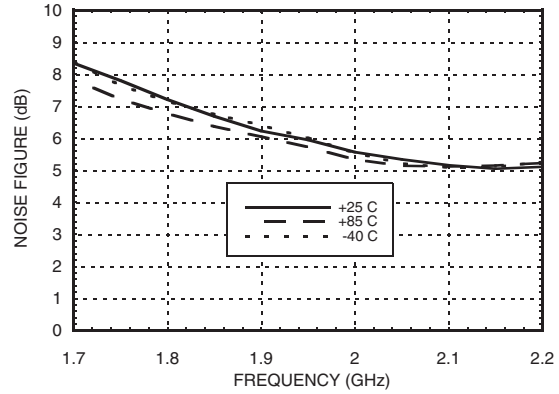

Reverse Isolation vs. Temperature @ 1960 MHz

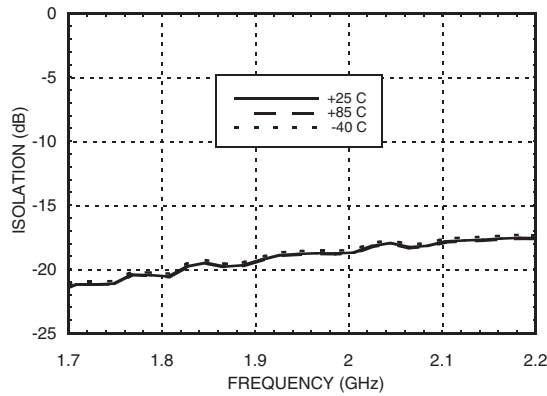

Gain, Power & Output IP3 vs. Supply Voltage @ 1960 MHz

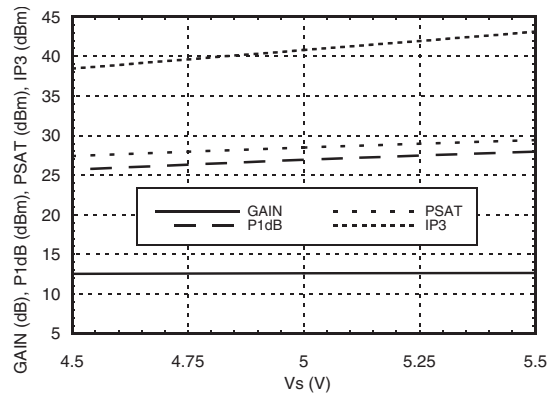

**ACPR vs. Supply Voltage @ 1.96 GHz
CDMA 2000, 9 Channels Forward**

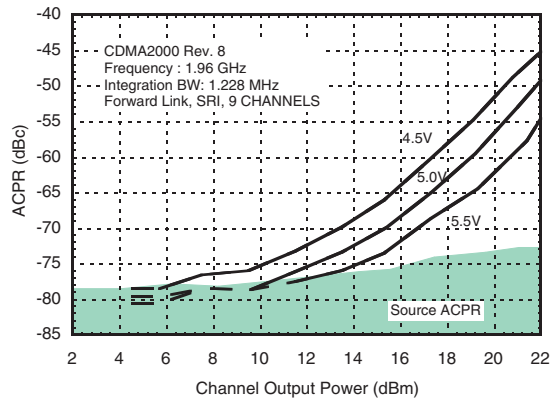

**ACPR vs. Supply Voltage @ 2.14 GHz
W-CDMA, 64 DPCH**

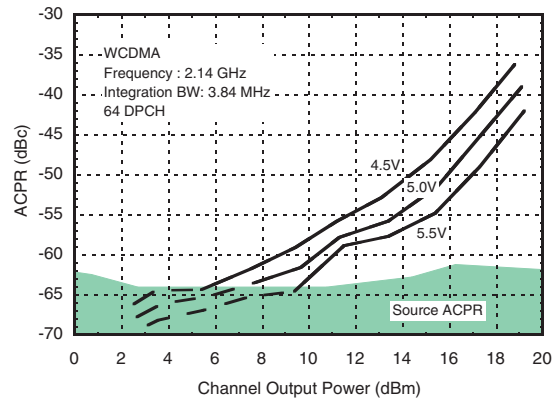

Absolute Maximum Ratings

| | |
|---|----------------|
| Collector Bias Voltage (Vcc) | +6.0 Vdc |
| RF Input Power (RFIN)(Vs = +5Vdc) | +25 dBm |
| Junction Temperature | 150 °C |
| Continuous Pdiss (T = 85 °C) (derate 13.6 mW/°C above 85 °C) | 0.890 W |
| Thermal Resistance (junction to ground paddle) | 73 °C/W |
| Storage Temperature | -65 to +150 °C |
| Operating Temperature | -40 to +85 °C |



ELECTROSTATIC SENSITIVE DEVICE
OBSERVE HANDLING PRECAUTIONS

Outline Drawing

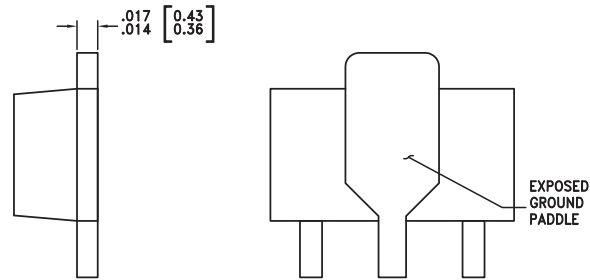
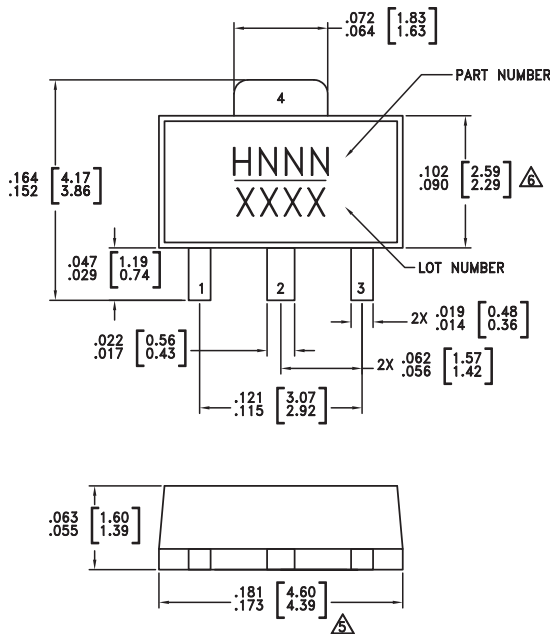

NOTES:

1. LEADFRAME MATERIAL: COPPER ALLOY
2. DIMENSIONS ARE IN INCHES [MILLIMETERS].
- ⚠ DIMENSION DOES NOT INCLUDE MOLDFLASH OF 0.15mm PER SIDE.
- ⚠ DIMENSION DOES NOT INCLUDE MOLDFLASH OF 0.25mm PER SIDE.
5. ALL GROUND LEADS MUST BE SOLDERED TO PCB RF GROUND.

Package Information



| Part Number | Package Body Material | Lead Finish | MSL Rating | Package Marking ^[3] |
|-------------|--|---------------|---------------------|--------------------------------|
| HMC454ST89 | Low Stress Injection Molded Plastic | Sn/Pb Solder | MSL1 ^[1] | H454 XXXX |
| HMC454ST89E | RoHS-compliant Low Stress Injection Molded Plastic | 100% matte Sn | MSL1 ^[2] | H454 XXXX |

[1] Max peak reflow temperature of 235 °C

[2] Max peak reflow temperature of 260 °C

[3] 4-Digit lot number XXXX

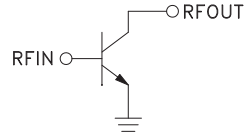
Pin Descriptions

| Pin Number | Function | Description | Interface Schematic |
|------------|----------|--|---|
| 1 | RFIN | This pin is AC coupled. Off chip matching components are required. See Application Circuit herein. |  |
| 3 | RFOUT | RF output and DC Bias input for the output amplifier stage. Off chip matching components are required. See Application Circuit herein. | |
| 2,4 | GND | These pins & package bottom must be connected to RF/DC ground. |  |

900 MHz Application Circuit, Compact Layout

This circuit was used to specify the performance for 894-960 MHz operation. This circuit will satisfy many applications from 700 to 1200 MHz. Contact the HMC Applications Group for assistance in optimizing performance for your application.

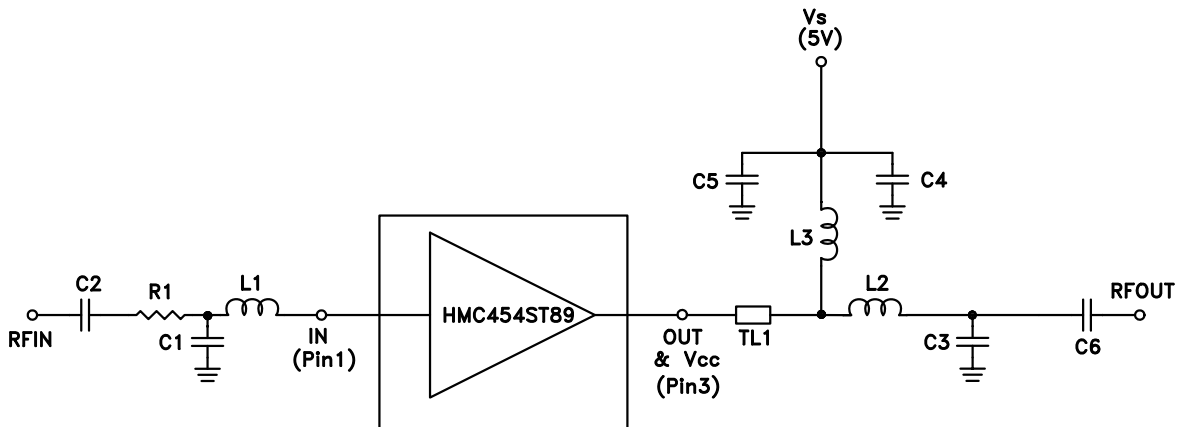

| | TL1 |
|---|--------|
| Impedance | 50 Ohm |
| Physical Length | 0.050" |
| Electrical Length | 2.5° |
| PCB Material: 10 mil Rogers 4350, Er = 3.48 | |

| Recommended Component Values | |
|------------------------------|----------|
| L1, L2 | 1 nH |
| L3 | 36 nH |
| R1 | 5.1 Ohms |
| C1 | 8 pF |
| C2 | 22 pF |
| C3 | 2.7 pF |
| C4, C6 | 100 pF |
| C5 | 2.2 μF |

900 MHz Evaluation PCB

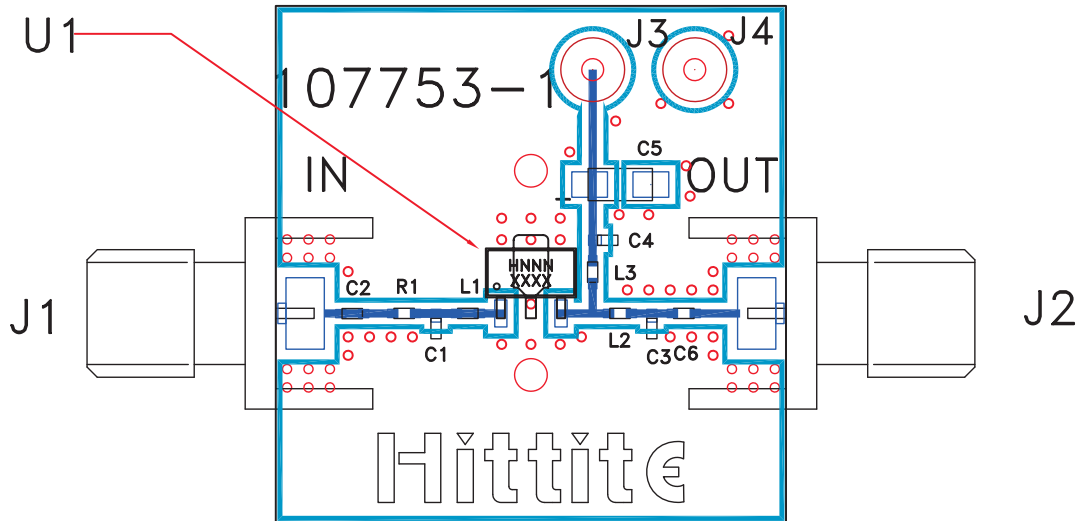

List of Materials for Evaluation PCB 107755 [1]

| Item | Description |
|---------|--|
| J1 - J2 | PCB Mount SMA Connector |
| J3 -J4 | DC Pins |
| C1 | 8 pF Capacitor, 0402 Pkg. |
| C2 | 22 pF Capacitor, 0402 Pkg. |
| C3 | 2.7 pF Capacitor, 0402 Pkg. |
| C4, C6 | 100 pF Capacitor, 0402 Pkg. |
| C5 | 2.2 μF Capacitor, Tantalum |
| L1, L2 | 1 nH Inductor, 0402 Pkg. |
| L3 | 36 nH Inductor, 0402 Pkg. |
| R1 | 5.1 Ohms |
| U1 | HMC454ST89 / HMC454ST89E Linear Amp |
| PCB [2] | 107753 Evaluation PCB, 10 mils |

[1] Reference this number when ordering complete evaluation PCB

[2] Circuit Board Material: Rogers 4350, Er = 3.48

The circuit board used in this application should use RF circuit design techniques. Signal lines should have 50 Ohm impedance while the package ground leads and exposed paddle should be connected directly to the ground plane similar to that shown. A sufficient number of via holes should be used to connect the top and bottom ground planes. The evaluation board should be mounted to an appropriate heat sink. The evaluation circuit board shown is available from Hittite upon request.

1960 & 2140 MHz Application Circuit

This circuit was used to specify the performance for 1800-2000 and 2000-2200 MHz operation. This circuit will satisfy many applications from 1700 to 2500 MHz. Contact the HMC Applications Group for assistance in optimizing performance for your application.

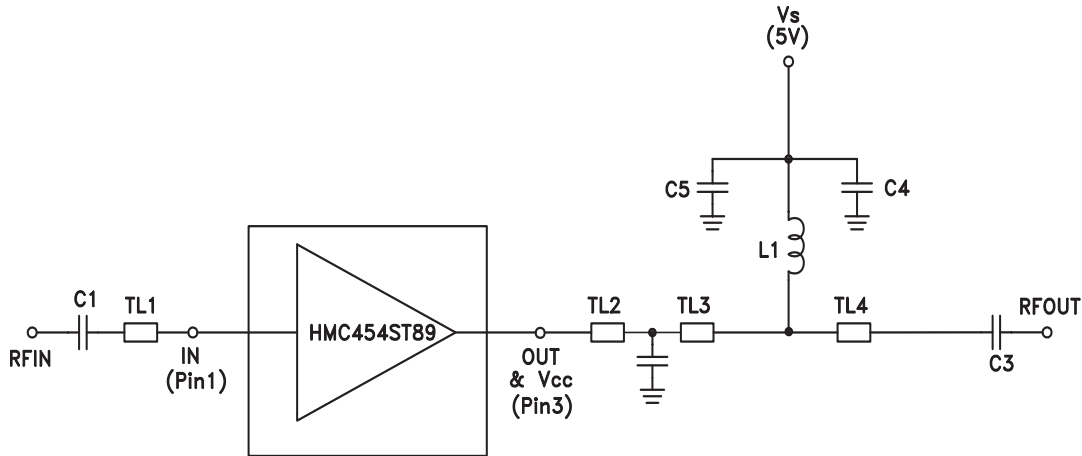

| | TL1 | TL2 | T3 | TL4 |
|---|--------|--------|--------|--------|
| Impedance | 50 Ohm | 50 Ohm | 50 Ohm | 50 Ohm |
| Physical Length | 0.32" | 0.10" | 0.07" | 0.17" |
| Electrical Length | 34° | 11° | 8° | 18.5° |
| PCB Material: 10 mil Rogers 4350, Er = 3.48 | | | | |

| Recommended Component Values | |
|------------------------------|--------|
| L1 | 8.2 nH |
| C1 | 1 pF |
| C2 | 1.2 pF |
| C3 | 3 pF |
| C4 | 100 pF |
| C5 | 2.2 μF |

1960 & 2140 MHz Evaluation PCB

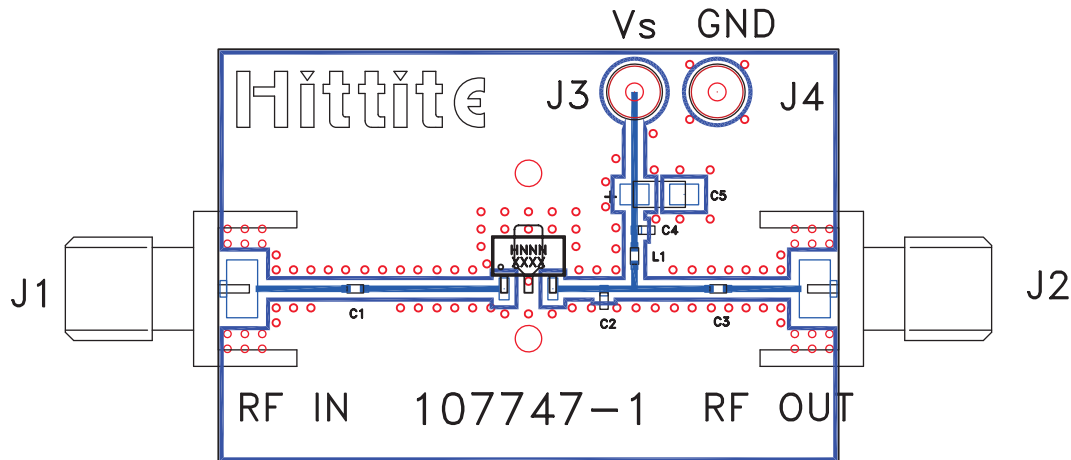

List of Materials for Evaluation PCB 107749 [1]

| Item | Description |
|---------|--------------------------------|
| J1 - J2 | PCB Mount SMA Connector |
| J3 - J4 | DC Pins |
| C1 | 1.0 pF Capacitor, 0402 Pkg. |
| C2 | 1.2 pF Capacitor, 0402 Pkg. |
| C3 | 3.0 pF Capacitor, 0402 Pkg. |
| C4 | 100 pF Capacitor, 0402 Pkg. |
| C5 | 2.2 μF Capacitor, Tantalum |
| L1 | 8.2 nH Inductor, 0402 Pkg. |
| U1 | HMC454ST89 / HMC454ST89E |
| PCB [2] | 107747 Evaluation PCB, 10 mils |

[1] Reference this number when ordering complete evaluation PCB

[2] Circuit Board Material: Rogers 4350, Er = 3.48

The circuit board used in this application should use RF circuit design techniques. Signal lines should have 50 Ohm impedance while the package ground leads and exposed paddle should be connected directly to the ground plane similar to that shown. A sufficient number of via holes should be used to connect the top and bottom ground planes. The evaluation board should be mounted to an appropriate heat sink. The evaluation circuit board shown is available from Hittite upon request.

Alternative 900 MHz Application Circuit, Optimal OIP3 Layout

This alternate application circuit for 900 MHz applications features a resonating I/O structure on the PCB that, while using more PCB area, will improve output IP3 from +40 dBm to +42 dBm. This circuit will satisfy many applications from 700 to 1200 MHz as the typical performance below demonstrates. Contact the HMC Applications Group for assistance in optimizing performance for your application.

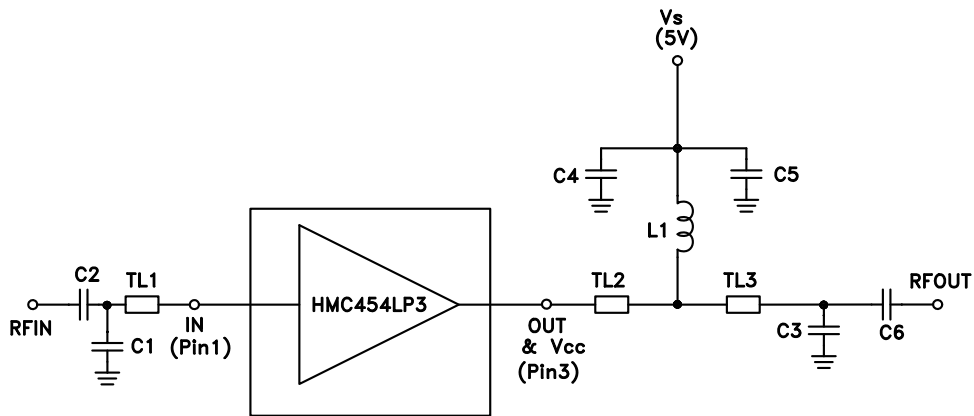

| | TL1 | TL2 | TL3 |
|---|--------|--------|--------|
| Impedance | 50 Ohm | 50 Ohm | 50 Ohm |
| Physical Length | 0.35" | 0.05" | 0.53" |
| Electrical Length | 18° | 2.5° | 27° |
| PCB Material: 10 mil Rogers 4350, Er = 3.48 | | | |

| Recommended Component Values | |
|------------------------------|--------|
| L1 | 18 nH |
| C1 | 4 pF |
| C2, C6 | 10 pF |
| C3 | 3 pF |
| C4 | 100 pF |
| C5 | 2.2 μF |

Broadband Gain & Return Loss

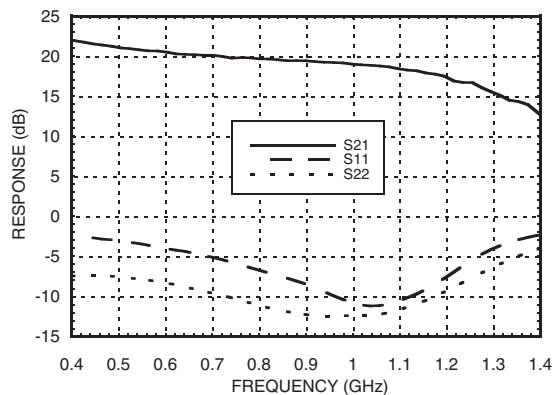

Output IP3 & P1dB

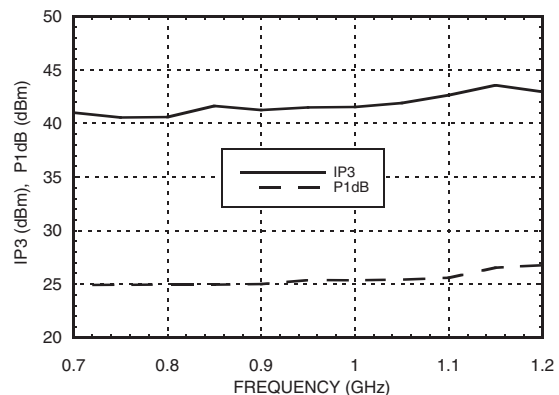

Alternate 900 MHz Evaluation PCB

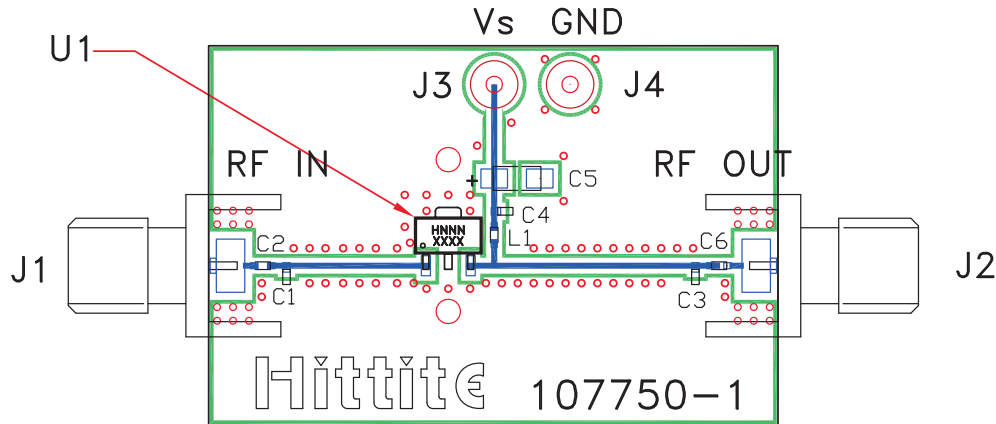

List of Materials

| Item | Description |
|---------|--------------------------------|
| J1 - J2 | PCB Mount SMA Connector |
| J3 - J4 | DC Pins |
| C1 | 4 pF Capacitor, 0402 Pkg. |
| C2, C6 | 10 pF Capacitor, 0402 Pkg. |
| C3 | 3.0 pF Capacitor, 0402 Pkg. |
| C4 | 100 pF Capacitor, 0402 Pkg. |
| L1 | 18 nH Inductor, 0402 Pkg. |
| U1 | HMC454ST89 / HMC454ST89E |
| PCB* | 107750 Evaluation PCB, 10 mils |

* Circuit Board Material: Rogers 4350, Er = 3.48

The circuit board used in this application should use RF circuit design techniques. Signal lines should have 50 Ohm impedance while the package ground leads and exposed paddle should be connected directly to the ground plane similar to that shown. A sufficient number of via holes should be used to connect the top and bottom ground planes. The evaluation board should be mounted to an appropriate heat sink. The evaluation circuit board shown is available from Hittite upon request.

Mouser Electronics

Authorized Distributor

Click to View Pricing, Inventory, Delivery & Lifecycle Information:

[Analog Devices Inc.:](#)

[HMC454ST89E](#) [HMC454ST89](#) [107755-HMC454ST89](#) [HMC454ST89ETR](#) [HMC454ST89TR](#) [107749-HMC454ST89](#)