

*RoHS COMPLIANT

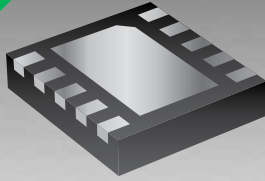

BOURNS®

Features

- Working voltage 3.3 V
- SMT - DFN package
- Low capacitance - 4 pF
- IEC 61000-4-2 (ESD)
- IEC 61000-4-4 (EFT)
- IEC 61000-4-5 (Surge)

Applications

- FireWire, T1/E1, T3/E3 chip side protection
- Digital Visual Interface (DVI)
- Ethernet 10/100/1000 Base T
- High speed port protection
- Portable electronics

CDDFN10-3304N - TVS/Steering Diode Array

General Information

The CDDFN10-3304N device provides ESD, EFT and Surge protection for high speed data ports meeting IEC 61000-4-2 (ESD), IEC 61000-4-4 (EFT) and IEC 61000-4-5 (Surge) requirements. The Transient Voltage Suppressor array, protecting up to 4 data lines, offers a Working Peak Voltage of 3.3 V.

The DFN-10 packaged device will mount directly onto the industry standard DFN-10 footprint. Bourns® Chip Diodes are easy to handle with standard pick and place equipment.

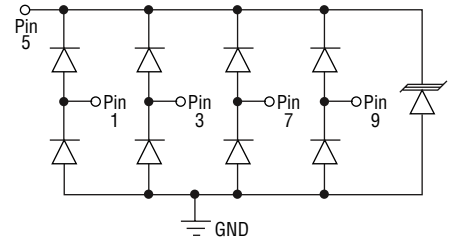

Absolute Maximum Ratings, $T_A = 25^\circ\text{C}$ (Unless Otherwise Noted)

Parameter	Symbol	CDDFN10-3304N	Unit
Peak Pulse Power ($t_p = 8/20 \mu\text{s}$) (NOTE 1)	P_{PK}	450	W
Peak Pulse Current ($t_p = 8/20 \mu\text{s}$) per IEC 61000-4-5	I_{PP}	25	A
Storage Temperature	T_{STG}	-55 to +150	$^\circ\text{C}$
Operating Temperature	T_{OPR}	-55 to +125	$^\circ\text{C}$
ESD Protection per IEC 61000-4-2			
Contact Discharge		30 max.	kV
Air Discharge		30 max.	kV
EFT Protection per IEC 61000-4-4 @ 5/50 ns		40 min.	A

Notes:

1. See Peak Pulse Power vs. Pulse Time.

Electrical Characteristics (@ $T_A = 25^\circ\text{C}$ Unless Otherwise Noted)

Parameter	Symbol	Min.	Typ.	Max.	Unit
Breakdown Voltage @ 1 mA	V_{BR}	3.9			V
Working Peak Voltage	V_{WM}			3.3	V
Leakage Current ¹ @ V_{WM}	I_D			1	μA
Clamping Voltage ² @ $I_P = 5 \text{ A } 8/20 \mu\text{s}$	V_C			15	V
Clamping Voltage ² @ $I_P = 15 \text{ A } 8/20 \mu\text{s}$	V_C			18	V
Clamping Voltage ² @ $I_P = 20 \text{ A } 8/20 \mu\text{s}$	V_C			20	V
Junction Capacitance ² @ 0 V 1 MHz	C_D		4.0	5.0	pF
Junction Capacitance ³ @ 0 V 1 MHz	C_{IO}		1.5		pF

Note 1: Pin 5 to ground.

Note 2: Pin 1,3,7 or 9 to ground.

Note 3: Between Pin 1,3,7 and 9.

*RoHS Directive 2002/95/EC Jan. 27, 2003 including annex and RoHS Recast 2011/65/EU June 8, 2011.

Specifications are subject to change without notice.

The device characteristics and parameters in this data sheet can and do vary in different applications and actual device performance may vary over time.

Users should verify actual device performance in their specific applications.

CDDFN10-3304N - TVS/Steering Diode Array



Rating & Characteristic Curves

Peak Pulse Power vs. Pulse Time

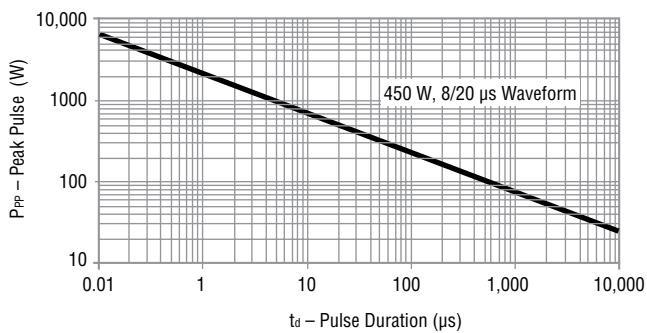

Pulse Waveform

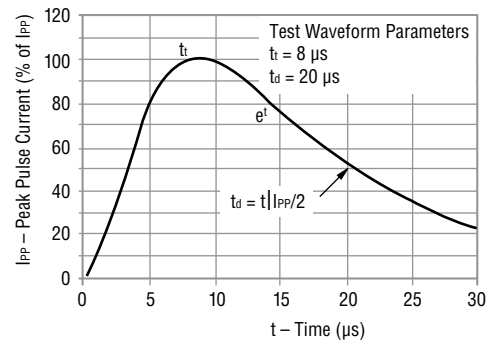

Clamping Voltage vs Peak Pulse Current

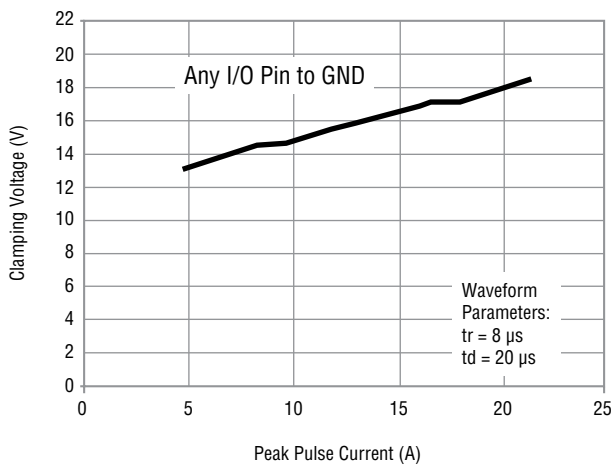

Clamping Voltage vs Peak Pulse Current

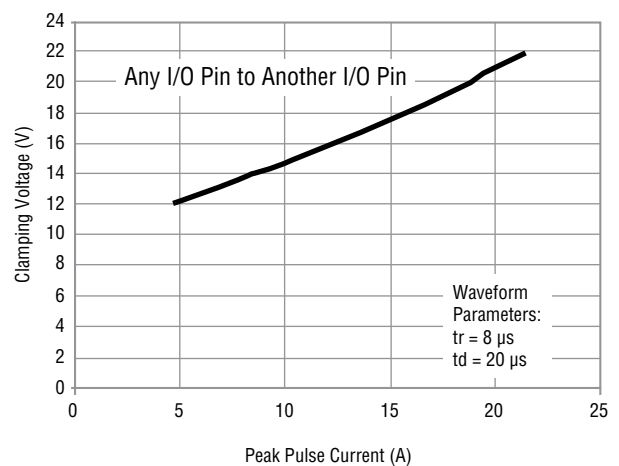

Typical Voltage vs. Capacitance

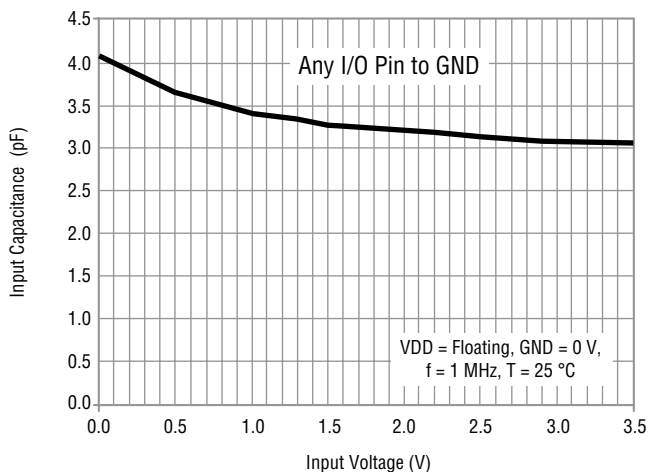

Power Derating Curve

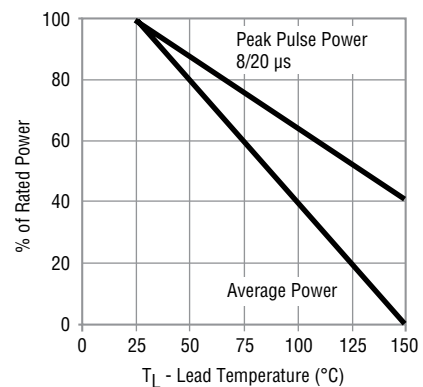

Specifications are subject to change without notice.
 The device characteristics and parameters in this data sheet can and do vary in different applications and actual device performance may vary over time.
 Users should verify actual device performance in their specific applications.

CDDFN10-3304N - TVS/Steering Diode Array



Product Dimensions

This is a molded DFN10 package with lead free Nickel-Paladium-Gold (Ni/Pd/Au) on the lead frame. It has a flammability rating of UL 94V-0.

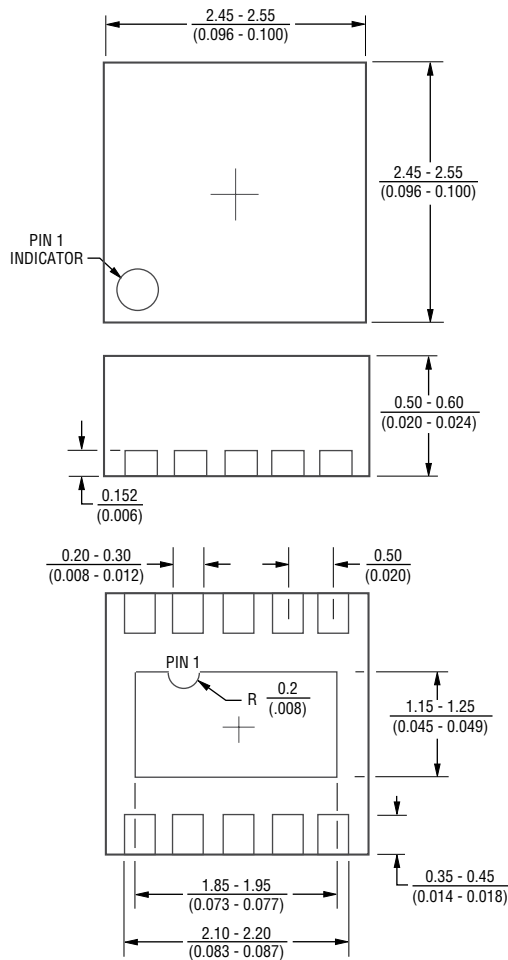

How to Order

CD DFN10 - 33 04 N

Common Diode _____
 Chip Diode _____
 Package _____
 DFN10 = DFN-10 Package _____
 Working Peak Voltage _____
 33 = 3.3 V_{RWM} (Volts) _____
 Number of Lines _____
 04 = 4 Data Lines _____
 Suffix _____
 N = Low Capacitance _____

Recommended Footprint

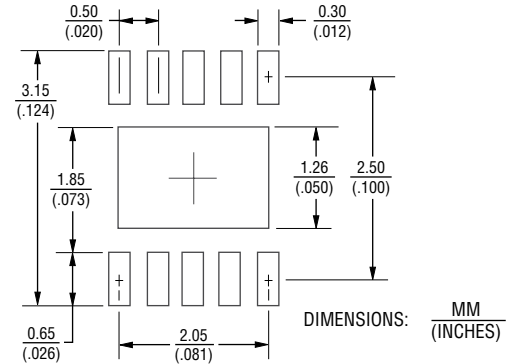

Typical Part Marking

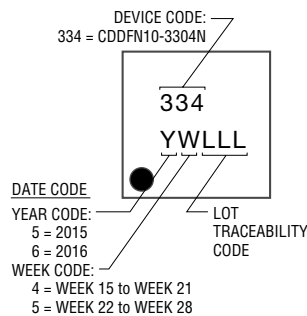

Week Code	Duration
2	Week 1~Week 7
3	Week 8~Week 14
4	Week 15~Week 21
5	Week 22~Week 28
6	Week 29~Week 35
7	Week 36~Week 42
8	Week 43~Week 49
9	Week 50~Week 52

Pin Out

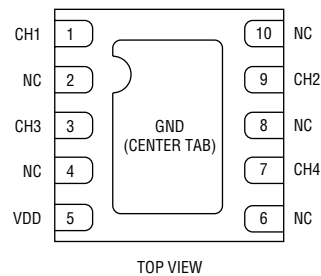

Pin	Function
1	I/O
2	N.C.
3	I/O
4	N.C.
5	V _{CC}
6	N.C.
7	I/O
8	N.C.
9	I/O
10	N.C.
CENTER TAB	GROUND

CDDFN10-3304N - TVS/Steering Diode Array

BOURNS®

Packaging Information

The product will be dispensed in tape and reel format (see diagram below).

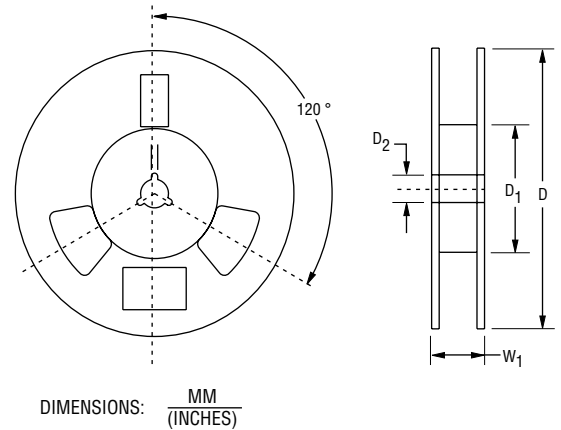
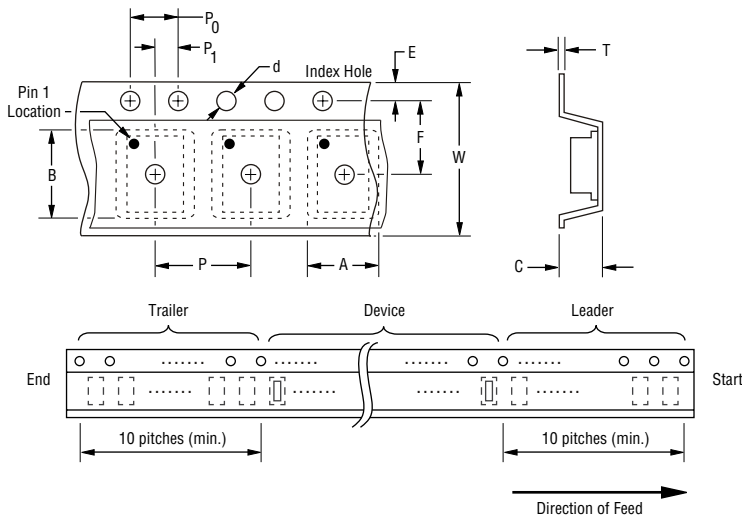

Devices are packed in accordance with EIA standard RS-481-A.

Item	Symbol	DFN-10
Carrier Width	A	$\frac{2.80 \pm 0.10}{(0.110 \pm 0.004)}$
Carrier Length	B	$\frac{2.85 \pm 0.10}{(0.112 \pm 0.004)}$
Carrier Depth	C	$\frac{1.00 \pm 0.05}{(0.039 \pm 0.002)}$
Sprocket Hole	d	$\frac{1.50 +0.10/-0}{(0.059 +0.004/-0)}$
Reel Outside Diameter	D	$\frac{180 \pm 3}{(7.087 \pm 0.118)}$
Reel Inner Diameter	D ₁	$\frac{50.0}{(1.969)}$ MIN.
Feed Hole Diameter	D ₂	$\frac{13.00 +0.50/-0.20}{(0.512 +0.020/-0.008)}$
Sprocket Hole Position	E	$\frac{1.75 \pm 0.10}{(0.069 \pm 0.004)}$
Punch Hole Position	F	$\frac{5.50 \pm 0.05}{(0.217 \pm 0.002)}$
Punch Hole Pitch	P	$\frac{4.00 \pm 0.10}{(0.157 \pm 0.004)}$
Sprocket Hole Pitch	P ₀	$\frac{4.00 \pm 0.10}{(0.157 \pm 0.004)}$
Embossment Center	P ₁	$\frac{2.00 \pm 0.05}{(0.079 \pm 0.002)}$
Overall Tape Thickness	T	$\frac{0.60}{(0.024)}$ MAX.
Tape Width	W	$\frac{12.3}{(0.484)}$ MAX.
Reel Width	W ₁	$\frac{18.4}{(0.724)}$ MAX.
Quantity per Reel	--	3000

REV. 08/16

Specifications are subject to change without notice. The device characteristics and parameters in this data sheet can and do vary in different applications and actual device performance may vary over time. Users should verify actual device performance in their specific applications.

Mouser Electronics

Authorized Distributor

Click to View Pricing, Inventory, Delivery & Lifecycle Information:

Bourns:

[CDDFN10-3304N](#)