

# MGA-665P8

## GaAs Enhancement-Mode PHEMT

### 0.5 – 6 GHz Low Noise Amplifier



## Data Sheet

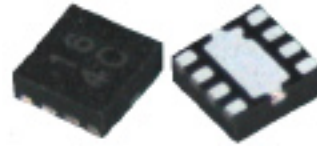

### Description

Avago's MGA-665P8 is an economical, easy-to-use GaAs MMIC Low Noise Amplifier (LNA) with a unique active-low power-down function. The LNA has low noise figure and high gain achieved through the use of Avago Technologies' proprietary GaAs Enhancement-mode PHEMT process. It is housed in a miniature 2.0 x 2.0 x 0.75 mm 8-pin Leadless-Plastic-Chip-Carrier (LPCC) package. The compact footprint and low profile coupled with low noise, high gain and high linearity makes the MGA-665P8 an ideal choice as an LNA for broadband general-purpose applications. Its excellent broadband isolation also makes it a good buffer amplifier.

The output of the MGA-665P8 provides a very good broadband match to 50 Ω. Its input requires a simple external LC network to provide a low noise figure and good input return loss. Power supply voltage is applied to both the output terminal and a separate  $V_D$  terminal. A simple external bias insertion circuit consisting of a shunt inductor and a series dc block capacitor is sufficient to apply power supply voltage to the output of the MGA-665P8. The MGA-665P8 provides typical device performance of 1.45 dB noise figure, 16 dB gain and an OIP3 of +18.1 dBm at 5.25 GHz, at a bias point of 3 V and 20.5 mA.

### Features

- Surface Mount, 2.0 x 2.0 x 0.75 mm 8-lead LPCC
- Active-low power-down function
- Single +3 V supply operation
- Low noise and high gain MMIC
- Output 50 Ω match
- Excellent isolation
- Minimal match and external biasing components
- Housed in miniature 2 x 2 x 0.75 mm LPCC package
- Pb-free & MSL-1 package

### Specifications

- 0.5 to 6 GHz operation
- At 3 V, 20.5 mA, 2.4 GHz:  
NF = 1.2 dB  
Gain = 18.4 dB  
OIP3 = 19 dBm
- At 3 V, 20.5 mA, 5.25 GHz:  
NF = 1.45 dB  
Gain = 16 dB  
OIP3 = 18.1 dBm

### Pin Configuration, Top View

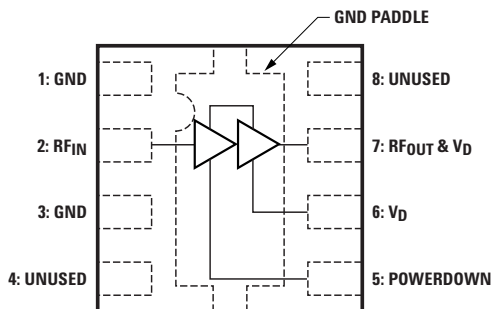

**POWER DOWN FUNCTION:**  
LOGIC LOW (0-1 V): POWER ON  
LOGIC HIGH (2-3 V): POWER OFF

**NOTES:**  
1. PINS 1, 3, AND PADDLE NEED TO BE PROPERLY GROUNDED TO OBTAIN SPECIFIED PERFORMANCE.  
2. SUPPLY VOLTAGE,  $V_D$ , NEEDS TO BE APPLIED AT PINS 6 & 7. SUPPLY AT PIN 7 TO BE APPLIED USING A BIAS TEE OR EQUIVALENT.



**Attention:** Observe precautions for handling electrostatic sensitive devices.  
ESD Machine Model = 40 V  
ESD Human Body Model = 150 V  
Refer to Avago Application Note A004R: *Electrostatic Discharge, Damage and Control*.

**Table 1. Absolute Maximum Ratings<sup>[1]</sup>**

Symbol	Parameter	Units	Absolute Maximum
V <sub>D</sub>	Supply Voltage <sup>[2]</sup>	V	6
V <sub>C</sub>	Control Voltage <sup>[2]</sup>	V	6
I <sub>D</sub>	Drain Current <sup>[2]</sup>	mA	45.6
P <sub>diss</sub>	Total Power Dissipation <sup>[3]</sup>	W	0.27
Pin max.	RF Input Power	dBm	13
T <sub>CH</sub>	Channel Temperature	°C	150
T <sub>STG</sub>	Storage Temperature	°C	-65 to 150
θ <sub>ch_b</sub>	Thermal Resistance <sup>[4]</sup>	°C/W	44.76

**Notes:**

1. Operation of this device above any one of these parameters may cause permanent damage.
2. DC quiescent conditions.
3. Board (package belly) temperature T<sub>B</sub> is 25°C. Derate 29 mW/°C for T<sub>B</sub> > 133°C.
4. Channel-to-board thermal resistance measured using 150°C Liquid Crystal Measurement method.

**Product Consistency Distribution Charts at 5.25 GHz, 3.0 V, I<sub>d</sub> = 20.5 mA<sup>[5,6]</sup>**

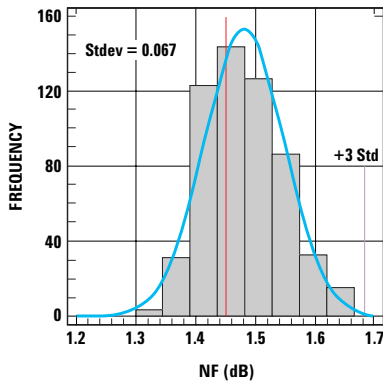

**Figure 1. NF; nominal = 1.45.**

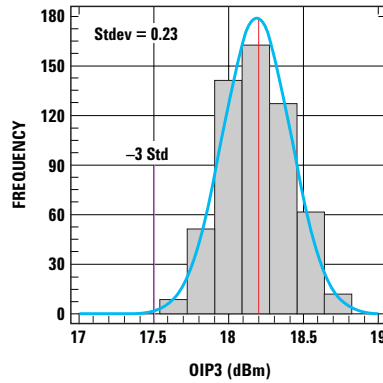

**Figure 2. OIP3; LSL = 17.8, nominal = 18.2.**

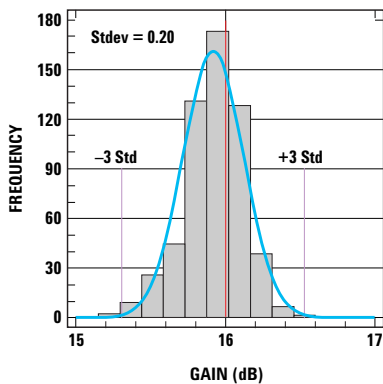

**Figure 3. Gain (dB); nominal = 16 dB.**

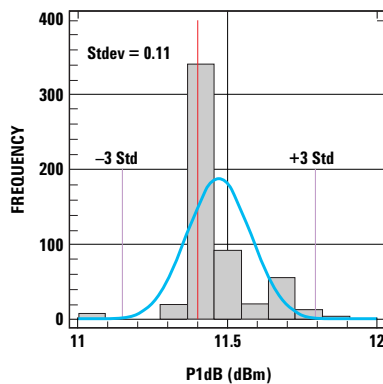

**Figure 4. P1dB; LSL = 11, nominal = 11.4.**

**Notes:**

5. Distribution data sample size is 500 samples taken from 3 different wafers lots. Future wafers allocated to this product may have nominal values anywhere between the upper and lower limits.
6. Measurements are made on production test board described in Figure 5, which represents a trade-off between optimal OIP3, P1dB, Gain and NF. Circuit losses have been de-embedded from actual measurements

**Table 2. MGA-665P8 Electrical Specifications**

$T_A = 25^\circ\text{C}$ , DC Bias for RF Parameter is  $V_D = 3.0\text{ V}$  (unless otherwise specified)

Symbol	Parameter and Test Condition	Units	Min.	Typ.	Max.
$V_C$	Control Voltage	V	-	ON: 0–1 V Off: 2–3 V	-
$I_D$	Device Current	mA	18.2	20.5	23.8
$I_D$ (Off)	Off current	$V_C = 3\text{ V}$ $\mu\text{A}$	-	180	220
$G_{\text{test}}^{[7]}$	Gain	Freq = 5.25 GHz dB	14.5	16	17.5
$NF_{\text{test}}^{[7]}$	Noise Figure	Freq = 5.25 GHz dB	-	1.45	1.9
$OIP3_{\text{test}}^{[7,8]}$	Output Third Order Intercept Point	Freq = 5.25 GHz dBm	16.5	18.2	-
$P1\text{dB}_{\text{test}}^{[7]}$	Output Power at 1dB Gain Compression	Freq = 5.25 GHz dBm	-	11.4	-
$Psat_{\text{test}}^{[7]}$	Output Power at Saturation	Freq = 5.25 GHz dBm	-	15	-
$IRL_{\text{test}}^{[7]}$	Input return Loss	Freq = 5.25 GHz dB	-	18	-
$ORL_{\text{test}}^{[7]}$	Output Return Loss	Freq = 5.25 GHz dB	-	20	-
$G_a^{[8]}$	Associated Gain at $NF_o$	Freq = 0.9 GHz Freq = 2.4 GHz Freq = 3.5 GHz Freq = 5.25 GHz Freq = 5.8 GHz dB	-	22.58 18.42 16.99 16.00 17.16	-
$NF_o^{[8]}$	Optimum Noise Figure (Tuned for Lowest Noise Figure)	Freq = 0.9 GHz Freq = 2.4 GHz Freq = 3.5 GHz Freq = 5.25 GHz Freq = 5.8 GHz dB	-	1.30 1.18 1.36 1.45 1.44	-
$OIP3^{[8,9]}$	Output Third Order Intercept Point at $NF_o$	Freq = 0.9 GHz Freq = 2.4 GHz Freq = 3.5 GHz Freq = 5.25 GHz Freq = 5.8 GHz dBm	-	21.26 19.02 17.30 18.10 17.89	-
$P1\text{dB}^{[8]}$	Output Power at 1 dB Gain Compression Point at $NF_o$	Freq = 0.9 GHz Freq = 2.4 GHz Freq = 3.5 GHz Freq = 5.25 GHz Freq = 5.8 GHz dBm	-	8.62 7.41 6.89 7.80 8.32	-

**Notes:**

- Measurements obtained using production test board described in Figure 5, which represents a trade-off between optimal OIP3, P1dB, Gain and NF. Circuit losses have been de-embedded from actual measurements.
- Measurements obtained using test fixture with input tuned for low noise figure. Gain, OIP3 and P1dB were measured at this tuned condition. Tuner and fixture losses have been de-embedded from actual measurements. The supply is connected to ground via a bypass capacitor. The OIP3 is approximately 3 dB lower without this bypass capacitor.
- OIP3 test condition:  $P_{in} = -20\text{ dBm}$ ,  $\Delta f = f_1 - f_2 = 10\text{ MHz}$ .

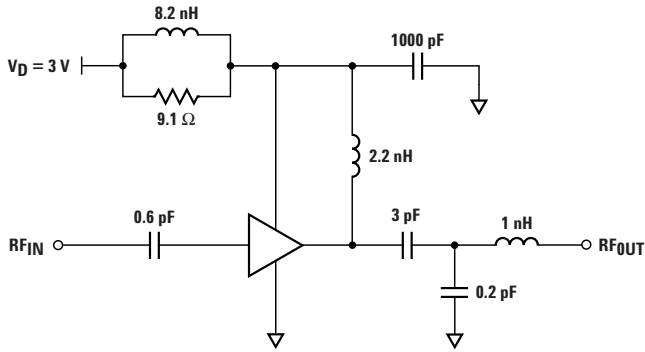

Figure 5: Simplified schematic of 5.25 GHz production test board, which represents a tradeoff between Gain, NF, OIP3, P1dB and return loss measurements. Circuit losses have been de-embedded from actual measurements.

**MGA-665P8 DC Performance Curves (at 25°C unless specified otherwise)**

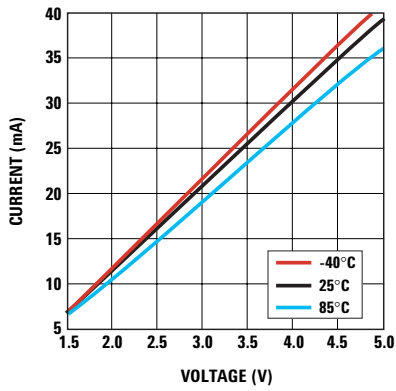

Figure 6. Current vs. supply voltage.

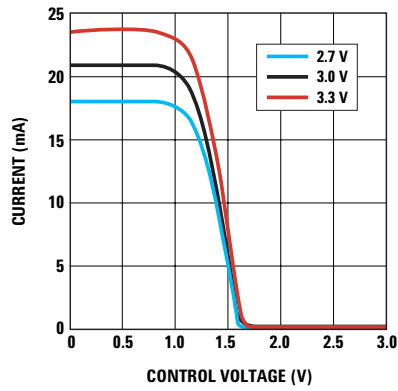

Figure 7. Current vs. control voltage.

**MGA-665P8 Performance Curves Tuned For NFmin at  $V_D = 3.0\text{ V}$ ,  $V_C = 0\text{ V}$ ,  $I_D = 20.5\text{ mA}$ <sup>[10]</sup>  
(at 25°C unless specified otherwise)**

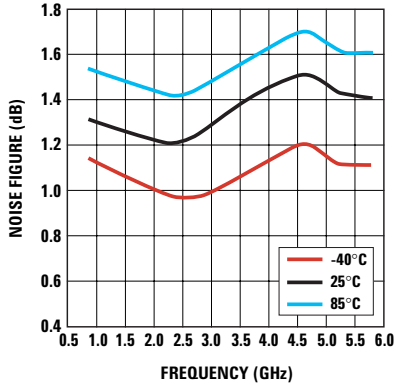

Figure 8. Minimum noise figure vs. frequency and temperature.

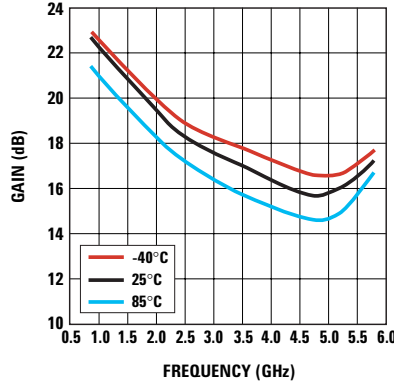

Figure 9. Associated gain measured at NFmin tuned condition vs. frequency and temperature.

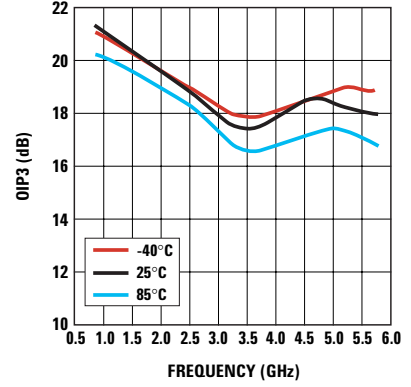

Figure 10. Output third order intercept point measured at NFmin tuned condition vs. frequency and temperature.

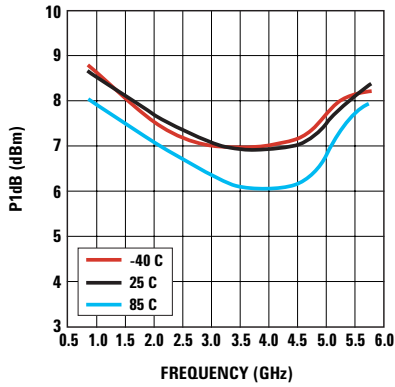

Figure 11. Output power for 1 dB gain compression measured at NFmin tuned condition vs. frequency and temperature.

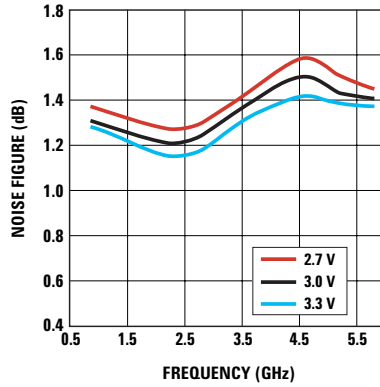

Figure 12. Minimum noise figure vs. frequency and voltage.

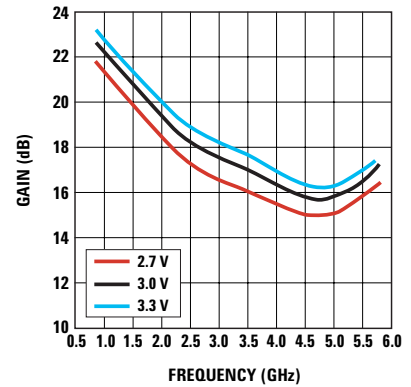

Figure 13. Associated gain measured at NFmin tuned condition vs. frequency and voltage.

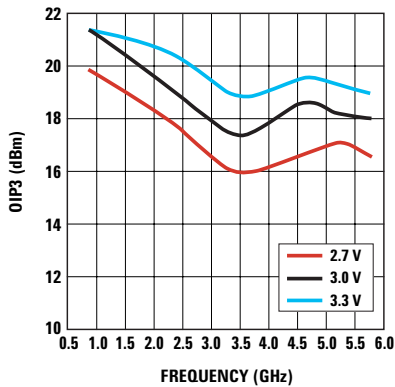

Figure 14. Output third order intercept point measured at NFmin tuned condition vs. frequency and voltage.

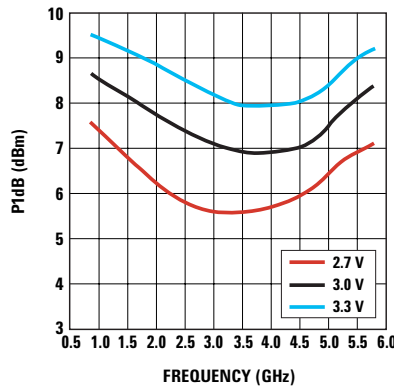

Figure 15. Output power for 1 dB gain compression measured at NFmin tuned condition vs. frequency and voltage.

**Note:**

10. Measurements obtained using test fixture with input tuned for low noise figure with a double stub tuner. Gain, OIP3 and P1dB were measured at this tuned condition. Tuner and fixture losses have been de-embedded from actual measurements. The supply is connected to ground via a bypass capacitor. The OIP3 is approximately 3dB lower without this bypass capacitor.

**MGA-665P8 Performance Curves with 50 Ω Input and Output at  $V_D = 3.0\text{ V}$ ,  $V_C = 0\text{ V}$ ,  $I_D = 20.5\text{ mA}$ <sup>[11]</sup>  
(at 25°C unless specified otherwise)**

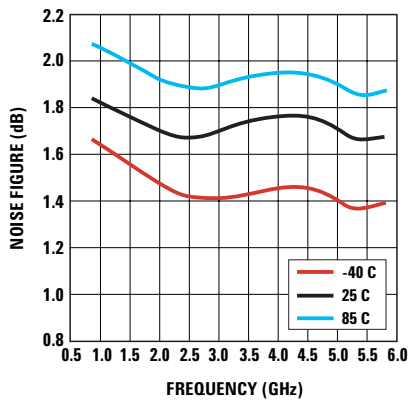

Figure 16. Noise figure (50 Ω) vs. frequency and temperature.

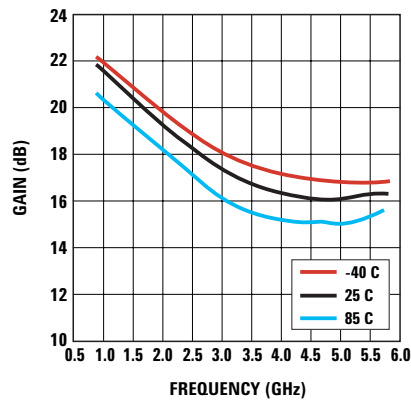

Figure 17. Gain (50 Ω) vs. frequency and temperature.

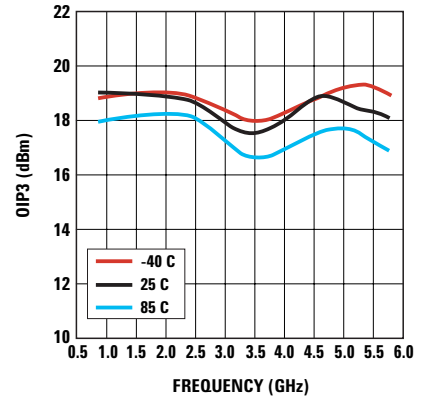

Figure 18. Output third order intercept point (50 Ω) vs. frequency and temperature.

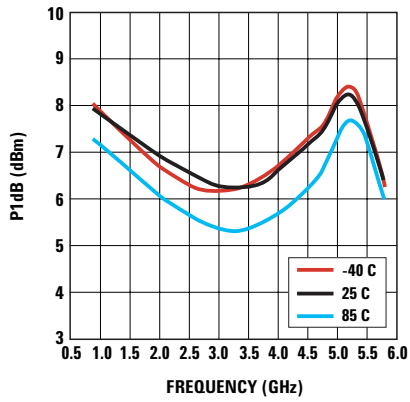

Figure 19. Output power for 1 dB gain compression (50 Ω) vs. frequency and temperature.

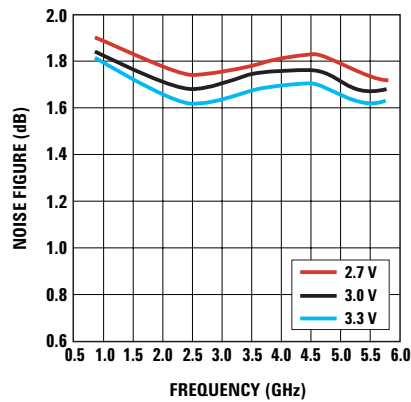

Figure 20. Noise figure (50 Ω) vs. frequency and voltage.

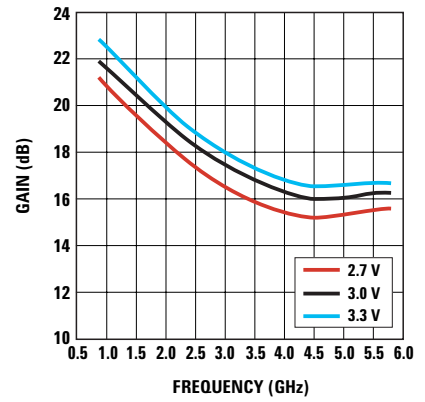

Figure 21. Gain (50 Ω) vs. frequency and voltage.

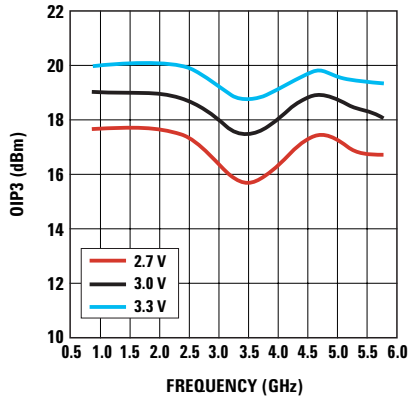

Figure 22. Output third order intercept point (50  $\Omega$ ) vs. frequency and temperature.

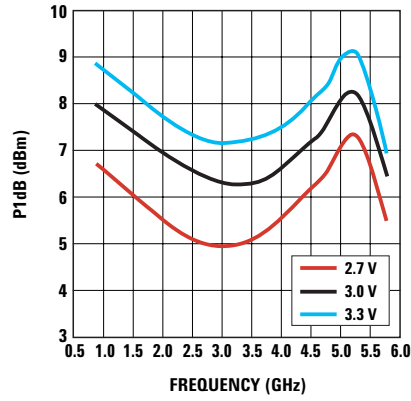

Figure 23. Output power for 1 dB gain compression (50  $\Omega$ ) vs. frequency and voltage.

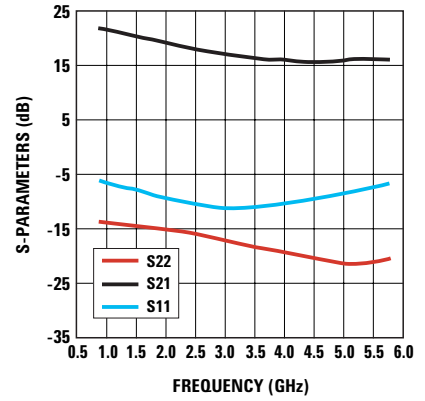

Figure 24. S-Parameters (50  $\Omega$ ) vs. frequency.

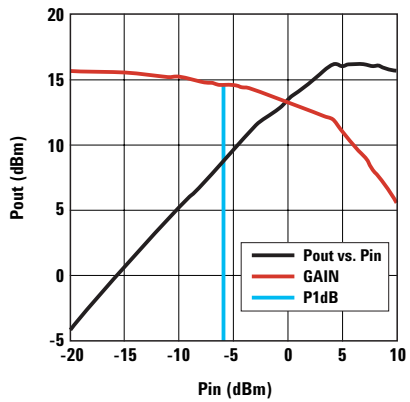

Figure 25. Output power and gain vs. input power at 5.25 GHz.

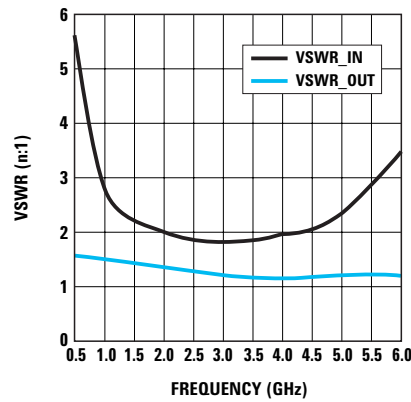

Figure 26. Input and output VSWR (50  $\Omega$ ) vs. frequency.

**Note:**

11. Measurements obtained using a 50  $\Omega$  test fixture with input and output connected directly to the fixture. Gain, OIP3 and P1dB were measured at this 50  $\Omega$  condition.

**MGA-665P8 Typical Scattering Parameters,  $T_C = 25^\circ\text{C}$ ,  $Z_0 = 50 \Omega$ ,  $V_D = 3 \text{ V}$ ,  $V_C = 0 \text{ V}$ ,  $I_D = 20.5 \text{ mA}$  (ON State)<sup>[12]</sup>**

Freq (GHz)	S11		S21		S12		S22		K-factor
	dB	Ang (deg)	dB	Ang (deg)	dB	Ang (deg)	dB	Ang (deg)	
0.1	-0.25	-12.7	15.56	43.5	-60.00	114.3	-10.17	-39.8	$\infty$
0.5	-3.06	-43.6	21.14	0.9	-60.00	104.2	-13.64	-18.8	$\infty$
1.0	-6.47	-60.0	21.60	-41.0	-60.00	101.8	-14.38	-23.2	30.94
1.5	-8.71	-70.1	20.63	-71.4	-53.98	100.7	-15.28	-31.9	19.48
2.0	-9.92	-79.8	19.48	-95.6	-53.98	94.4	-17.27	-39.4	23.35
2.2	-10.43	-80.6	19.00	-104.3	-50.46	93.6	-18.06	-41.9	16.71
2.4	-10.81	-82.8	18.60	-112.5	-50.46	90.8	-18.56	-45.9	17.69
2.6	-10.87	-85.3	18.18	-120.3	-50.46	89.2	-19.41	-49.2	18.63
2.8	-11.21	-86.9	17.83	-128.1	-47.96	91.5	-20.00	-53.7	14.68
3.0	-11.15	-87.1	17.47	-135.3	-47.96	89.1	-21.01	-57.4	15.31
3.5	-11.06	-91.1	16.74	-153.1	-46.02	84.8	-22.85	-62.4	13.34
4.0	-10.12	-95.5	16.08	-170.1	-43.10	74.6	-26.20	-74.7	10.11
4.5	-9.47	-97.1	15.85	171.4	-40.92	83.7	-23.61	-88.6	7.92
5.0	-8.18	-105.0	15.64	154.2	-40.00	67.7	-24.01	-105.7	6.98
5.2	-7.68	-107.0	15.80	146.6	-40.00	70.3	-23.22	-106.5	6.70
5.4	-6.84	-110.0	15.92	137.7	-39.17	70.1	-21.94	-114.1	5.73
5.6	-6.02	-116.6	15.95	128.2	-38.42	66.2	-21.62	-129.5	4.95
5.8	-5.50	-122.8	15.99	118.4	-37.72	61.9	-21.83	-137.6	4.35
6.0	-5.29	-131.6	15.89	107.6	-37.72	57.5	-24.15	-149.1	4.33
7.0	-4.07	-176.2	13.91	51.1	-36.48	45.9	-18.56	175.5	3.99
8.0	-6.82	145.9	8.74	1.9	-33.98	9.9	-18.42	156.6	7.11
9.0	-10.75	105.8	3.65	-30.7	-37.08	30.5	-16.42	115.7	20.97
10.0	-14.80	69.1	-1.02	-56.3	-31.37	-7.1	-13.15	94.7	19.14
11.0	-23.35	11.8	-5.80	-79.7	-27.96	-46.2	-11.21	79.5	22.41
12.0	-21.41	1.7	-11.15	-95.8	-40.00	-35.5	-9.76	75.1	160.24
13.0	-14.29	-128.0	-13.94	-100.4	-27.74	-55.3	-8.27	67.8	49.64
14.0	-7.391	170.2	-13.07	-123.0	-21.41	-106.8	-7.41	59.7	17.56
15.0	-5.65	121.1	-13.43	-170.4	-19.33	-159.0	-7.35	52.1	12.69
16.0	-7.45	88.6	-12.92	138.4	-17.14	158.4	-7.33	45.7	10.47
17.0	-13.56	97.3	-11.57	87.6	-15.39	117.3	-7.64	37.3	8.75
18.0	-6.06	130.6	-10.23	31.6	-14.11	66.8	-7.74	31.6	4.98



MGA-665P8 Typical Noise Parameters,  $T_C = 25^\circ\text{C}$ ,  $Z_0 = 50 \Omega$ ,  $V_D = 3 \text{ V}$ ,  $V_C = 0 \text{ V}$ ,  $I_D = 20.5 \text{ mA}$ <sup>[12]</sup>

Freq (GHz)	NFmin (dB)	Gamma Opt			
		Mag	Ang (deg)	Rn @ 50 ohm	NF50 (dB)
0.5	1.48	0.61	26.8	0.61	2.49
1.0	1.27	0.54	32.1	0.35	1.83
1.5	1.10	0.53	42.0	0.30	1.62
2.0	1.08	0.55	44.3	0.31	1.65
2.4	1.18	0.50	53.2	0.29	1.67
2.8	1.24	0.48	61.3	0.27	1.70
3.2	1.32	0.45	69.3	0.24	1.71
3.5	1.36	0.43	75.9	0.23	1.73
4.0	1.45	0.37	88.6	0.20	1.74
4.5	1.50	0.34	97.9	0.18	1.75
5.0	1.46	0.34	102.9	0.16	1.69
5.2	1.42	0.35	107.8	0.15	1.67
5.4	1.42	0.35	111.3	0.14	1.66
5.6	1.40	0.36	114.3	0.13	1.65
5.8	1.40	0.36	120.1	0.13	1.67
6.0	1.46	0.34	128.3	0.13	1.72
7.0	2.08	0.36	148.2	0.11	2.37
8.0	3.35	0.30	176.0	0.14	3.55
9.0	5.50	0.21	-150.6	0.36	5.61
10.0	8.74	0.11	-106.6	1.00	8.77

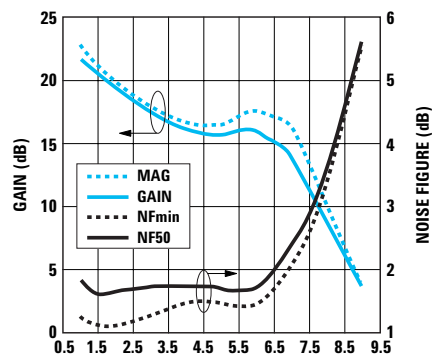

**MGA-665P8 Typical Scattering Parameters,  $T_C = 25^\circ\text{C}$ ,  $Z_0 = 50 \Omega$ ,  $V_D = 3 \text{ V}$ ,  $V_C = 3 \text{ V}$ ,  $I_D = 180 \mu\text{A}$  (OFF State)<sup>[12]</sup>**

Freq (GHz)	S11		S21		S12		S22	
	dB	Ang (deg)	dB	Ang (deg)	dB	Ang (deg)	dB	Ang (deg)
0.1	-0.04	-2.2	-50.46	100.6	-53.98	70.9	-0.09	-1.9
0.5	-0.26	-8.2	-46.02	66.3	-46.02	55.5	-0.10	-8.4
1.0	-0.27	-15.6	-43.10	58.7	-41.94	53.5	-0.26	-17.0
1.5	-0.34	-23.3	-39.17	51.7	-39.17	51.6	-0.54	-25.8
2.0	-0.37	-32.9	-37.08	44.3	-37.08	45.4	-0.91	-33.1
2.2	-0.40	-36.0	-35.92	46.8	-36.48	44.6	-1.05	-36.5
2.4	-0.46	-38.9	-35.92	44.4	-35.39	42.5	-1.19	-40.2
2.6	-0.51	-42.2	-34.89	37.8	-34.89	38.6	-1.36	-43.3
2.8	-0.55	-44.9	-34.42	40.0	-34.42	38.3	-1.55	-47.4
3.0	-0.47	-48.0	-33.15	35.5	-33.98	35.2	-1.81	-50.5
3.5	-0.52	-55.4	-33.56	29.6	-33.15	27.2	-2.27	-58.9
4.0	-0.57	-62.3	-30.17	23.2	-29.90	23.4	-2.95	-65.3
4.5	-0.47	-69.3	-29.37	17.6	-29.63	18.3	-3.56	-75.8
5.0	-0.41	-76.0	-28.18	7.5	-28.40	5.6	-4.17	-80.6
5.2	-0.28	-78.3	-28.40	5.5	-28.18	4.4	-4.25	-83.6
5.4	-0.05	-81.2	-27.54	2.2	-27.74	2.5	-4.39	-87.1
5.6	0.04	-86.1	-27.13	0.5	-26.94	-1.5	-4.67	-90.0
5.8	0.02	-89.6	-26.20	-5.3	-26.38	-5.8	-4.87	-92.6
6.0	-0.48	-94.1	-26.02	-10.3	-26.02	-10.8	-5.26	-95.6
7.0	-1.03	-111.8	-19.58	-46.8	-19.66	-47.2	-6.02	-114.4
8.0	-0.98	-119.5	-28.18	-141.7	-28.40	-142.7	-6.80	-113.8
9.0	-1.77	-137.0	-28.87	-102.7	-26.94	-110.8	-7.19	-130.3
10.0	-1.45	-143.7	-32.04	170.5	-33.15	165.2	-7.90	-150.5
11.0	-1.72	-166.6	-34.89	148.1	-37.72	145.6	-9.09	179.6
12.0	-2.50	173.7	-37.08	97.0	-37.08	105.5	-8.20	166.6
13.0	-2.56	155.8	-24.88	-0.2	-25.04	1.3	-7.23	136.5
14.0	-3.25	145.4	-16.25	-75	-15.97	-74.9	-7.92	120.9
15.0	-2.03	126.4	-15.65	-138.4	-15.55	-137.8	-5.97	112.6
16.0	-2.15	102.9	-13.85	-172.9	-13.94	-172.1	-5.10	95.7
17.0	-4.45	75.0	-10.17	147.1	-10.31	147.6	-5.76	75.8
18.0	-8.45	108.0	-8.64	75.1	-8.68	75.9	-7.92	78.8

**Note:**

12. Measurements are made to the package leads as the reference plane.

## Device Models

Refer to Avago's Web Site [www.Avago.com/view/rf](http://www.Avago.com/view/rf)

### Part Number Ordering Information

Part Number	No. of Devices	Container
MGA-665P8-TR1	3000	7" Reel
MGA-665P8-TR2	10000	13" Reel
MGA-665P8-BLK	100	antistatic bag

### 2x2 LPCC (JEDEC DFP-N) Package Dimensions

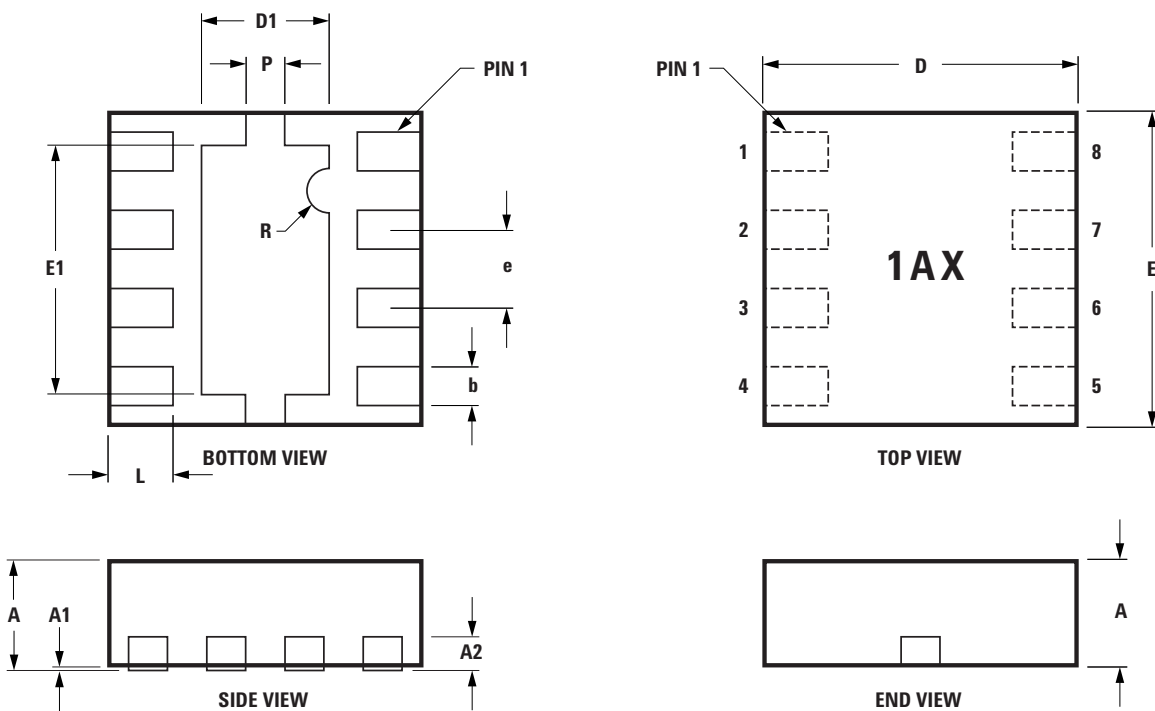

SYMBOL	DIMENSIONS		
	MIN.	NOM.	MAX.
A	0.70	0.75	0.80
A1	0.00	0.02	0.05
A2		0.203 REF	
b	0.225	0.25	0.275
D	1.9	2.0	2.1
D1	0.65	0.80	0.95
E	1.9	2.0	2.1
E1	1.45	1.6	1.75
e		0.50 BSC.	
P	0.2	0.25	0.3
L	0.35	0.4	0.45

NOTE: MEASUREMENTS ARE IN MILLIMETERS.



## Tape Dimensions

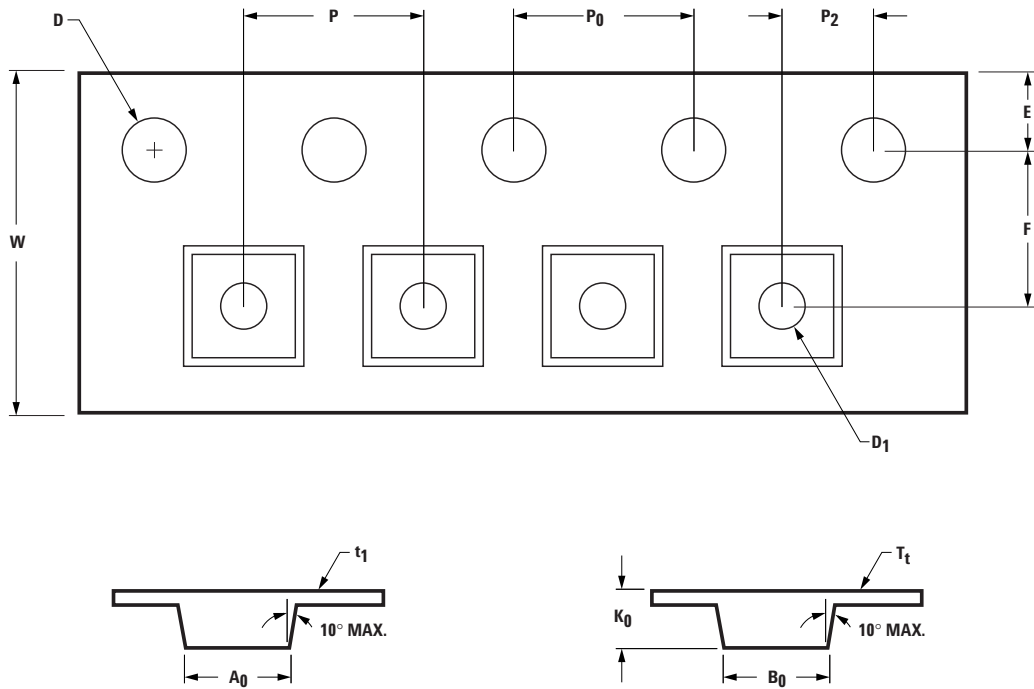

	DESCRIPTION	SYMBOL	SIZE (mm)	SIZE (inch)
CAVITY	LENGTH	A0	2.30 ± 0.05	0.091 ± 0.004
	WIDTH	B0	2.30 ± 0.05	0.091 ± 0.004
	DEPTH	K0	1.00 ± 0.05	0.039 ± 0.002
	PITCH	P	4.00 ± 0.10	0.157 ± 0.004
	BOTTOM HOLE DIAMETER	D1	1.00 ± 0.25	0.039 ± 0.002
PERFORATION	DIAMETER	D	1.50 ± 0.10	0.060 ± 0.004
	PITCH	P0	4.00 ± 0.10	0.157 ± 0.004
	POSITION	E	1.75 ± 0.10	0.069 ± 0.004
CARRIER TAPE	WIDTH	W	8.00 + 0.30 8.00 - 0.10	0.315 ± 0.012 0.315 ± 0.004
	THICKNESS	t1	0.254 ± 0.02	0.010 ± 0.0008
	COVER TAPE	WIDTH	C	5.4 ± 0.10
	TAPE THICKNESS	Tt	0.062 ± 0.001	0.0025 ± 0.0004
DISTANCE	CAVITY TO PERFORATION (WIDTH DIRECTION)	F	3.50 ± 0.05	0.138 ± 0.002
	CAVITY TO PERFORATION (LENGTH DIRECTION)	P2	2.00 ± 0.05	0.079 ± 0.002

For product information and a complete list of distributors, please go to our website: [www.avagotech.com](http://www.avagotech.com)

Avago, Avago Technologies, and the A logo are trademarks of Avago Technologies in the United States and other countries.  
Data subject to change. Copyright © 2005-2008 Avago Technologies. All rights reserved. Obsoletes 5989-2314EN  
AV02-0847EN - August 26, 2008

**Avago**  
TECHNOLOGIES

# Mouser Electronics

Authorized Distributor

Click to View Pricing, Inventory, Delivery & Lifecycle Information:

[Avago Technologies:](#)

[MGA-665P8-BLK](#)