

Features

- Epitaxial Planar Die Construction
- Complementary NPN Type Available (DZT2222A)
- Ideally Suited for Automated Assembly Processes
- Ideal for Medium Power Amplification and Switching
- **Lead Free By Design/RoHS Compliant (Note 1)**
- **"Green" Device (Note 2)**

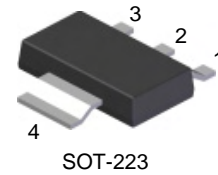

Mechanical Data

- Case: SOT-223
- Case Material: Molded Plastic, "Green" Molding Compound. UL Flammability Classification Rating 94V-0
- Moisture Sensitivity: Level 1 per J-STD-020C
- Terminals: Finish - Matte Tin annealed over Copper Leadframe (Lead Free Plating). Solderable per MIL-STD-202, Method 208
- Marking & Type Code Information: See Page 4
- Ordering Information: See Page 4
- Weight: 0.115 grams (approximate)

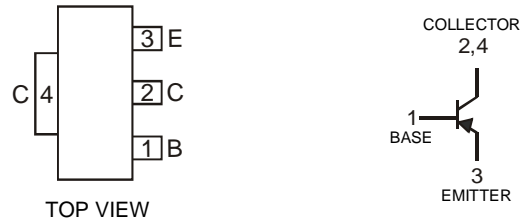

Schematic and Pin Configuration

Maximum Ratings @T_A = 25°C unless otherwise specified

Characteristic	Symbol	Value	Unit
Collector-Base Voltage	V _{CB0}	-60	V
Collector-Emitter Voltage	V _{CE0}	-60	V
Emitter-Base Voltage	V _{EBO}	-5	V
Collector Continuous Current (Note 3)	I _C	-600	mA
Peak Collector Current	I _{CM}	-800	mA

Thermal Characteristics

Characteristic	Symbol	Value	Unit
Power Dissipation @ T _A = 25°C	P _d	1000 (Note 3)	mW
		1500 (Note 4)	
Power Derating Factor above 25°C (Note 4)	P _{der}	12	mW/°C
Operating and Storage Temperature Range	T _j , T _{STG}	-55 to +150	°C
Thermal Resistance, Junction to Ambient Air @ T _A = 25°C (Note 4)	R _{θJA}	83.3	°C/W

- Notes:
1. No purposefully added lead.
 2. Diodes Inc.'s "Green" policy can be found on our website at http://www.diodes.com/products/lead_free/index.php.
 3. Device mounted on 2" x 2" FR-4 PC board, 2 oz. copper, single sided, pad layout as shown on page 4, or on Diodes Inc. suggested pad layout document AP02001, which can be found on our website at <http://www.diodes.com/datasheets/ap02001.pdf>.
 4. Device mounted on FR-4 PCB, 7cm² of copper pad area.

Electrical Characteristics @T_A = 25°C unless otherwise specified

Characteristic	Symbol	Min	Max	Unit	Test Conditions
OFF CHARACTERISTICS (Note 5)					
Collector-Base Cutoff Current	I _{CB0}	—	-0.01	μA	V _{CB} = -50V, I _E = 0
		—	-10		V _{CB} = -50V, I _E = 0, T _A = 150°C
Collector Cutoff Current	I _{CEX}	—	-50	nA	V _{CE} = -30V, V _{EB(OFF)} = -0.5V
Base Cutoff Current	I _{BL}	—	-50	nA	V _{CE} = -30V, V _{EB(OFF)} = -0.5V
Collector-Base Breakdown Voltage	V _{(BR)CBO}	-60	—	V	I _C = -10 μA, I _E = 0
Collector-Emitter Breakdown Voltage	V _{(BR)CEO}	-60	—	V	I _C = -10 mA, I _B = 0
Emitter-Base Breakdown Voltage	V _{(BR)EBO}	-5	—	V	I _E = -10 μA, I _C = 0
ON CHARACTERISTICS (Note 5)					
Collector-Emitter Saturation Voltage	V _{CE(SAT)}	—	-0.4	V	I _C = -150mA, I _B = -15mA
		—	-1.6	V	I _C = -500mA, I _B = -50mA
DC Current Gain	h _{FE}	75	—	—	V _{CE} = -10V, I _C = -100μA
		100	—	—	V _{CE} = -10V, I _C = -1mA
		100	—	—	V _{CE} = -10V, I _C = -10mA
		100	300	—	V _{CE} = -10V, I _C = -150mA
		50	—	—	V _{CE} = -10V, I _C = -500mA
Base-Emitter Saturation Voltage	V _{BE(SAT)}	—	-1.3	V	I _C = -150mA, I _B = -15mA
		—	-2.6	V	I _C = -500mA, I _B = -50mA
SMALL SIGNAL CHARACTERISTICS					
Current Gain-Bandwidth Product	f _T	200	—	MHz	V _{CE} = -20V, I _C = -50mA, f = 100MHz
Output Capacitance	C _{obo}	—	8	pF	V _{CB} = -10V, I _E = 0A, f = 1MHz
Input Capacitance	C _{ibo}	—	30	pF	V _{EB} = -2V, I _C = 0A, f = 1MHz
SWITCHING CHARACTERISTICS					
Turn-On Time	t _{on}	—	45	ns	V _{CC} = -30V, I _C = -150mA, I _{B1} = -15mA
Delay Time	t _d	—	10	ns	
Rise Time	t _r	—	40	ns	
Turn-Off Time	t _{off}	—	100	ns	V _{CC} = -6V, I _C = -150mA, I _{B1} = I _{B2} = -15mA
Storage Time	t _s	—	80	ns	
Fall Time	t _f	—	30	ns	

Notes: 5. Pulse Test: Pulse width, tp < 300 μs, Duty Cycle, d < 0.02

Typical Characteristics @T_A = 25°C unless otherwise specified

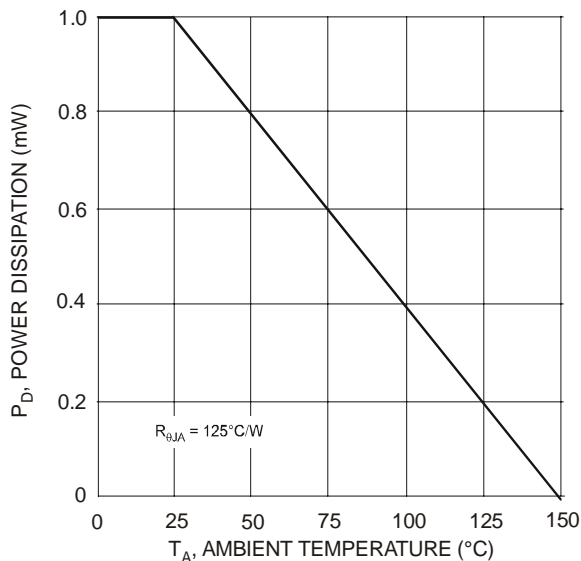

Fig. 1 Power Dissipation vs. Ambient Temperature (Note 3)

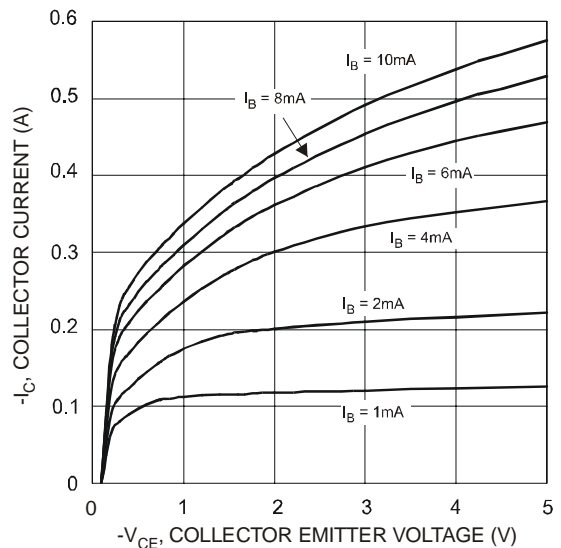

Fig. 2 Typical Collector Current as a Function of Collector Emitter Voltage

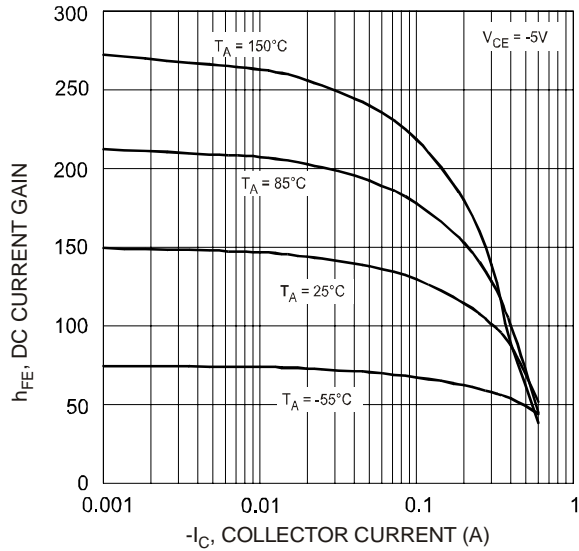

Fig. 3 Typical DC Current Gain vs. Collector Current

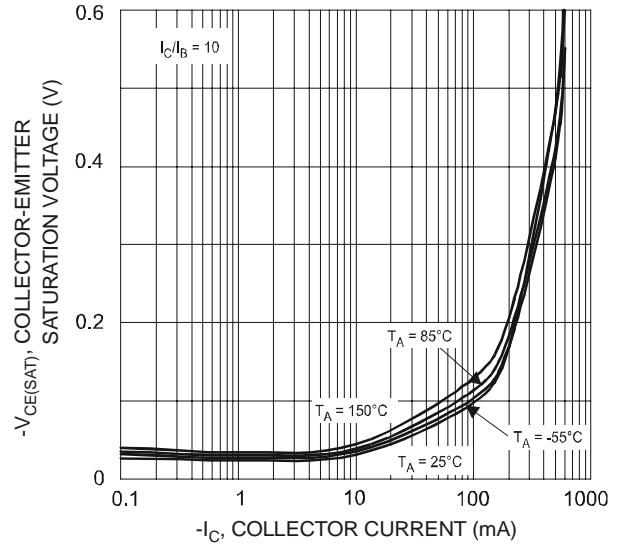

Fig. 4 Typical Collector-Emitter Saturation Voltage vs. Collector Current

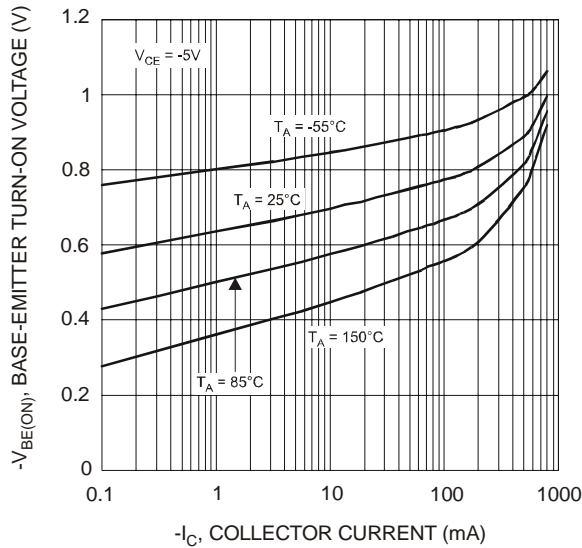

Fig. 5 Typical Base-Emitter Turn-On Voltage vs. Collector Current

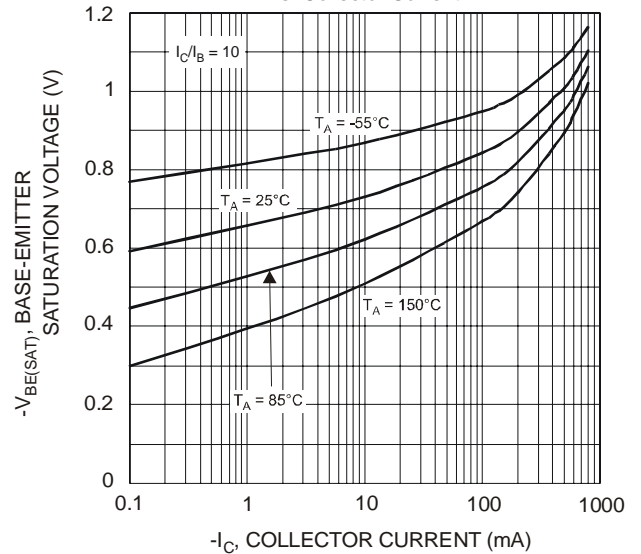

Fig. 6 Typical Base-Emitter Saturation Voltage vs. Collector Current

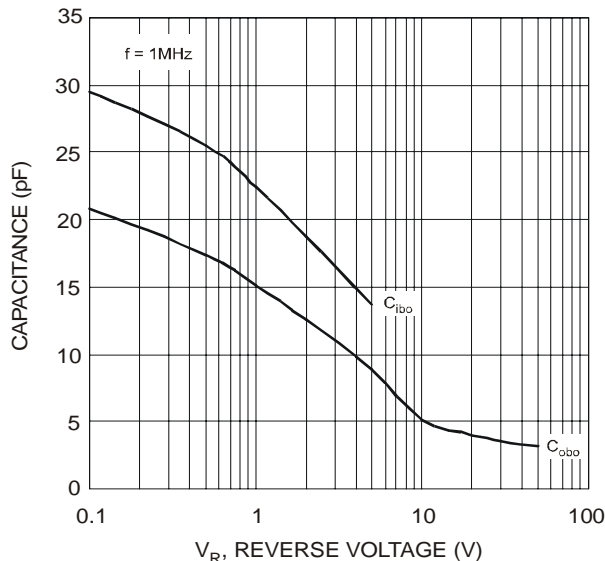

Fig. 7 Typical Capacitance Characteristics

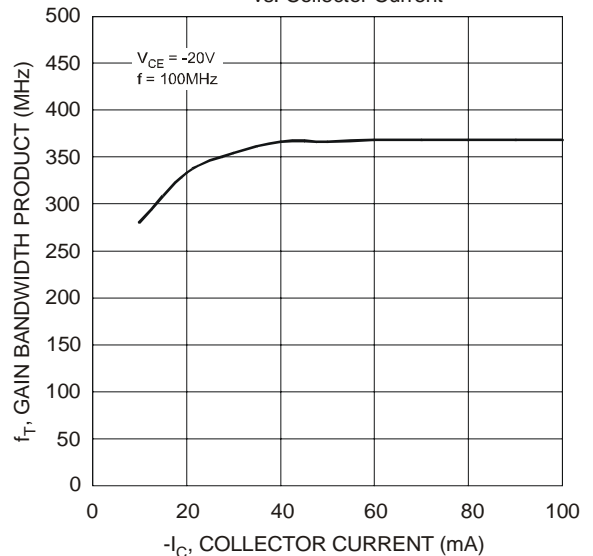

Fig. 8 Typical Gain-Bandwidth Product vs. Collector Current

Ordering Information (Note 6)

Device	Packaging	Shipping
DZT2907A-13	SOT-223	2500/Tape & Reel

Notes: 6. For packaging details, go to our website at <http://www.diodes.com/datasheets/ap02007.pdf>.

Marking Information

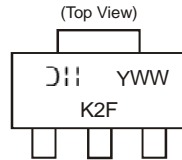

D = Manufacturer's code marking
K2F = Product type marking code
YWW = Date code marking
Y = Last digit of year ex: 7 = 2007
WW = Week code 01 - 52

Package Outline Dimensions

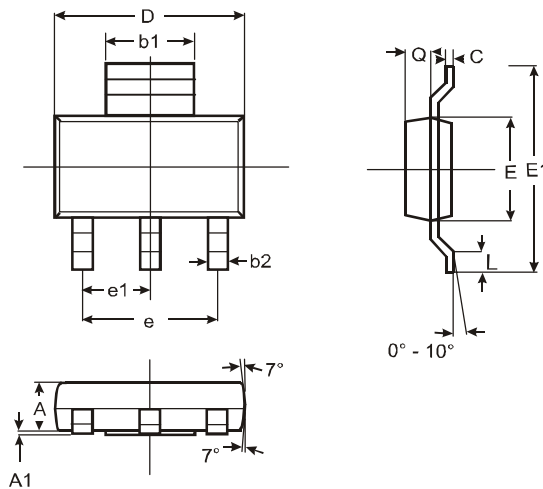

SOT-223			
Dim	Min	Max	Typ
A	1.55	1.65	1.60
A1	0.010	0.15	0.05
b1	2.90	3.10	3.00
b2	0.60	0.80	0.70
C	0.20	0.30	0.25
D	6.45	6.55	6.50
E	3.45	3.55	3.50
E1	6.90	7.10	7.00
e	—	—	4.60
e1	—	—	2.30
L	0.85	1.05	0.95
Q	0.84	0.94	0.89
All Dimensions in mm			

Suggested Pad Layout: (Based on IPC-SM-782)

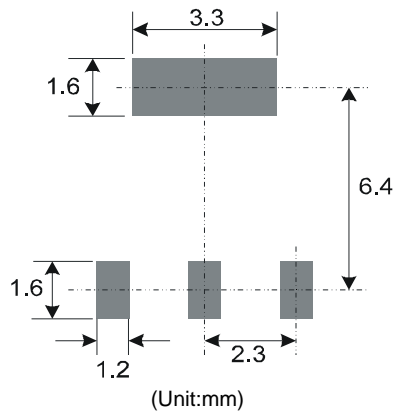

IMPORTANT NOTICE

Diodes Incorporated and its subsidiaries reserve the right to make modifications, enhancements, improvements, corrections or other changes without further notice to any product herein. Diodes Incorporated does not assume any liability arising out of the application or use of any product described herein; neither does it convey any license under its patent rights, nor the rights of others. The user of products in such applications shall assume all risks of such use and will agree to hold Diodes Incorporated and all the companies whose products are represented on our website, harmless against all damages.

LIFE SUPPORT

Diodes Incorporated products are not authorized for use as critical components in life support devices or systems without the expressed written approval of the President of Diodes Incorporated.

Mouser Electronics

Authorized Distributor

Click to View Pricing, Inventory, Delivery & Lifecycle Information:

[Diodes Incorporated:](#)

[DZT2907A-13](#)