



FDMB2307NZ

Dual Common Drain N-Channel PowerTrench[®] MOSFET 20 V, 9.7 A, 16.5 mΩ

Features

- Max $r_{S1S2(on)}$ = 16.5 mΩ at $V_{GS} = 4.5$ V, $I_D = 8$ A
- Max $r_{S1S2(on)}$ = 18 mΩ at $V_{GS} = 4.2$ V, $I_D = 7.4$ A
- Max $r_{S1S2(on)}$ = 21 mΩ at $V_{GS} = 3.1$ V, $I_D = 7$ A
- Max $r_{S1S2(on)}$ = 24 mΩ at $V_{GS} = 2.5$ V, $I_D = 6.7$ A
- Low Profile - 0.8 mm maximum - in the new package MicroFET 2x3 mm
- HBM ESD protection level > 2 kV (Note 3)
- RoHS Compliant



General Description

This device is designed specifically as a single package solution for Li-Ion battery pack protection circuit and other ultra-portable applications. It features two common drain N-channel MOSFETs, which enables bidirectional current flow, on Fairchild's advanced PowerTrench[®] process with state of the art MicroFET Leadframe, the FDMB2307NZ minimizes both PCB space and $r_{S1S2(on)}$.

Application

- Li-Ion Battery Pack

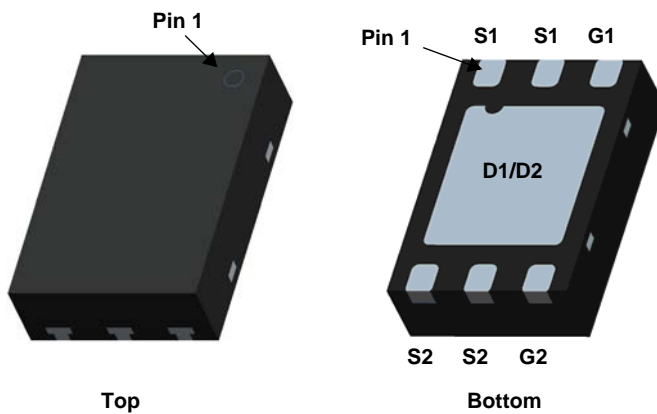

MLP 2x3

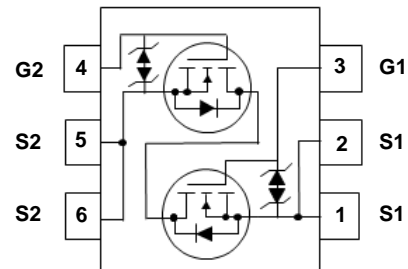

MOSFET Maximum Ratings $T_A = 25^\circ\text{C}$ unless otherwise noted

Symbol	Parameter	Conditions	Rating	Units
V_{S1S2}	Source1 to Source2 Voltage		20	V
V_{GS}	Gate to Source Voltage	(Note 4)	± 12	V
I_{S1S2}	Source1 to Source2 Current	-Continuous $T_A = 25^\circ\text{C}$	9.7	A
		-Pulsed	40	
P_D	Power Dissipation	$T_A = 25^\circ\text{C}$ (Note 1a)	2.2	W
	Power Dissipation	$T_A = 25^\circ\text{C}$ (Note 1b)	0.8	
T_J, T_{STG}	Operating and Storage Junction Temperature Range		-55 to +150	$^\circ\text{C}$

Thermal Characteristics

$R_{\theta JA}$	Thermal Resistance, Junction to Ambient(Dual Operation)	(Note 1a)	57	$^\circ\text{C/W}$
$R_{\theta JA}$	Thermal Resistance, Junction to Ambient(Dual Operation)	(Note 1b)	161	

Package Marking and Ordering Information

Device Marking	Device	Package	Reel Size	Tape Width	Quantity
307	FDMB2307NZ	MLP 2x3	7"	8 mm	3000 units

Electrical Characteristics $T_J = 25^\circ\text{C}$ unless otherwise noted

Symbol	Parameter	Test Conditions	Min	Typ	Max	Units
--------	-----------	-----------------	-----	-----	-----	-------

Off Characteristics

I_{S1S2}	Zero Gate Voltage Source1 to Source2 Current	$V_{S1S2} = 16\text{ V}, V_{GS} = 0\text{ V}$			1	μA
I_{GSS}	Gate to Source Leakage Current	$V_{GS} = 12\text{ V}, V_{S1S2} = 0\text{ V}$			10	μA

On Characteristics

$V_{GS(th)}$	Gate to Source Threshold Voltage	$V_{GS} = V_{S1S2}, I_{S1S2} = 250\ \mu\text{A}$	0.6	1	1.5	V
$r_{S1S2(on)}$	Static Source1 to Source2 On Resistance	$V_{GS} = 4.5\text{ V}, I_{S1S2} = 8\text{ A}$	10.5	13.5	16.5	m Ω
		$V_{GS} = 4.2\text{ V}, I_{S1S2} = 7.4\text{ A}$	11	14	18	
		$V_{GS} = 3.1\text{ V}, I_{S1S2} = 7\text{ A}$	11.5	16	21	
		$V_{GS} = 2.5\text{ V}, I_{S1S2} = 6.7\text{ A}$	12	18	24	
		$V_{GS} = 4.5\text{ V}, I_{S1S2} = 8\text{ A}, T_J = 125^\circ\text{C}$	11	20	29	
g_{FS}	Forward Transconductance	$V_{S1S2} = 5\text{ V}, I_{S1S2} = 8\text{ A}$		41		S

Dynamic Characteristics

C_{iss}	Input Capacitance	$V_{S1S2} = 10\text{ V}, V_{GS} = 0\text{ V}, f = 1\text{ MHz}$		1760	2640	pF
C_{oss}	Output Capacitance			229	345	pF
C_{rss}	Reverse Transfer Capacitance			211	320	pF
R_g	Gate Resistance (Note 5)		0.1	2.6	8	Ω

Switching Characteristics

$t_{d(on)}$	Turn-On Delay Time	$V_{S1S2} = 10\text{ V}, I_{S1S2} = 8\text{ A}, V_{GS} = 4.5\text{ V}, R_{GEN} = 6\ \Omega$		12	22	ns
t_r	Rise Time			19	34	ns
$t_{d(off)}$	Turn-Off Delay Time			32	51	ns
t_f	Fall Time			9.5	17	ns
Q_g	Total Gate Charge		$V_{G1S1} = 0\text{ V to } 5\text{ V}$		20	28
Q_g	Total Gate Charge	$V_{G1S1} = 0\text{ V to } 4.5\text{ V}$		18	25	nC
Q_{gs}	Gate1 to Source1 Charge	$V_{S1S2} = 10\text{ V}, I_{S1S2} = 8\text{ A}, V_{G2S2} = 0\text{ V}$		2.8		nC
Q_{gd}	Gate1 to Source2 "Miller" Charge			5.3		nC

Source1- Source2 Diode Characteristics

I_{fss}	Maximum Continuous Source1-Source2 Diode Forward Current			8	A	
V_{fss}	Source1 to Source2 Diode Forward Voltage	$V_{G1S1} = 0\text{ V}, V_{G2S2} = 4.5\text{ V}, I_{fss} = 8\text{ A}$ (Note 2)		0.8	1.2	V

NOTES:

- $R_{\theta JA}$ is determined with the device mounted on a 1 in² pad 2 oz copper pad on a 1.5 x 1.5 in. board of FR-4 material. $R_{\theta JC}$ is guaranteed by design while $R_{\theta CA}$ is determined by the user's board design.



a. 57 °C/W when mounted on a 1 in² pad of 2 oz copper

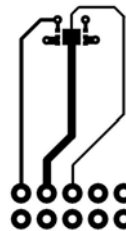

b. 161 °C/W when mounted on a minimum pad of 2 oz copper

- Pulse Test: Pulse Width < 300 μs , Duty cycle < 2.0%.
- The diode connected between the gate and source serves only as protection against ESD. No gate overvoltage rating is implied.
- As an N-ch device, the negative V_{gs} rating is for low duty cycle pulse occurrence only. No continuous rating is implied.
- R_g is measured on 100% of the die at wafer level.

Typical Characteristics $T_J = 25^\circ\text{C}$ unless otherwise noted

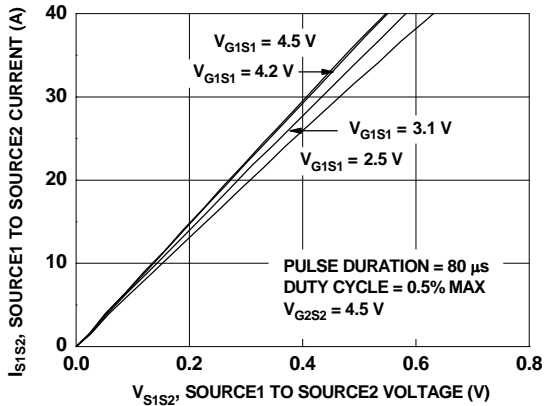

Figure 1. On-Region Characteristics

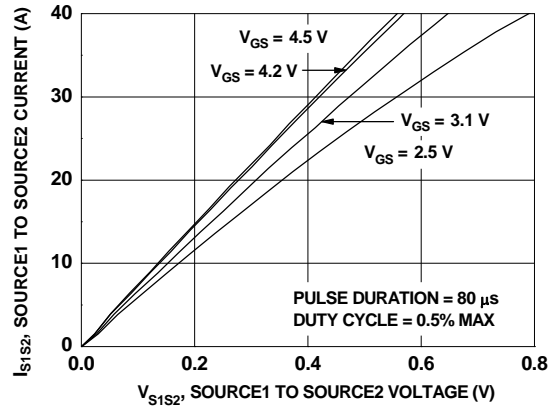

Figure 2. On-Region Characteristics

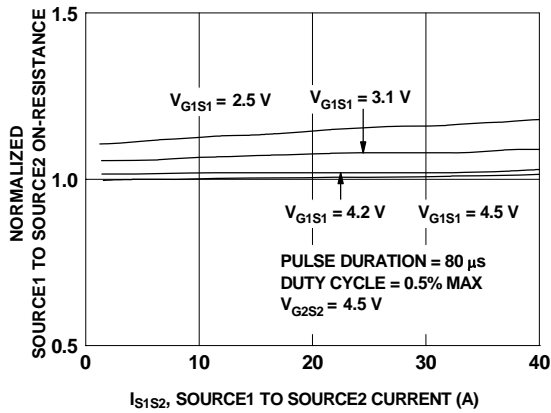

Figure 3. Normalized On-Resistance vs Source1 to Source2 Current and Gate Voltage

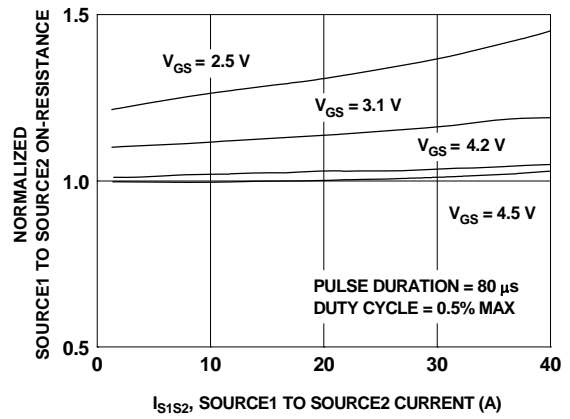

Figure 4. Normalized On-Resistance vs Source1 to Source2 Current and Gate Voltage

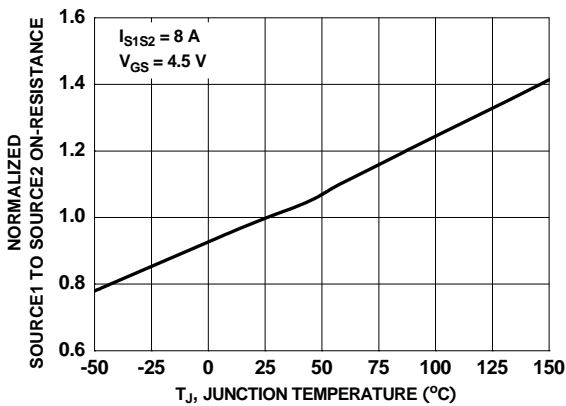

Figure 5. Normalized On Resistance vs Junction Temperature

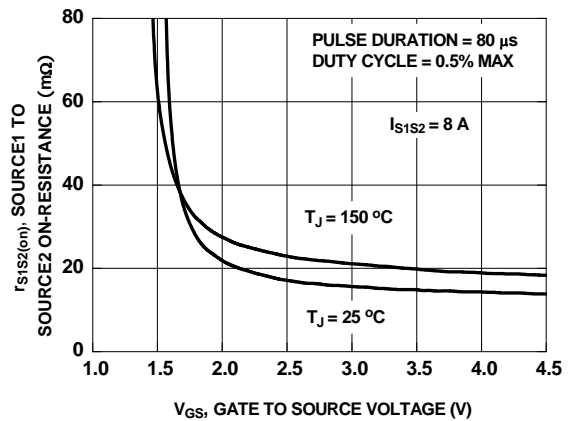

Figure 6. On Resistance vs Gate to Source Voltage

Typical Characteristics $T_J = 25^\circ\text{C}$ unless otherwise noted

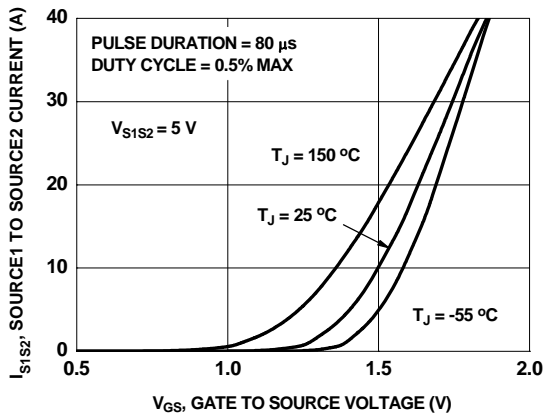

Figure 7. Transfer Characteristics

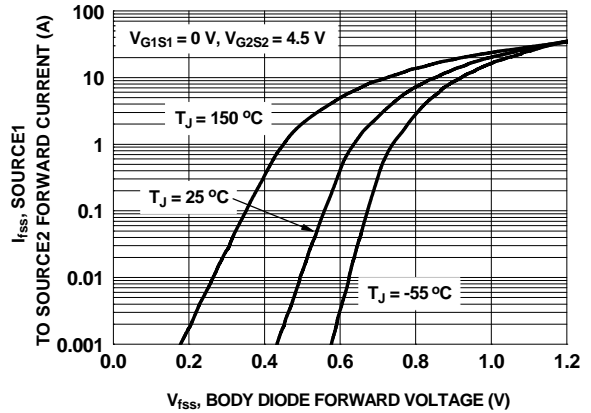

Figure 8. Source1 to Source2 Diode Forward Voltage vs Source Current

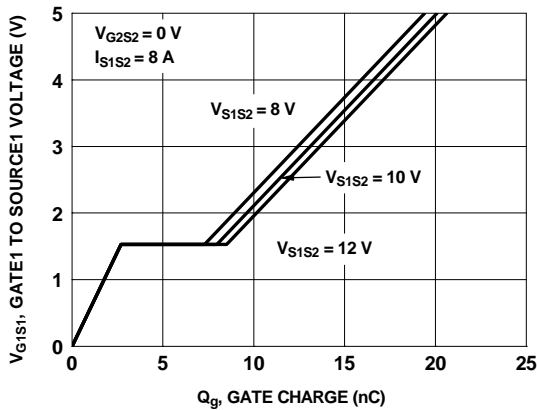

Figure 9. Gate Charge Characteristics

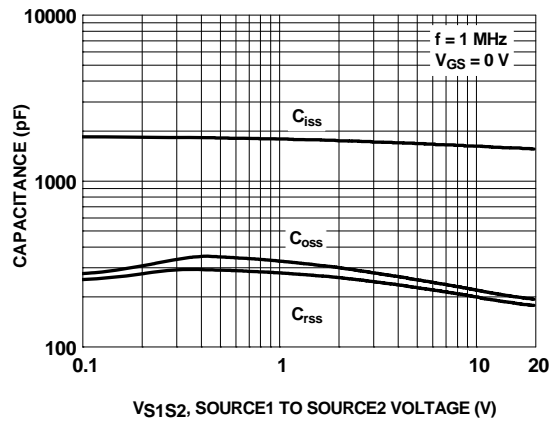

Figure 10. Capacitance vs Source1 to Source2 Voltage

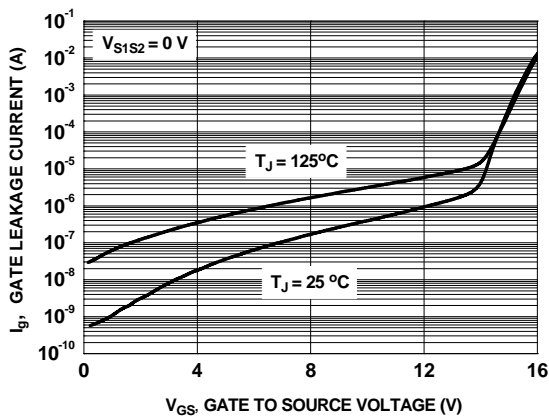

Figure 11. Gate Leakage Current vs Gate to Source Voltage

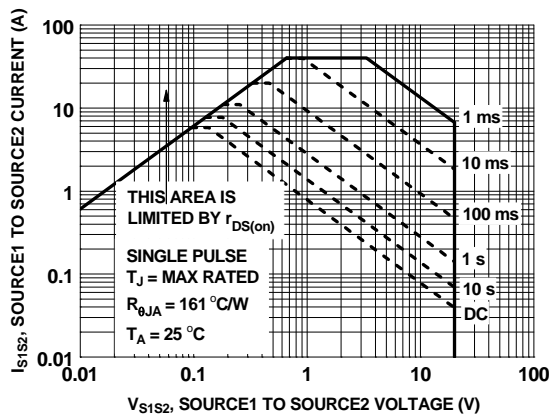

Figure 12. Forward Bias Safe Operating Area

Typical Characteristics $T_J = 25^\circ\text{C}$ unless otherwise noted

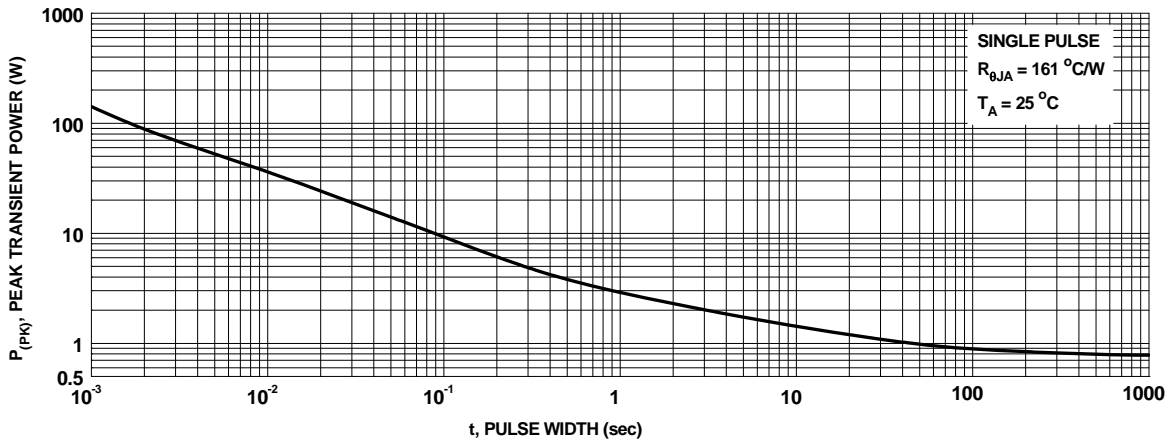

Figure 13. Single Pulse Maximum Power Dissipation

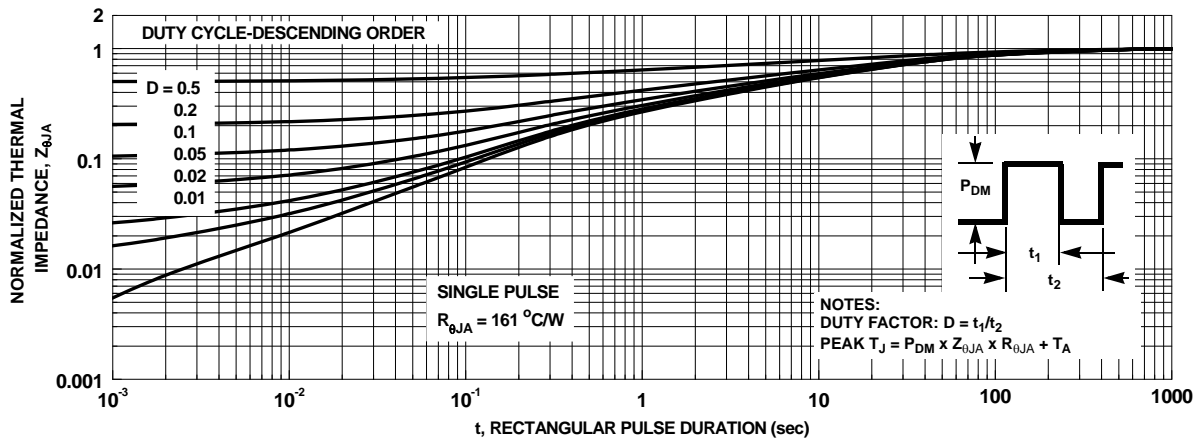
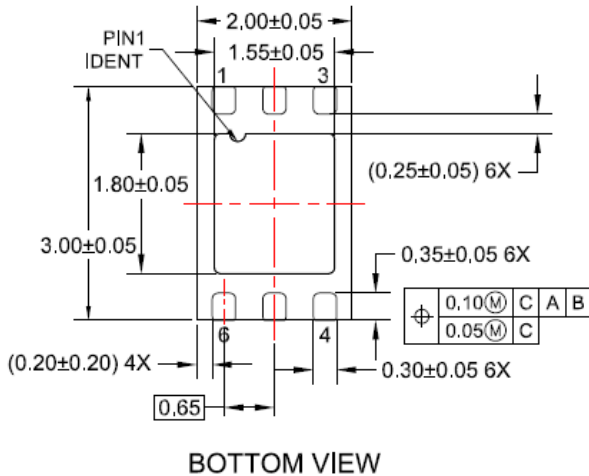
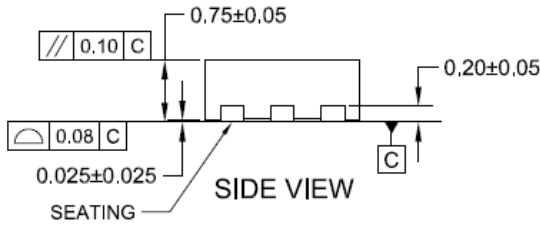
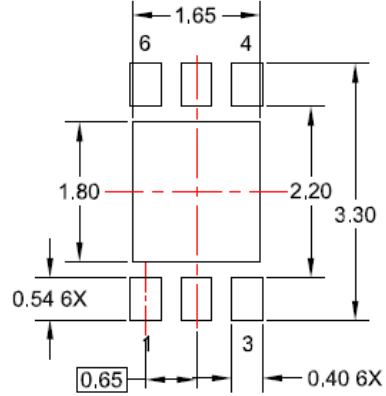
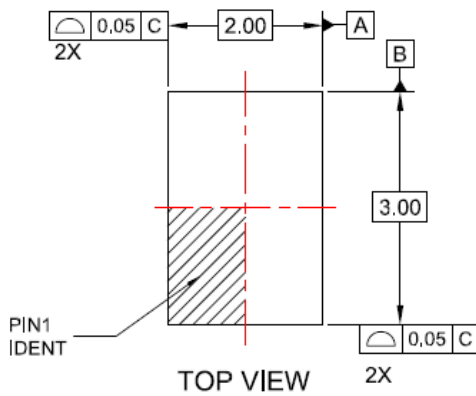

Figure 14. Junction-to-Ambient Transient Thermal Response Curve

Dimensional Outline and Pad Layout



NOTES:

- A. PACKAGE CONFORMS TO JEDEC MO-229 EXCEPT WHERE NOTED.
- B. DRAWING FILENAME: MKT-MLP06Qrev3.
- C. DIMENSIONS AND TOLERANCES PER ASME Y14.5M, 2009.
- D. LAND PATTERN RECOMMENDATION IS EXISTING INDUSTRY LAND PATTERN.
- E. DIMENSIONS ARE IN MILLIMETERS.
- F. REFERENCE DIMENSIONS ARE UNCONTROLLED







Package drawings are provided as a service to customers considering Fairchild components. Drawings may change in any manner without notice. Please note the revision and/or date on the drawing and contact a Fairchild Semiconductor representative to verify or obtain the most recent revision. Package specifications do not expand the terms of Fairchild's worldwide terms and conditions, specifically the warranty therein, which covers Fairchild products.

Always visit Fairchild Semiconductor's online packaging area for the most recent package drawings:
http://www.fairchildsemi.com/package/packageDetails.html?id=PN_MLDEA-C06.



TRADEMARKS

The following includes registered and unregistered trademarks and service marks, owned by Fairchild Semiconductor and/or its global subsidiaries, and is not intended to be an exhaustive list of all such trademarks.

- | | | | |
|---|---|---|---|
| AccuPower™ | F-PFS™ |  | SYSTEM GENERAL® |
| AX-CAP®* | FRFET® | PowerTrench® | TinyBoost® |
| BitSiC™ | Global Power ResourceSM | PowerXS™ | TinyBuck™ |
| Build it Now™ | GreenBridge™ | Programmable Active Droop™ | TinyCalc™ |
| CorePLUS™ | Green FPS™ | QFET® | TinyLogic® |
| CorePOWER™ | Green FPS™ e-Series™ | QS™ | TINYOPTO™ |
| CROSSVOLT™ | Gmax™ | Quiet Series™ | TinyPower™ |
| CTL™ | GTO™ | RapidConfig™ | TinyPWM™ |
| Current Transfer Logic™ | IntelliMAX™ |  | TinyWire™ |
| DEUXPEED® | ISOPLANAR™ | Saving our world, 1mW/W/kW at a time™ | TranSiC™ |
| Dual Cool™ | Marking Small Speakers Sound Louder and Better™ | SignalWise™ | TriFault Detect™ |
| EcoSPARK® | MegaBuck™ | SmartMax™ | TRUECURRENT®* |
| EfficientMax™ | MICROCOUPLER™ | SMART START™ | µSerDes™ |
| ESBC™ | MicroFET™ | Solutions for Your Success™ |  |
|  | MicroPak™ | SPM® | UHC® |
| Fairchild® | MicroPak2™ | STEALTH™ | Ultra FRFET™ |
| Fairchild Semiconductor® | MillerDrive™ | SuperFET® | UniFET™ |
| FACT Quiet Series™ | MotionMax™ | SuperSOT™-3 | VCX™ |
| FACT® | mWSaver® | SuperSOT™-6 | VisualMax™ |
| FAST® | OptoHit™ | SuperSOT™-8 | VoltagePlus™ |
| FastvCore™ | OPTOLOGIC® | SupreMOS® | XST™ |
| FETBench™ | OPTOPLANAR® | SyncFET™ | 仙童™ |
| FPS™ | | Sync-Lock™ | |

*Trademarks of System General Corporation, used under license by Fairchild Semiconductor.

DISCLAIMER

FAIRCHILD SEMICONDUCTOR RESERVES THE RIGHT TO MAKE CHANGES WITHOUT FURTHER NOTICE TO ANY PRODUCTS HEREIN TO IMPROVE RELIABILITY, FUNCTION, OR DESIGN. FAIRCHILD DOES NOT ASSUME ANY LIABILITY ARISING OUT OF THE APPLICATION OR USE OF ANY PRODUCT OR CIRCUIT DESCRIBED HEREIN; NEITHER DOES IT CONVEY ANY LICENSE UNDER ITS PATENT RIGHTS, NOR THE RIGHTS OF OTHERS. THESE SPECIFICATIONS DO NOT EXPAND THE TERMS OF FAIRCHILD'S WORLDWIDE TERMS AND CONDITIONS, SPECIFICALLY THE WARRANTY THEREIN, WHICH COVERS THESE PRODUCTS.

LIFE SUPPORT POLICY

FAIRCHILD'S PRODUCTS ARE NOT AUTHORIZED FOR USE AS CRITICAL COMPONENTS IN LIFE SUPPORT DEVICES OR SYSTEMS WITHOUT THE EXPRESS WRITTEN APPROVAL OF FAIRCHILD SEMICONDUCTOR CORPORATION.

As used here in:

- Life support devices or systems are devices or systems which, (a) are intended for surgical implant into the body or (b) support or sustain life, and (c) whose failure to perform when properly used in accordance with instructions for use provided in the labeling, can be reasonably expected to result in a significant injury of the user.
- A critical component in any component of a life support, device, or system whose failure to perform can be reasonably expected to cause the failure of the life support device or system, or to affect its safety or effectiveness.

ANTI-COUNTERFEITING POLICY

Fairchild Semiconductor Corporation's Anti-Counterfeiting Policy. Fairchild's Anti-Counterfeiting Policy is also stated on our external website, www.Fairchildsemi.com, under Sales Support.

Counterfeiting of semiconductor parts is a growing problem in the industry. All manufactures of semiconductor products are experiencing counterfeiting of their parts. Customers who inadvertently purchase counterfeit parts experience many problems such as loss of brand reputation, substandard performance, failed application, and increased cost of production and manufacturing delays. Fairchild is taking strong measures to protect ourselves and our customers from the proliferation of counterfeit parts. Fairchild strongly encourages customers to purchase Fairchild parts either directly from Fairchild or from Authorized Fairchild Distributors who are listed by country on our web page cited above. Products customers buy either from Fairchild directly or from Authorized Fairchild Distributors are genuine parts, have full traceability, meet Fairchild's quality standards for handling and storage and provide access to Fairchild's full range of up-to-date technical and product information. Fairchild and our Authorized Distributors will stand behind all warranties and will appropriately address and warranty issues that may arise. Fairchild will not provide any warranty coverage or other assistance for parts bought from Unauthorized Sources. Fairchild is committed to combat this global problem and encourage our customers to do their part in stopping this practice by buying direct or from authorized distributors.

PRODUCT STATUS DEFINITIONS

Definition of Terms

Datasheet Identification	Product Status	Definition
Advance Information	Formative / In Design	Datasheet contains the design specifications for product development. Specifications may change in any manner without notice.
Preliminary	First Production	Datasheet contains preliminary data; supplementary data will be published at a later date. Fairchild Semiconductor reserves the right to make changes at any time without notice to improve design.
No Identification Needed	Full Production	Datasheet contains final specifications. Fairchild Semiconductor reserves the right to make changes at any time without notice to improve the design.
Obsolete	Not In Production	Datasheet contains specifications on a product that is discontinued by Fairchild Semiconductor. The datasheet is for reference information only.

Mouser Electronics

Authorized Distributor

Click to View Pricing, Inventory, Delivery & Lifecycle Information:

[Fairchild Semiconductor:](#)

[FDMB2307NZ](#)