



March 2016

FDMS9408_F085

N-Channel PowerTrench[®] MOSFET

40 V, 80 A, 1.8 mΩ

Features

- Typical $R_{DS(on)}$ = 1.5 mΩ at $V_{GS} = 10V$, $I_D = 80 A$
- Typical $Q_{g(tot)}$ = 68 nC at $V_{GS} = 10V$, $I_D = 80 A$
- UIS Capability
- RoHS Compliant
- Qualified to AEC Q101

Applications

- Automotive Engine Control
- PowerTrain Management
- Solenoid and Motor Drivers
- Integrated Starter/Alternator
- Primary Switch for 12V Systems

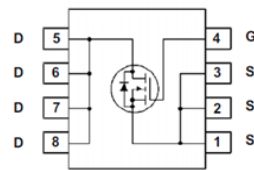
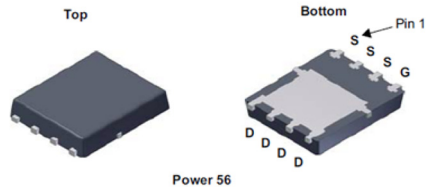

For current package drawing, please refer to the Fairchild website at <https://www.fairchildsemi.com/package-drawings/PQ/PQFN08M.pdf>

MOSFET Maximum Ratings $T_J = 25^\circ C$ unless otherwise noted.

| Symbol | Parameter | Conditions | Rated Values | Units |
|-----------------|---|--------------------|--------------|---------------|
| V_{DSS} | Drain-to-Source Voltage | | 40 | V |
| V_{GS} | Gate-to-Source Voltage | | ± 20 | V |
| I_D | Drain Current - Continuous ($V_{GS}=10$) (Note 1) | $T_C = 25^\circ C$ | 80 | A |
| | Pulsed Drain Current | $T_C = 25^\circ C$ | See Figure 4 | |
| E_{AS} | Single Pulse Avalanche Energy | (Note 2) | 143 | mJ |
| P_D | Power Dissipation | | 214 | W |
| | Derate Above $25^\circ C$ | | 1.43 | W/ $^\circ C$ |
| T_J, T_{STG} | Operating and Storage Temperature | | -55 to + 175 | $^\circ C$ |
| $R_{\theta JC}$ | Thermal Resistance, Junction to Case | | 0.7 | $^\circ C/W$ |
| $R_{\theta JA}$ | Maximum Thermal Resistance, Junction to Ambient | (Note 3) | 50 | $^\circ C/W$ |

Notes:

- 1: Current is limited by bondwire configuration.
- 2: Starting $T_J = 25^\circ C$, $L = 70\mu H$, $I_{AS} = 64A$, $V_{DD} = 40V$ during inductor charging and $V_{DD} = 0V$ during time in avalanche.
- 3: $R_{\theta JA}$ is the sum of the junction-to-case and case-to-ambient thermal resistance, where the case thermal reference is defined as the solder mounting surface of the drain pins. $R_{\theta JC}$ is guaranteed by design, while $R_{\theta JA}$ is determined by the board design. The maximum rating presented here is based on mounting on a 1 in² pad of 2oz copper.

Package Marking and Ordering Information

| Device Marking | Device | Package | Reel Size | Tape Width | Quantity |
|----------------|---------------|---------|-----------|------------|-----------|
| FDMS9408 | FDMS9408_F085 | Power56 | 13" | 12mm | 3000units |

FDMS9408_F085 N-Channel PowerTrench[®] MOSFET

Electrical Characteristics $T_J = 25^\circ\text{C}$ unless otherwise noted.

| Symbol | Parameter | Test Conditions | Min. | Typ. | Max. | Units |
|--------|-----------|-----------------|------|------|------|-------|
|--------|-----------|-----------------|------|------|------|-------|

Off Characteristics

| | | | | | | |
|--------------|-----------------------------------|---|----|---|-----------|---------------|
| $B_{V_{DS}}$ | Drain-to-Source Breakdown Voltage | $I_D = 250\mu\text{A}$, $V_{GS} = 0\text{V}$ | 40 | - | - | V |
| I_{DSS} | Drain-to-Source Leakage Current | $V_{DS} = 40\text{V}$, $T_J = 25^\circ\text{C}$ $V_{GS} = 0\text{V}$, $T_J = 175^\circ\text{C}$ (Note 4) | - | - | 1 | μA |
| I_{GSS} | Gate-to-Source Leakage Current | $V_{GS} = \pm 20\text{V}$ | - | - | ± 100 | nA |

On Characteristics

| | | | | | | |
|--------------|----------------------------------|---|-----|-----|-----|------------------|
| $V_{GS(th)}$ | Gate to Source Threshold Voltage | $V_{GS} = V_{DS}$, $I_D = 250\mu\text{A}$ | 2.0 | 3.0 | 4.0 | V |
| $R_{DS(on)}$ | Drain to Source On Resistance | $I_D = 80\text{A}$, $T_J = 25^\circ\text{C}$ $V_{GS} = 10\text{V}$, $T_J = 175^\circ\text{C}$ (Note 4) | - | 1.5 | 1.8 | $\text{m}\Omega$ |
| | | | - | 2.5 | 3.0 | $\text{m}\Omega$ |

Dynamic Characteristics

| | | | | | | |
|--------------|-------------------------------|---|---|------|----|----------|
| C_{iss} | Input Capacitance | $V_{DS} = 20\text{V}$, $V_{GS} = 0\text{V}$, $f = 1\text{MHz}$ | - | 5150 | - | pF |
| C_{oss} | Output Capacitance | | - | 1770 | - | pF |
| C_{rss} | Reverse Transfer Capacitance | | - | 89 | - | pF |
| R_g | Gate Resistance | $f = 1\text{MHz}$ | - | 2.8 | - | Ω |
| $Q_{g(ToT)}$ | Total Gate Charge | $V_{GS} = 0$ to 10V | - | 68 | 92 | nC |
| $Q_{g(th)}$ | Threshold Gate Charge | $V_{GS} = 0$ to 2V | | | | |
| Q_{gs} | Gate-to-Source Gate Charge | $V_{DD} = 32\text{V}$ $I_D = 80\text{A}$ | - | 22 | - | nC |
| Q_{gd} | Gate-to-Drain "Miller" Charge | | - | 12 | - | nC |

Switching Characteristics

| | | | | | | |
|--------------|----------------|---|---|----|----|----|
| t_{on} | Turn-On Time | $V_{DD} = 20\text{V}$, $I_D = 80\text{A}$, $V_{GS} = 10\text{V}$, $R_{GEN} = 6\Omega$ | - | - | 51 | ns |
| $t_{d(on)}$ | Turn-On Delay | | - | 19 | - | ns |
| t_r | Rise Time | | - | 20 | - | ns |
| $t_{d(off)}$ | Turn-Off Delay | | - | 41 | - | ns |
| t_f | Fall Time | | - | 19 | - | ns |
| t_{off} | Turn-Off Time | | - | - | 79 | ns |

Drain-Source Diode Characteristics

| | | | | | | |
|----------|-------------------------------|---|---|----|------|----|
| V_{SD} | Source-to-Drain Diode Voltage | $I_{SD} = 80\text{A}$, $V_{GS} = 0\text{V}$ | - | - | 1.25 | V |
| | | $I_{SD} = 40\text{A}$, $V_{GS} = 0\text{V}$ | - | - | 1.2 | V |
| t_{rr} | Reverse-Recovery Time | $I_F = 80\text{A}$, $dI_{SD}/dt = 100\text{A}/\mu\text{s}$ | - | 74 | 96 | ns |
| Q_{rr} | Reverse-Recovery Charge | $V_{DD} = 32\text{V}$ | - | 83 | 108 | nC |

Note:

4: The maximum value is specified by design at $T_J = 175^\circ\text{C}$. Product is not tested to this condition in production.

Typical Characteristics

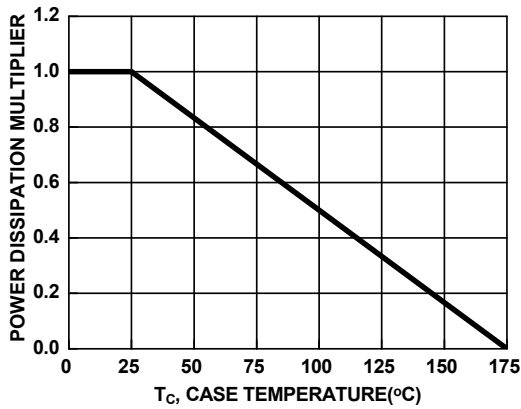

Figure 1. Normalized Power Dissipation vs. Case Temperature

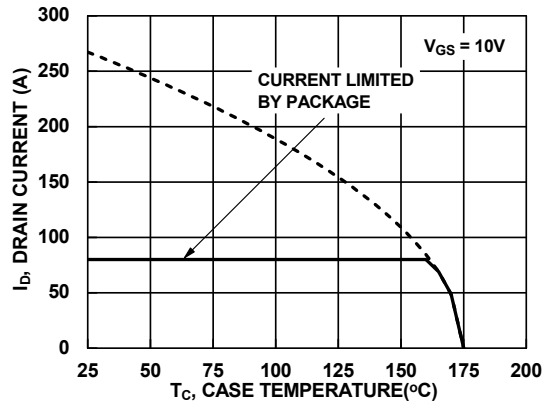

Figure 2. Maximum Continuous Drain Current vs. Case Temperature

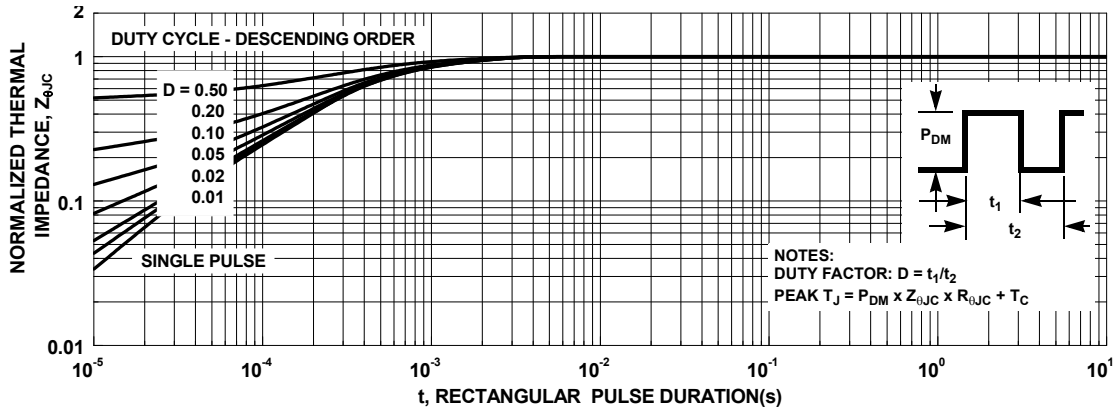

Figure 3. Normalized Maximum Transient Thermal Impedance

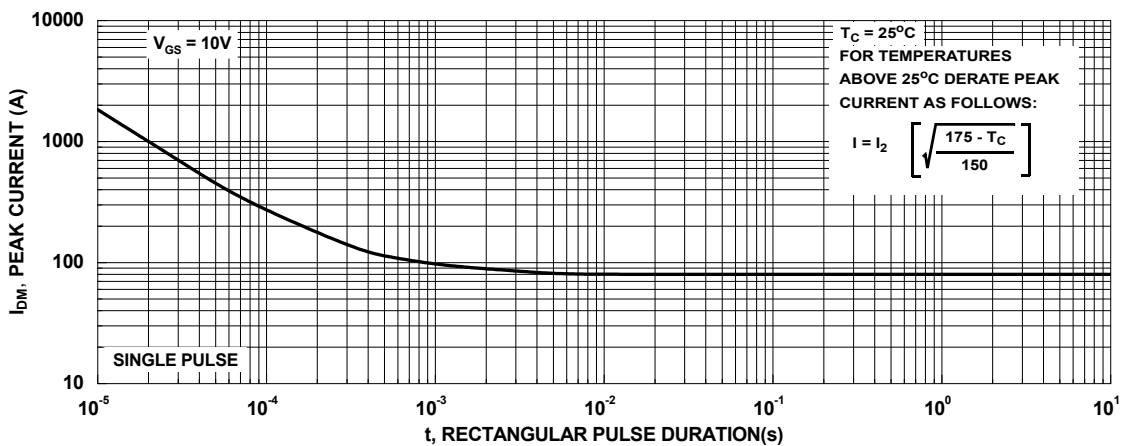

Figure 4. Peak Current Capability

Typical Characteristics

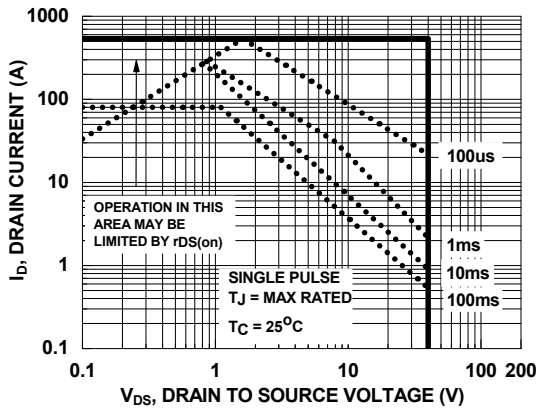
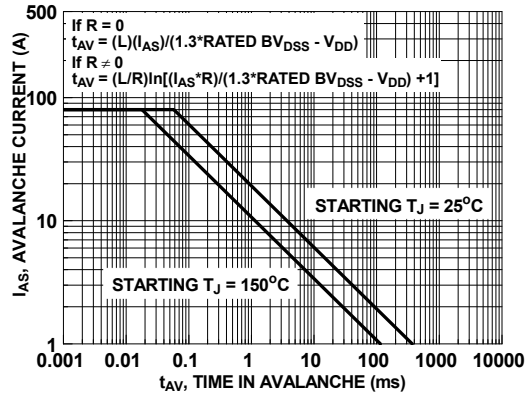

Figure 5. Forward Bias Safe Operating Area



NOTE: Refer to Fairchild Application Notes AN7514 and AN7515

Figure 6. Unclamped Inductive Switching Capability

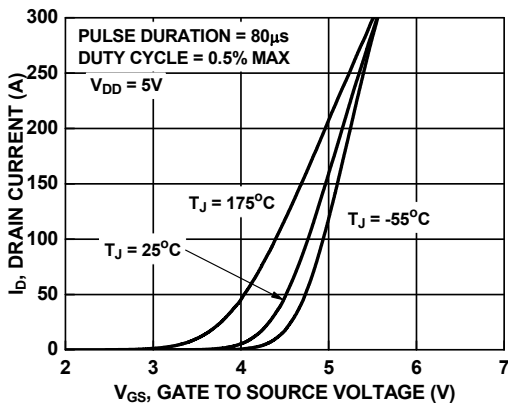

Figure 7. Transfer Characteristics

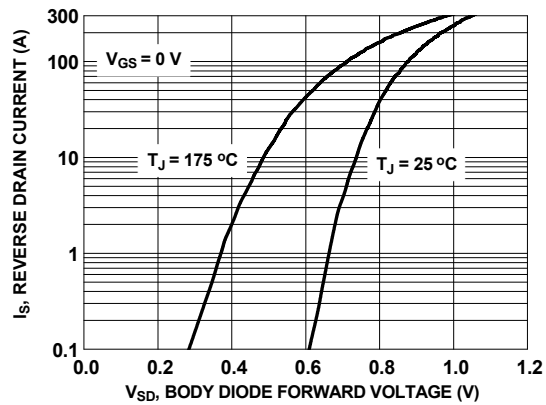

Figure 8. Forward Diode Characteristics

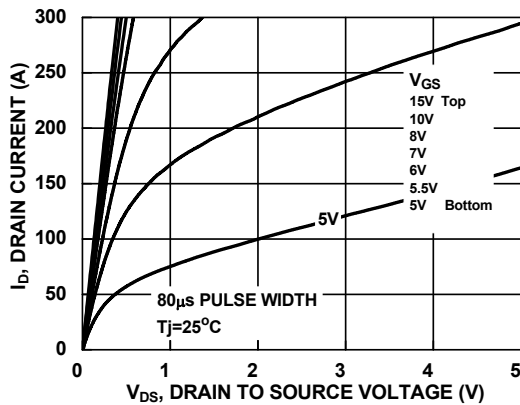

Figure 9. Saturation Characteristics

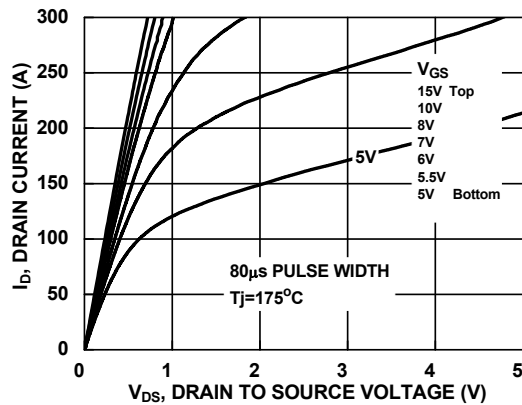

Figure 10. Saturation Characteristics

Typical Characteristics

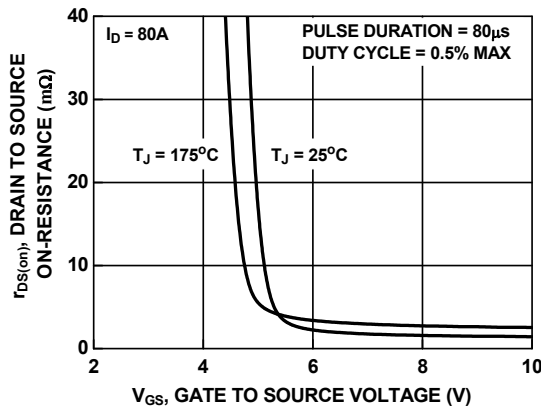

Figure 11. $R_{DS(on)}$ vs. Gate Voltage

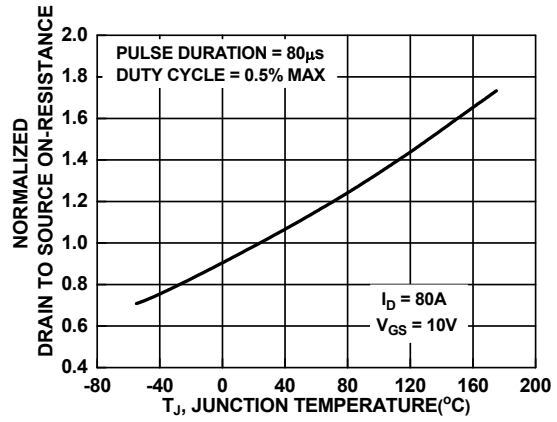

Figure 12. Normalized $R_{DS(on)}$ vs. Junction Temperature

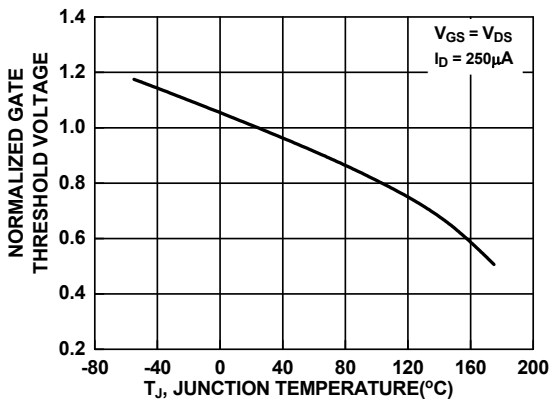

Figure 13. Normalized Gate Threshold Voltage vs. Temperature

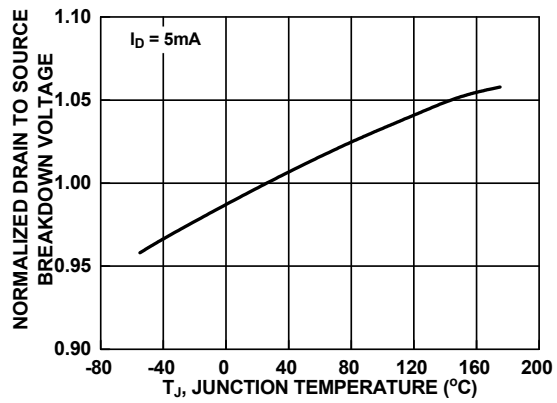

Figure 14. Normalized Drain to Source Breakdown Voltage vs. Junction Temperature

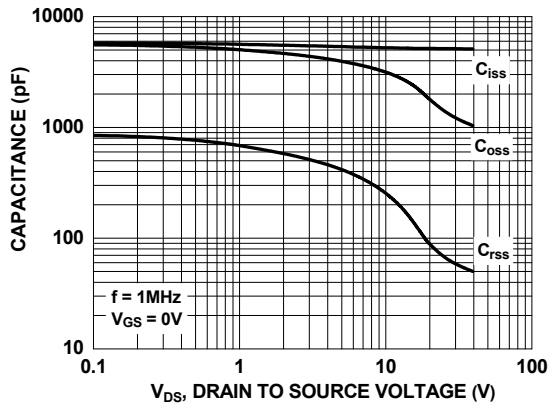

Figure 15. Capacitance vs. Drain to Source Voltage

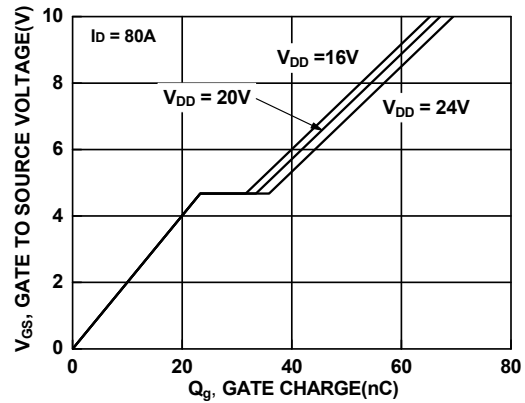
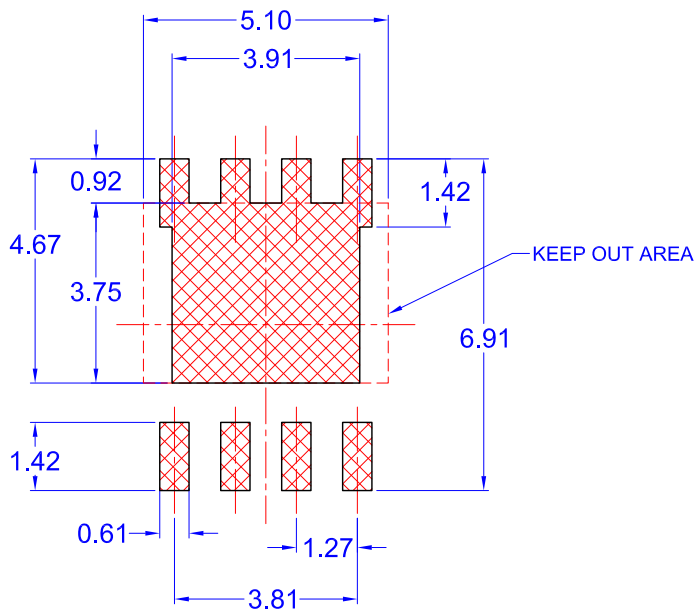
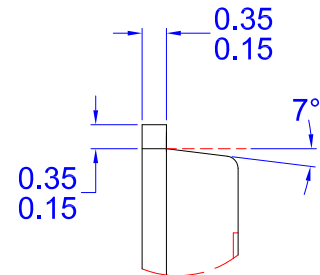
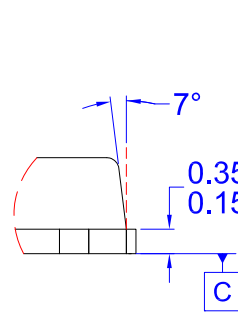
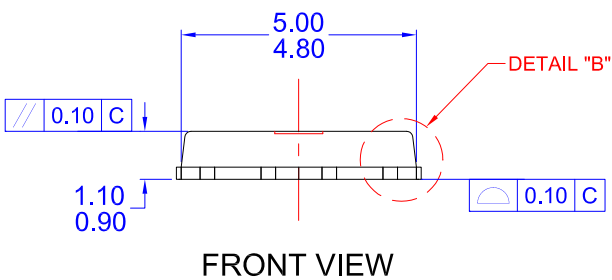
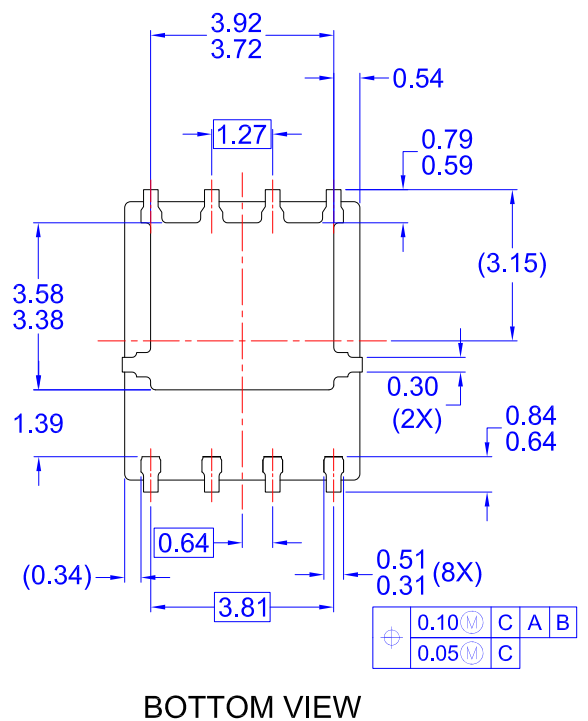
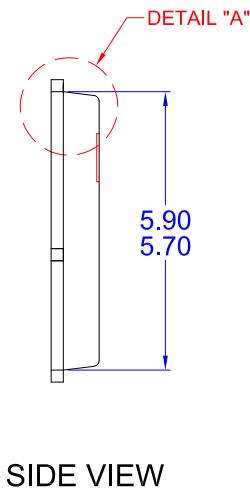
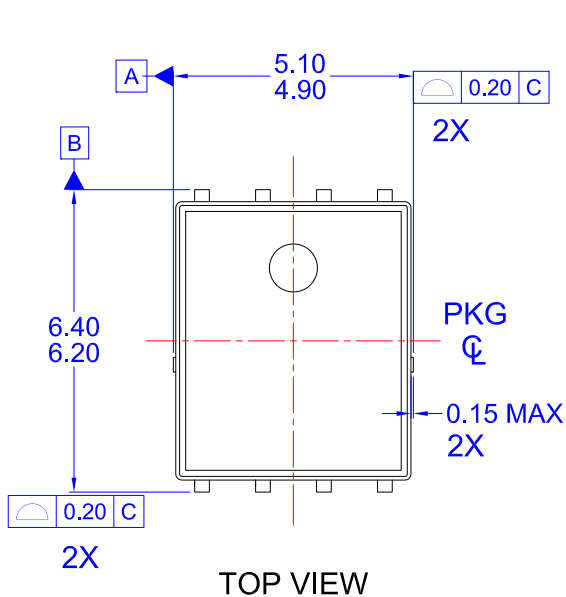

Figure 16. Gate Charge vs. Gate to Source Voltage



- NOTES: UNLESS OTHERWISE SPECIFIED
- A) PACKAGE STANDARD REFERENCE: JEDEC REGISTRATION, MO-240, ISSUE B DATED 10/2009
 - B) ALL DIMENSIONS ARE IN MILLIMETERS.
 - C) DIMENSIONS DO NOT INCLUDE BURRS OR MOLD FLASH. MOLD FLASH OR BURRS DOES NOT EXCEED 0.10MM.
 - D) DIMENSIONING AND TOLERANCING PER ASME Y14.5M-2009.
 - E) DRAWING FILE NAME: MKT-PQFN08MREV2





TRADEMARKS

The following includes registered and unregistered trademarks and service marks, owned by Fairchild Semiconductor and/or its global subsidiaries, and is not intended to be an exhaustive list of all such trademarks.

- | | | | |
|--------------------------|--|---------------------------------------|------------------|
| AccuPower™ | F-PFS™ | OPTOPLANAR® | SYSTEM GENERAL® |
| AttitudeEngine™ | FRFET® | Power Supply WebDesigner™ | TinyBoost® |
| Awinda® | Global Power Resource SM | PowerTrench® | TinyBuck® |
| AX-CAP®* | GreenBridge™ | PowerXS™ | TinyCalc™ |
| BitSiC™ | Green FPS™ | Programmable Active Droop™ | TinyLogic® |
| Build it Now™ | Green FPS™ e-Series™ | QFET® | TINYOPTO™ |
| CorePLUS™ | Gmax™ | QS™ | TinyPower™ |
| CorePOWER™ | GTO™ | Quiet Series™ | TinyPWM™ |
| CROSSVOL™ | IntelliMAX™ | RapidConfigure™ | TinyWire™ |
| CTL™ | ISOPLANAR™ | Saving our world, 1mW/W/kW at a time™ | TranSiC™ |
| Current Transfer Logic™ | Making Small Speakers Sound Louder and Better™ | SignalWise™ | TriFault Detect™ |
| DEUXPEED® | MegaBuck™ | SmartMax™ | TRUECURRENT®* |
| Dual Cool™ | MICROCOUPLER™ | SMART START™ | μSerDes™ |
| EcoSPARK® | MicroFET™ | Solutions for Your Success™ | UHC® |
| EfficientMax™ | MicroPak™ | SPM® | Ultra FRFET™ |
| ESBC™ | MicroPak2™ | STEALTH™ | UniFET™ |
| F [®] | MillerDrive™ | SuperFET® | VCX™ |
| Fairchild® | MotionMax™ | SuperSOT™-3 | VisualMax™ |
| Fairchild Semiconductor® | MotionGrid® | SuperSOT™-6 | VoltagePlus™ |
| FACT Quiet Series™ | MTi® | SuperSOT™-8 | XST™ |
| FACT® | MTx® | SupreMOS® | Xsens™ |
| FastvCore™ | MVN® | SyncFET™ | 仙童® |
| FETBench™ | mWSaver® | Sync-Lock™ | |
| FPS™ | OptoHiT™ | | |
| | OPTOLOGIC® | | |

* Trademarks of System General Corporation, used under license by Fairchild Semiconductor.

DISCLAIMER

FAIRCHILD SEMICONDUCTOR RESERVES THE RIGHT TO MAKE CHANGES WITHOUT FURTHER NOTICE TO ANY PRODUCTS HEREIN TO IMPROVE RELIABILITY, FUNCTION, OR DESIGN. TO OBTAIN THE LATEST, MOST UP-TO-DATE DATASHEET AND PRODUCT INFORMATION, VISIT OUR WEBSITE AT [HTTP://WWW.FAIRCHILDSEMI.COM](http://www.fairchildsemi.com). FAIRCHILD DOES NOT ASSUME ANY LIABILITY ARISING OUT OF THE APPLICATION OR USE OF ANY PRODUCT OR CIRCUIT DESCRIBED HEREIN; NEITHER DOES IT CONVEY ANY LICENSE UNDER ITS PATENT RIGHTS, NOR THE RIGHTS OF OTHERS. THESE SPECIFICATIONS DO NOT EXPAND THE TERMS OF FAIRCHILD'S WORLDWIDE TERMS AND CONDITIONS, SPECIFICALLY THE WARRANTY THEREIN, WHICH COVERS THESE PRODUCTS.

AUTHORIZED USE

Unless otherwise specified in this data sheet, this product is a standard commercial product and is not intended for use in applications that require extraordinary levels of quality and reliability. This product may not be used in the following applications, unless specifically approved in writing by a Fairchild officer: (1) automotive or other transportation, (2) military/aerospace, (3) any safety critical application – including life critical medical equipment – where the failure of the Fairchild product reasonably would be expected to result in personal injury, death or property damage. Customer's use of this product is subject to agreement of this Authorized Use policy. In the event of an unauthorized use of Fairchild's product, Fairchild accepts no liability in the event of product failure. In other respects, this product shall be subject to Fairchild's Worldwide Terms and Conditions of Sale, unless a separate agreement has been signed by both Parties.

ANTI-COUNTERFEITING POLICY

Fairchild Semiconductor Corporation's Anti-Counterfeiting Policy. Fairchild's Anti-Counterfeiting Policy is also stated on our external website, www.fairchildsemi.com, under Terms of Use

Counterfeiting of semiconductor parts is a growing problem in the industry. All manufacturers of semiconductor products are experiencing counterfeiting of their parts. Customers who inadvertently purchase counterfeit parts experience many problems such as loss of brand reputation, substandard performance, failed applications, and increased cost of production and manufacturing delays. Fairchild is taking strong measures to protect ourselves and our customers from the proliferation of counterfeit parts. Fairchild strongly encourages customers to purchase Fairchild parts either directly from Fairchild or from Authorized Fairchild Distributors who are listed by country on our web page cited above. Products customers buy either from Fairchild directly or from Authorized Fairchild Distributors are genuine parts, have full traceability, meet Fairchild's quality standards for handling and storage and provide access to Fairchild's full range of up-to-date technical and product information. Fairchild and our Authorized Distributors will stand behind all warranties and will appropriately address any warranty issues that may arise. Fairchild will not provide any warranty coverage or other assistance for parts bought from Unauthorized Sources. Fairchild is committed to combat this global problem and encourage our customers to do their part in stopping this practice by buying direct or from authorized distributors.

PRODUCT STATUS DEFINITIONS

Definition of Terms

| Datasheet Identification | Product Status | Definition |
|--------------------------|-----------------------|---|
| Advance Information | Formative / In Design | Datasheet contains the design specifications for product development. Specifications may change in any manner without notice. |
| Preliminary | First Production | Datasheet contains preliminary data; supplementary data will be published at a later date. Fairchild Semiconductor reserves the right to make changes at any time without notice to improve design. |
| No Identification Needed | Full Production | Datasheet contains final specifications. Fairchild Semiconductor reserves the right to make changes at any time without notice to improve the design. |
| Obsolete | Not In Production | Datasheet contains specifications on a product that is discontinued by Fairchild Semiconductor. The datasheet is for reference information only. |

Rev. I77

Mouser Electronics

Authorized Distributor

Click to View Pricing, Inventory, Delivery & Lifecycle Information:

[Fairchild Semiconductor:](#)

[FDMS9408_F085](#)