



Is Now Part of



ON Semiconductor®

To learn more about ON Semiconductor, please visit our website at

www.onsemi.com

ON Semiconductor and the ON Semiconductor logo are trademarks of Semiconductor Components Industries, LLC dba ON Semiconductor or its subsidiaries in the United States and/or other countries. ON Semiconductor owns the rights to a number of patents, trademarks, copyrights, trade secrets, and other intellectual property. A listing of ON Semiconductor's product/patent coverage may be accessed at www.onsemi.com/site/pdf/Patent-Marking.pdf. ON Semiconductor reserves the right to make changes without further notice to any products herein. ON Semiconductor makes no warranty, representation or guarantee regarding the suitability of its products for any particular purpose, nor does ON Semiconductor assume any liability arising out of the application or use of any product or circuit, and specifically disclaims any and all liability, including without limitation special, consequential or incidental damages. Buyer is responsible for its products and applications using ON Semiconductor products, including compliance with all laws, regulations and safety requirements or standards, regardless of any support or applications information provided by ON Semiconductor. "Typical" parameters which may be provided in ON Semiconductor data sheets and/or specifications can and do vary in different applications and actual performance may vary over time. All operating parameters, including "Typicals" must be validated for each customer application by customer's technical experts. ON Semiconductor does not convey any license under its patent rights nor the rights of others. ON Semiconductor products are not designed, intended, or authorized for use as a critical component in life support systems or any FDA Class 3 medical devices or medical devices with a same or similar classification in a foreign jurisdiction or any devices intended for implantation in the human body. Should Buyer purchase or use ON Semiconductor products for any such unintended or unauthorized application, Buyer shall indemnify and hold ON Semiconductor and its officers, employees, subsidiaries, affiliates, and distributors harmless against all claims, costs, damages, and expenses, and reasonable attorney fees arising out of, directly or indirectly, any claim of personal injury or death associated with such unintended or unauthorized use, even if such claim alleges that ON Semiconductor was negligent regarding the design or manufacture of the part. ON Semiconductor is an Equal Opportunity/Affirmative Action Employer. This literature is subject to all applicable copyright laws and is not for resale in any manner.



September 2014



LM78XX / LM78XXA 3-Terminal 1 A Positive Voltage Regulator

Features

- Output Current up to 1 A
- Output Voltages: 5, 6, 8, 9, 10, 12, 15, 18, 24 V
- Thermal Overload Protection
- Short-Circuit Protection
- Output Transistor Safe Operating Area Protection

Description

The LM78XX series of three-terminal positive regulators is available in the TO-220 package and with several fixed output voltages, making them useful in a wide range of applications. Each type employs internal current limiting, thermal shut-down, and safe operating area protection. If adequate heat sinking is provided, they can deliver over 1 A output current. Although designed primarily as fixed-voltage regulators, these devices can be used with external components for adjustable voltages and currents.



Ordering Information⁽¹⁾

Product Number	Output Voltage Tolerance	Package	Operating Temperature	Packing Method
LM7805CT	±4%	TO-220 (Single Gauge)	-40°C to +125°C	Rail
LM7806CT				
LM7808CT				
LM7809CT				
LM7810CT				
LM7812CT				
LM7815CT				
LM7818CT				
LM7824CT	±2%	TO-220 (Single Gauge)	0°C to +125°C	Rail
LM7805ACT				
LM7809ACT				
LM7810ACT				
LM7812ACT				
LM7815ACT				

Note:

1. Above output voltage tolerance is available at 25°C.

LM78XX / LM78XXA — 3-Terminal 1 A Positive Voltage Regulator

Block Diagram

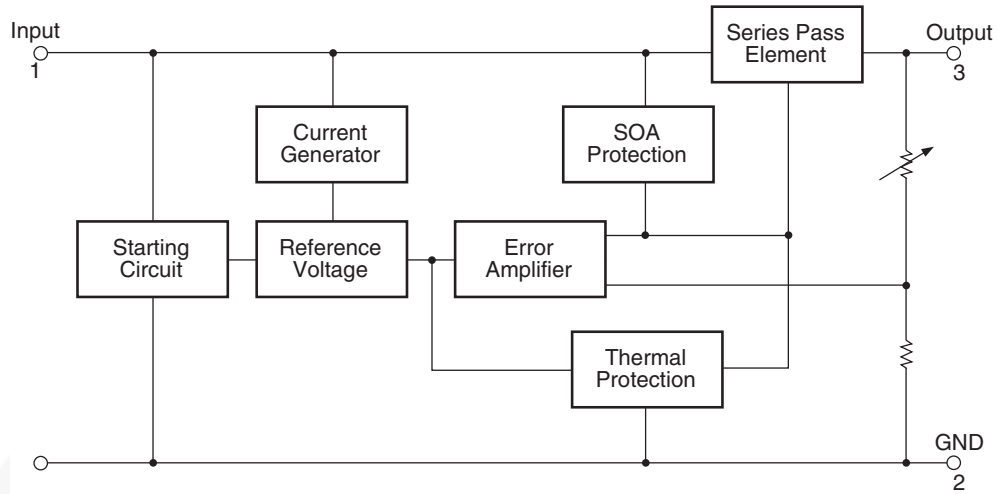

Figure 1. Block Diagram

Absolute Maximum Ratings

Stresses exceeding the absolute maximum ratings may damage the device. The device may not function or be operable above the recommended operating conditions and stressing the parts to these levels is not recommended. In addition, extended exposure to stresses above the recommended operating conditions may affect device reliability. The absolute maximum ratings are stress ratings only. Values are at $T_A = 25^\circ\text{C}$ unless otherwise noted.

Symbol	Parameter		Value	Unit
V_I	Input Voltage	$V_O = 5\text{ V to }18\text{ V}$	35	V
		$V_O = 24\text{ V}$	40	
$R_{\theta JC}$	Thermal Resistance, Junction-Case (TO-220)		5	$^\circ\text{C/W}$
$R_{\theta JA}$	Thermal Resistance, Junction-Air (TO-220)		65	$^\circ\text{C/W}$
T_{OPR}	Operating Temperature Range	LM78xx	-40 to +125	$^\circ\text{C}$
		LM78xxA	0 to +125	
T_{STG}	Storage Temperature Range		-65 to +150	$^\circ\text{C}$

Electrical Characteristics (LM7805)

Refer to the test circuit, $-40^{\circ}\text{C} < T_J < 125^{\circ}\text{C}$, $I_O = 500\text{ mA}$, $V_I = 10\text{ V}$, $C_I = 0.1\text{ }\mu\text{F}$, unless otherwise specified.

Symbol	Parameter	Conditions	Min.	Typ.	Max.	Unit	
V_O	Output Voltage	$T_J = +25^{\circ}\text{C}$	4.80	5.00	5.20	V	
		$I_O = 5\text{ mA to }1\text{ A}$, $P_O \leq 15\text{ W}$, $V_I = 7\text{ V to }20\text{ V}$	4.75	5.00	5.25		
Regline	Line Regulation ⁽²⁾	$T_J = +25^{\circ}\text{C}$	$V_I = 7\text{ V to }25\text{ V}$		4.0	100.0	mV
			$V_I = 8\text{ V to }12\text{ V}$		1.6	50.0	
Regload	Load Regulation ⁽²⁾	$T_J = +25^{\circ}\text{C}$	$I_O = 5\text{ mA to }1.5\text{ A}$		9.0	100.0	mV
			$I_O = 250\text{ mA to }750\text{ mA}$		4.0	50.0	
I_Q	Quiescent Current	$T_J = +25^{\circ}\text{C}$		5	8	mA	
ΔI_Q	Quiescent Current Change	$I_O = 5\text{ mA to }1\text{ A}$		0.03	0.50	mA	
		$V_I = 7\text{ V to }25\text{ V}$		0.30	1.30		
$\Delta V_O/\Delta T$	Output Voltage Drift ⁽³⁾	$I_O = 5\text{ mA}$		-0.8		mV/ $^{\circ}\text{C}$	
V_N	Output Noise Voltage	$f = 10\text{ Hz to }100\text{ kHz}$, $T_A = +25^{\circ}\text{C}$		42		μV	
RR	Ripple Rejection ⁽³⁾	$f = 120\text{ Hz}$, $V_I = 8\text{ V to }18\text{ V}$	62	73		dB	
V_{DROP}	Dropout Voltage	$T_J = +25^{\circ}\text{C}$, $I_O = 1\text{ A}$		2		V	
R_O	Output Resistance ⁽³⁾	$f = 1\text{ kHz}$		15		m Ω	
I_{SC}	Short-Circuit Current	$T_J = +25^{\circ}\text{C}$, $V_I = 35\text{ V}$		230		mA	
I_{PK}	Peak Current ⁽³⁾	$T_J = +25^{\circ}\text{C}$		2.2		A	

Notes:

- Load and line regulation are specified at constant junction temperature. Changes in V_O due to heating effects must be taken into account separately. Pulse testing with low duty is used.
- These parameters, although guaranteed, are not 100% tested in production.

Electrical Characteristics (LM7806)

Refer to the test circuit, $-40^{\circ}\text{C} < T_J < 125^{\circ}\text{C}$, $I_O = 500\text{ mA}$, $V_I = 11\text{ V}$, $C_I = 0.33\text{ }\mu\text{F}$, $C_O = 0.1\text{ }\mu\text{F}$, unless otherwise specified.

Symbol	Parameter	Conditions	Min.	Typ.	Max.	Unit	
V_O	Output Voltage	$T_J = +25^{\circ}\text{C}$	5.75	6.00	6.25	V	
		$I_O = 5\text{ mA to }1\text{ A}$, $P_O \leq 15\text{ W}$, $V_I = 8.0\text{ V to }21\text{ V}$	5.70	6.00	6.30		
Regline	Line Regulation ⁽⁴⁾	$T_J = +25^{\circ}\text{C}$	$V_I = 8\text{ V to }25\text{ V}$		5.0	120.0	mV
			$V_I = 9\text{ V to }13\text{ V}$		1.5	60.0	
Regload	Load Regulation ⁽⁴⁾	$T_J = +25^{\circ}\text{C}$	$I_O = 5\text{ mA to }1.5\text{ A}$		9.0	120.0	mV
			$I_O = 250\text{ mA to }750\text{ mA}$		3.0	60.0	
I_Q	Quiescent Current	$T_J = +25^{\circ}\text{C}$		5	8	mA	
ΔI_Q	Quiescent Current Change	$I_O = 5\text{ mA to }1\text{ A}$			0.5	mA	
		$V_I = 8\text{ V to }25\text{ V}$			1.3		
$\Delta V_O/\Delta T$	Output Voltage Drift ⁽⁵⁾	$I_O = 5\text{ mA}$		-0.8		mV/ $^{\circ}\text{C}$	
V_N	Output Noise Voltage	$f = 10\text{ Hz to }100\text{ kHz}$, $T_A = +25^{\circ}\text{C}$		45		μV	
RR	Ripple Rejection ⁽⁵⁾	$f = 120\text{ Hz}$, $V_I = 8\text{ V to }18\text{ V}$	62	73		dB	
V_{DROP}	Dropout Voltage	$T_J = +25^{\circ}\text{C}$, $I_O = 1\text{ A}$		2		V	
R_O	Output Resistance ⁽⁵⁾	$f = 1\text{ kHz}$		19		m Ω	
I_{SC}	Short-Circuit Current	$T_J = +25^{\circ}\text{C}$, $V_I = 35\text{ V}$		250		mA	
I_{PK}	Peak Current ⁽⁵⁾	$T_J = +25^{\circ}\text{C}$		2.2		A	

Notes:

- Load and line regulation are specified at constant junction temperature. Changes in V_O due to heating effects must be taken into account separately. Pulse testing with low duty is used.
- These parameters, although guaranteed, are not 100% tested in production.

Electrical Characteristics (LM7808)

Refer to the test circuit, $-40^{\circ}\text{C} < T_J < 125^{\circ}\text{C}$, $I_O = 500\text{ mA}$, $V_I = 14\text{ V}$, $C_I = 0.33\text{ }\mu\text{F}$, $C_O = 0.1\text{ }\mu\text{F}$, unless otherwise specified.

Symbol	Parameter	Conditions	Min.	Typ.	Max.	Unit	
V_O	Output Voltage	$T_J = +25^{\circ}\text{C}$	7.7	8.0	8.3	V	
		$I_O = 5\text{ mA to }1\text{ A}$, $P_O \leq 15\text{ W}$, $V_I = 10.5\text{ V to }23\text{ V}$	7.6	8.0	8.4		
Regline	Line Regulation ⁽⁶⁾	$T_J = +25^{\circ}\text{C}$	$V_I = 10.5\text{ V to }25\text{ V}$		5	160	mV
			$V_I = 11.5\text{ V to }17\text{ V}$		2	80	
Regload	Load Regulation ⁽⁶⁾	$T_J = +25^{\circ}\text{C}$	$I_O = 5\text{ mA to }1.5\text{ A}$		10	160	mV
			$I_O = 250\text{ mA to }750\text{ mA}$		5	80	
I_Q	Quiescent Current	$T_J = +25^{\circ}\text{C}$		5	8	mA	
ΔI_Q	Quiescent Current Change	$I_O = 5\text{ mA to }1\text{ A}$ $V_I = 10.5\text{ V to }25\text{ V}$		0.05	0.50	mA	
				0.5	1.0		
$\Delta V_O/\Delta T$	Output Voltage Drift ⁽⁷⁾	$I_O = 5\text{ mA}$		-0.8		mV/ $^{\circ}\text{C}$	
V_N	Output Noise Voltage	$f = 10\text{ Hz to }100\text{ kHz}$, $T_A = +25^{\circ}\text{C}$		52		μV	
RR	Ripple Rejection ⁽⁷⁾	$f = 120\text{ Hz}$, $V_I = 11.5\text{ V to }21.5\text{ V}$	56	73		dB	
V_{DROP}	Dropout Voltage	$I_O = 1\text{ A}$, $T_J = +25^{\circ}\text{C}$		2		V	
R_O	Output Resistance ⁽⁷⁾	$f = 1\text{ kHz}$		17		m Ω	
I_{SC}	Short-Circuit Current	$V_I = 35\text{ V}$, $T_J = +25^{\circ}\text{C}$		230		mA	
I_{PK}	Peak Current ⁽⁷⁾	$T_J = +25^{\circ}\text{C}$		2.2		A	

Notes:

- Load and line regulation are specified at constant junction temperature. Changes in V_O due to heating effects must be taken into account separately. Pulse testing with low duty is used.
- These parameters, although guaranteed, are not 100% tested in production.

Electrical Characteristics (LM7809)

Refer to the test circuit, $-40^{\circ}\text{C} < T_J < 125^{\circ}\text{C}$, $I_O = 500\text{ mA}$, $V_I = 15\text{ V}$, $C_I = 0.33\text{ }\mu\text{F}$, $C_O = 0.1\text{ }\mu\text{F}$, unless otherwise specified.

Symbol	Parameter	Conditions	Min.	Typ.	Max.	Unit	
V_O	Output Voltage	$T_J = +25^{\circ}\text{C}$	8.65	9.00	9.35	V	
		$I_O = 5\text{ mA to }1\text{ A}$, $P_O \leq 15\text{ W}$, $V_I = 11.5\text{ V to }24\text{ V}$	8.60	9.00	9.40		
Regline	Line Regulation ⁽⁸⁾	$T_J = +25^{\circ}\text{C}$	$V_I = 11.5\text{ V to }25\text{ V}$		6	180	mV
			$V_I = 12\text{ V to }17\text{ V}$		2	90	
Regload	Load Regulation ⁽⁸⁾	$T_J = +25^{\circ}\text{C}$	$I_O = 5\text{ mA to }1.5\text{ A}$		12	180	mV
			$I_O = 250\text{ mA to }750\text{ mA}$		4	90	
I_Q	Quiescent Current	$T_J = +25^{\circ}\text{C}$		5	8	mA	
ΔI_Q	Quiescent Current Change	$I_O = 5\text{ mA to }1\text{ A}$			0.5	mA	
		$V_I = 11.5\text{ V to }26\text{ V}$			1.3		
$\Delta V_O/\Delta T$	Output Voltage Drift ⁽⁹⁾	$I_O = 5\text{ mA}$		-1		mV/ $^{\circ}\text{C}$	
V_N	Output Noise Voltage	$f = 10\text{ Hz to }100\text{ kHz}$, $T_A = +25^{\circ}\text{C}$		58		μV	
RR	Ripple Rejection ⁽⁹⁾	$f = 120\text{ Hz}$, $V_I = 13\text{ V to }23\text{ V}$	56	71		dB	
V_{DROP}	Dropout Voltage	$I_O = 1\text{ A}$, $T_J = +25^{\circ}\text{C}$		2		V	
R_O	Output Resistance ⁽⁹⁾	$f = 1\text{ kHz}$		17		m Ω	
I_{SC}	Short-Circuit Current	$V_I = 35\text{ V}$, $T_J = +25^{\circ}\text{C}$		250		mA	
I_{PK}	Peak Current ⁽⁹⁾	$T_J = +25^{\circ}\text{C}$		2.2		A	

Notes:

8. Load and line regulation are specified at constant junction temperature. Changes in V_O due to heating effects must be taken into account separately. Pulse testing with low duty is used.
9. These parameters, although guaranteed, are not 100% tested in production.

Electrical Characteristics (LM7810)

Refer to the test circuit, $-40^{\circ}\text{C} < T_J < 125^{\circ}\text{C}$, $I_O = 500\text{ mA}$, $V_I = 16\text{ V}$, $C_I = 0.33\text{ }\mu\text{F}$, $C_O = 0.1\text{ }\mu\text{F}$, unless otherwise specified.

Symbol	Parameter	Conditions	Min.	Typ.	Max.	Unit	
V_O	Output Voltage	$T_J = +25^{\circ}\text{C}$	9.6	10.0	10.4	V	
		$I_O = 5\text{ mA to }1\text{ A}$, $P_O \leq 15\text{ W}$, $V_I = 12.5\text{ V to }25\text{ V}$	9.5	10.0	10.5		
Regline	Line Regulation ⁽¹⁰⁾	$T_J = +25^{\circ}\text{C}$	$V_I = 12.5\text{ V to }25\text{ V}$		10	200	mV
			$V_I = 13\text{ V to }25\text{ V}$		3	100	
Regload	Load Regulation ⁽¹⁰⁾	$T_J = +25^{\circ}\text{C}$	$I_O = 5\text{ mA to }1.5\text{ A}$		12	200	mV
			$I_O = 250\text{ mA to }750\text{ mA}$		4	400	
I_Q	Quiescent Current	$T_J = +25^{\circ}\text{C}$		5.1	8.0	mA	
ΔI_Q	Quiescent Current Change	$I_O = 5\text{ mA to }1\text{ A}$			0.5	mA	
		$V_I = 12.5\text{ V to }29\text{ V}$			1.0		
$\Delta V_O/\Delta T$	Output Voltage Drift ⁽¹¹⁾	$I_O = 5\text{ mA}$		-1		mV/ $^{\circ}\text{C}$	
V_N	Output Noise Voltage	$f = 10\text{ Hz to }100\text{ kHz}$, $T_A = +25^{\circ}\text{C}$		58		μV	
RR	Ripple Rejection ⁽¹¹⁾	$f = 120\text{ Hz}$, $V_I = 13\text{ V to }23\text{ V}$	56	71		dB	
V_{DROP}	Dropout Voltage	$I_O = 1\text{ A}$, $T_J = +25^{\circ}\text{C}$		2		V	
R_O	Output Resistance ⁽¹¹⁾	$f = 1\text{ kHz}$		17		m Ω	
I_{SC}	Short-Circuit Current	$V_I = 35\text{ V}$, $T_J = +25^{\circ}\text{C}$		250		mA	
I_{PK}	Peak Current ⁽¹¹⁾	$T_J = +25^{\circ}\text{C}$		2.2		A	

Notes:

10. Load and line regulation are specified at constant junction temperature. Changes in V_O due to heating effects must be taken into account separately. Pulse testing with low duty is used.
11. These parameters, although guaranteed, are not 100% tested in production.

Electrical Characteristics (LM7812)

Refer to the test circuit, $-40^{\circ}\text{C} < T_J < 125^{\circ}\text{C}$, $I_O = 500\text{ mA}$, $V_I = 19\text{ V}$, $C_I = 0.33\text{ }\mu\text{F}$, $C_O = 0.1\text{ }\mu\text{F}$, unless otherwise specified.

Symbol	Parameter	Conditions	Min.	Typ.	Max.	Unit	
V_O	Output Voltage	$T_J = +25^{\circ}\text{C}$	11.5	12.0	12.5	V	
		$I_O = 5\text{ mA to }1\text{ A}$, $P_O \leq 15\text{ W}$, $V_I = 14.5\text{ V to }27\text{ V}$	11.4	12.0	12.6		
Regline	Line Regulation ⁽¹²⁾	$T_J = +25^{\circ}\text{C}$	$V_I = 14.5\text{ V to }30\text{ V}$		10	240	mV
			$V_I = 16\text{ V to }22\text{ V}$		3	120	
Regload	Load Regulation ⁽¹²⁾	$T_J = +25^{\circ}\text{C}$	$I_O = 5\text{ mA to }1.5\text{ A}$		11	240	mV
			$I_O = 250\text{ mA to }750\text{ mA}$		5	120	
I_Q	Quiescent Current	$T_J = +25^{\circ}\text{C}$		5.1	8.0	mA	
ΔI_Q	Quiescent Current Change	$I_O = 5\text{ mA to }1\text{ A}$ $V_I = 14.5\text{ V to }30\text{ V}$		0.1	0.5	mA	
				0.5	1.0		
$\Delta V_O/\Delta T$	Output Voltage Drift ⁽¹³⁾	$I_O = 5\text{ mA}$		-1		mV/ $^{\circ}\text{C}$	
V_N	Output Noise Voltage	$f = 10\text{ Hz to }100\text{ kHz}$, $T_A = +25^{\circ}\text{C}$		76		μV	
RR	Ripple Rejection ⁽¹³⁾	$f = 120\text{ Hz}$, $V_I = 15\text{ V to }25\text{ V}$	55	71		dB	
V_{DROP}	Dropout Voltage	$I_O = 1\text{ A}$, $T_J = +25^{\circ}\text{C}$		2		V	
R_O	Output Resistance ⁽¹³⁾	$f = 1\text{ kHz}$		18		m Ω	
I_{SC}	Short-Circuit Current	$V_I = 35\text{ V}$, $T_J = +25^{\circ}\text{C}$		230		mA	
I_{PK}	Peak Current ⁽¹³⁾	$T_J = +25^{\circ}\text{C}$		2.2		A	

Notes:

12. Load and line regulation are specified at constant junction temperature. Changes in V_O due to heating effects must be taken into account separately. Pulse testing with low duty is used.
13. These parameters, although guaranteed, are not 100% tested in production.

Electrical Characteristics (LM7815)

Refer to the test circuit, $-40^{\circ}\text{C} < T_J < 125^{\circ}\text{C}$, $I_O = 500\text{ mA}$, $V_I = 23\text{ V}$, $C_I = 0.33\text{ }\mu\text{F}$, $C_O = 0.1\text{ }\mu\text{F}$, unless otherwise specified.

Symbol	Parameter	Conditions	Min.	Typ.	Max.	Unit	
V_O	Output Voltage	$T_J = +25^{\circ}\text{C}$	14.40	15.00	15.60	V	
		$I_O = 5\text{ mA to }1\text{ A}$, $P_O \leq 15\text{ W}$, $V_I = 17.5\text{ V to }30\text{ V}$	14.25	15.00	15.75		
Regline	Line Regulation ⁽¹⁴⁾	$T_J = +25^{\circ}\text{C}$	$V_I = 17.5\text{ V to }30\text{ V}$		11	300	mV
			$V_I = 20\text{ V to }26\text{ V}$		3	150	
Regload	Load Regulation ⁽¹⁴⁾	$T_J = +25^{\circ}\text{C}$	$I_O = 5\text{ mA to }1.5\text{ A}$		12	300	mV
			$I_O = 250\text{ mA to }750\text{ mA}$		4	150	
I_Q	Quiescent Current	$T_J = +25^{\circ}\text{C}$		5.2	8.0	mA	
ΔI_Q	Quiescent Current Change	$I_O = 5\text{ mA to }1\text{ A}$			0.5	mA	
		$V_I = 17.5\text{ V to }30\text{ V}$			1.0		
$\Delta V_O/\Delta T$	Output Voltage Drift ⁽¹⁵⁾	$I_O = 5\text{ mA}$		-1		mV/ $^{\circ}\text{C}$	
V_N	Output Noise Voltage	$f = 10\text{ Hz to }100\text{ kHz}$, $T_A = +25^{\circ}\text{C}$		90		μV	
RR	Ripple Rejection ⁽¹⁵⁾	$f = 120\text{ Hz}$, $V_I = 18.5\text{ V to }28.5\text{ V}$	54	70		dB	
V_{DROP}	Dropout Voltage	$I_O = 1\text{ A}$, $T_J = +25^{\circ}\text{C}$		2		V	
R_O	Output Resistance ⁽¹⁵⁾	$f = 1\text{ kHz}$		19		m Ω	
I_{SC}	Short-Circuit Current	$V_I = 35\text{ V}$, $T_J = +25^{\circ}\text{C}$		250		mA	
I_{PK}	Peak Current ⁽¹⁵⁾	$T_J = +25^{\circ}\text{C}$		2.2		A	

Notes:

14. Load and line regulation are specified at constant junction temperature. Changes in V_O due to heating effects must be taken into account separately. Pulse testing with low duty is used.
15. These parameters, although guaranteed, are not 100% tested in production.

Electrical Characteristics (LM7818)

Refer to the test circuit, $-40^{\circ}\text{C} < T_J < 125^{\circ}\text{C}$, $I_O = 500\text{ mA}$, $V_I = 27\text{ V}$, $C_I = 0.33\text{ }\mu\text{F}$, $C_O = 0.1\text{ }\mu\text{F}$, unless otherwise specified.

Symbol	Parameter	Conditions	Min.	Typ.	Max.	Unit	
V_O	Output Voltage	$T_J = +25^{\circ}\text{C}$	17.3	18.0	18.7	V	
		$I_O = 5\text{ mA to }1\text{ A}$, $P_O \leq 15\text{ W}$, $V_I = 21\text{ V to }33\text{ V}$	17.1	18.0	18.9		
Regline	Line Regulation ⁽¹⁶⁾	$T_J = +25^{\circ}\text{C}$	$V_I = 21\text{ V to }33\text{ V}$		15	360	mV
			$V_I = 24\text{ V to }30\text{ V}$		5	180	
Regload	Load Regulation ⁽¹⁶⁾	$T_J = +25^{\circ}\text{C}$	$I_O = 5\text{ mA to }1.5\text{ A}$		15	360	mV
			$I_O = 250\text{ mA to }750\text{ mA}$		5	180	
I_Q	Quiescent Current	$T_J = +25^{\circ}\text{C}$		5.2	8.0	mA	
ΔI_Q	Quiescent Current Change	$I_O = 5\text{ mA to }1\text{ A}$			0.5	mA	
		$V_I = 21\text{ V to }33\text{ V}$			1.0		
$\Delta V_O/\Delta T$	Output Voltage Drift ⁽¹⁷⁾	$I_O = 5\text{ mA}$		-1		mV/ $^{\circ}\text{C}$	
V_N	Output Noise Voltage	$f = 10\text{ Hz to }100\text{ kHz}$, $T_A = +25^{\circ}\text{C}$		110		μV	
RR	Ripple Rejection ⁽¹⁷⁾	$f = 120\text{ Hz}$, $V_I = 22\text{ V to }32\text{ V}$	53	69		dB	
V_{DROP}	Dropout Voltage	$I_O = 1\text{ A}$, $T_J = +25^{\circ}\text{C}$		2		V	
R_O	Output Resistance ⁽¹⁷⁾	$f = 1\text{ kHz}$		22		m Ω	
I_{SC}	Short-Circuit Current	$V_I = 35\text{ V}$, $T_J = +25^{\circ}\text{C}$		250		mA	
I_{PK}	Peak Current ⁽¹⁷⁾	$T_J = +25^{\circ}\text{C}$		2.2		A	

Notes:

16. Load and line regulation are specified at constant junction temperature. Changes in V_O due to heating effects must be taken into account separately. Pulse testing with low duty is used.
17. These parameters, although guaranteed, are not 100% tested in production.

Electrical Characteristics (LM7824)

Refer to the test circuit, $-40^{\circ}\text{C} < T_J < 125^{\circ}\text{C}$, $I_O = 500\text{ mA}$, $V_I = 33\text{ V}$, $C_I = 0.33\text{ }\mu\text{F}$, $C_O = 0.1\text{ }\mu\text{F}$, unless otherwise specified.

Symbol	Parameter	Conditions	Min.	Typ.	Max.	Unit	
V_O	Output Voltage	$T_J = +25^{\circ}\text{C}$	23.00	24.00	25.00	V	
		$I_O = 5\text{ mA to }1\text{ A}$, $P_O \leq 15\text{ W}$, $V_I = 27\text{ V to }38\text{ V}$	22.80	24.00	25.25		
Regline	Line Regulation ⁽¹⁸⁾	$T_J = +25^{\circ}\text{C}$	$V_I = 27\text{ V to }38\text{ V}$		17	480	mV
			$V_I = 30\text{ V to }36\text{ V}$		6	240	
Regload	Load Regulation ⁽¹⁸⁾	$T_J = +25^{\circ}\text{C}$	$I_O = 5\text{ mA to }1.5\text{ A}$		15	480	mV
			$I_O = 250\text{ mA to }750\text{ mA}$		5	240	
I_Q	Quiescent Current	$T_J = +25^{\circ}\text{C}$		5.2	8.0	mA	
ΔI_Q	Quiescent Current Change	$I_O = 5\text{ mA to }1\text{ A}$ $V_I = 27\text{ V to }38\text{ V}$		0.1	0.5	mA	
				0.5	1.0		
$\Delta V_O/\Delta T$	Output Voltage Drift ⁽¹⁹⁾	$I_O = 5\text{ mA}$		-1.5		mV/ $^{\circ}\text{C}$	
V_N	Output Noise Voltage	$f = 10\text{ Hz to }100\text{ kHz}$, $T_A = +25^{\circ}\text{C}$		120		μV	
RR	Ripple Rejection ⁽¹⁹⁾	$f = 120\text{ Hz}$, $V_I = 28\text{ V to }38\text{ V}$	50	67		dB	
V_{DROPP}	Dropout Voltage	$I_O = 1\text{ A}$, $T_J = +25^{\circ}\text{C}$		2		V	
R_O	Output Resistance ⁽¹⁹⁾	$f = 1\text{ kHz}$		28		m Ω	
I_{SC}	Short-Circuit Current	$V_I = 35\text{ V}$, $T_J = +25^{\circ}\text{C}$		230		mA	
I_{PK}	Peak Current ⁽¹⁹⁾	$T_J = +25^{\circ}\text{C}$		2.2		A	

Notes:

18. Load and line regulation are specified at constant junction temperature. Changes in V_O due to heating effects must be taken into account separately. Pulse testing with low duty is used.
19. These parameters, although guaranteed, are not 100% tested in production.

Electrical Characteristics (LM7805A)Refer to the test circuit, $0^{\circ}\text{C} < T_J < 125^{\circ}\text{C}$, $I_O = 1\text{ A}$, $V_I = 10\text{ V}$, $C_I = 0.33\text{ }\mu\text{F}$, $C_O = 0.1\text{ }\mu\text{F}$, unless otherwise specified.

Symbol	Parameter	Conditions	Min.	Typ.	Max.	Unit	
V_O	Output Voltage	$T_J = +25^{\circ}\text{C}$	4.9	5.0	5.1	V	
		$I_O = 5\text{ mA to }1\text{ A}$, $P_O \leq 15\text{ W}$, $V_I = 7.5\text{ V to }20\text{ V}$	4.8	5.0	5.2		
Regline	Line Regulation ⁽²⁰⁾	$V_I = 7.5\text{ V to }25\text{ V}$, $I_O = 500\text{ mA}$		5.0	50.0	mV	
		$V_I = 8\text{ V to }12\text{ V}$		3.0	50.0		
		$T_J = +25^{\circ}\text{C}$	$V_I = 7.3\text{ V to }20\text{ V}$		5.0		50.0
			$V_I = 8\text{ V to }12\text{ V}$		1.5		25.0
Regload	Load Regulation ⁽²⁰⁾	$T_J = +25^{\circ}\text{C}$, $I_O = 5\text{ mA to }1.5\text{ A}$		9	100	mV	
		$I_O = 5\text{ mA to }1\text{ A}$		9	100		
		$I_O = 250\text{ mA to }750\text{ mA}$		4	50		
I_Q	Quiescent Current	$T_J = +25^{\circ}\text{C}$		5	6	mA	
ΔI_Q	Quiescent Current Change	$I_O = 5\text{ mA to }1\text{ A}$			0.5	mA	
		$V_I = 8\text{ V to }25\text{ V}$, $I_O = 500\text{ mA}$			0.8		
		$V_I = 7.5\text{ V to }20\text{ V}$, $T_J = +25^{\circ}\text{C}$			0.8		
$\Delta V_O/\Delta T$	Output Voltage Drift ⁽²¹⁾	$I_O = 5\text{ mA}$		-0.8		mV/ $^{\circ}\text{C}$	
V_N	Output Noise Voltage	$f = 10\text{ Hz to }100\text{ kHz}$, $T_A = +25^{\circ}\text{C}$		42		μV	
RR	Ripple Rejection ⁽²¹⁾	$f = 120\text{ Hz}$, $V_O = 500\text{ mA}$, $V_I = 8\text{ V to }18\text{ V}$		68		dB	
V_{DROP}	Dropout Voltage	$I_O = 1\text{ A}$, $T_J = +25^{\circ}\text{C}$		2		V	
R_O	Output Resistance ⁽²¹⁾	$f = 1\text{ kHz}$		17		m Ω	
I_{SC}	Short-Circuit Current	$V_I = 35\text{ V}$, $T_J = +25^{\circ}\text{C}$		250		mA	
I_{PK}	Peak Current ⁽²¹⁾	$T_J = +25^{\circ}\text{C}$		2.2		A	

Notes:

20. Load and line regulation are specified at constant junction temperature. Changes in V_O due to heating effects must be taken into account separately. Pulse testing with low duty is used.

21. These parameters, although guaranteed, are not 100% tested in production.

Electrical Characteristics (LM7809A)Refer to the test circuit, $0^{\circ}\text{C} < T_J < 125^{\circ}\text{C}$, $I_O = 1\text{ A}$, $V_I = 15\text{ V}$, $C_I = 0.33\text{ }\mu\text{F}$, $C_O = 0.1\text{ }\mu\text{F}$, unless otherwise specified.

Symbol	Parameter	Conditions	Min.	Typ.	Max.	Unit	
V_O	Output Voltage	$T_J = +25^{\circ}\text{C}$	8.82	9.00	9.16	V	
		$I_O = 5\text{ mA to }1\text{ A}$, $P_O \leq 15\text{ W}$, $V_I = 11.2\text{ V to }24\text{ V}$	8.65	9.00	9.35		
Regline	Line Regulation ⁽²²⁾	$V_I = 11.7\text{ V to }25\text{ V}$, $I_O = 500\text{ mA}$		6	90	mV	
		$V_I = 12.5\text{ V to }19\text{ V}$		4	45		
		$T_J = +25^{\circ}\text{C}$	$V_I = 11.5\text{ V to }24\text{ V}$		6		90
			$V_I = 12.5\text{ V to }19\text{ V}$		2		45
Regload	Load Regulation ⁽²²⁾	$T_J = +25^{\circ}\text{C}$, $I_O = 5\text{ mA to }1.5\text{ A}$		12	100	mV	
		$I_O = 5\text{ mA to }1\text{ A}$		12	100		
		$I_O = 250\text{ mA to }750\text{ mA}$		5	50		
I_Q	Quiescent Current	$T_J = +25^{\circ}\text{C}$		5	6	mA	
ΔI_Q	Quiescent Current Change	$I_O = 5\text{ mA to }1\text{ A}$			0.5	mA	
		$V_I = 12\text{ V to }25\text{ V}$, $I_O = 500\text{ mA}$			0.8		
		$V_I = 11.7\text{ V to }25\text{ V}$, $T_J = +25^{\circ}\text{C}$			0.8		
$\Delta V_O/\Delta T$	Output Voltage Drift ⁽²³⁾	$I_O = 5\text{ mA}$		-1		mV/ $^{\circ}\text{C}$	
V_N	Output Noise Voltage	$f = 10\text{ Hz to }100\text{ kHz}$, $T_A = +25^{\circ}\text{C}$		58		μV	
RR	Ripple Rejection ⁽²³⁾	$f = 120\text{ Hz}$, $V_O = 500\text{ mA}$, $V_I = 12\text{ V to }22\text{ V}$		62		dB	
V_{DROP}	Dropout Voltage	$I_O = 1\text{ A}$, $T_J = +25^{\circ}\text{C}$		2		V	
R_O	Output Resistance ⁽²³⁾	$f = 1\text{ kHz}$		17		m Ω	
I_{SC}	Short-Circuit Current	$V_I = 35\text{ V}$, $T_J = +25^{\circ}\text{C}$		250		mA	
I_{PK}	Peak Current ⁽²³⁾	$T_J = +25^{\circ}\text{C}$		2.2		A	

Notes:

22. Load and line regulation are specified at constant junction temperature. Changes in V_O due to heating effects must be taken into account separately. Pulse testing with low duty is used.

23. These parameters, although guaranteed, are not 100% tested in production.

Electrical Characteristics (LM7810A)

Refer to the test circuit, $0^{\circ}\text{C} < T_J < 125^{\circ}\text{C}$, $I_O = 1\text{ A}$, $V_I = 16\text{ V}$, $C_I = 0.33\text{ }\mu\text{F}$, $C_O = 0.1\text{ }\mu\text{F}$, unless otherwise specified.

Symbol	Parameter	Conditions	Min.	Typ.	Max.	Unit	
V_O	Output Voltage	$T_J = +25^{\circ}\text{C}$	9.8	10.0	10.2	V	
		$I_O = 5\text{ mA to }1\text{ A}$, $P_O \leq 15\text{ W}$, $V_I = 12.8\text{ V to }25\text{ V}$	9.6	10.0	10.4		
Regline	Line Regulation ⁽²⁴⁾	$V_I = 12.8\text{ V to }26\text{ V}$, $I_O = 500\text{ mA}$		8	100	mV	
		$V_I = 13\text{ V to }20\text{ V}$		4	50		
		$T_J = +25^{\circ}\text{C}$	$V_I = 12.5\text{ V to }25\text{ V}$		8		100
			$V_I = 13\text{ V to }20\text{ V}$		3		50
Regload	Load Regulation ⁽²⁴⁾	$T_J = +25^{\circ}\text{C}$, $I_O = 5\text{ mA to }1.5\text{ A}$		12	100	mV	
		$I_O = 5\text{ mA to }1\text{ A}$		12	100		
		$I_O = 250\text{ mA to }750\text{ mA}$		5	50		
I_Q	Quiescent Current	$T_J = +25^{\circ}\text{C}$		5	6	mA	
ΔI_Q	Quiescent Current Change	$I_O = 5\text{ mA to }1\text{ A}$			0.5	mA	
		$V_I = 12.8\text{ V to }25\text{ V}$, $I_O = 500\text{ mA}$			0.8		
		$V_I = 13\text{ V to }26\text{ V}$, $T_J = +25^{\circ}\text{C}$			0.5		
$\Delta V_O/\Delta T$	Output Voltage Drift ⁽²⁵⁾	$I_O = 5\text{ mA}$		-1		mV/ $^{\circ}\text{C}$	
V_N	Output Noise Voltage	$f = 10\text{ Hz to }100\text{ kHz}$, $T_A = +25^{\circ}\text{C}$		58		μV	
RR	Ripple Rejection ⁽²⁵⁾	$f = 120\text{ Hz}$, $V_O = 500\text{ mA}$, $V_I = 14\text{ V to }24\text{ V}$		62		dB	
V_{DROP}	Dropout Voltage	$I_O = 1\text{ A}$, $T_J = +25^{\circ}\text{C}$		2		V	
R_O	Output Resistance ⁽²⁵⁾	$f = 1\text{ kHz}$		17		m Ω	
I_{SC}	Short-Circuit Current	$V_I = 35\text{ V}$, $T_J = +25^{\circ}\text{C}$		250		mA	
I_{PK}	Peak Current ⁽²⁵⁾	$T_J = +25^{\circ}\text{C}$		2.2		A	

Notes:

24. Load and line regulation are specified at constant junction temperature. Changes in V_O due to heating effects must be taken into account separately. Pulse testing with low duty is used.

25. These parameters, although guaranteed, are not 100% tested in production.

Electrical Characteristics (LM7812A)Refer to the test circuit, $0^{\circ}\text{C} < T_J < 125^{\circ}\text{C}$, $I_O = 1\text{ A}$, $V_I = 19\text{ V}$, $C_I = 0.33\text{ }\mu\text{F}$, $C_O = 0.1\text{ }\mu\text{F}$, unless otherwise specified.

Symbol	Parameter	Conditions	Min.	Typ.	Max.	Unit	
V_O	Output Voltage	$T_J = +25^{\circ}\text{C}$	11.75	12.00	12.25	V	
		$I_O = 5\text{ mA to }1\text{ A}$, $P_O \leq 15\text{ W}$, $V_I = 14.8\text{ V to }27\text{ V}$	11.50	12.00	12.50		
Regline	Line Regulation ⁽²⁶⁾	$V_I = 14.8\text{ V to }30\text{ V}$, $I_O = 500\text{ mA}$		10	120	mV	
		$V_I = 16\text{ V to }22\text{ V}$		4	120		
		$T_J = +25^{\circ}\text{C}$	$V_I = 14.5\text{ V to }27\text{ V}$		10		120
			$V_I = 16\text{ V to }22\text{ V}$		3		60
Regload	Load Regulation ⁽²⁶⁾	$T_J = +25^{\circ}\text{C}$, $I_O = 5\text{ mA to }1.5\text{ A}$		12	100	mV	
		$I_O = 5\text{ mA to }1\text{ A}$		12	100		
		$I_O = 250\text{ mA to }750\text{ mA}$		5	50		
I_Q	Quiescent Current	$T_J = +25^{\circ}\text{C}$		5	6	mA	
ΔI_Q	Quiescent Current Change	$I_O = 5\text{ mA to }1\text{ A}$			0.5	mA	
		$V_I = 14\text{ V to }27\text{ V}$, $I_O = 500\text{ mA}$			0.8		
		$V_I = 15\text{ V to }30\text{ V}$, $T_J = +25^{\circ}\text{C}$			0.8		
$\Delta V_O/\Delta T$	Output Voltage Drift ⁽²⁷⁾	$I_O = 5\text{ mA}$		-1		mV/ $^{\circ}\text{C}$	
V_N	Output Noise Voltage	$f = 10\text{ Hz to }100\text{ kHz}$, $T_A = +25^{\circ}\text{C}$		76		μV	
RR	Ripple Rejection ⁽²⁷⁾	$f = 120\text{ Hz}$, $V_O = 500\text{ mA}$, $V_I = 14\text{ V to }24\text{ V}$		60		dB	
V_{DROP}	Dropout Voltage	$I_O = 1\text{ A}$, $T_J = +25^{\circ}\text{C}$		2		V	
R_O	Output Resistance ⁽²⁷⁾	$f = 1\text{ kHz}$		18		m Ω	
I_{SC}	Short-Circuit Current	$V_I = 35\text{ V}$, $T_J = +25^{\circ}\text{C}$		250		mA	
I_{PK}	Peak Current ⁽²⁷⁾	$T_J = +25^{\circ}\text{C}$		2.2		A	

Notes:

26. Load and line regulation are specified at constant junction temperature. Changes in V_O due to heating effects must be taken into account separately. Pulse testing with low duty is used.

27. These parameters, although guaranteed, are not 100% tested in production.

Electrical Characteristics (LM7815A)Refer to the test circuit, $0^{\circ}\text{C} < T_J < 125^{\circ}\text{C}$, $I_O = 1\text{ A}$, $V_I = 23\text{ V}$, $C_I = 0.33\text{ }\mu\text{F}$, $C_O = 0.1\text{ }\mu\text{F}$, unless otherwise specified.

Symbol	Parameter	Conditions	Min.	Typ.	Max.	Unit	
V_O	Output Voltage	$T_J = +25^{\circ}\text{C}$	14.75	15.00	15.30	V	
		$I_O = 5\text{ mA to }1\text{ A}$, $P_O \leq 15\text{ W}$, $V_I = 17.7\text{ V to }30\text{ V}$	14.40	15.00	15.60		
Regline	Line Regulation ⁽²⁸⁾	$V_I = 17.4\text{ V to }30\text{ V}$, $I_O = 500\text{ mA}$		10	150	mV	
		$V_I = 20\text{ V to }26\text{ V}$		5	150		
		$T_J = +25^{\circ}\text{C}$	$V_I = 17.5\text{ V to }30\text{ V}$		11		150
			$V_I = 20\text{ V to }26\text{ V}$		3		75
Regload	Load Regulation ⁽²⁸⁾	$T_J = +25^{\circ}\text{C}$, $I_O = 5\text{ mA to }1.5\text{ A}$		12	100	mV	
		$I_O = 5\text{ mA to }1\text{ A}$		12	100		
		$I_O = 250\text{ mA to }750\text{ mA}$		5	50		
I_Q	Quiescent Current	$T_J = +25^{\circ}\text{C}$		5.2	6.0	mA	
ΔI_Q	Quiescent Current Change	$I_O = 5\text{ mA to }1\text{ A}$			0.5	mA	
		$V_I = 17.5\text{ V to }30\text{ V}$, $I_O = 500\text{ mA}$			0.8		
		$V_I = 17.5\text{ V to }30\text{ V}$, $T_J = +25^{\circ}\text{C}$			0.8		
$\Delta V_O/\Delta T$	Output Voltage Drift ⁽²⁹⁾	$I_O = 5\text{ mA}$		-1		mV/ $^{\circ}\text{C}$	
V_N	Output Noise Voltage	$f = 10\text{ Hz to }100\text{ kHz}$, $T_A = +25^{\circ}\text{C}$		90		μV	
RR	Ripple Rejection ⁽²⁹⁾	$f = 120\text{ Hz}$, $V_O = 500\text{ mA}$, $V_I = 18.5\text{ V to }28.5\text{ V}$		58		dB	
V_{DROP}	Dropout Voltage	$I_O = 1\text{ A}$, $T_J = +25^{\circ}\text{C}$		2		V	
R_O	Output Resistance ⁽²⁹⁾	$f = 1\text{ kHz}$		19		m Ω	
I_{SC}	Short-Circuit Current	$V_I = 35\text{ V}$, $T_J = +25^{\circ}\text{C}$		250		mA	
I_{PK}	Peak Current ⁽²⁹⁾	$T_J = +25^{\circ}\text{C}$		2.2		A	

Notes:

28. Load and line regulation are specified at constant junction temperature. Changes in V_O due to heating effects must be taken into account separately. Pulse testing with low duty is used.

29. These parameters, although guaranteed, are not 100% tested in production.

Typical Performance Characteristics



Figure 2. Quiescent Current

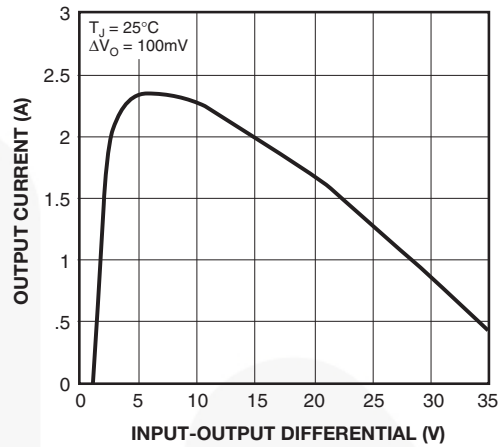

Figure 3. Peak Output Current



Figure 4. Output Voltage

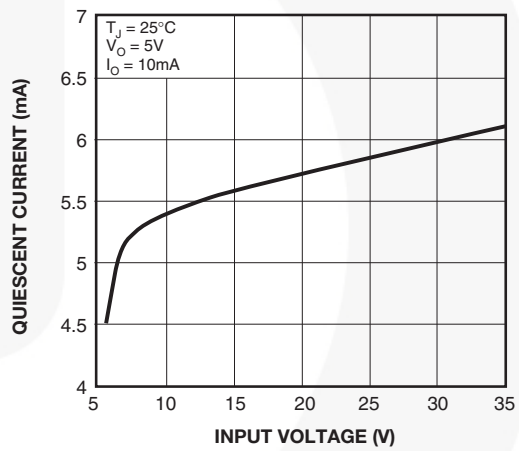

Figure 5. Quiescent Current

Typical Applications



Figure 6. DC Parameters



Figure 7. Load Regulation



Figure 8. Ripple Rejection

Typical Applications (Continued)

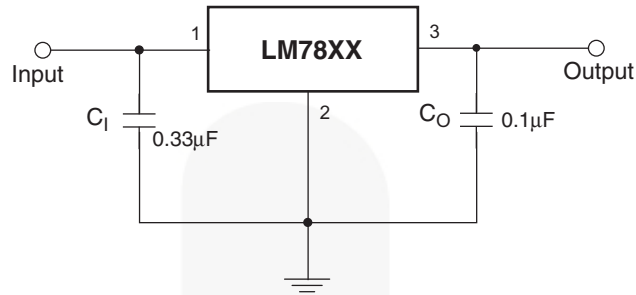

Figure 9. Fixed-Output Regulator



Figure 10. Constant Current Regulator

Notes:

- 29. To specify an output voltage, substitute voltage value for "XX". A common ground is required between the input and the output voltage. The input voltage must remain typically 2.0 V above the output voltage even during the low point on the input ripple voltage.
- 30. C₁ is required if regulator is located an appreciable distance from power supply filter.
- 31. C₀ improves stability and transient response.



Figure 11. Circuit for Increasing Output Voltage

Typical Applications (Continued)

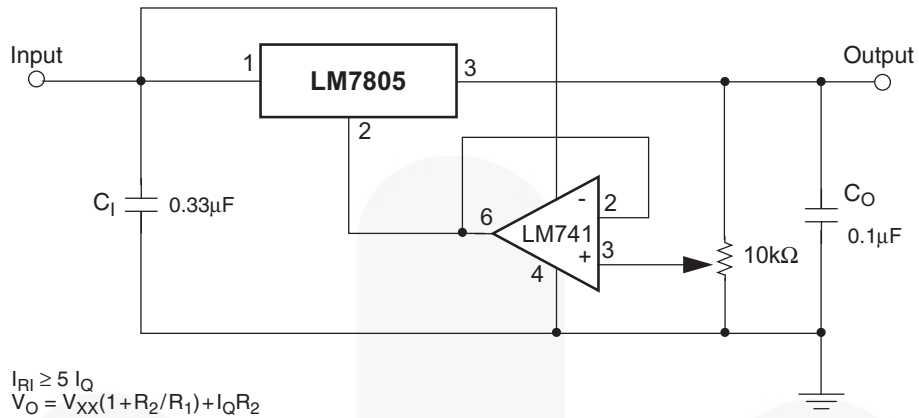

Figure 12. Adjustable Output Regulator (7 V to 30 V)



Figure 13. High-Current Voltage Regulator



Figure 14. High Output Current with Short-Circuit Protection

Typical Applications (Continued)

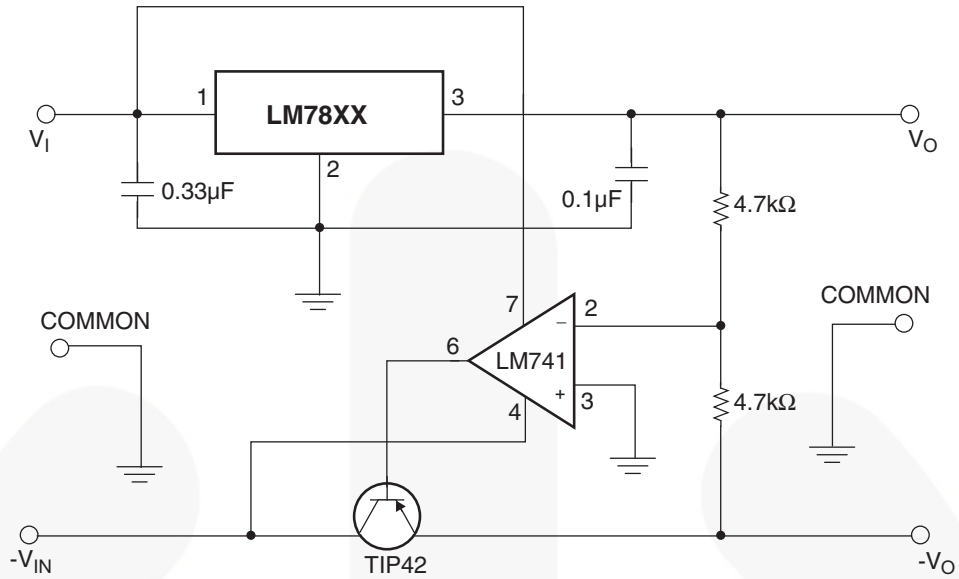

Figure 15. Tracking Voltage Regulator



Figure 16. Split Power Supply (± 15 V - 1 A)

Typical Applications (Continued)



Figure 17. Negative Output Voltage Circuit



Figure 18. Switching Regulator

Physical Dimensions



Figure 19. TO-220, MOLDED, 3-LEAD, JEDEC VARIATION AB (ACTIVE)





TRADEMARKS

The following includes registered and unregistered trademarks and service marks, owned by Fairchild Semiconductor and/or its global subsidiaries, and is not intended to be an exhaustive list of all such trademarks.

AccuPower™
 Awinda®
 AX-CAP®
 BitSiC™
 Build it Now™
 CorePLUS™
 CorePOWER™
 CROSSVOLT™
 CTL™
 Current Transfer Logic™
 DEUXPEED®
 Dual Cool™
 EcoSPARK®
 EfficientMax™
 ESBC™

 Fairchild®
 Fairchild Semiconductor®
 FACT Quiet Series™
 FACT®
 FAST®
 FastvCore™
 FETBench™
 FPS™

F-PFS™
 FRFET®
 Global Power ResourceSM
 GreenBridge™
 Green FPS™
 Green FPS™ e-Series™
 Gmax™
 GTO™
 IntelliMAX™
 ISOPLANAR™
 Making Small Speakers Sound Louder and Better™
 MegaBuck™
 MICROCOPPLER™
 MicroFET™
 MicroPak™
 MicroPak2™
 MillerDrive™
 MotionMax™
 MotionGrid®
 MTi®
 MTx®
 MVN®
 mWSaver®
 OptoHiT™

 PowerTrench®
 PowerXS™
 Programmable Active Droop™
 QFET®
 QS™
 Quiet Series™
 RapidConfigure™

 Saving our world, 1mW/W/kW at a time™
 SignalWise™
 SmartMax™
 SMART START™
 Solutions for Your Success™
 SPM®
 STEALTH™
 SuperFET®
 SuperSOT™-3
 SuperSOT™-6
 SuperSOT™-8
 SupreMOS®
 SyncFET™
 Sync-Lock™

 SYSTEM GENERAL®
 TinyBoost®
 TinyBuck®
 TinyCalc™
 TinyLogic®
 TINYOPTO™
 TinyPower™
 TinyPWM™
 TinyWire™
 TranSiC™
 TriFault Detect™
 TRUECURRENT®*
 μSerDes™

 UHC®
 Ultra FRFET™
 UniFET™
 VCX™
 VisualMax™
 VoltagePlus™
 XS™
 Xsens™
 仙童™

* Trademarks of System General Corporation, used under license by Fairchild Semiconductor.

DISCLAIMER

FAIRCHILD SEMICONDUCTOR RESERVES THE RIGHT TO MAKE CHANGES WITHOUT FURTHER NOTICE TO ANY PRODUCTS HEREIN TO IMPROVE RELIABILITY, FUNCTION, OR DESIGN. TO OBTAIN THE LATEST, MOST UP-TO-DATE DATASHEET AND PRODUCT INFORMATION, VISIT OUR WEBSITE AT [HTTP://WWW.FAIRCHILDSEMI.COM](http://www.fairchildsemi.com). FAIRCHILD DOES NOT ASSUME ANY LIABILITY ARISING OUT OF THE APPLICATION OR USE OF ANY PRODUCT OR CIRCUIT DESCRIBED HEREIN; NEITHER DOES IT CONVEY ANY LICENSE UNDER ITS PATENT RIGHTS, NOR THE RIGHTS OF OTHERS. THESE SPECIFICATIONS DO NOT EXPAND THE TERMS OF FAIRCHILD'S WORLDWIDE TERMS AND CONDITIONS, SPECIFICALLY THE WARRANTY THEREIN, WHICH COVERS THESE PRODUCTS.

LIFE SUPPORT POLICY

FAIRCHILD'S PRODUCTS ARE NOT AUTHORIZED FOR USE AS CRITICAL COMPONENTS IN LIFE SUPPORT DEVICES OR SYSTEMS WITHOUT THE EXPRESS WRITTEN APPROVAL OF FAIRCHILD SEMICONDUCTOR CORPORATION.

As used herein:

1. Life support devices or systems are devices or systems which, (a) are intended for surgical implant into the body or (b) support or sustain life, and (c) whose failure to perform when properly used in accordance with instructions for use provided in the labeling, can be reasonably expected to result in a significant injury of the user.
2. A critical component in any component of a life support, device, or system whose failure to perform can be reasonably expected to cause the failure of the life support device or system, or to affect its safety or effectiveness.

ANTI-COUNTERFEITING POLICY

Fairchild Semiconductor Corporation's Anti-Counterfeiting Policy. Fairchild's Anti-Counterfeiting Policy is also stated on our external website, www.fairchildsemi.com, under Sales Support.

Counterfeiting of semiconductor parts is a growing problem in the industry. All manufacturers of semiconductor products are experiencing counterfeiting of their parts. Customers who inadvertently purchase counterfeit parts experience many problems such as loss of brand reputation, substandard performance, failed applications, and increased cost of production and manufacturing delays. Fairchild is taking strong measures to protect ourselves and our customers from the proliferation of counterfeit parts. Fairchild strongly encourages customers to purchase Fairchild parts either directly from Fairchild or from Authorized Fairchild Distributors who are listed by country on our web page cited above. Products customers buy either from Fairchild directly or from Authorized Fairchild Distributors are genuine parts, have full traceability, meet Fairchild's quality standards for handling and storage and provide access to Fairchild's full range of up-to-date technical and product information. Fairchild and our Authorized Distributors will stand behind all warranties and will appropriately address any warranty issues that may arise. Fairchild will not provide any warranty coverage or other assistance for parts bought from Unauthorized Sources. Fairchild is committed to combat this global problem and encourage our customers to do their part in stopping this practice by buying direct or from authorized distributors.

PRODUCT STATUS DEFINITIONS

Definition of Terms

Datasheet Identification	Product Status	Definition
Advance Information	Formative / In Design	Datasheet contains the design specifications for product development. Specifications may change in any manner without notice.
Preliminary	First Production	Datasheet contains preliminary data; supplementary data will be published at a later date. Fairchild Semiconductor reserves the right to make changes at any time without notice to improve design.
No Identification Needed	Full Production	Datasheet contains final specifications. Fairchild Semiconductor reserves the right to make changes at any time without notice to improve the design.
Obsolete	Not In Production	Datasheet contains specifications on a product that is discontinued by Fairchild Semiconductor. The datasheet is for reference information only.

Rev. 171

Mouser Electronics

Authorized Distributor

Click to View Pricing, Inventory, Delivery & Lifecycle Information:

[Fairchild Semiconductor:](#)

[LM7806CT](#)