



Is Now Part of



**ON Semiconductor®**

To learn more about ON Semiconductor, please visit our website at  
[www.onsemi.com](http://www.onsemi.com)

ON Semiconductor and the ON Semiconductor logo are trademarks of Semiconductor Components Industries, LLC dba ON Semiconductor or its subsidiaries in the United States and/or other countries. ON Semiconductor owns the rights to a number of patents, trademarks, copyrights, trade secrets, and other intellectual property. A listing of ON Semiconductor's product/patent coverage may be accessed at [www.onsemi.com/site/pdf/Patent-Marking.pdf](http://www.onsemi.com/site/pdf/Patent-Marking.pdf). ON Semiconductor reserves the right to make changes without further notice to any products herein. ON Semiconductor makes no warranty, representation or guarantee regarding the suitability of its products for any particular purpose, nor does ON Semiconductor assume any liability arising out of the application or use of any product or circuit, and specifically disclaims any and all liability, including without limitation special, consequential or incidental damages. Buyer is responsible for its products and applications using ON Semiconductor products, including compliance with all laws, regulations and safety requirements or standards, regardless of any support or applications information provided by ON Semiconductor. "Typical" parameters which may be provided in ON Semiconductor data sheets and/or specifications can and do vary in different applications and actual performance may vary over time. All operating parameters, including "Typicals" must be validated for each customer application by customer's technical experts. ON Semiconductor does not convey any license under its patent rights nor the rights of others. ON Semiconductor products are not designed, intended, or authorized for use as a critical component in life support systems or any FDA Class 3 medical devices or medical devices with a same or similar classification in a foreign jurisdiction or any devices intended for implantation in the human body. Should Buyer purchase or use ON Semiconductor products for any such unintended or unauthorized application, Buyer shall indemnify and hold ON Semiconductor and its officers, employees, subsidiaries, affiliates, and distributors harmless against all claims, costs, damages, and expenses, and reasonable attorney fees arising out of, directly or indirectly, any claim of personal injury or death associated with such unintended or unauthorized use, even if such claim alleges that ON Semiconductor was negligent regarding the design or manufacture of the part. ON Semiconductor is an Equal Opportunity/Affirmative Action Employer. This literature is subject to all applicable copyright laws and is not for resale in any manner.



November 2014

# SMBJ5V0(C)A - SMBJ170(C)A 600 Watt Transient Voltage Suppressors

## Features

- Glass-Passivated Junction
- 600 W Peak Pulse Power Capability on 10/1000  $\mu$ s Waveform.
- Excellent Clamping Capability
- Low-Incremental Surge Resistance
- Fast Response Time: Typically Less than 1.0 ps from 0 V to BV minimum for Unidirectional and 5.0 ns for Bidirectional
- Typical  $I_R$  Less than 1.0  $\mu$ A Above 10 V
- UL Certificate #E258596

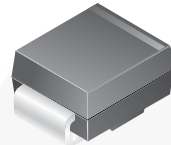

**SMB/DO-214AA**

Band denotes cathode on unidirectional devices only. No band on bi-directional devices. Bi-directional types have CA suffix where electrical characteristics apply in both directions suitable for bi-directional applications.

## Absolute Maximum Ratings

Stresses exceeding the absolute maximum ratings may damage the device. The device may not function or be operable above the recommended operating conditions and stressing the parts to these levels is not recommended. In addition, extended exposure to stresses above the recommended operating conditions may affect device reliability. The absolute maximum ratings are stress ratings only. Values are at  $T_A = 25^\circ\text{C}$  unless otherwise noted.

Symbol	Parameter	Value	Unit
$P_{PPM}$	Peak Pulse Power Dissipation on 10/1000 $\mu$ s Waveform	600	W
$I_{PPM}$	Peak Pulse Current on 10/1000 $\mu$ s Waveform	See Table	A
$I_{FSM}$	Non-Repetitive Peak Forward Surge Current Superimposed on Rated Load (JEDEC Method) <sup>(1)</sup>	100	A
$T_{STG}$	Storage Temperature Range	-55 to 150	$^\circ\text{C}$
$T_J$	Operating Junction Temperature Range	-55 to 150	$^\circ\text{C}$

### Note:

1. Measured on 8.3 ms single half-sine wave or equivalent square wave: duty cycle = 4 pulses per minute maximum.

SMBJ5V0(C)A - SMBJ170(C)A — 600 Watt Transient Voltage Suppressors

## Electrical Characteristics

Values are at  $T_A = 25^\circ\text{C}$  unless otherwise noted.

Uni-Directional Bi-Directional (C) Device	Part Marking <sup>(2)</sup>	Reverse Stand-Off Voltage $V_{RWM}$ (V)	Breakdown Voltage $V_{BR}$ (V)		Test Current $I_T$ (mA)	Clamping Voltage at $I_{PPM}$ $V_C$ (V)	Peak Pulse Current $I_{PPM}$ (A)	Reverse Leakage at $V_{RWM}$ $I_R$ ( $\mu\text{A}$ ) <sup>(3)</sup>
			Min.	Max.				
SMBJ5V0(C)A	KE	5.0	6.40	7.00	10	9.2	65.2	800
SMBJ6V0(C)A	KG	6.0	6.67	7.37	10	10.3	58.3	800
SMBJ6V5(C)A	KK	6.5	7.22	7.98	10	11.2	53.6	500
SMBJ7V0(C)A	KM	7.0	7.78	8.60	10	12.0	50.0	200
SMBJ7V5(C)A	KP	7.5	8.33	9.21	1	12.9	46.5	100
SMBJ8V0(C)A	KR	8.0	8.89	9.83	1	13.6	44.1	50
SMBJ8V5(C)A	KT	8.5	9.44	10.4	1	14.4	41.7	20
SMBJ9V0(C)A	KV	9.0	10.0	11.1	1	15.4	39.0	10
SMBJ10(C)A	KX	10	11.1	12.8	1	17.0	35.3	5
SMBJ11(C)A	KZ	11	12.2	13.5	1	18.2	33.0	5
SMBJ12(C)A	LE	12	13.3	14.7	1	19.9	30.2	5
SMBJ13(C)A	LG	13	14.4	15.9	1	21.5	27.9	5
SMBJ14(C)A	LK	14	15.6	17.2	1	23.2	25.9	5
SMBJ15(C)A	LM	15	16.7	18.5	1	24.4	24.6	5
SMBJ16(C)A	LP	16	17.8	19.7	1	26.0	23.1	5
SMBJ17(C)A	LR	17	18.9	20.9	1	27.6	21.7	5
SMBJ18(C)A	LT	18	20.0	22.1	1	29.2	20.5	5
SMBJ20(C)A	LV	20	22.2	24.5	1	32.4	18.5	5
SMBJ22(C)A	LX	22	24.4	26.9	1	35.5	16.9	5
SMBJ24(C)A	LZ	24	26.7	29.5	1	38.9	15.4	5
SMBJ26(C)A	ME	26	28.9	31.9	1	42.1	14.3	5
SMBJ28(C)A	MG	28	31.1	34.4	1	45.4	13.2	5
SMBJ30(C)A	MK	30	33.3	36.8	1	48.4	12.4	5
SMBJ33(C)A	MM	33	36.7	40.6	1	53.3	11.3	5
SMBJ36(C)A	MP	36	40.0	44.2	1	58.1	10.3	5
SMBJ40(C)A	MR	40	44.4	49.1	1	64.5	9.3	5
SMBJ43(C)A	MT	43	47.8	52.8	1	69.4	8.6	5
SMBJ45(C)A	MV	45	50.0	55.3	1	72.7	8.3	5
SMBJ48(C)A	MX	48	53.3	58.9	1	77.4	7.8	5
SMBJ51(C)A	MZ	51	56.7	62.7	1	82.4	7.3	5
SMBJ54(C)A	NE	54	60.0	66.3	1	87.1	6.9	5
SMBJ58(C)A	NG	58	64.4	71.2	1	93.6	6.4	5
SMBJ60(C)A	NK	60	66.7	73.7	1	96.8	6.2	5
SMBJ64(C)A	NM	64	71.1	78.6	1	103.0	5.8	5
SMBJ70(C)A	NP	70	77.8	86.0	1	113.0	5.3	5
SMBJ75(C)A	NR	75	83.3	92.1	1	121.0	5.0	5
SMBJ78(C)A	NT	78	86.7	95.8	1	126.0	4.8	5

### Notes:

2. Color band denotes cathode on unidirectional devices only. No color band on bidirectional devices.
3. For bidirectional parts with  $V_{RWM} < 10$  V, the  $I_R$  max limit is doubled.

**Electrical Characteristics** (Continued)Values are at  $T_A = 25^\circ\text{C}$  unless otherwise noted.

Uni-Directional Bi-Directional (C) Device	Part Marking <sup>(2)</sup>	Reverse Stand-Off Voltage $V_{RWM}$ (V)	Breakdown Voltage $V_{BR}$ (V)		Test Current $I_T$ (mA)	Clamping Voltage at $I_{PPM}$ $V_C$ (V)	Peak Pulse Current $I_{PPM}$ (A)	Reverse Leakage at $V_{RWM}$ $I_R$ ( $\mu\text{A}$ ) <sup>(3)</sup>
			Min.	Max.				
SMBJ85(C)A	NV	85	94.4	104.0	1	137.0	4.4	5
SMBJ90(C)A	NX	90	100.0	111.0	1	146.0	4.1	5
SMBJ100(C)A	NZ	100	111.0	123.0	1	162.0	3.7	5
SMBJ110(C)A	PE	110	122.0	135.0	1	177.0	3.4	5
SMBJ120(C)A	PG	120	133.0	147.0	1	193.0	3.1	5
SMBJ130(C)A	PK	130	144.0	159.0	1	209.0	2.9	5
SMBJ150(C)A	PM	150	167.0	185.0	1	243.0	2.5	5
SMBJ160(C)A	PP	160	178.0	197.0	1	259.0	2.3	5
SMBJ170(C)A	PR	170	189.0	209.0	1	275.0	2.2	5

**Notes:**

- Color band denotes cathode on unidirectional devices only. No color band on bidirectional devices.
- For bidirectional parts with  $V_{RWM} < 10$  V, the  $I_R$  max limit is doubled.

## Typical Performance Characteristics

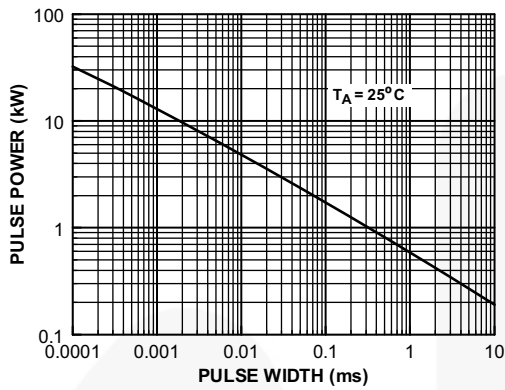

Figure 1. Peak Pulse Power Rating Curve

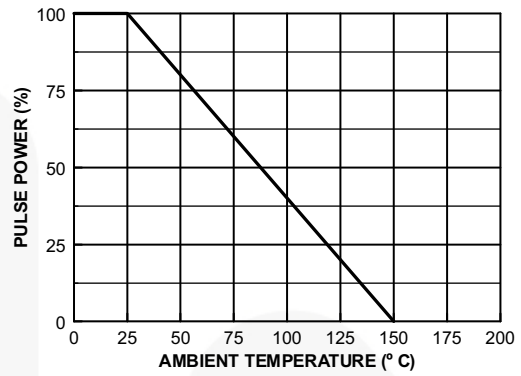

Figure 2. Pulse Derating Curve

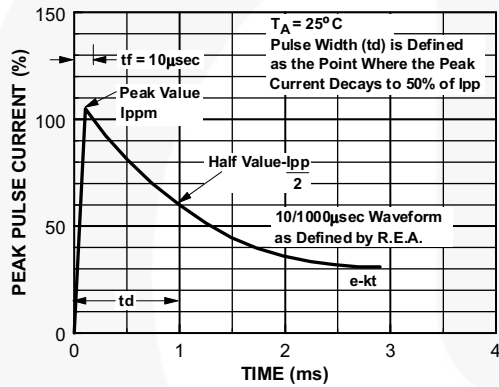

Figure 3. Pulse Waveform

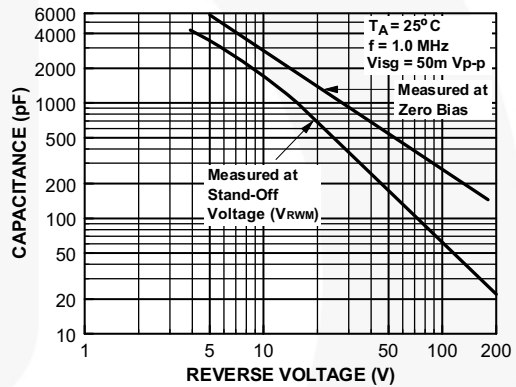

Figure 4. Junction Capacitance

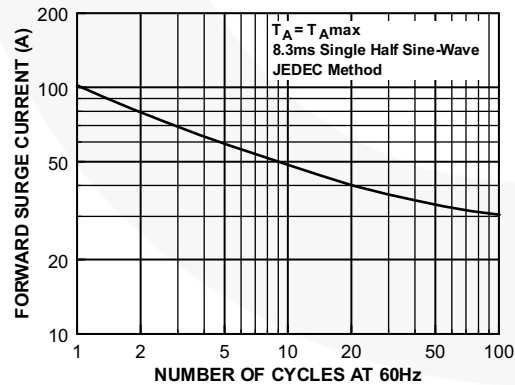
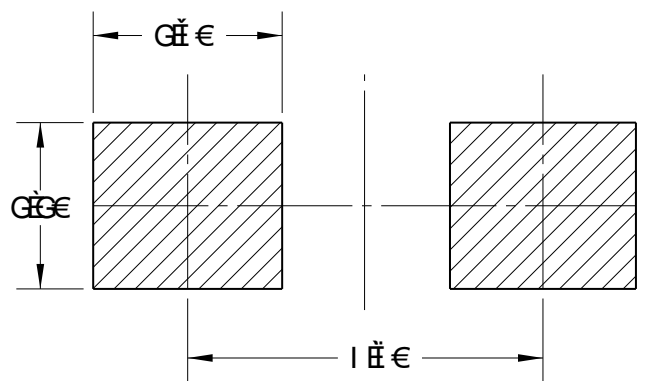
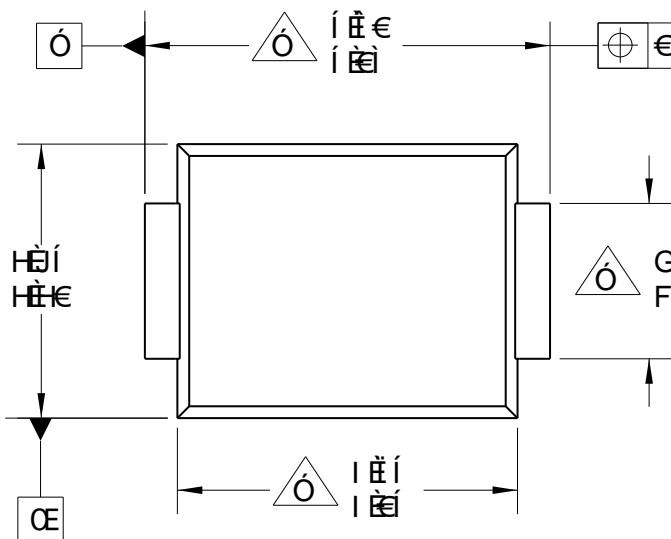

Figure 5. Non-Repetitive Surge Current

VP:ΦΑΙΡΧΙΛΟ ΣΗΜΑ ΕΜΠΟΡΙΟΥ ΚΑΙ ΕΛΕΓΧΟΣ ΤΩΝ ΠΩΣΕΩΝ ΤΩΝ ΕΚΜΕΤΑΛΛΕΥΜΕΝΩΝ ΠΡΟΪΟΝΤΩΝ ΤΗΣ ΕΤΑΙΡΙΑΣ FAIRCHILD SEMICONDUCTOR. Η ΕΤΑΙΡΙΑ ΔΕΧΕΤΑΙ ΚΑΘΑΡΑ ΑΠΑΝΤΗΣΕΙΣ ΚΑΙ ΠΡΟΤΥΠΑ ΚΑΤΑ ΤΗΝ ΑΡΧΗ ΤΗΣ ΚΑΛΗΣ ΠΡΟΒΛΕΨΗΣ. ΟΙ ΔΙΑΔΙΔΑΧΕΣ ΚΑΙ ΟΙ ΔΙΑΔΙΔΑΧΕΣ ΤΗΣ ΕΤΑΙΡΙΑΣ ΔΕΧΟΝΤΑΙ ΟΤΙ ΟΙ ΠΡΟΪΟΝΤΕΣ ΤΗΣ ΕΤΑΙΡΙΑΣ ΕΙΝΑΙ ΚΑΤΑ ΤΗΝ ΑΡΧΗ ΤΗΣ ΚΑΛΗΣ ΠΡΟΒΛΕΨΗΣ ΚΑΙ ΟΤΙ ΟΙ ΠΡΟΪΟΝΤΕΣ ΤΗΣ ΕΤΑΙΡΙΑΣ ΔΕΧΟΝΤΑΙ ΟΤΙ ΟΙ ΠΡΟΪΟΝΤΕΣ ΤΗΣ ΕΤΑΙΡΙΑΣ ΕΙΝΑΙ ΚΑΤΑ ΤΗΝ ΑΡΧΗ ΤΗΣ ΚΑΛΗΣ ΠΡΟΒΛΕΨΗΣ.

ΥΠΟΧΩΡΗΤΩ			
ΠΡΟΪ	ΟΝΟΜΑ ΠΡΟΪΟΝΤΟΣ	ΟΜΟΤΗΤΑ	ΟΡΓΑΝΙΣΜΟΣ
F	ΥΠΟΧΩΡΗΤΩ ΑΠΛΟ	FJT 05 ΓΕΕ	ΥΠΟΧΩΡΗΤΩ



ΣΧΗΜΑ ΤΗΣ ΠΡΟΒΛΕΨΗΣ ΤΩΝ ΔΙΑΣΤΑΣΕΩΝ

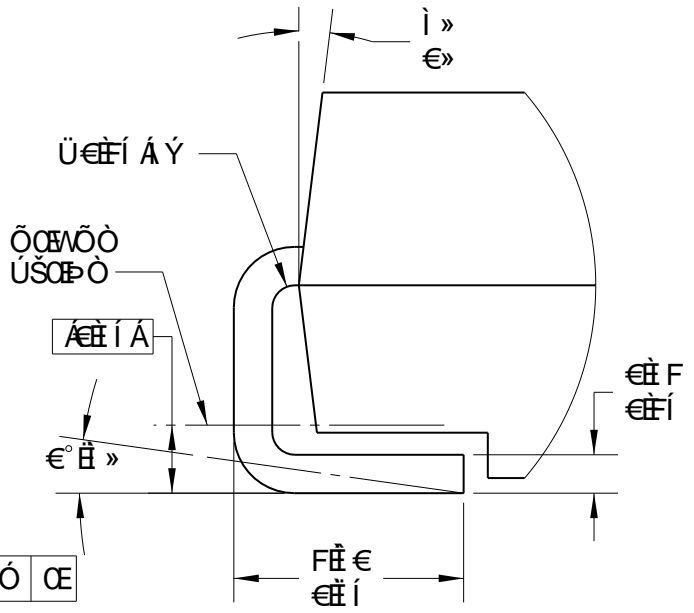
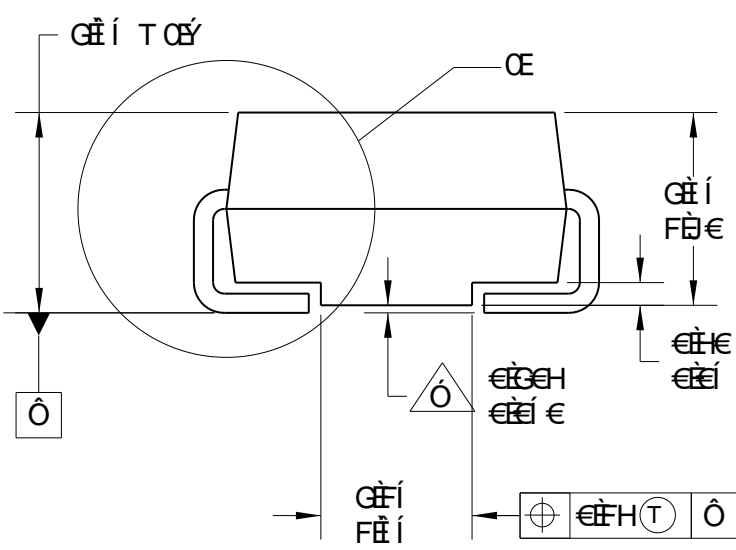

ΣΧΗΜΑ ΤΗΣ ΠΡΟΒΛΕΨΗΣ ΤΩΝ ΔΙΑΣΤΑΣΕΩΝ

ΒΡΕΛΛΕΤΕ

ΑΝ ΤΟ ΕΝΤΕΛΟΝ ΤΗΣ ΠΡΟΒΛΕΨΗΣ ΔΕΧΕΤΑΙ ΕΝΔΕΙΞΕΙΣ ΤΩΝ ΔΙΑΣΤΑΣΕΩΝ ΤΗΣ ΕΤΑΙΡΙΑΣ FAIRCHILD SEMICONDUCTOR. Η ΕΤΑΙΡΙΑ ΔΕΧΕΤΑΙ ΚΑΘΑΡΑ ΑΠΑΝΤΗΣΕΙΣ ΚΑΙ ΠΡΟΤΥΠΑ ΚΑΤΑ ΤΗΝ ΑΡΧΗ ΤΗΣ ΚΑΛΗΣ ΠΡΟΒΛΕΨΗΣ. ΟΙ ΔΙΑΔΙΔΑΧΕΣ ΚΑΙ ΟΙ ΔΙΑΔΙΔΑΧΕΣ ΤΗΣ ΕΤΑΙΡΙΑΣ ΔΕΧΟΝΤΑΙ ΟΤΙ ΟΙ ΠΡΟΪΟΝΤΕΣ ΤΗΣ ΕΤΑΙΡΙΑΣ ΕΙΝΑΙ ΚΑΤΑ ΤΗΝ ΑΡΧΗ ΤΗΣ ΚΑΛΗΣ ΠΡΟΒΛΕΨΗΣ ΚΑΙ ΟΤΙ ΟΙ ΠΡΟΪΟΝΤΕΣ ΤΗΣ ΕΤΑΙΡΙΑΣ ΔΕΧΟΝΤΑΙ ΟΤΙ ΟΙ ΠΡΟΪΟΝΤΕΣ ΤΗΣ ΕΤΑΙΡΙΑΣ ΕΙΝΑΙ ΚΑΤΑ ΤΗΝ ΑΡΧΗ ΤΗΣ ΚΑΛΗΣ ΠΡΟΒΛΕΨΗΣ.

ΕΠΙΧΡΗΣΗ	ΟΜΟΤΗΤΑ		<p>ΣΧΗΜΑ ΤΗΣ ΠΡΟΒΛΕΨΗΣ ΤΩΝ ΔΙΑΣΤΑΣΕΩΝ</p> <p>ΟΝΟΜΑ ΠΡΟΪΟΝΤΟΣ</p> <p>ΟΝΟΜΑ ΠΡΟΪΟΝΤΟΣ</p>	<p>ΥΠΟΧΩΡΗΤΩ</p> <p>FJT 05 ΓΕΕ</p>	<p>ΥΠΟΧΩΡΗΤΩ</p> <p>F</p>
ΕΠΙΧΡΗΣΗ	ΟΝΟΜΑ ΠΡΟΪΟΝΤΟΣ				
ΕΠΙΧΡΗΣΗ	ΟΝΟΜΑ ΠΡΟΪΟΝΤΟΣ				
ΥΠΟΧΩΡΗΤΩ			<p>ΥΠΟΧΩΡΗΤΩ</p> <p>FJT 05 ΓΕΕ</p>	<p>ΥΠΟΧΩΡΗΤΩ</p> <p>F</p>	<p>ΥΠΟΧΩΡΗΤΩ</p> <p>F</p>



**TRADEMARKS**

The following includes registered and unregistered trademarks and service marks, owned by Fairchild Semiconductor and/or its global subsidiaries, and is not intended to be an exhaustive list of all such trademarks.

- AccuPower™
- AttitudeEngine™
- Awinda®
- AX-CAP®\*
- BitSiC™
- Build it Now™
- CorePLUS™
- CorePOWER™
- CROSSVOL™
- CTL™
- Current Transfer Logic™
- DEUXPEED®
- Dual Cool™
- EcoSPARK®
- EfficientMax™
- ESBC™
- F**™
- Fairchild®
- Fairchild Semiconductor®
- FACT Quiet Series™
- FACT®
- FastvCore™
- FETBench™
- FPS™
- F-PFS™
- FRFET®
- Global Power Resource<sup>SM</sup>
- GreenBridge™
- Green FPS™
- Green FPS™ e-Series™
- Gmax™
- GTO™
- IntelliMAX™
- ISOPLANAR™
- Making Small Speakers Sound Louder and Better™
- MegaBuck™
- MICROCOUPLER™
- MicroFET™
- MicroPak™
- MicroPak2™
- MillerDrive™
- MotionMax™
- MotionGrid®
- MTi®
- MTx®
- MVN®
- mWSaver®
- OptoHiT™
- OPTOLOGIC®
- OPTOPLANAR®
- ®
- Power Supply WebDesigner™
- PowerTrench®
- PowerXS™
- Programmable Active Droop™
- QFET®
- QS™
- Quiet Series™
- RapidConfigure™
- ™
- Saving our world, 1mW/W/kW at a time™
- SignalWise™
- SmartMax™
- SMART START™
- Solutions for Your Success™
- SPM®
- STEALTH™
- SuperFET®
- SuperSOT™-3
- SuperSOT™-6
- SuperSOT™-8
- SupreMOS®
- SyncFET™
- Sync-Lock™
- ®
- TinyBoost®
- TinyBuck®
- TinyCalc™
- TinyLogic®
- TINYOPTO™
- TinyPower™
- TinyPWM™
- TinyWire™
- TranSiC™
- TriFault Detect™
- TRUECURRENT®\*
- μSerDes™
- ™
- UHC®
- Ultra FRFET™
- UniFET™
- VcX™
- VisualMax™
- VoltagePlus™
- XS™
- Xsens™
- 仙童®

\* Trademarks of System General Corporation, used under license by Fairchild Semiconductor.

**DISCLAIMER**

FAIRCHILD SEMICONDUCTOR RESERVES THE RIGHT TO MAKE CHANGES WITHOUT FURTHER NOTICE TO ANY PRODUCTS HEREIN TO IMPROVE RELIABILITY, FUNCTION, OR DESIGN. TO OBTAIN THE LATEST, MOST UP-TO-DATE DATASHEET AND PRODUCT INFORMATION, VISIT OUR WEBSITE AT [HTTP://WWW.FAIRCHILDSEMI.COM](http://www.fairchildsemi.com). FAIRCHILD DOES NOT ASSUME ANY LIABILITY ARISING OUT OF THE APPLICATION OR USE OF ANY PRODUCT OR CIRCUIT DESCRIBED HEREIN; NEITHER DOES IT CONVEY ANY LICENSE UNDER ITS PATENT RIGHTS, NOR THE RIGHTS OF OTHERS. THESE SPECIFICATIONS DO NOT EXPAND THE TERMS OF FAIRCHILD'S WORLDWIDE TERMS AND CONDITIONS, SPECIFICALLY THE WARRANTY THEREIN, WHICH COVERS THESE PRODUCTS.

**AUTHORIZED USE**

Unless otherwise specified in this data sheet, this product is a standard commercial product and is not intended for use in applications that require extraordinary levels of quality and reliability. This product may not be used in the following applications, unless specifically approved in writing by a Fairchild officer: (1) automotive or other transportation, (2) military/aerospace, (3) any safety critical application – including life critical medical equipment – where the failure of the Fairchild product reasonably would be expected to result in personal injury, death or property damage. Customer's use of this product is subject to agreement of this Authorized Use policy. In the event of an unauthorized use of Fairchild's product, Fairchild accepts no liability in the event of product failure. In other respects, this product shall be subject to Fairchild's Worldwide Terms and Conditions of Sale, unless a separate agreement has been signed by both Parties.

**ANTI-COUNTERFEITING POLICY**

Fairchild Semiconductor Corporation's Anti-Counterfeiting Policy. Fairchild's Anti-Counterfeiting Policy is also stated on our external website, [www.fairchildsemi.com](http://www.fairchildsemi.com), under Terms of Use

Counterfeiting of semiconductor parts is a growing problem in the industry. All manufacturers of semiconductor products are experiencing counterfeiting of their parts. Customers who inadvertently purchase counterfeit parts experience many problems such as loss of brand reputation, substandard performance, failed applications, and increased cost of production and manufacturing delays. Fairchild is taking strong measures to protect ourselves and our customers from the proliferation of counterfeit parts. Fairchild strongly encourages customers to purchase Fairchild parts either directly from Fairchild or from Authorized Fairchild Distributors who are listed by country on our web page cited above. Products customers buy either from Fairchild directly or from Authorized Fairchild Distributors are genuine parts, have full traceability, meet Fairchild's quality standards for handling and storage and provide access to Fairchild's full range of up-to-date technical and product information. Fairchild and our Authorized Distributors will stand behind all warranties and will appropriately address any warranty issues that may arise. Fairchild will not provide any warranty coverage or other assistance for parts bought from Unauthorized Sources. Fairchild is committed to combat this global problem and encourage our customers to do their part in stopping this practice by buying direct or from authorized distributors.

**PRODUCT STATUS DEFINITIONS**

**Definition of Terms**

Datasheet Identification	Product Status	Definition
Advance Information	Formative / In Design	Datasheet contains the design specifications for product development. Specifications may change in any manner without notice.
Preliminary	First Production	Datasheet contains preliminary data; supplementary data will be published at a later date. Fairchild Semiconductor reserves the right to make changes at any time without notice to improve design.
No Identification Needed	Full Production	Datasheet contains final specifications. Fairchild Semiconductor reserves the right to make changes at any time without notice to improve the design.
Obsolete	Not In Production	Datasheet contains specifications on a product that is discontinued by Fairchild Semiconductor. The datasheet is for reference information only.

Rev. I77

# Mouser Electronics

Authorized Distributor

Click to View Pricing, Inventory, Delivery & Lifecycle Information:

[Fairchild Semiconductor:](#)

[SMBJ75A](#)