

# IRF7455PbF

## SMPS MOSFET

HEXFET® Power MOSFET

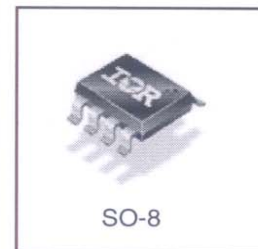
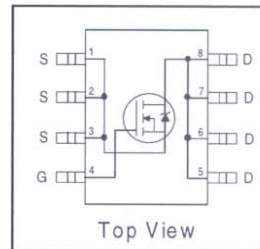
### Applications

- High Frequency DC-DC Converters with Synchronous Rectification
- Lead-Free

$V_{DSS}$	$R_{DS(on) \max}$	$I_D$
30V	0.0075Ω	15A

### Benefits

- Ultra-Low  $R_{DS(on)}$  at 4.5V  $V_{GS}$
- Low Charge and Low Gate Impedance to Reduce Switching Losses
- Fully Characterized Avalanche Voltage and Current



### Absolute Maximum Ratings

Symbol	Parameter	Max.	Units
$V_{DS}$	Drain-Source Voltage	30	V
$V_{GS}$	Gate-to-Source Voltage	± 12	V
$I_D @ T_A = 25^\circ\text{C}$	Continuous Drain Current, $V_{GS} @ 10\text{V}$	15	A
$I_D @ T_A = 70^\circ\text{C}$	Continuous Drain Current, $V_{GS} @ 10\text{V}$	12	
$I_{DM}$	Pulsed Drain Current <sup>①</sup>	120	
$P_D @ T_A = 25^\circ\text{C}$	Maximum Power Dissipation <sup>③</sup>	2.5	W
$P_D @ T_A = 70^\circ\text{C}$	Maximum Power Dissipation <sup>③</sup>	1.6	W
	Linear Derating Factor	0.02	W/°C
$T_J, T_{STG}$	Junction and Storage Temperature Range	-55 to + 150	°C

### Thermal Resistance

	Parameter	Max.	Units
$R_{\theta JA}$	Maximum Junction-to-Ambient <sup>④</sup>	50	°C/W

### Typical SMPS Topologies

- Telecom 48V Input Converters with Logic-Level Driven Synchronous Rectifiers

Notes ① through ④ are on page 8

### Static @ $T_J = 25^\circ\text{C}$ (unless otherwise specified)

	Parameter	Min.	Typ.	Max.	Units	Conditions
$V_{(BR)DSS}$	Drain-to-Source Breakdown Voltage	30	—	—	V	$V_{GS} = 0V, I_D = 250\mu A$
$\Delta V_{(BR)DSS}/\Delta T_J$	Breakdown Voltage Temp. Coefficient	—	0.029	—	V/ $^\circ\text{C}$	Reference to $25^\circ\text{C}, I_D = 1\text{mA}$
$R_{DS(on)}$	Static Drain-to-Source On-Resistance	—	0.0060	0.0075	$\Omega$	$V_{GS} = 10V, I_D = 15A$ ④
		—	0.0069	0.009		$V_{GS} = 4.5V, I_D = 12A$ ④
		—	0.010	0.020		$V_{GS} = 2.8V, I_D = 3.5A$ ④
$V_{GS(th)}$	Gate Threshold Voltage	0.6	—	2.0	V	$V_{DS} = V_{GS}, I_D = 250\mu A$
$I_{DSS}$	Drain-to-Source Leakage Current	—	—	20	$\mu A$	$V_{DS} = 24V, V_{GS} = 0V$
		—	—	100		$V_{DS} = 24V, V_{GS} = 0V, T_J = 125^\circ\text{C}$
$I_{GSS}$	Gate-to-Source Forward Leakage	—	—	200	nA	$V_{GS} = 12V$
	Gate-to-Source Reverse Leakage	—	—	-200		$V_{GS} = -12V$

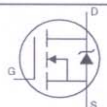
### Dynamic @ $T_J = 25^\circ\text{C}$ (unless otherwise specified)

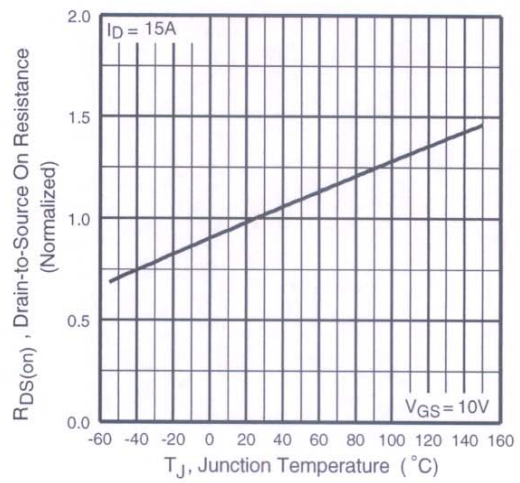
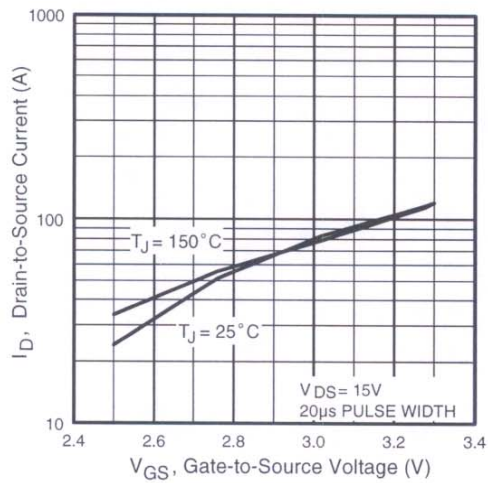
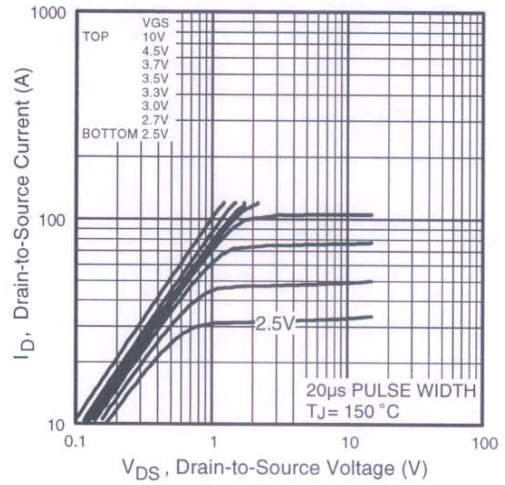
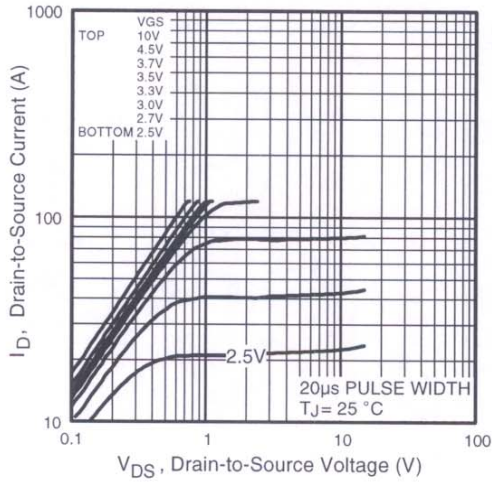
	Parameter	Min.	Typ.	Max.	Units	Conditions
$g_{fs}$	Forward Transconductance	44	—	—	S	$V_{DS} = 10V, I_D = 15A$
$Q_g$	Total Gate Charge	—	37	56	nC	$I_D = 15A$ $V_{DS} = 24V$ $V_{GS} = 5.0V$ , ③
$Q_{gs}$	Gate-to-Source Charge	—	8.9	13		
$Q_{gd}$	Gate-to-Drain ("Miller") Charge	—	13	20		
$t_{d(on)}$	Turn-On Delay Time	—	17	—		
$t_r$	Rise Time	—	18	—	ns	$V_{DD} = 15V$ $I_D = 1.0A$ $R_G = 6.0\Omega$ $V_{GS} = 4.5V$ ③
$t_{d(off)}$	Turn-Off Delay Time	—	51	—		
$t_f$	Fall Time	—	44	—		
$C_{iss}$	Input Capacitance	—	3480	—	pF	$V_{GS} = 0V$ $V_{DS} = 25V$ $f = 1.0\text{MHz}$
$C_{oss}$	Output Capacitance	—	870	—		
$C_{riss}$	Reverse Transfer Capacitance	—	100	—		

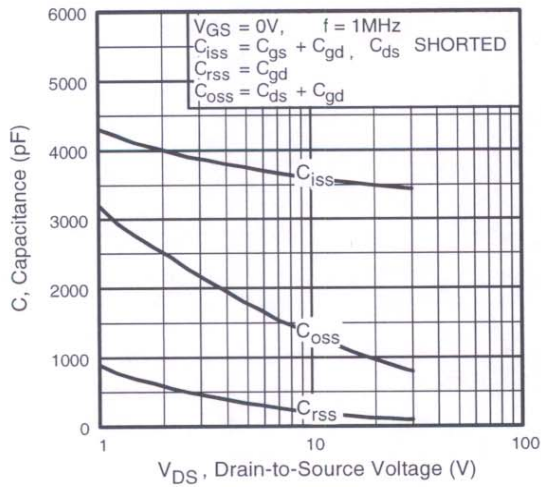
### Avalanche Characteristics

	Parameter	Typ.	Max.	Units
$E_{AS}$	Single Pulse Avalanche Energy②	—	200	mJ
$I_{AR}$	Avalanche Current①	—	15	A
$E_{AR}$	Repetitive Avalanche Energy①	—	0.25	mJ

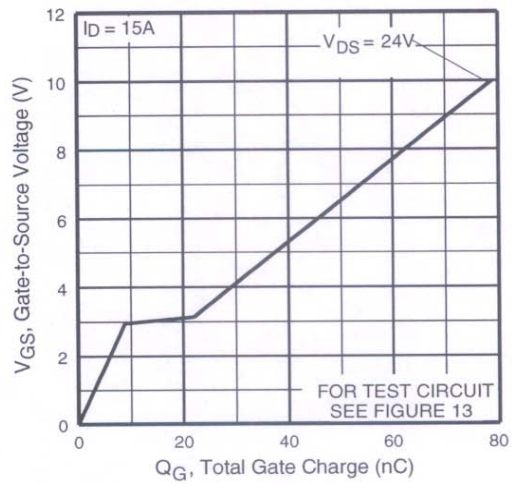
### Diode Characteristics

	Parameter	Min.	Typ.	Max.	Units	Conditions
$I_S$	Continuous Source Current (Body Diode)	—	—	2.5	A	MOSFET symbol showing the integral reverse p-n junction diode. 
$I_{SM}$	Pulsed Source Current (Body Diode) ①	—	—	120		
$V_{SD}$	Diode Forward Voltage	—	—	1.2	V	$T_J = 25^\circ\text{C}, I_S = 2.5A, V_{GS} = 0V$ ③
$t_{rr}$	Reverse Recovery Time	—	64	96	ns	$T_J = 25^\circ\text{C}, I_F = 2.5A$
$Q_{rr}$	Reverse Recovery Charge	—	99	150	nC	$di/dt = 100A/\mu s$ ③

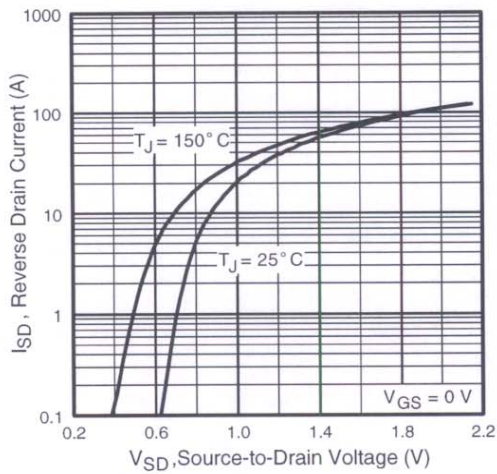




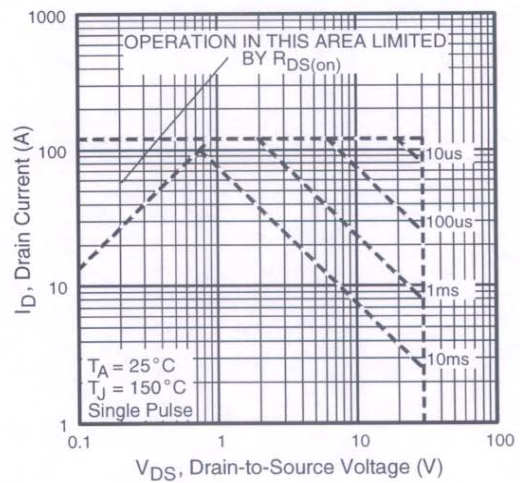
**Fig 5.** Typical Capacitance Vs. Drain-to-Source Voltage



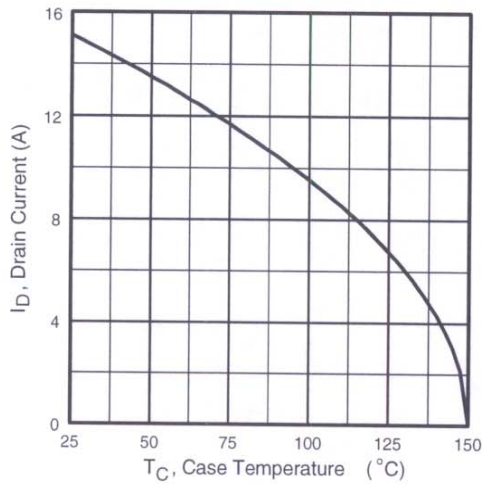
**Fig 6.** Typical Gate Charge Vs. Gate-to-Source Voltage



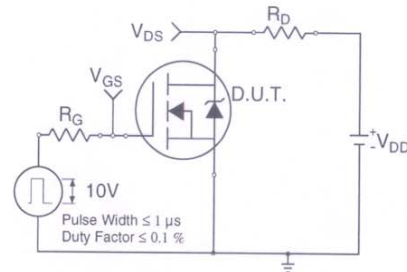
**Fig 7.** Typical Source-Drain Diode Forward Voltage



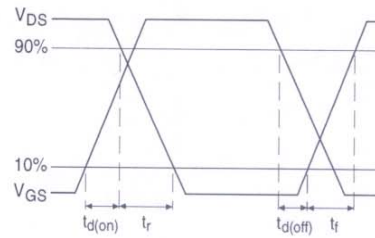
**Fig 8.** Maximum Safe Operating Area



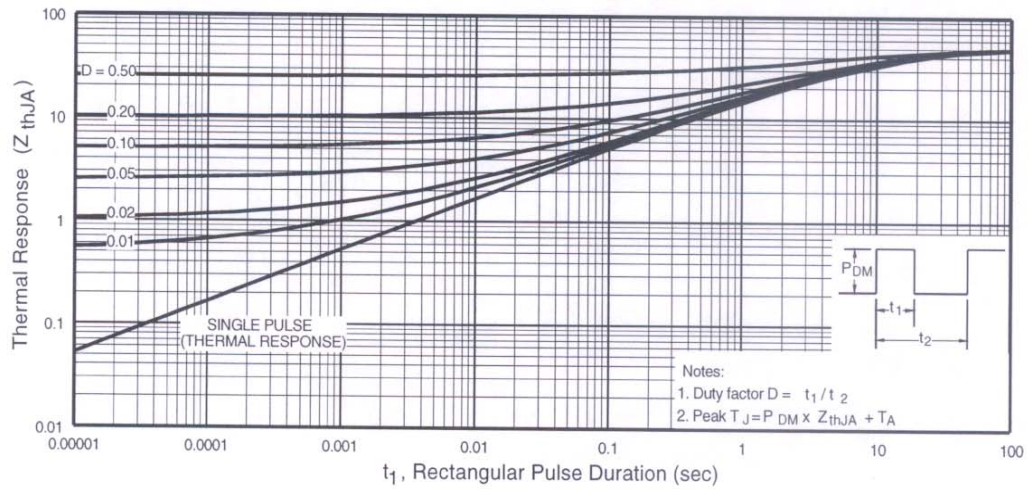
**Fig 9.** Maximum Drain Current Vs. Case Temperature



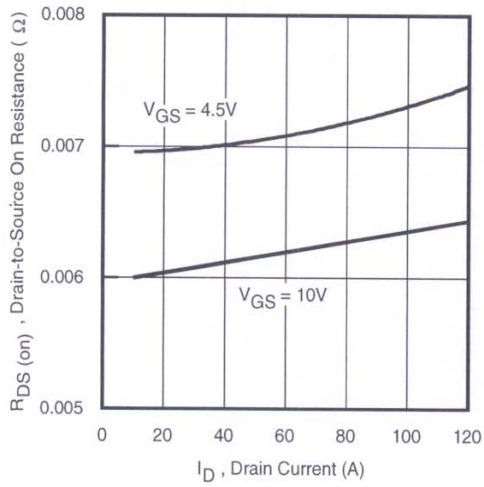
**Fig 10a.** Switching Time Test Circuit



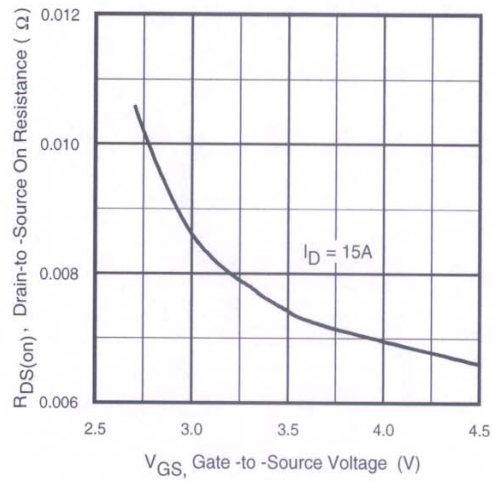
**Fig 10b.** Switching Time Waveforms



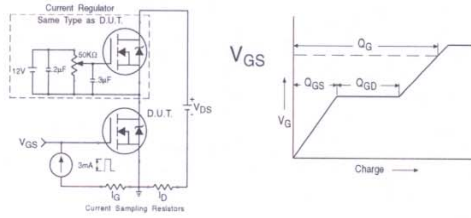
**Fig 11.** Maximum Effective Transient Thermal Impedance, Junction-to-Ambient



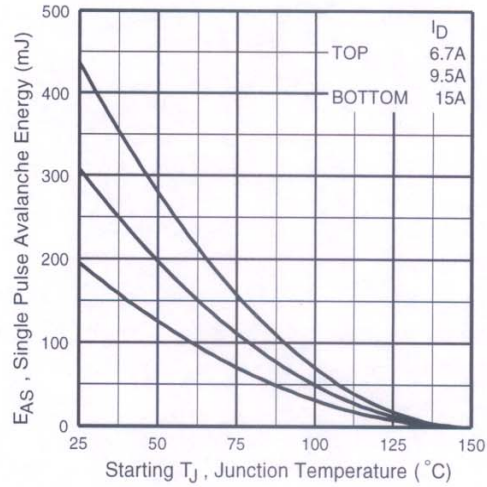
**Fig 12.** On-Resistance Vs. Drain Current



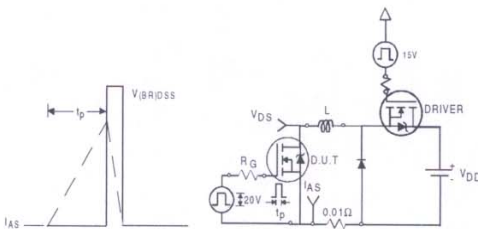
**Fig 13.** On-Resistance Vs. Gate Voltage



**Fig 13a&b.** Basic Gate Charge Test Circuit and Waveform



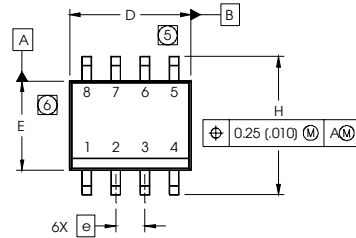
**Fig 14c.** Maximum Avalanche Energy Vs. Drain Current



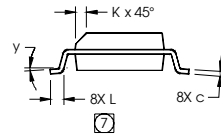
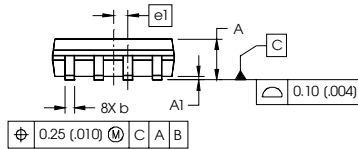
**Fig 14a&b.** Unclamped Inductive Test circuit and Waveforms

## SO-8 Package Outline

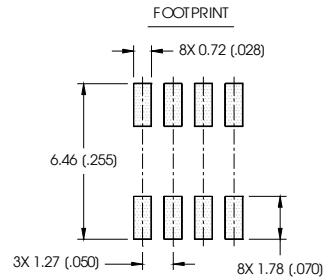
Dimensions are shown in millimeters (inches)



DIM	INCHES		MILLIMETERS	
	MIN	MAX	MIN	MAX
A	.0532	.0688	1.35	1.75
A1	.0040	.0098	0.10	0.25
b	.013	.020	0.33	0.51
c	.0075	.0098	0.19	0.25
D	.189	.1968	4.80	5.00
E	.1497	.1574	3.80	4.00
e	.050 BASIC		1.27 BASIC	
e1	.025 BASIC		0.635 BASIC	
H	.2284	.2440	5.80	6.20
K	.0099	.0196	0.25	0.50
L	.016	.050	0.40	1.27
y	0°	8°	0°	8°

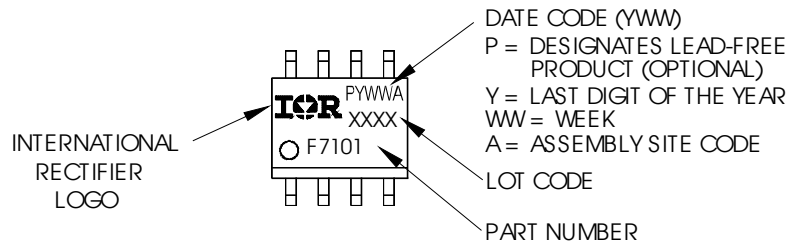


- NOTES:
1. DIMENSIONING & TOLERANCING PER ASME Y14.5M-1994.
  2. CONTROLLING DIMENSION: MILLIMETER
  3. DIMENSIONS ARE SHOWN IN MILLIMETERS (INCHES).
  4. OUTLINE CONFORMS TO JEDEC OUTLINE MS-012AA.
  5. DIMENSION DOES NOT INCLUDE MOLD PROTRUSIONS. MOLD PROTRUSIONS NOT TO EXCEED 0.15 (.006).
  6. DIMENSION DOES NOT INCLUDE MOLD PROTRUSIONS. MOLD PROTRUSIONS NOT TO EXCEED 0.25 (.010).
  7. DIMENSION IS THE LENGTH OF LEAD FOR SOLDERING TO A SUBSTRATE.



## SO-8 Part Marking Information (Lead-Free)

EXAMPLE: THIS IS AN IRF7101 (MOSFET)

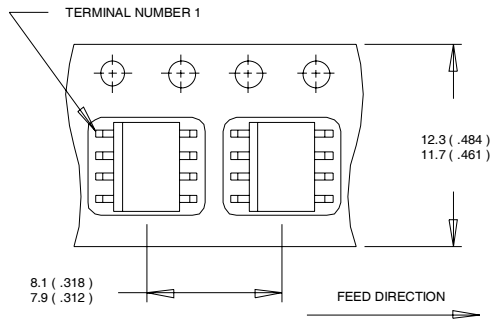


# IRF7455PbF

International  
**IR** Rectifier

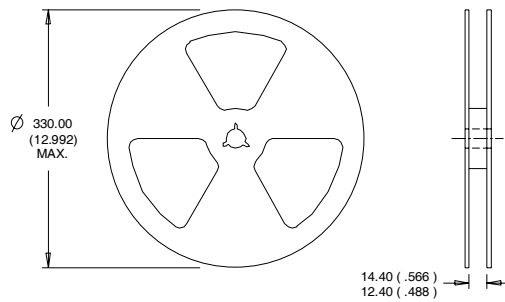
## SO-8 Tape and Reel

Dimensions are shown in millimeters (inches)



**NOTES:**

1. CONTROLLING DIMENSION : MILLIMETER.
2. ALL DIMENSIONS ARE SHOWN IN MILLIMETERS(INCHES).
3. OUTLINE CONFORMS TO EIA-481 & EIA-541.



**NOTES :**

1. CONTROLLING DIMENSION : MILLIMETER.
2. OUTLINE CONFORMS TO EIA-481 & EIA-541.

**Notes:**

- ① Repetitive rating; pulse width limited by max. junction temperature.
- ② Starting  $T_J = 25^\circ\text{C}$ ,  $L = 1.8\text{mH}$   
 $R_G = 25\Omega$ ,  $I_{AS} = 15\text{A}$ .
- ③ Pulse width  $\leq 300\mu\text{s}$ ; duty cycle  $\leq 2\%$ .
- ④ When mounted on 1 inch square copper board,  $t < 10$  sec

Data and specifications subject to change without notice.  
This product has been designed and qualified for the Consumer market.  
Qualifications Standards can be found on IR's Web site.

International  
**IR** Rectifier

**IR WORLD HEADQUARTERS:** 233 Kansas St., El Segundo, California 90245, USA Tel: (310) 252-7105  
TAC Fax: (310) 252-7903

Visit us at [www.irf.com](http://www.irf.com) for sales contact information.06/04

[www.irf.com](http://www.irf.com)



# Mouser Electronics

Authorized Distributor

Click to View Pricing, Inventory, Delivery & Lifecycle Information:

[International Rectifier:](#)

[IRF7455TRPBF](#) [IRF7455PBF](#)