

EasyBRIDGE Modul mit CoolMOS und PressFIT / NTC
EasyBRIDGE module with CoolMOS and PressFIT / NTC

Vorläufige Daten / Preliminary Data

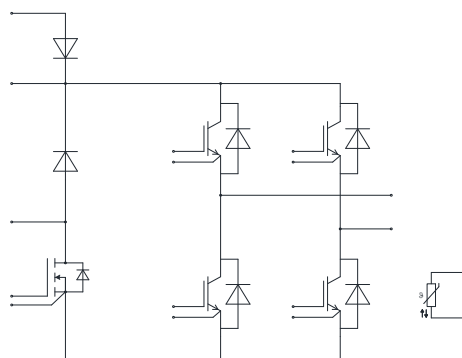
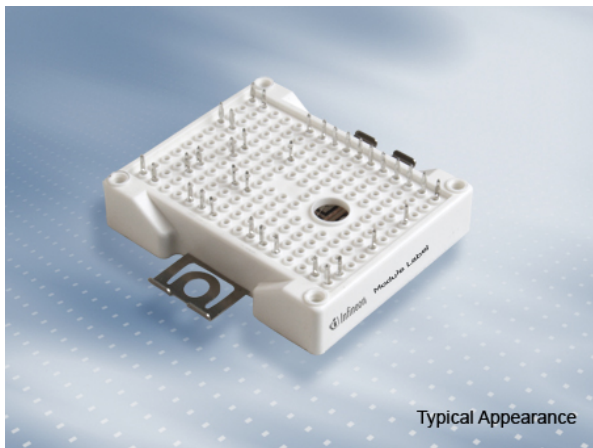

$V_{CES} = 650V$
 $I_{C\ nom} = 50A / I_{CRM} = 100A$

Typische Anwendungen

- Solar Anwendungen

Typical Applications

- Solar Applications

Elektrische Eigenschaften

- Erhöhte Sperrspannungsfestigkeit auf 650V
- Niederinduktives Design
- Niedrige Schaltverluste

Electrical Features

- Increased blocking voltage capability to 650V
- Low Inductive Design
- Low Switching Losses

Mechanische Eigenschaften

- Al₂O₃ Substrat mit kleinem thermischen Widerstand
- Integrierter NTC Temperatur Sensor
- PressFIT Verbindungstechnik

Mechanical Features

- Al₂O₃ Substrate with Low Thermal Resistance
- Integrated NTC temperature sensor
- PressFIT Contact Technology

Module Label Code

Barcode Code 128



DMX - Code



Content of the Code

Content of the Code	Digit
Module Serial Number	1 - 5
Module Material Number	6 - 11
Production Order Number	12 - 19
Datecode (Production Year)	20 - 21
Datecode (Production Week)	22 - 23

prepared by: MB	date of publication: 2014-10-29	
approved by: AKDA	revision: 2.0	UL approved (E83335)



**Vorläufige Daten
Preliminary Data**

**IGBT, Wechselrichter / IGBT, Inverter
Höchstzulässige Werte / Maximum Rated Values**

Kollektor-Emitter-Sperrspannung Collector-emitter voltage	$T_{vj} = 25^{\circ}\text{C}$	V_{CES}	650	V
Implementierter Kollektor-Strom Implemented collector current		I_{CN}	50	A
Kollektor-Dauergleichstrom Continuous DC collector current	$T_C = 75^{\circ}\text{C}, T_{vj\ max} = 175^{\circ}\text{C}$ $T_C = 25^{\circ}\text{C}, T_{vj\ max} = 175^{\circ}\text{C}$	$I_{C\ nom}$ I_C	25 65	A A
Periodischer Kollektor-Spitzenstrom Repetitive peak collector current	$t_P = 1\ \text{ms}$	I_{CRM}	100	A
Gesamt-Verlustleistung Total power dissipation	$T_C = 25^{\circ}\text{C}, T_{vj\ max} = 175^{\circ}\text{C}$	P_{tot}	215	W
Gate-Emitter-Spitzenspannung Gate-emitter peak voltage		V_{GES}	+/-20	V

Charakteristische Werte / Characteristic Values

			min.	typ.	max.		
Kollektor-Emitter-Sättigungsspannung Collector-emitter saturation voltage	$I_C = 25\ \text{A}, V_{GE} = 15\ \text{V}$ $I_C = 25\ \text{A}, V_{GE} = 15\ \text{V}$ $I_C = 25\ \text{A}, V_{GE} = 15\ \text{V}$	$T_{vj} = 25^{\circ}\text{C}$ $T_{vj} = 125^{\circ}\text{C}$ $T_{vj} = 150^{\circ}\text{C}$	$V_{CE\ sat}$	1,35 1,40 1,40	1,70	V V V	
Gate-Schwellenspannung Gate threshold voltage	$I_C = 0,80\ \text{mA}, V_{CE} = V_{GE}, T_{vj} = 25^{\circ}\text{C}$		V_{Geth}	5,00	5,80	6,50	V
Gateladung Gate charge	$V_{GE} = -15\ \text{V} \dots +15\ \text{V}$		Q_G	0,50			μC
Interner Gatewiderstand Internal gate resistor	$T_{vj} = 25^{\circ}\text{C}$		R_{Gint}	0,0			Ω
Eingangskapazität Input capacitance	$f = 1\ \text{MHz}, T_{vj} = 25^{\circ}\text{C}, V_{CE} = 25\ \text{V}, V_{GE} = 0\ \text{V}$		C_{ies}	2,95			nF
Rückwirkungskapazität Reverse transfer capacitance	$f = 1\ \text{MHz}, T_{vj} = 25^{\circ}\text{C}, V_{CE} = 25\ \text{V}, V_{GE} = 0\ \text{V}$		C_{res}	0,096			nF
Kollektor-Emitter-Reststrom Collector-emitter cut-off current	$V_{CE} = 650\ \text{V}, V_{GE} = 0\ \text{V}, T_{vj} = 25^{\circ}\text{C}$		I_{CES}			1,0	mA
Gate-Emitter-Reststrom Gate-emitter leakage current	$V_{CE} = 0\ \text{V}, V_{GE} = 20\ \text{V}, T_{vj} = 25^{\circ}\text{C}$		I_{GES}			100	nA
Einschaltverzögerungszeit, induktive Last Turn-on delay time, inductive load	$I_C = 25\ \text{A}, V_{CE} = 400\ \text{V}$ $V_{GE} = \pm 15\ \text{V}$ $R_{Gon} = 15\ \Omega$	$T_{vj} = 25^{\circ}\text{C}$ $T_{vj} = 125^{\circ}\text{C}$ $T_{vj} = 150^{\circ}\text{C}$	t_{don}	0,014 0,014 0,014			μs μs μs
Anstiegszeit, induktive Last Rise time, inductive load	$I_C = 25\ \text{A}, V_{CE} = 400\ \text{V}$ $V_{GE} = \pm 15\ \text{V}$ $R_{Gon} = 15\ \Omega$	$T_{vj} = 25^{\circ}\text{C}$ $T_{vj} = 125^{\circ}\text{C}$ $T_{vj} = 150^{\circ}\text{C}$	t_r	0,019 0,02 0,02			μs μs μs
Abschaltverzögerungszeit, induktive Last Turn-off delay time, inductive load	$I_C = 25\ \text{A}, V_{CE} = 400\ \text{V}$ $V_{GE} = \pm 15\ \text{V}$ $R_{Goff} = 20\ \Omega$	$T_{vj} = 25^{\circ}\text{C}$ $T_{vj} = 125^{\circ}\text{C}$ $T_{vj} = 150^{\circ}\text{C}$	t_{doff}	0,29 0,32 0,33			μs μs μs
Fallzeit, induktive Last Fall time, inductive load	$I_C = 25\ \text{A}, V_{CE} = 400\ \text{V}$ $V_{GE} = \pm 15\ \text{V}$ $R_{Goff} = 20\ \Omega$	$T_{vj} = 25^{\circ}\text{C}$ $T_{vj} = 125^{\circ}\text{C}$ $T_{vj} = 150^{\circ}\text{C}$	t_f	0,012 0,012 0,012			μs μs μs
Einschaltverlustenergie pro Puls Turn-on energy loss per pulse	$I_C = 25\ \text{A}, V_{CE} = 400\ \text{V}, L_S = 25\ \text{nH}$ $V_{GE} = \pm 15\ \text{V}, di/dt = 1250\ \text{A}/\mu\text{s} (T_{vj} = 150^{\circ}\text{C})$ $R_{Gon} = 15\ \Omega$	$T_{vj} = 25^{\circ}\text{C}$ $T_{vj} = 125^{\circ}\text{C}$ $T_{vj} = 150^{\circ}\text{C}$	E_{on}	1,05 1,20 1,30			mJ mJ mJ
Abschaltverlustenergie pro Puls Turn-off energy loss per pulse	$I_C = 25\ \text{A}, V_{CE} = 400\ \text{V}, L_S = 25\ \text{nH}$ $V_{GE} = \pm 15\ \text{V}, du/dt = 5000\ \text{V}/\mu\text{s} (T_{vj} = 150^{\circ}\text{C})$ $R_{Goff} = 20\ \Omega$	$T_{vj} = 25^{\circ}\text{C}$ $T_{vj} = 125^{\circ}\text{C}$ $T_{vj} = 150^{\circ}\text{C}$	E_{off}	0,30 0,40 0,45			mJ mJ mJ
Kurzschlußverhalten SC data	$V_{GE} \leq 15\ \text{V}, V_{CC} = 400\ \text{V}$ $V_{CEmax} = V_{CES} - L_{SCE} \cdot di/dt$ $t_P \leq 5\ \mu\text{s}, T_{vj} = 150^{\circ}\text{C}$		I_{SC}	330			A
Wärmewiderstand, Chip bis Gehäuse Thermal resistance, junction to case	pro IGBT / per IGBT		R_{thJC}	0,65	0,70		K/W

prepared by: MB	date of publication: 2014-10-29
approved by: AKDA	revision: 2.0



**Vorläufige Daten
Preliminary Data**

Wärmewiderstand, Gehäuse bis Kühlkörper Thermal resistance, case to heatsink	pro IGBT / per IGBT $\lambda_{\text{Paste}} = 1 \text{ W}/(\text{m}\cdot\text{K})$ / $\lambda_{\text{grease}} = 1 \text{ W}/(\text{m}\cdot\text{K})$	R_{thCH}		0,85		K/W
Temperatur im Schaltbetrieb Temperature under switching conditions		$T_{\text{vj op}}$	-40		150	°C

Diode, Wechselrichter / Diode, Inverter

Höchstzulässige Werte / Maximum Rated Values

Periodische Spitzensperrspannung Repetitive peak reverse voltage	$T_{\text{vj}} = 25^\circ\text{C}$	V_{RRM}		650		V
Implementierter Durchlassstrom Implemented forward current		I_{FN}		30		A
Dauergleichstrom Continuous DC forward current		I_{F}		30		A
Periodischer Spitzenstrom Repetitive peak forward current	$t_{\text{p}} = 1 \text{ ms}$	I_{FRM}		60		A
Grenzlastintegral I^2t - value	$V_{\text{R}} = 0 \text{ V}, t_{\text{p}} = 10 \text{ ms}, T_{\text{vj}} = 125^\circ\text{C}$ $V_{\text{R}} = 0 \text{ V}, t_{\text{p}} = 10 \text{ ms}, T_{\text{vj}} = 150^\circ\text{C}$	I^2t		90,0 82,0		A ² s A ² s

Charakteristische Werte / Characteristic Values

				min.	typ.	max.	
Durchlassspannung Forward voltage	$I_{\text{F}} = 30 \text{ A}, V_{\text{GE}} = 0 \text{ V}$ $I_{\text{F}} = 30 \text{ A}, V_{\text{GE}} = 0 \text{ V}$ $I_{\text{F}} = 30 \text{ A}, V_{\text{GE}} = 0 \text{ V}$	$T_{\text{vj}} = 25^\circ\text{C}$ $T_{\text{vj}} = 125^\circ\text{C}$ $T_{\text{vj}} = 150^\circ\text{C}$	V_{F}		1,60 1,55 1,50	2,00	V V V
Rückstromspitze Peak reverse recovery current	$I_{\text{F}} = 30 \text{ A}, -di_{\text{F}}/dt = 1450 \text{ A}/\mu\text{s} (T_{\text{vj}}=150^\circ\text{C})$ $V_{\text{R}} = 400 \text{ V}$ $V_{\text{GE}} = -15 \text{ V}$	$T_{\text{vj}} = 25^\circ\text{C}$ $T_{\text{vj}} = 125^\circ\text{C}$ $T_{\text{vj}} = 150^\circ\text{C}$	I_{RM}		21,5 26,5 29,0		A A A
Sperrverzögerungsladung Recovered charge	$I_{\text{F}} = 30 \text{ A}, -di_{\text{F}}/dt = 1450 \text{ A}/\mu\text{s} (T_{\text{vj}}=150^\circ\text{C})$ $V_{\text{R}} = 400 \text{ V}$ $V_{\text{GE}} = -15 \text{ V}$	$T_{\text{vj}} = 25^\circ\text{C}$ $T_{\text{vj}} = 125^\circ\text{C}$ $T_{\text{vj}} = 150^\circ\text{C}$	Q_{r}		1,15 2,15 2,45		μC μC μC
Abschaltenergie pro Puls Reverse recovery energy	$I_{\text{F}} = 30 \text{ A}, -di_{\text{F}}/dt = 1450 \text{ A}/\mu\text{s} (T_{\text{vj}}=150^\circ\text{C})$ $V_{\text{R}} = 400 \text{ V}$ $V_{\text{GE}} = -15 \text{ V}$	$T_{\text{vj}} = 25^\circ\text{C}$ $T_{\text{vj}} = 125^\circ\text{C}$ $T_{\text{vj}} = 150^\circ\text{C}$	E_{rec}		0,25 0,46 0,55		mJ mJ mJ
Wärmewiderstand, Chip bis Gehäuse Thermal resistance, junction to case	pro Diode / per diode		R_{thJC}		1,25	1,35	K/W
Wärmewiderstand, Gehäuse bis Kühlkörper Thermal resistance, case to heatsink	pro Diode / per diode $\lambda_{\text{Paste}} = 1 \text{ W}/(\text{m}\cdot\text{K})$ / $\lambda_{\text{grease}} = 1 \text{ W}/(\text{m}\cdot\text{K})$		R_{thCH}		1,35		K/W
Temperatur im Schaltbetrieb Temperature under switching conditions			$T_{\text{vj op}}$	-40		150	°C

prepared by: MB	date of publication: 2014-10-29
approved by: AKDA	revision: 2.0



**Vorläufige Daten
Preliminary Data**

Bypass-Diode / Bypass-Diode

Höchstzulässige Werte / Maximum Rated Values

Periodische Spitzensperrspannung Repetitive peak reverse voltage	$T_{vj} = 25^{\circ}\text{C}$	V_{RRM}	800	V
Durchlassstrom Grenzeffektivwert pro Chip Maximum RMS forward current per chip	$T_C = 80^{\circ}\text{C}$	I_{FRMSM}	50	A
Gleichrichter Ausgang Grenzeffektivstrom Maximum RMS current at rectifier output	$T_C = 80^{\circ}\text{C}$	I_{RMSM}	75	A
Stoßstrom Grenzwert Surge forward current	$t_p = 10\text{ ms}, T_{vj} = 25^{\circ}\text{C}$ $t_p = 10\text{ ms}, T_{vj} = 150^{\circ}\text{C}$	I_{FSM}	800 640	A A
Grenzlastintegral I^2t - value	$t_p = 10\text{ ms}, T_{vj} = 25^{\circ}\text{C}$ $t_p = 10\text{ ms}, T_{vj} = 150^{\circ}\text{C}$	I^2t	3200 2050	A ² s A ² s

Charakteristische Werte / Characteristic Values

			min.	typ.	max.	
Durchlassspannung Forward voltage	$T_{vj} = 150^{\circ}\text{C}, I_F = 50\text{ A}$	V_F		0,90		V
Sperrstrom Reverse current	$T_{vj} = 150^{\circ}\text{C}, V_R = 800\text{ V}$	I_R		0,20		mA
Wärmewiderstand, Chip bis Gehäuse Thermal resistance, junction to case	pro Diode / per diode	R_{thJC}		0,45	0,50	K/W
Wärmewiderstand, Gehäuse bis Kühlkörper Thermal resistance, case to heatsink	pro Diode / per diode $\lambda_{\text{Paste}} = 1\text{ W}/(\text{m}\cdot\text{K})$ / $\lambda_{\text{grease}} = 1\text{ W}/(\text{m}\cdot\text{K})$	R_{thCH}		0,45		K/W
Temperatur im Schaltbetrieb Temperature under switching conditions		$T_{vj\text{ op}}$	-40		150	$^{\circ}\text{C}$

Diode, Hochsetzsteller / Diode, Boost

Höchstzulässige Werte / Maximum Rated Values

Periodische Spitzensperrspannung Repetitive peak reverse voltage	$T_{vj} = 25^{\circ}\text{C}$	V_{RRM}	650	V
Dauergleichstrom Continuous DC forward current		I_F	16	A
Periodischer Spitzenstrom Repetitive peak forward current	$t_p = 1\text{ ms}$	I_{FRM}	32	A
Grenzlastintegral I^2t - value	$V_R = 0\text{ V}, t_p = 10\text{ ms}, T_{vj} = 125^{\circ}\text{C}$	I^2t	32,0	A ² s

Charakteristische Werte / Characteristic Values

			min.	typ.	max.	
Durchlassspannung Forward voltage	$I_F = 16\text{ A}, V_{GE} = 0\text{ V}$ $I_F = 16\text{ A}, V_{GE} = 0\text{ V}$	$T_{vj} = 25^{\circ}\text{C}$ $T_{vj} = 125^{\circ}\text{C}$	V_F	1,50 1,65	1,70	V V
Rückstromspitze Peak reverse recovery current	$I_F = 16\text{ A}, -di_F/dt = 1400\text{ A}/\mu\text{s}$ ($T_{vj}=125^{\circ}\text{C}$) $V_R = 400\text{ V}$	$T_{vj} = 25^{\circ}\text{C}$ $T_{vj} = 125^{\circ}\text{C}$	I_{RM}	10,0 10,5		A A
Sperrverzögerungsladung Recovered charge	$I_F = 16\text{ A}, -di_F/dt = 1400\text{ A}/\mu\text{s}$ ($T_{vj}=125^{\circ}\text{C}$) $V_R = 400\text{ V}$	$T_{vj} = 25^{\circ}\text{C}$ $T_{vj} = 125^{\circ}\text{C}$	Q_r	0,22 0,225		μC μC
Abschaltenergie pro Puls Reverse recovery energy	$I_F = 16\text{ A}, -di_F/dt = 1400\text{ A}/\mu\text{s}$ ($T_{vj}=125^{\circ}\text{C}$) $V_R = 400\text{ V}$	$T_{vj} = 25^{\circ}\text{C}$ $T_{vj} = 125^{\circ}\text{C}$	E_{rec}	0,02 0,02		mJ mJ
Wärmewiderstand, Chip bis Gehäuse Thermal resistance, junction to case	pro Diode / per diode		R_{thJC}	1,20	1,30	K/W
Wärmewiderstand, Gehäuse bis Kühlkörper Thermal resistance, case to heatsink	pro Diode / per diode $\lambda_{\text{Paste}} = 1\text{ W}/(\text{m}\cdot\text{K})$ / $\lambda_{\text{grease}} = 1\text{ W}/(\text{m}\cdot\text{K})$		R_{thCH}	1,15		K/W
Temperatur im Schaltbetrieb Temperature under switching conditions			$T_{vj\text{ op}}$	-40	125	$^{\circ}\text{C}$

prepared by: MB	date of publication: 2014-10-29
approved by: AKDA	revision: 2.0



**Vorläufige Daten
Preliminary Data**

MOSFET / MOSFET

Höchstzulässige Werte / Maximum Rated Values

Drain-Source-Sperrspannung Drain-source breakdown voltage	$T_{vj} = 25^{\circ}\text{C}$	V_{DSS}	650	V
Drain-Gleichstrom DC drain current	$T_C = 100^{\circ}\text{C}$ $T_C = 25^{\circ}\text{C}$	$I_{D, nom}$ I_D	30 50	A A
Gepulster Drainstrom, tp limitiert durch T_{jmax} Pulsed drain current, tp limited by T_{jmax}		$I_{D, puls}$	100	A
Gesamt-Verlustleistung Total power dissipation	$T_C = 25^{\circ}\text{C}$	P_{tot}	520	W
Gate-Source-Spitzenspannung Gate-source peak voltage		V_{GSS}	+/-20	V

Charakteristische Werte / Characteristic Values

			min.	typ.	max.	
Einschaltwiderstand Drain-source on resistance	$I_D = 30\text{ A}, V_{GS} = 10\text{ V}, T_{vj} = 25^{\circ}\text{C}$	$R_{DS, on}$		38,0	42,0	mΩ
Gate-Schwellenspannung Gate threshold voltage	$I_D = 3,30\text{ mA}, V_{DS} = V_{GS}, T_{vj} = 25^{\circ}\text{C}$	$V_{GS(th)}$	2,50	3,00	3,50	V
Gateladung Gate charge	$V_{GS} = 10\text{ V}, V_{DD} = 480\text{ V}$	Q_G		0,33		μC
Interner Gatewiderstand Internal gate resistor	$T_{vj} = 25^{\circ}\text{C}$	R_{Gint}		0,7		Ω
Eingangskapazität Input capacitance	$f = 1\text{ MHz}, T_{vj} = 25^{\circ}\text{C}, V_{DS} = 25\text{ V}, V_{GS} = 0\text{ V}$	C_{iss}		8,00		nF
Ausgangskapazität Output capacitance	$f = 1\text{ MHz}, T_{vj} = 25^{\circ}\text{C}, V_{DS} = 25\text{ V}, V_{GS} = 0\text{ V}$	C_{oss}		7,50		nF
Rückwirkungskapazität Reverse transfer capacitance	$f = 1\text{ MHz}, T_{vj} = 25^{\circ}\text{C}, V_{DS} = 25\text{ V}, V_{GS} = 0\text{ V}$	C_{rss}		0,80		nF
Drain-Source-Reststrom Zero gate voltage drain current	$V_{DS} = 650\text{ V}, V_{GS} = 0\text{ V}, T_{vj} = 25^{\circ}\text{C}$	I_{DSS}			2,00	μA
Gate-Source-Reststrom Gate-source leakage current	$V_{DS} = 0\text{ V}, V_{GS} = 20\text{ V}, T_{vj} = 25^{\circ}\text{C}$	I_{GSS}			100	nA
Einschaltverzögerungszeit, induktive Last Turn on delay time, inductive load	$I_D = 30\text{ A}, V_{DS} = 400\text{ V}$ $V_{GS} = 10\text{ V}$ $R_G = 7,50\text{ }\Omega$	$T_{vj} = 25^{\circ}\text{C}$ $T_{vj} = 125^{\circ}\text{C}$ $T_{vj} = 150^{\circ}\text{C}$		20,0 17,5 16,0		ns
Anstiegszeit, induktive Last Rise time, inductive load	$I_D = 30\text{ A}, V_{DS} = 400\text{ V}$ $V_{GS} = 10\text{ V}$ $R_G = 7,50\text{ }\Omega$	$T_{vj} = 25^{\circ}\text{C}$ $T_{vj} = 125^{\circ}\text{C}$ $T_{vj} = 150^{\circ}\text{C}$		15,0 15,5 16,0		ns
Abschaltverzögerungszeit, induktive Last Turn off delay time, inductive load	$I_D = 30\text{ A}, V_{DS} = 400\text{ V}$ $V_{GS} = 10\text{ V}$ $R_G = 7,50\text{ }\Omega$	$T_{vj} = 25^{\circ}\text{C}$ $T_{vj} = 125^{\circ}\text{C}$ $T_{vj} = 150^{\circ}\text{C}$		210 220 220		ns
Fallzeit, induktive Last Fall time, inductive load	$I_D = 30\text{ A}, V_{DS} = 400\text{ V}$ $V_{GS} = 10\text{ V}$ $R_G = 7,50\text{ }\Omega$	$T_{vj} = 25^{\circ}\text{C}$ $T_{vj} = 125^{\circ}\text{C}$ $T_{vj} = 150^{\circ}\text{C}$		7,50 9,00 9,00		ns
Einschaltverlustenergie pro Puls Turn-on energy loss per pulse	$I_D = 30\text{ A}, V_{DS} = 400\text{ V}, L\sigma = 25\text{ nH}$ $V_{GS} = 10\text{ V}, di/dt = 1600\text{ A}/\mu\text{s} (T_{vj} = 150)$ $R_G = 7,50\text{ }\Omega$	$T_{vj} = 25^{\circ}\text{C}$ $T_{vj} = 125^{\circ}\text{C}$ $T_{vj} = 150^{\circ}\text{C}$		0,32 0,36 0,37		mJ
Abschaltverlustenergie pro Puls Turn-off energy loss per pulse	$I_D = 30\text{ A}, V_{DS} = 400\text{ V}, L\sigma = 25\text{ nH}$ $V_{GS} = 10\text{ V}, du/dt = 19500\text{ V}/\mu\text{s} (T_{vj} = 150)$ $R_G = 7,50\text{ }\Omega$	$T_{vj} = 25^{\circ}\text{C}$ $T_{vj} = 125^{\circ}\text{C}$ $T_{vj} = 150^{\circ}\text{C}$		0,08 0,09 0,095		mJ
Wärmewiderstand, Chip bis Gehäuse Thermal resistance, junction to case		R_{thJC}		0,35	0,40	K/W
Wärmewiderstand, Gehäuse bis Kühlkörper Thermal resistance, case to heatsink	pro MOS-FET / per MOS-FET $\lambda_{Paste} = 1\text{ W}/(\text{m}^2\text{K}) / \lambda_{grease} = 1\text{ W}/(\text{m}^2\text{K})$	R_{thCH}		0,40		K/W
Temperatur im Schaltbetrieb Temperature under switching conditions		$T_{vj, op}$	-40		150	°C

Revers-Diode / reverse-diode

			min.	typ.	max.	
Durchlassspannung Forward voltage	$I_S = 50\text{ A}, V_{GS} = 0\text{ V}$ $I_S = 50\text{ A}, V_{GS} = 0\text{ V}$ $I_S = 50\text{ A}, V_{GS} = 0\text{ V}$	$T_{vj} = 25^{\circ}\text{C}$ $T_{vj} = 125^{\circ}\text{C}$ $T_{vj} = 150^{\circ}\text{C}$		0,85 0,70	1,30	V

prepared by: MB	date of publication: 2014-10-29
approved by: AKDA	revision: 2.0



**Vorläufige Daten
Preliminary Data**

NTC-Widerstand / NTC-Thermistor

Charakteristische Werte / Characteristic Values

			min.	typ.	max.	
Nennwiderstand Rated resistance	$T_C = 25^\circ\text{C}$	R_{25}		5,00		k Ω
Abweichung von R100 Deviation of R100	$T_C = 100^\circ\text{C}, R_{100} = 493 \Omega$	$\Delta R/R$	-5		5	%
Verlustleistung Power dissipation	$T_C = 25^\circ\text{C}$	P_{25}			20,0	mW
B-Wert B-value	$R_2 = R_{25} \exp [B_{25/50}(1/T_2 - 1/(298,15 \text{ K}))]$	$B_{25/50}$		3375		K
B-Wert B-value	$R_2 = R_{25} \exp [B_{25/80}(1/T_2 - 1/(298,15 \text{ K}))]$	$B_{25/80}$		3411		K
B-Wert B-value	$R_2 = R_{25} \exp [B_{25/100}(1/T_2 - 1/(298,15 \text{ K}))]$	$B_{25/100}$		3433		K

Angaben gemäß gültiger Application Note.
Specification according to the valid application note.

Modul / Module

Isolations-Prüfspannung Isolation test voltage	RMS, f = 50 Hz, t = 1 min.	V_{ISOL}		2,5		kV
Innere Isolation Internal isolation	Basisisolation (Schutzklasse 1, EN61140) basic insulation (class 1, IEC 61140)			Al_2O_3		
Kriechstrecke Creepage distance	Kontakt - Kühlkörper / terminal to heatsink Kontakt - Kontakt / terminal to terminal			11,5 6,3		mm
Luftstrecke Clearance	Kontakt - Kühlkörper / terminal to heatsink Kontakt - Kontakt / terminal to terminal			10,0 5,0		mm
Vergleichszahl der Kriechwegbildung Comperative tracking index		CTI		> 200		
			min.	typ.	max.	
Modulstreueinduktivität Stray inductance module		L_{sCE}		17		nH
Modulleitungswiderstand, Anschlüsse - Chip Module lead resistance, terminals - chip	$T_C = 25^\circ\text{C}$, pro Schalter / per switch	R_{CC+EE}		3,00		m Ω
Lagertemperatur Storage temperature		T_{stg}	-40		125	$^\circ\text{C}$
Anpresskraft für mech. Bef. pro Feder mounting force per clamp		F	40	-	80	N
Gewicht Weight		G		39		g

Der Strom im Dauerbetrieb ist auf 25 A effektiv pro Anschlusspin begrenzt.
The current under continuous operation is limited to 25 A rms per connector pin.

prepared by: MB	date of publication: 2014-10-29
approved by: AKDA	revision: 2.0



Vorläufige Daten
Preliminary Data

Ausgangskennlinie IGBT, Wechselrichter (typisch)
output characteristic IGBT, Inverter (typical)

$I_C = f(V_{CE})$
 $V_{GE} = 15\text{ V}$

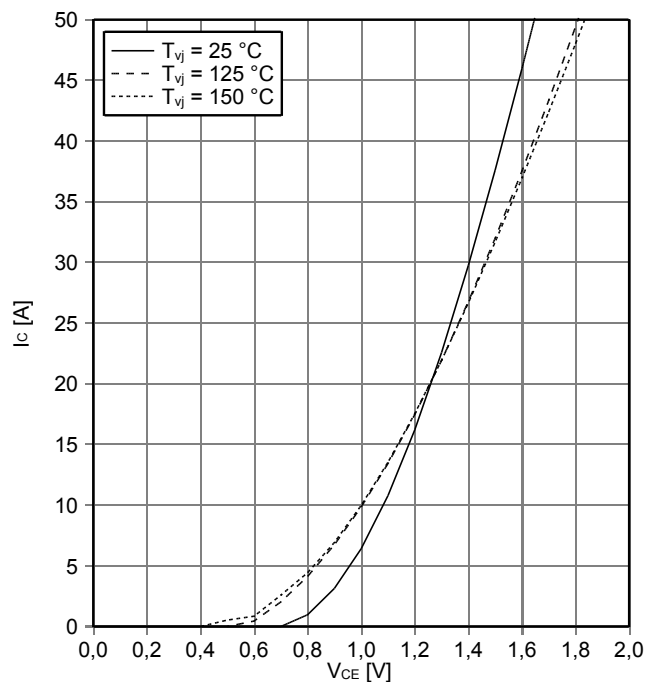

Ausgangskennlinienfeld IGBT, Wechselrichter (typisch)
output characteristic IGBT, Inverter (typical)

$I_C = f(V_{CE})$
 $T_{vj} = 150\text{ °C}$

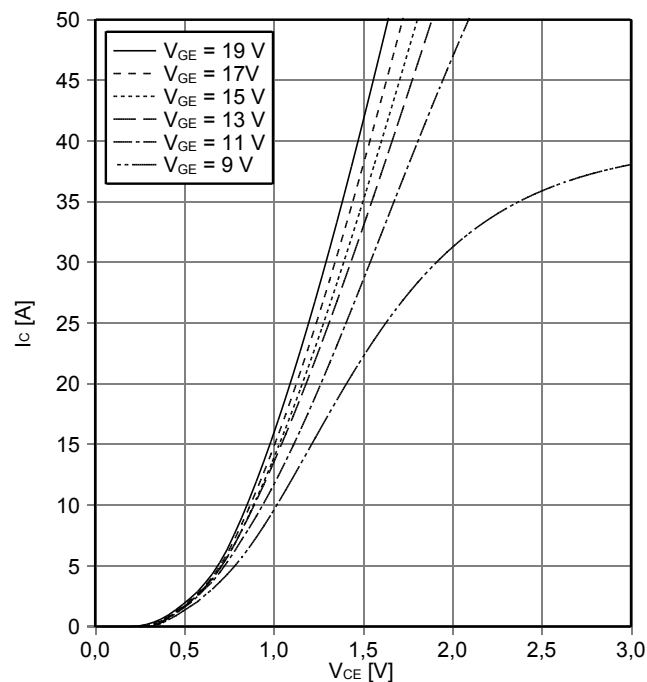

Übertragungscharakteristik IGBT, Wechselrichter (typisch)
transfer characteristic IGBT, Inverter (typical)

$I_C = f(V_{GE})$
 $V_{CE} = 20\text{ V}$

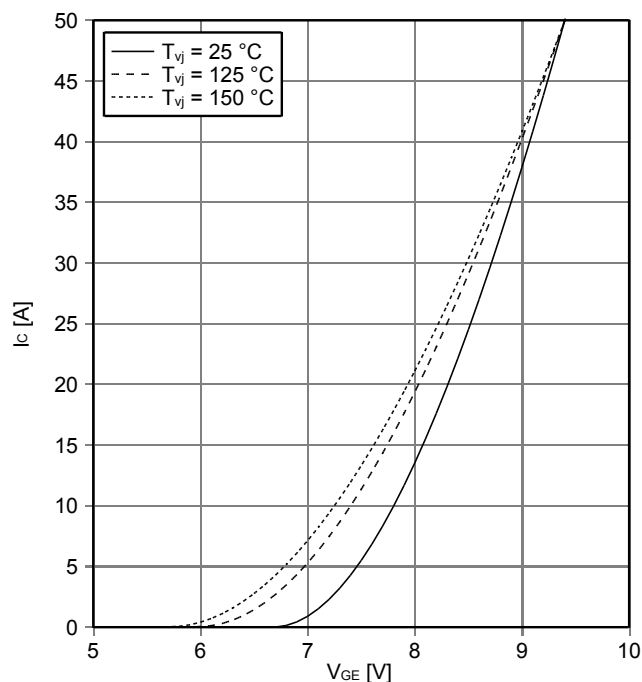

Schaltverluste IGBT, Wechselrichter (typisch)
switching losses IGBT, Inverter (typical)

$E_{on} = f(I_C), E_{off} = f(I_C)$
 $V_{GE} = \pm 15\text{ V}, R_{Gon} = 15\ \Omega, R_{Goff} = 20\ \Omega, V_{CE} = 400\text{ V}$

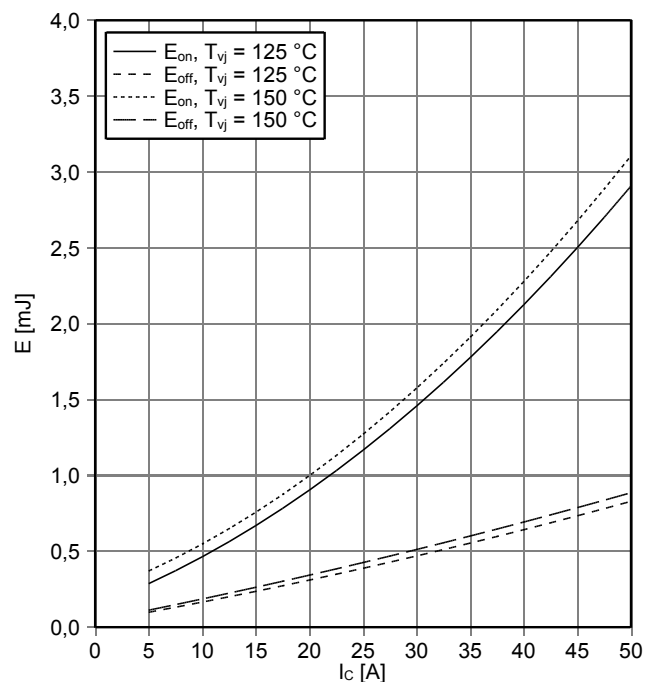

prepared by: MB	date of publication: 2014-10-29
approved by: AKDA	revision: 2.0



**Vorläufige Daten
Preliminary Data**

**Schaltverluste IGBT, Wechselrichter (typisch)
switching losses IGBT, Inverter (typical)**

$E_{on} = f(R_G), E_{off} = f(R_G)$
 $V_{GE} = \pm 15\text{ V}, I_C = 25\text{ A}, V_{CE} = 400\text{ V}$

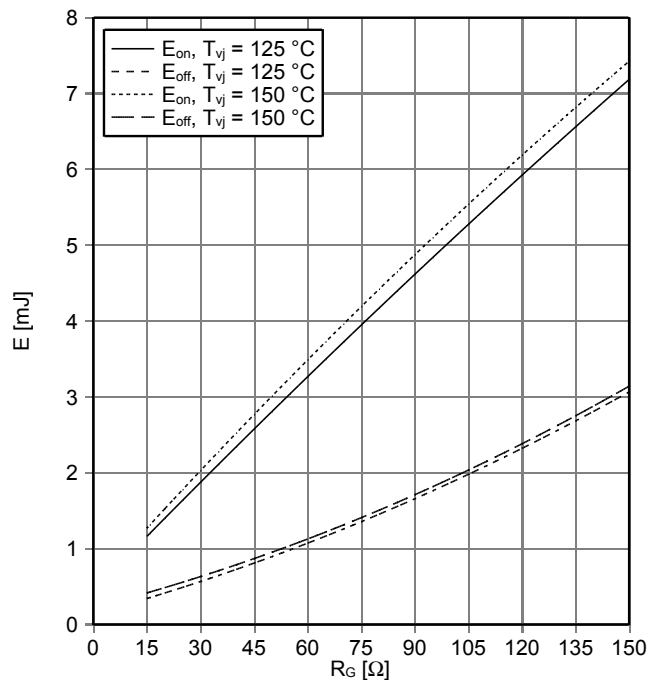

**Transienter Wärmewiderstand IGBT, Wechselrichter
transient thermal impedance IGBT, Inverter**

$Z_{thJH} = f(t)$

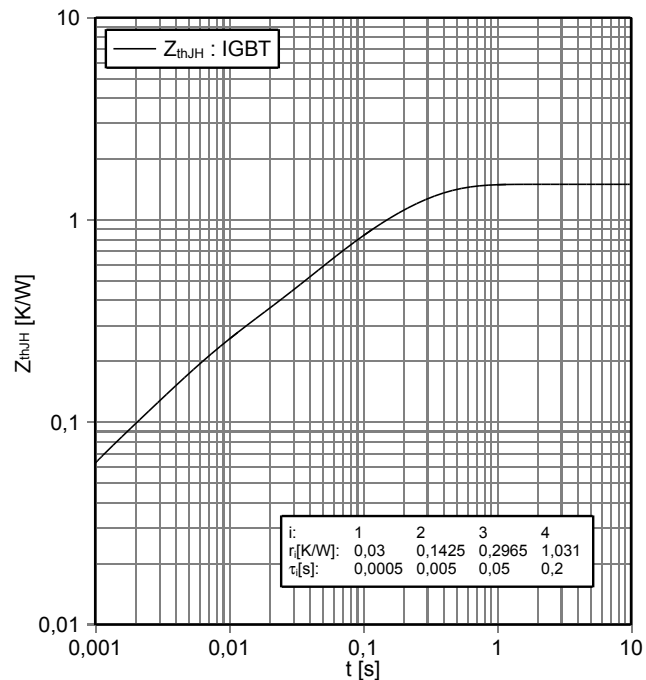

**Sicherer Rückwärts-Arbeitsbereich IGBT, Wechselrichter
(RBSOA)**

reverse bias safe operating area IGBT, Inverter (RBSOA)

$I_C = f(V_{CE})$
 $V_{GE} = \pm 15\text{ V}, R_{Goff} = 20\ \Omega, T_{vj} = 150^\circ\text{C}$

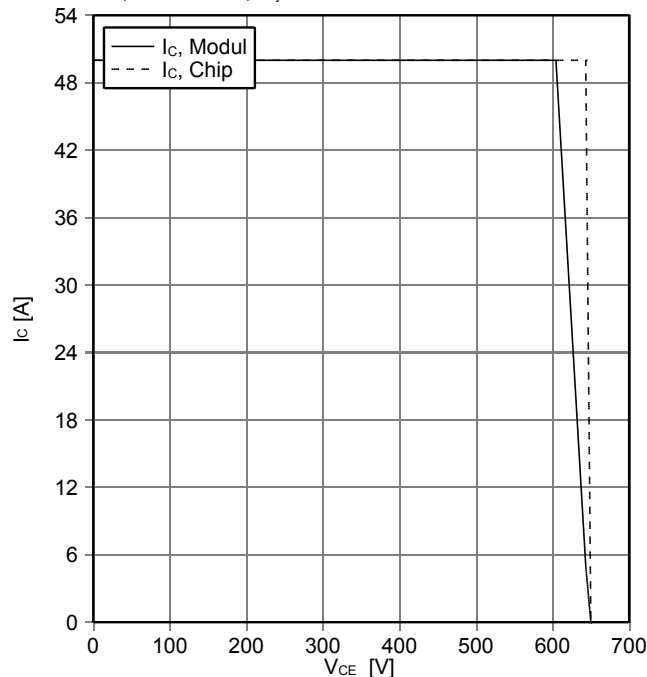

**Durchlasskennlinie der Diode, Wechselrichter (typisch)
forward characteristic of Diode, Inverter (typical)**

$I_F = f(V_F)$

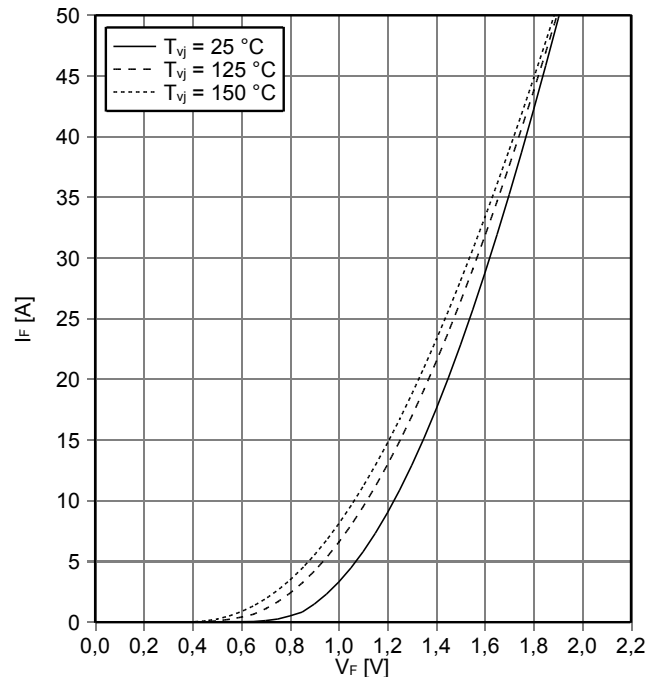

prepared by: MB	date of publication: 2014-10-29
approved by: AKDA	revision: 2.0



Vorläufige Daten
Preliminary Data

Schaltverluste Diode, Wechselrichter (typisch)
switching losses Diode, Inverter (typical)

$E_{rec} = f(I_F)$
 $R_{Gon} = 15 \Omega, V_{CE} = 400 V$

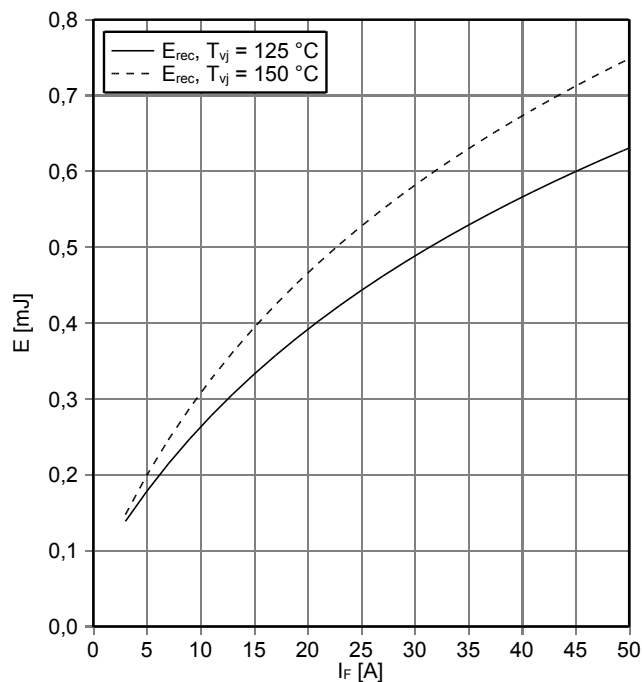

Schaltverluste Diode, Wechselrichter (typisch)
switching losses Diode, Inverter (typical)

$E_{rec} = f(R_G)$
 $I_F = 30 A, V_{CE} = 400 V$

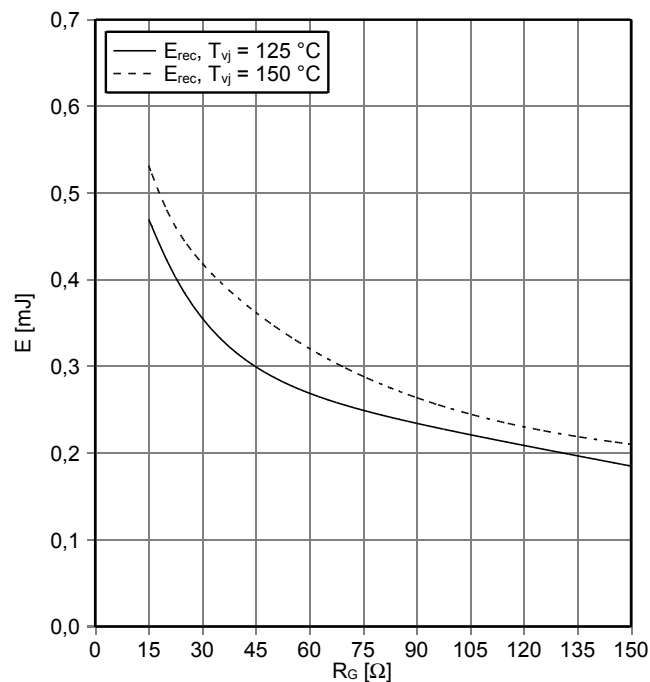

Transienter Wärmewiderstand Diode, Wechselrichter
transient thermal impedance Diode, Inverter

$Z_{thJH} = f(t)$

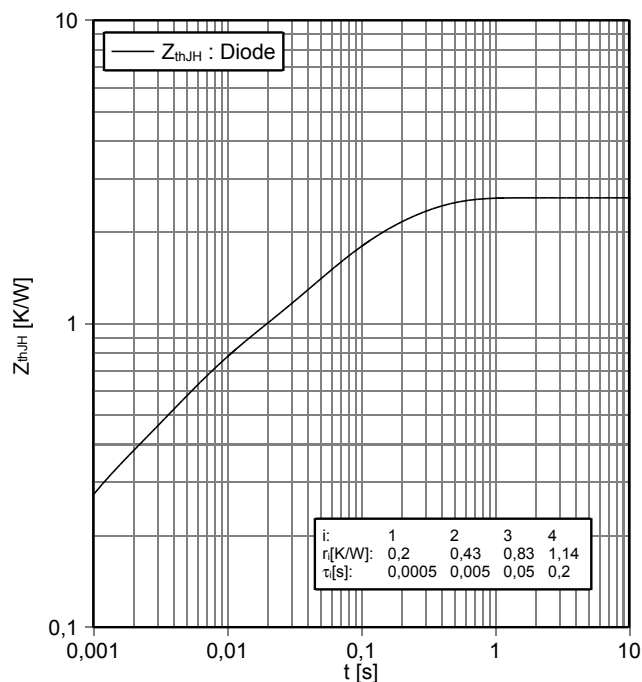

Durchlasskennlinie der Bypass-Diode (typisch)
forward characteristic of Bypass-Diode (typical)

$I_F = f(V_F)$

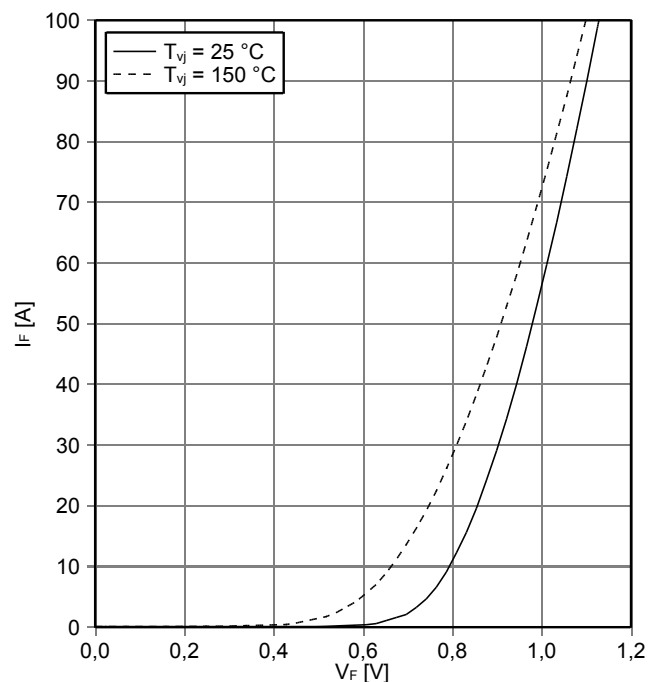

prepared by: MB	date of publication: 2014-10-29
approved by: AKDA	revision: 2.0



**Vorläufige Daten
Preliminary Data**

Durchlasskennlinie der Diode, Hochsetzsteller (typisch)
forward characteristic of Diode, Boost (typical)

$I_F = f(V_F)$

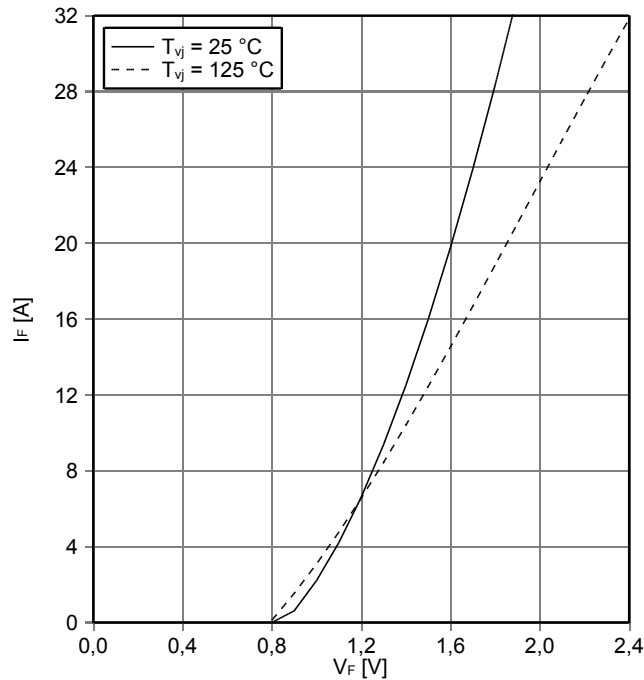

Schaltverluste Diode, Hochsetzsteller (typisch)
switching losses Diode, Boost (typical)

$E_{rec} = f(I_F)$
 $R_{Gon} = 15 \Omega, V_{CE} = 400 V$

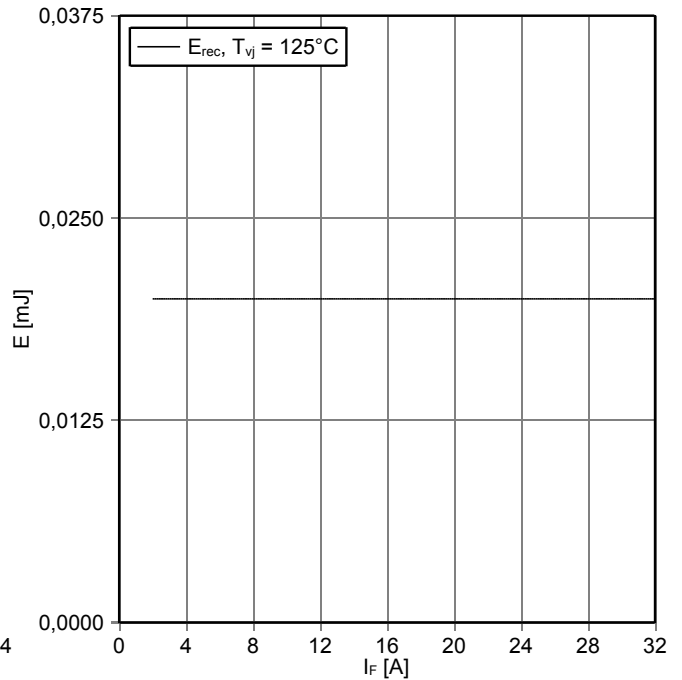

Schaltverluste Diode, Hochsetzsteller (typisch)
switching losses Diode, Boost (typical)

$E_{rec} = f(R_G)$
 $I_F = 16 A, V_{CE} = 400 V$

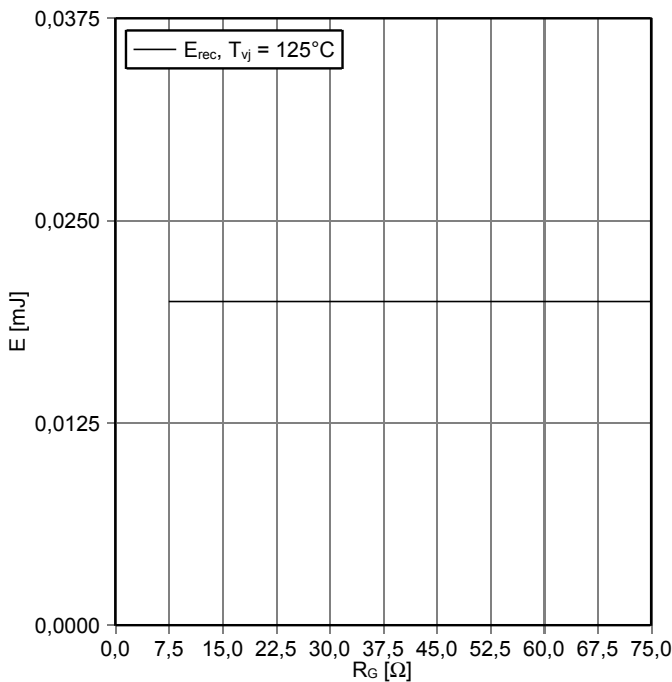

Transienter Wärmewiderstand Diode, Hochsetzsteller
transient thermal impedance Diode, Boost

$Z_{thJH} = f(t)$

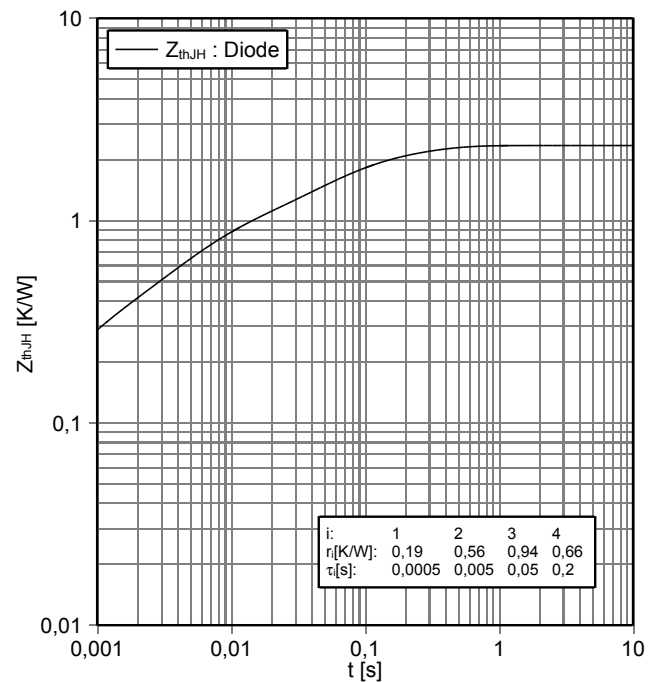

prepared by: MB	date of publication: 2014-10-29
approved by: AKDA	revision: 2.0



Vorläufige Daten
Preliminary Data

Transienter Wärmewiderstand MOSFET
transient thermal impedance MOSFET
 $Z_{thJH} = f(t)$

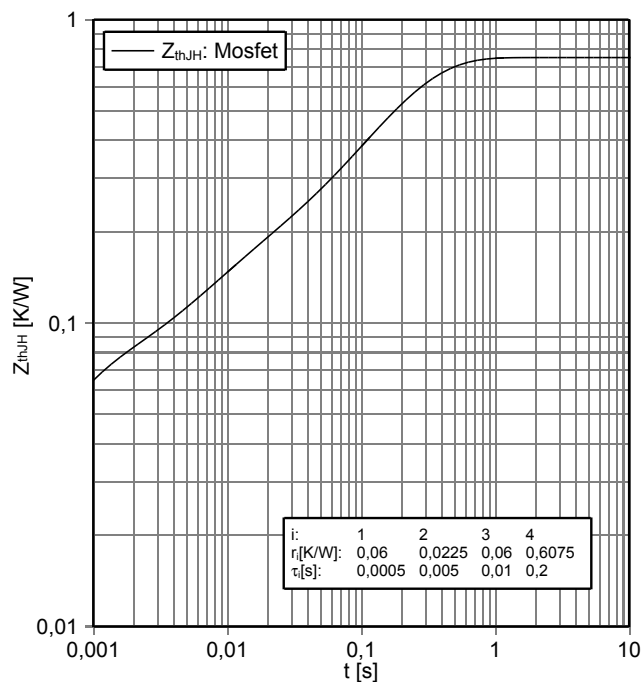

Ausgangskennlinie MOSFET (typisch)
output characteristic MOSFET (typical)
 $I_D = f(V_{DS})$
 $T_{vj} = 150^\circ\text{C}$

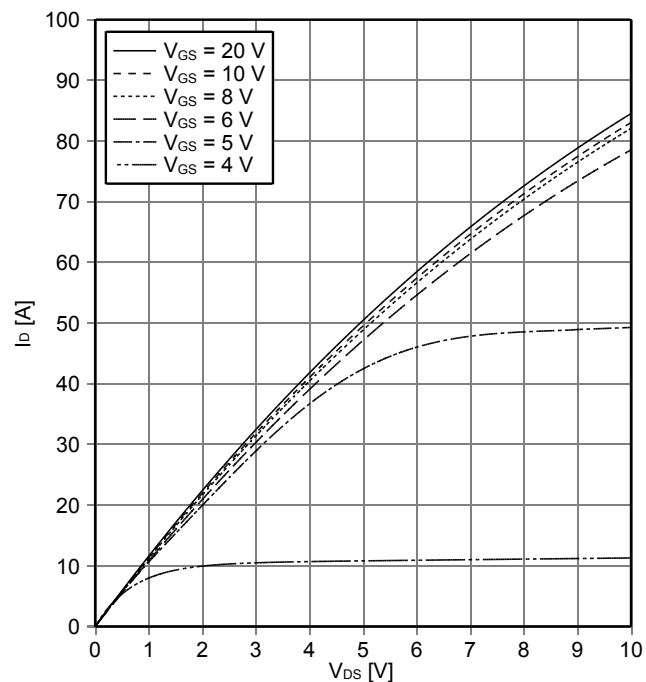

Übertragungscharakteristik MOSFET (typisch)
transfer characteristic MOSFET (typical)
 $I_D = f(V_{GS})$
 $V_{DS} = 10\text{ V}$

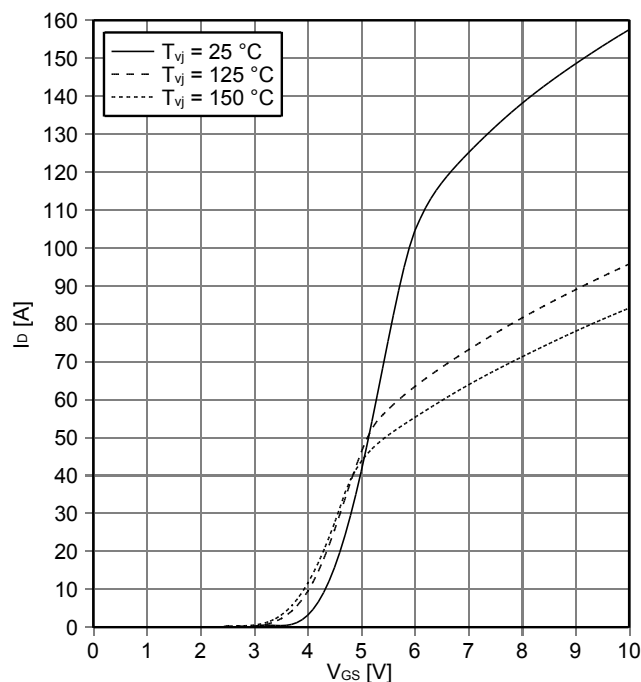

Schaltverluste MOSFET (typisch)
switching losses MOSFET (typical)
 $E_{on} = f(I_c), E_{off} = f(I_c)$
 $V_{GS} = \pm 15\text{ V}, R_{Gon} = 7,5\ \Omega, R_{Goff} = 7,5\ \Omega, V_{DS} = 400\text{ V}$

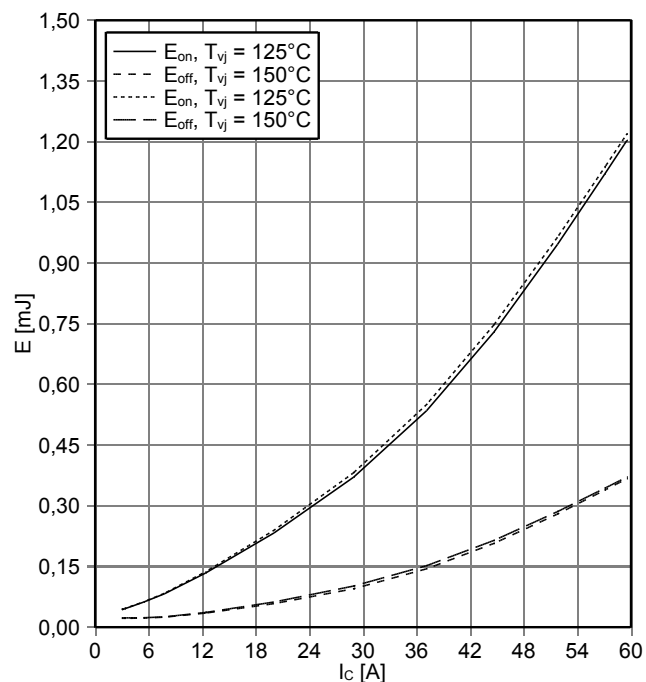

prepared by: MB	date of publication: 2014-10-29
approved by: AKDA	revision: 2.0

Vorläufige Daten
Preliminary Data

Schaltverluste MOSFET (typisch)
switching losses MOSFET (typical)

$E_{on} = f(R_G)$, $E_{off} = f(R_G)$
 $V_{GS} = \pm 15\text{ V}$, $I_D = 25\text{ A}$, $V_{DS} = 400\text{ V}$

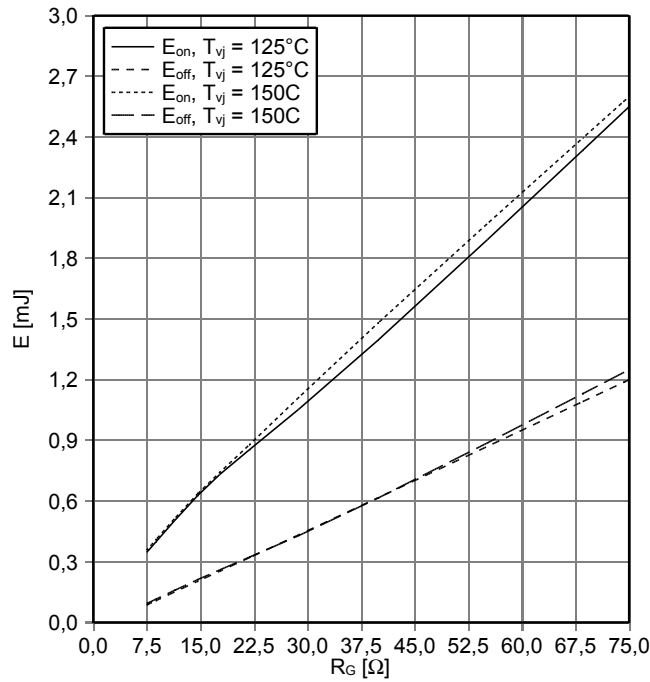

NTC-Widerstand-Temperaturkennlinie (typisch)

NTC-Thermistor-temperature characteristic (typical)
 $R = f(T)$

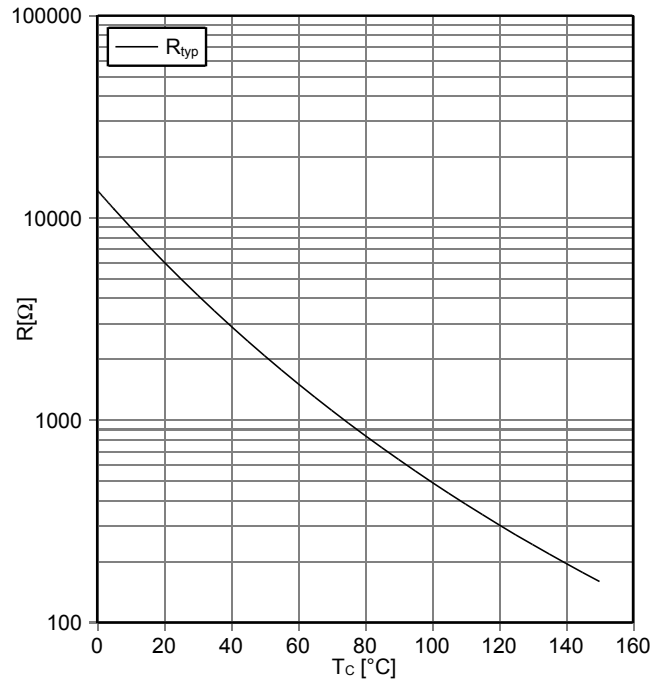

prepared by: MB	date of publication: 2014-10-29
approved by: AKDA	revision: 2.0

Vorläufige Daten
Preliminary Data

Schaltplan / circuit_diagram_headline

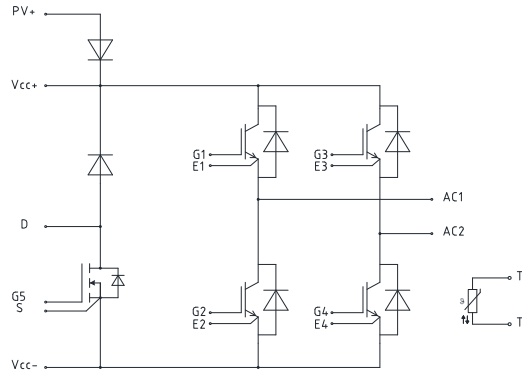

Gehäuseabmessungen / package outlines

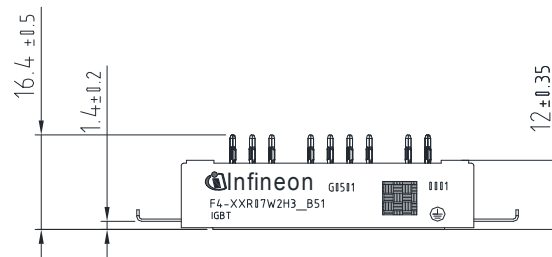
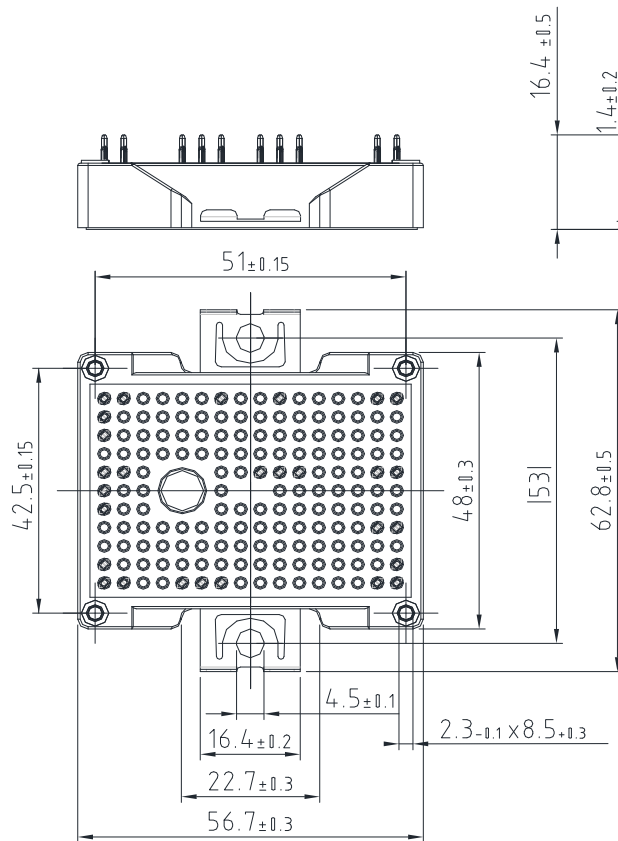

- Pin-Grid 3.2mm
 - Tolerance of PCB hole pattern $\begin{matrix} \oplus \\ \ominus \end{matrix} \phi 0.1$
 - Hole specification for contacts see AN 2009-01:
- Diameters of drill \varnothing 1.15mm
and copper thickness in hole 25-50 μ m

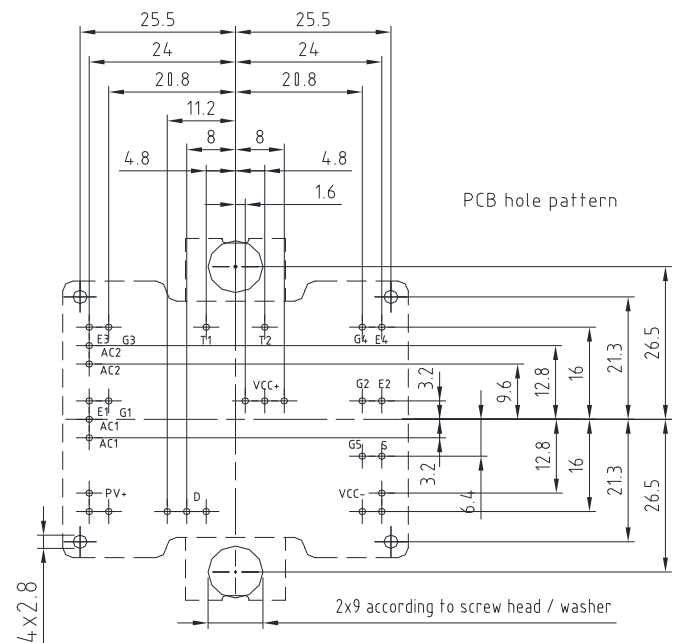

prepared by: MB	date of publication: 2014-10-29
approved by: AKDA	revision: 2.0



**Vorläufige Daten
Preliminary Data**

Nutzungsbedingungen

Die in diesem Produktdatenblatt enthaltenen Daten sind ausschließlich für technisch geschultes Fachpersonal bestimmt. Die Beurteilung der Eignung dieses Produktes für Ihre Anwendung sowie die Beurteilung der Vollständigkeit der bereitgestellten Produktdaten für diese Anwendung obliegt Ihnen bzw. Ihren technischen Abteilungen.

In diesem Produktdatenblatt werden diejenigen Merkmale beschrieben, für die wir eine liefervertragliche Gewährleistung übernehmen. Eine solche Gewährleistung richtet sich ausschließlich nach Maßgabe der im jeweiligen Liefervertrag enthaltenen Bestimmungen. Garantien jeglicher Art werden für das Produkt und dessen Eigenschaften keinesfalls übernommen. Die Angaben in den gültigen Anwendungs- und Montagehinweisen des Moduls sind zu beachten.

Sollten Sie von uns Produktinformationen benötigen, die über den Inhalt dieses Produktdatenblatts hinausgehen und insbesondere eine spezifische Verwendung und den Einsatz dieses Produktes betreffen, setzen Sie sich bitte mit dem für Sie zuständigen Vertriebsbüro in Verbindung (siehe www.infineon.com, Vertrieb&Kontakt). Für Interessenten halten wir Application Notes bereit.

Aufgrund der technischen Anforderungen könnte unser Produkt gesundheitsgefährdende Substanzen enthalten. Bei Rückfragen zu den in diesem Produkt jeweils enthaltenen Substanzen setzen Sie sich bitte ebenfalls mit dem für Sie zuständigen Vertriebsbüro in Verbindung.

Sollten Sie beabsichtigen, das Produkt in Anwendungen der Luftfahrt, in gesundheits- oder lebensgefährdenden oder lebenserhaltenden Anwendungsbereichen einzusetzen, bitten wir um Mitteilung. Wir weisen darauf hin, dass wir für diese Fälle

- die gemeinsame Durchführung eines Risiko- und Qualitätsassessments;
- den Abschluss von speziellen Qualitätssicherungsvereinbarungen;
- die gemeinsame Einführung von Maßnahmen zu einer laufenden Produktbeobachtung dringend empfehlen und gegebenenfalls die Belieferung von der Umsetzung solcher Maßnahmen abhängig machen.

Soweit erforderlich, bitten wir Sie, entsprechende Hinweise an Ihre Kunden zu geben.

Inhaltliche Änderungen dieses Produktdatenblatts bleiben vorbehalten.

Terms & Conditions of usage

The data contained in this product data sheet is exclusively intended for technically trained staff. You and your technical departments will have to evaluate the suitability of the product for the intended application and the completeness of the product data with respect to such application.

This product data sheet is describing the characteristics of this product for which a warranty is granted. Any such warranty is granted exclusively pursuant the terms and conditions of the supply agreement. There will be no guarantee of any kind for the product and its characteristics. The information in the valid application- and assembly notes of the module must be considered.

Should you require product information in excess of the data given in this product data sheet or which concerns the specific application of our product, please contact the sales office, which is responsible for you (see www.infineon.com). For those that are specifically interested we may provide application notes.

Due to technical requirements our product may contain dangerous substances. For information on the types in question please contact the sales office, which is responsible for you.

Should you intend to use the Product in aviation applications, in health or live endangering or life support applications, please notify. Please note, that for any such applications we urgently recommend

- to perform joint Risk and Quality Assessments;
- the conclusion of Quality Agreements;
- to establish joint measures of an ongoing product survey, and that we may make delivery depended on the realization of any such measures.

If and to the extent necessary, please forward equivalent notices to your customers.

Changes of this product data sheet are reserved.

prepared by: MB	date of publication: 2014-10-29
approved by: AKDA	revision: 2.0

Mouser Electronics

Authorized Distributor

Click to View Pricing, Inventory, Delivery & Lifecycle Information:

[Infineon:](#)

[F4-50R07W2H3_B51](#)