

IGBT

TRENCHSTOP™ Performance technology copacked with RAPID 1
fast anti-parallel diode

IKW50N60DTP

600V DuoPack IGBT and diode
TRENCHSTOP™ Performance series

Data sheet

High speed IGBT in Trench and Fieldstop technology

Features:

TRENCHSTOP™ technology offering

- very low V_{CEsat}
- low turn-off losses
- short tail current
- low EMI
- Very soft, fast recovery anti-parallel diode
- maximum junction temperature 175°C
- qualified according to JEDEC for target applications
- Pb-free lead plating; RoHS compliant
- complete product spectrum and PSpice Models:
<http://www.infineon.com/igbt/>

Applications:

- drives
- solar inverters
- uninterruptible power supplies
- converters with medium switching frequency

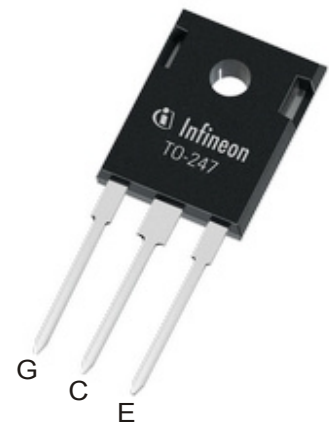
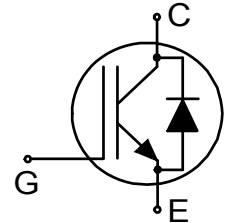

Key Performance and Package Parameters

Type	V_{CE}	I_C	$V_{CEsat}, T_{vj}=25^{\circ}C$	T_{vjmax}	Marking	Package
IKW50N60DTP	600V	50A	1.6V	175°C	K50DDTP	PG-TO247-3



Table of Contents

Description 2

Table of Contents 3

Maximum Ratings 4

Thermal Resistance 4

Electrical Characteristics 5

Electrical Characteristics Diagrams 7

Package Drawing14

Testing Conditions15

Revision History16

Disclaimer16

Maximum Ratings

For optimum lifetime and reliability, Infineon recommends operating conditions that do not exceed 80% of the maximum ratings stated in this datasheet.

Parameter	Symbol	Value	Unit
Collector-emitter voltage, $T_{vj} \geq 25^{\circ}\text{C}$	V_{CE}	600	V
DC collector current, limited by T_{vjmax} $T_C = 25^{\circ}\text{C}$ value limited by bondwire $T_C = 100^{\circ}\text{C}$	I_C	80.0 61.0	A
Pulsed collector current, t_p limited by $T_{vjmax}^{1)}$	I_{Cpuls}	150.0	A
Turn off safe operating area $V_{CE} \leq 600\text{V}$, $T_{vj} \leq 175^{\circ}\text{C}$, $t_p = 1\mu\text{s}^{1)}$	-	150.0	A
Diode forward current, limited by T_{vjmax} $T_C = 25^{\circ}\text{C}$ $T_C = 100^{\circ}\text{C}$	I_F	62.0 39.0	A
Diode pulsed current, t_p limited by $T_{vjmax}^{1)}$	I_{Fpuls}	150.0	A
Gate-emitter voltage	V_{GE}	± 20	V
Short circuit withstand time $V_{GE} = 15.0\text{V}$, $V_{CC} \leq 400\text{V}$ Allowed number of short circuits < 1000 Time between short circuits: $\geq 1.0\text{s}$ $T_{vj} = 150^{\circ}\text{C}$	t_{SC}	5	μs
Power dissipation $T_C = 25^{\circ}\text{C}$ Power dissipation $T_C = 100^{\circ}\text{C}$	P_{tot}	319.2 159.6	W
Operating junction temperature	T_{vj}	-40...+175	$^{\circ}\text{C}$
Storage temperature	T_{stg}	-55...+150	$^{\circ}\text{C}$
Soldering temperature, wave soldering 1.6mm (0.063in.) from case for 10s		260	$^{\circ}\text{C}$
Mounting torque, M3 screw Maximum of mounting processes: 3	M	0.6	Nm

Thermal Resistance

Parameter	Symbol	Conditions	Value			Unit
			min.	typ.	max.	

R_{th} Characteristics

IGBT thermal resistance, junction - case	$R_{th(j-c)}$		-	0.36	0.47	K/W
Diode thermal resistance, junction - case	$R_{th(j-c)}$		-	0.62	0.95	K/W

¹⁾ Defined by design. Not subject to production test.

Electrical Characteristic, at $T_{vj} = 25^{\circ}\text{C}$, unless otherwise specified

Parameter	Symbol	Conditions	Value			Unit
			min.	typ.	max.	
Static Characteristic						
Collector-emitter breakdown voltage	$V_{(BR)CES}$	$V_{GE} = 0\text{V}, I_C = 0.20\text{mA}$	600	-	-	V
Collector-emitter saturation voltage	V_{CESat}	$V_{GE} = 15.0\text{V}, I_C = 50.0\text{A}$ $T_{vj} = 25^{\circ}\text{C}$ $T_{vj} = 175^{\circ}\text{C}$	- -	1.60 1.94	1.80 -	V
Diode forward voltage	V_F	$V_{GE} = 0\text{V}, I_F = 30.0\text{A}$ $T_{vj} = 25^{\circ}\text{C}$ $T_{vj} = 175^{\circ}\text{C}$	- -	1.45 1.39	1.70 -	V
Gate-emitter threshold voltage	$V_{GE(th)}$	$I_C = 0.80\text{mA}, V_{CE} = V_{GE}$	4.1	5.1	5.7	V
Zero gate voltage collector current	I_{CES}	$V_{CE} = 600\text{V}, V_{GE} = 0\text{V}$ $T_{vj} = 25^{\circ}\text{C}$ $T_{vj} = 175^{\circ}\text{C}$	- -	- -	40 -	μA
Gate-emitter leakage current	I_{GES}	$V_{CE} = 0\text{V}, V_{GE} = 20\text{V}$	-	-	100	nA
Transconductance	g_{fs}	$V_{CE} = 20\text{V}, I_C = 50.0\text{A}$	-	78.0	-	S

Electrical Characteristic, at $T_{vj} = 25^{\circ}\text{C}$, unless otherwise specified

Parameter	Symbol	Conditions	Value			Unit
			min.	typ.	max.	
Dynamic Characteristic						
Input capacitance	C_{ies}	$V_{CE} = 25\text{V}, V_{GE} = 0\text{V}, f = 1\text{MHz}$	-	1950	-	pF
Output capacitance	C_{oes}		-	109	-	
Reverse transfer capacitance	C_{res}		-	67	-	
Gate charge	Q_G	$V_{CC} = 480\text{V}, I_C = 50.0\text{A},$ $V_{GE} = 15\text{V}$	-	249.0	-	nC
Internal emitter inductance measured 5mm (0.197 in.) from case	L_E		-	13.0	-	nH
Short circuit collector current Max. 1000 short circuits Time between short circuits: $\geq 1.0\text{s}$	$I_{C(SC)}$	$V_{GE} = 15.0\text{V}, V_{CC} \leq 400\text{V},$ $t_{SC} \leq 5\mu\text{s}$ $T_{vj} = 150^{\circ}\text{C}$	-	255	-	A

Switching Characteristic, Inductive Load

Parameter	Symbol	Conditions	Value			Unit
			min.	typ.	max.	

IGBT Characteristic, at $T_{vj} = 25^{\circ}\text{C}$

Turn-on delay time	$t_{d(on)}$	$T_{vj} = 25^{\circ}\text{C},$ $V_{CC} = 400\text{V}, I_C = 50.0\text{A},$ $V_{GE} = 0.0/15.0\text{V},$ $R_{G(on)} = 7.0\Omega, R_{G(off)} = 7.0\Omega,$ $L_{\sigma} = 32\text{nH}, C_{\sigma} = 60\text{pF}$ L_{σ}, C_{σ} from Fig. E Energy losses include "tail" and diode reverse recovery.	-	20	-	ns
Rise time	t_r		-	30	-	ns
Turn-off delay time	$t_{d(off)}$		-	215	-	ns
Fall time	t_f		-	18	-	ns
Turn-on energy	E_{on}		-	1.53	-	mJ
Turn-off energy	E_{off}		-	0.85	-	mJ
Total switching energy	E_{ts}	-	2.38	-	mJ	

Diode reverse recovery time	t_{rr}	$T_{vj} = 25^{\circ}\text{C}$, $V_R = 400\text{V}$, $I_F = 30.0\text{A}$, $di_F/dt = 870\text{A}/\mu\text{s}$	-	115	-	ns
Diode reverse recovery charge	Q_{rr}		-	0.75	-	μC
Diode peak reverse recovery current	I_{rrm}		-	11.3	-	A
Diode peak rate of fall of reverse recovery current during t_b	di_{rr}/dt		-	125	-	$\text{A}/\mu\text{s}$

Switching Characteristic, Inductive Load

Parameter	Symbol	Conditions	Value			Unit
			min.	typ.	max.	

IGBT Characteristic, at $T_{vj} = 175^{\circ}\text{C}$

Turn-on delay time	$t_{d(on)}$	$T_{vj} = 175^{\circ}\text{C}$, $V_{CC} = 400\text{V}$, $I_C = 50.0\text{A}$, $V_{GE} = 0.0/15.0\text{V}$, $R_{G(on)} = 7.0\Omega$, $R_{G(off)} = 7.0\Omega$, $L\sigma = 32\text{nH}$, $C\sigma = 60\text{pF}$ $L\sigma$, $C\sigma$ from Fig. E Energy losses include "tail" and diode reverse recovery.	-	21	-	ns
Rise time	t_r		-	34	-	ns
Turn-off delay time	$t_{d(off)}$		-	277	-	ns
Fall time	t_f		-	55	-	ns
Turn-on energy	E_{on}		-	2.25	-	mJ
Turn-off energy	E_{off}		-	1.39	-	mJ
Total switching energy	E_{ts}		-	3.64	-	mJ

Diode reverse recovery time	t_{rr}	$T_{vj} = 175^{\circ}\text{C}$, $V_R = 400\text{V}$, $I_F = 30.0\text{A}$, $di_F/dt = 870\text{A}/\mu\text{s}$	-	194	-	ns
Diode reverse recovery charge	Q_{rr}		-	2.15	-	μC
Diode peak reverse recovery current	I_{rrm}		-	18.8	-	A
Diode peak rate of fall of reverse recovery current during t_b	di_{rr}/dt		-	120	-	$\text{A}/\mu\text{s}$

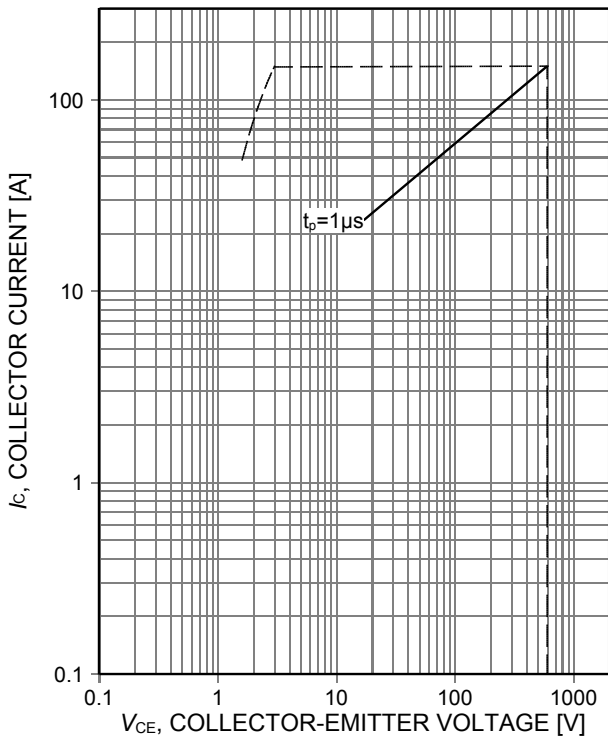

Figure 1. **Forward bias safe operating area**
($D=0$, $T_C=25^\circ\text{C}$, $T_J \leq 175^\circ\text{C}$; $V_{GE}=15\text{V}$)

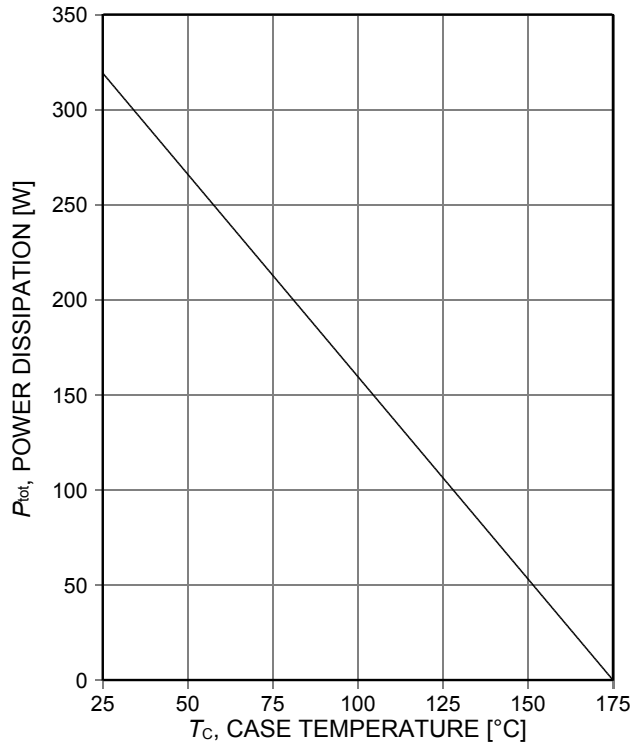

Figure 2. **Power dissipation as a function of case temperature**
($T_J \leq 175^\circ\text{C}$)

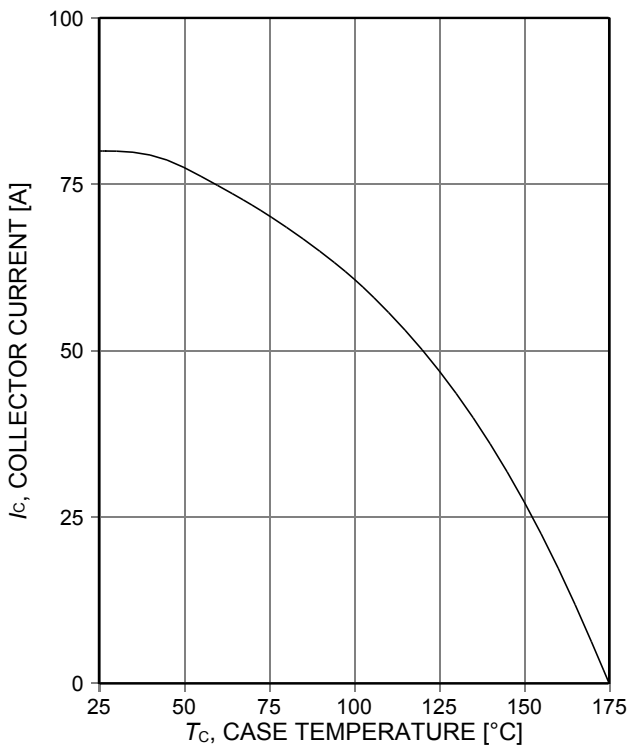

Figure 3. **Collector current as a function of case temperature**
($V_{GE} \geq 15\text{V}$, $T_J \leq 175^\circ\text{C}$)

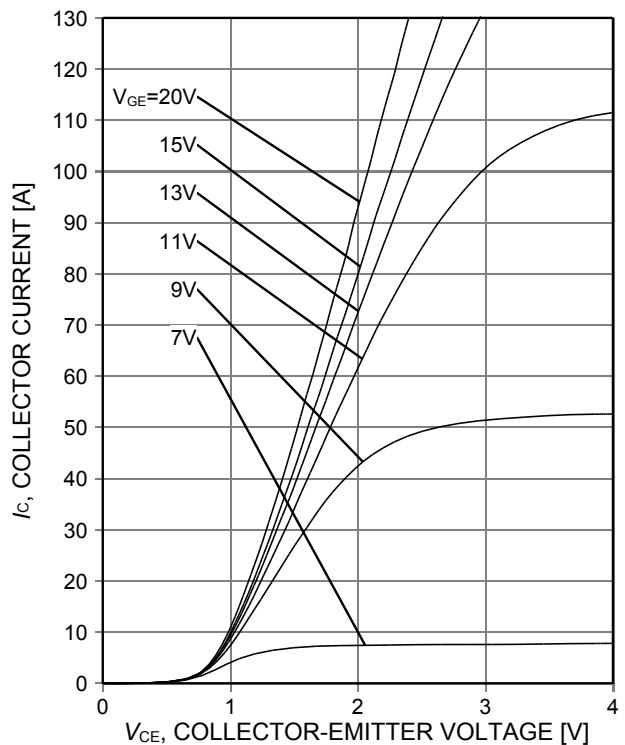

Figure 4. **Typical output characteristic**
($T_J=25^\circ\text{C}$)

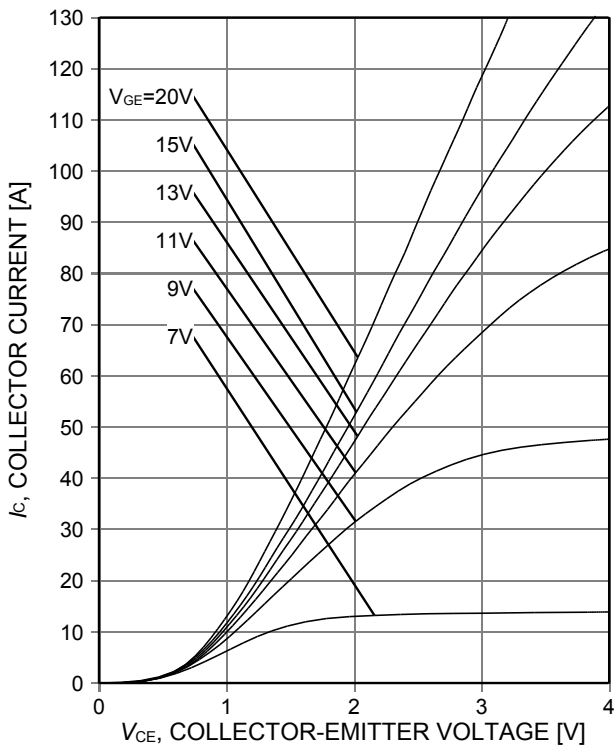

Figure 5. **Typical output characteristic**
($T_j=175^\circ\text{C}$)

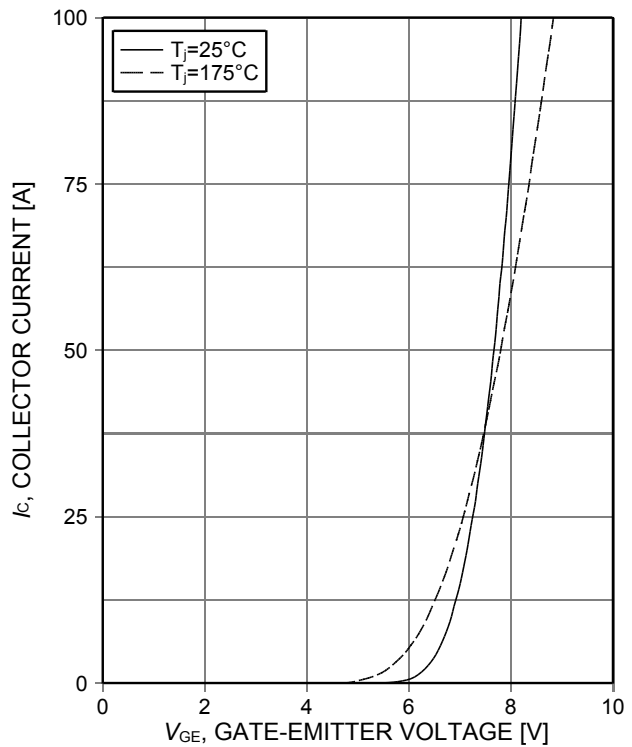

Figure 6. **Typical transfer characteristic**
($V_{CE}=20\text{V}$)

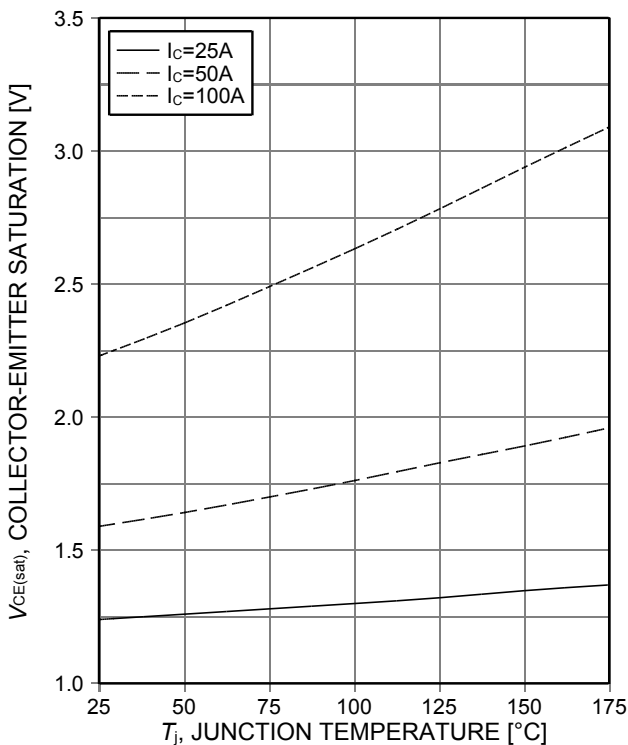

Figure 7. **Typical collector-emitter saturation voltage as a function of junction temperature**
($V_{GE}=15\text{V}$)

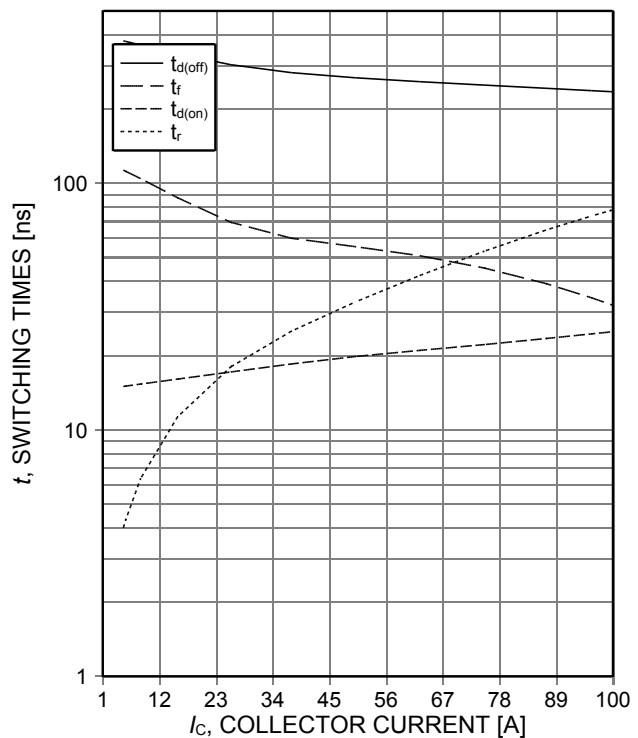

Figure 8. **Typical switching times as a function of collector current**
(ind. load, $T_j=175^\circ\text{C}$, $V_{CE}=400\text{V}$, $V_{GE}=15/0\text{V}$, $r_G=7\Omega$, test circuit in Fig. E)

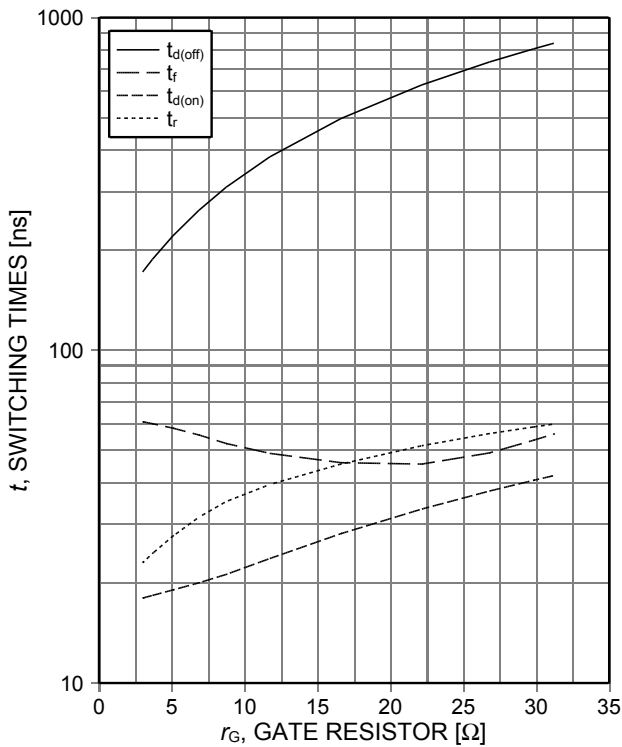

Figure 9. **Typical switching times as a function of gate resistor**
(ind. load, $T_j=175^\circ\text{C}$, $V_{CE}=400\text{V}$, $V_{GE}=15/0\text{V}$, $I_C=50\text{A}$, test circuit in Fig. E)

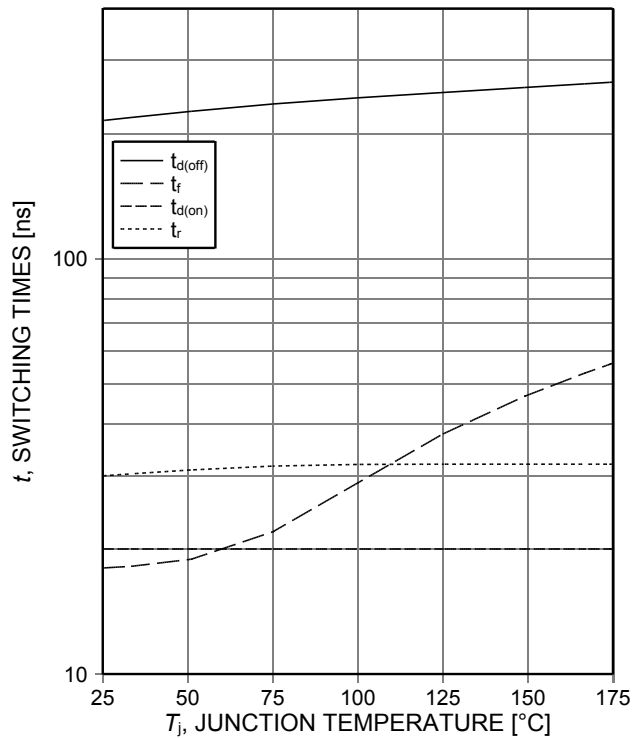

Figure 10. **Typical switching times as a function of junction temperature**
(ind. load, $V_{CE}=400\text{V}$, $V_{GE}=15/0\text{V}$, $I_C=50\text{A}$, $r_G=7\Omega$, test circuit in Fig. E)

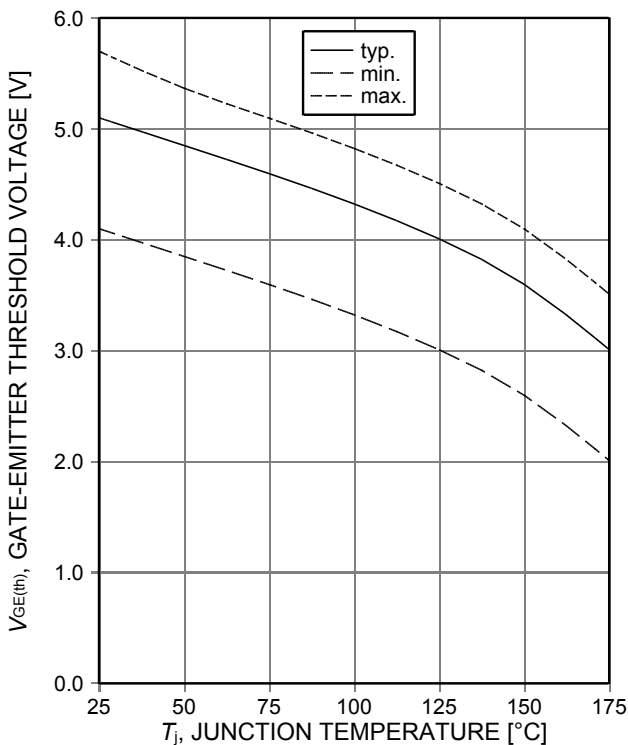

Figure 11. **Gate-emitter threshold voltage as a function of junction temperature**
($I_C=0,8\text{mA}$)

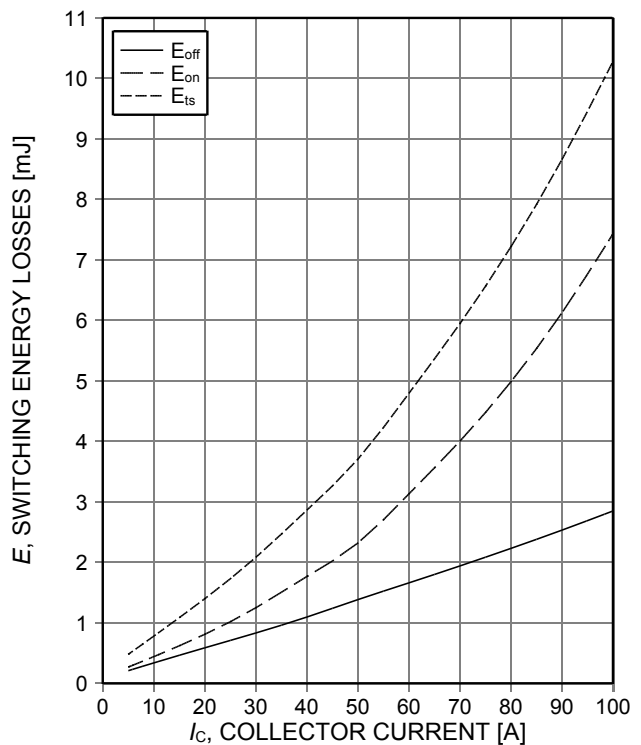

Figure 12. **Typical switching energy losses as a function of collector current**
(ind. load, $T_j=175^\circ\text{C}$, $V_{CE}=400\text{V}$, $V_{GE}=15/0\text{V}$, $r_G=7\Omega$, test circuit in Fig. E)

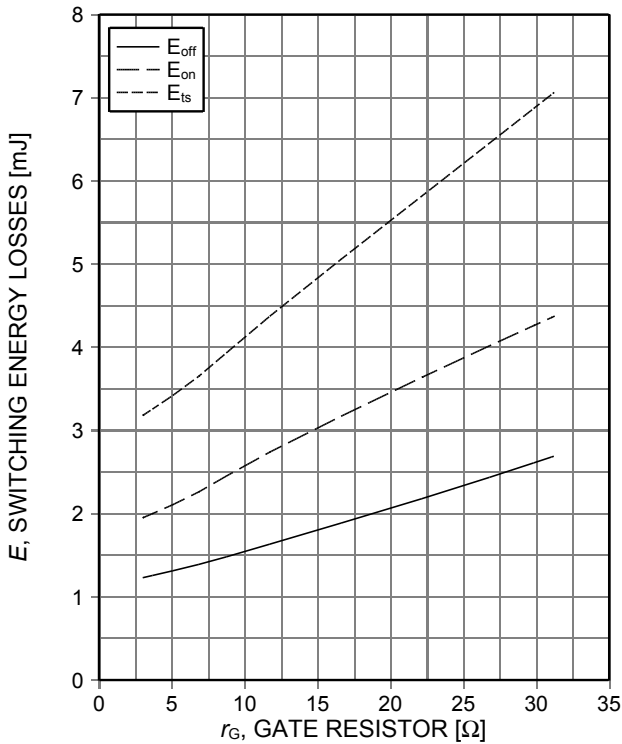

Figure 13. **Typical switching energy losses as a function of gate resistor**
 (ind. load, $T_j=175^\circ\text{C}$, $V_{CE}=400\text{V}$, $V_{GE}=15/0\text{V}$, $I_c=50\text{A}$, test circuit in Fig. E)

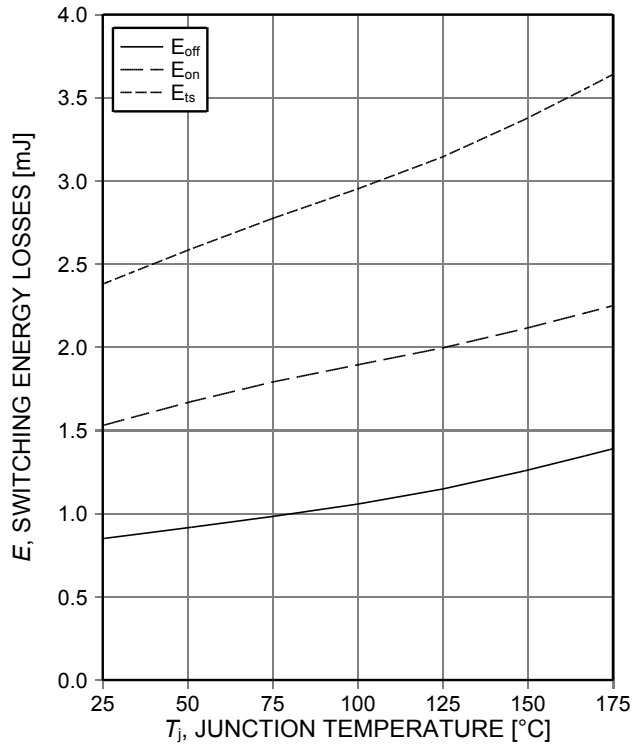

Figure 14. **Typical switching energy losses as a function of junction temperature**
 (ind load, $V_{CE}=400\text{V}$, $V_{GE}=15/0\text{V}$, $I_c=50\text{A}$, $r_G=7\Omega$, test circuit in Fig. E)

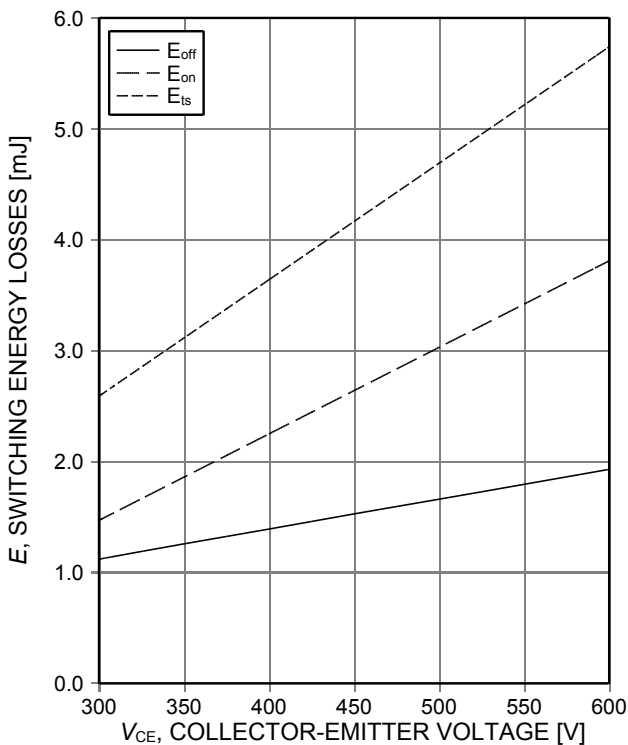

Figure 15. **Typical switching energy losses as a function of collector emitter voltage**
 (ind. load, $T_j=175^\circ\text{C}$, $V_{GE}=15/0\text{V}$, $I_c=50\text{A}$, $r_G=7\Omega$, test circuit in Fig. E)

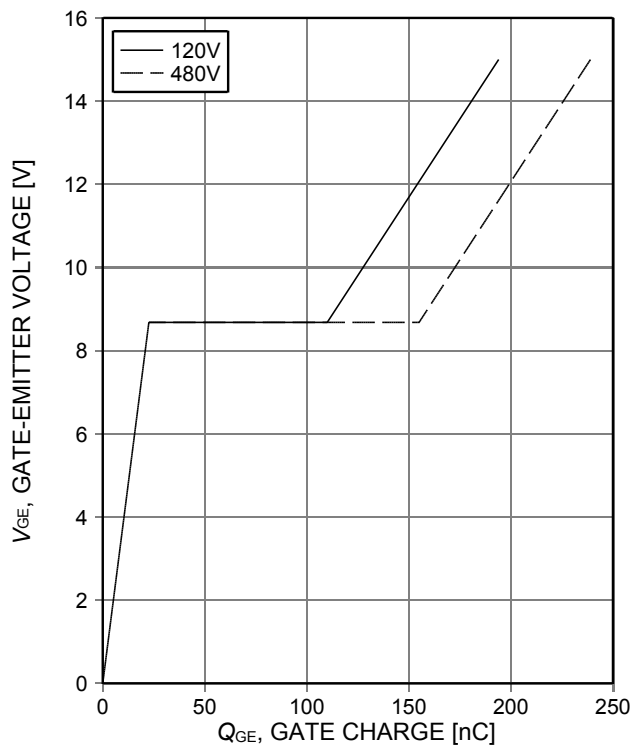

Figure 16. **Typical gate charge**
 ($I_c=50\text{A}$)

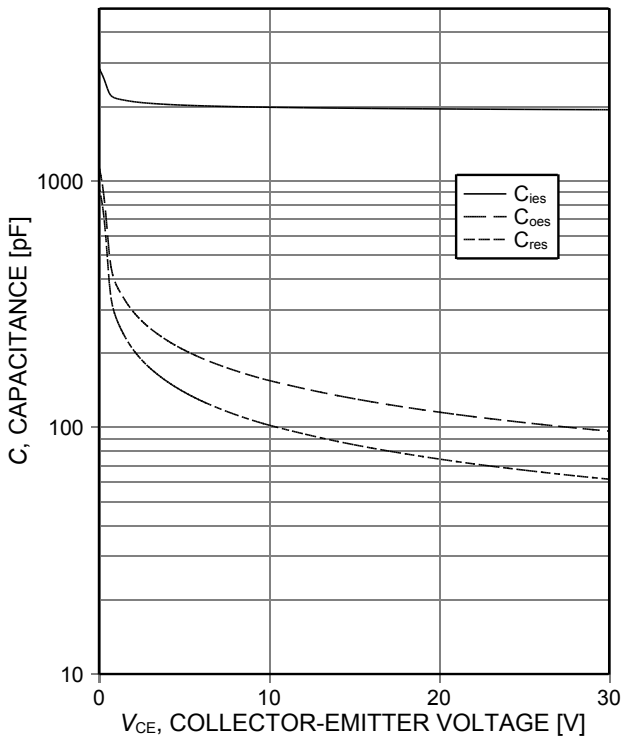

Figure 17. Typical capacitance as a function of collector-emitter voltage ($V_{GE}=0V$, $f=1MHz$)

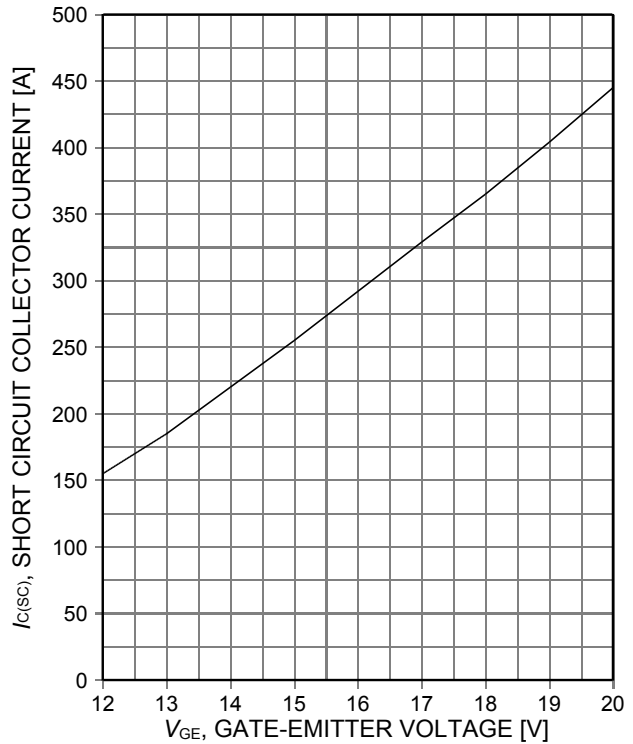

Figure 18. Typical short circuit collector current as a function of gate-emitter voltage ($V_{CE}\leq 400V$, start at $T_J=150^\circ C$)



Figure 19. Short circuit withstand time as a function of gate-emitter voltage ($V_{CE}\leq 400V$, start at $T_J\leq 150^\circ C$)

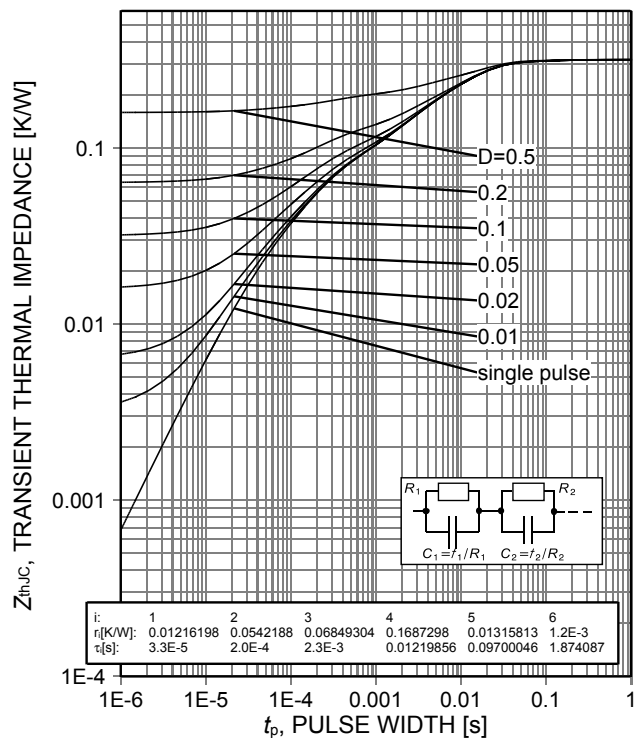

Figure 20. Typical IGBT transient thermal impedance ($D=t_p/T$)

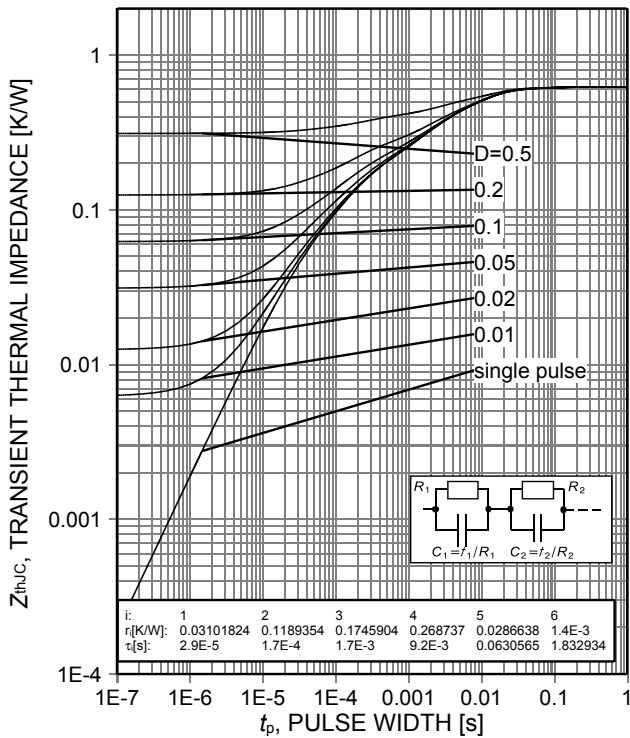

Figure 21. Typical diode transient thermal impedance as a function of pulse width ($D=t_p/T$)

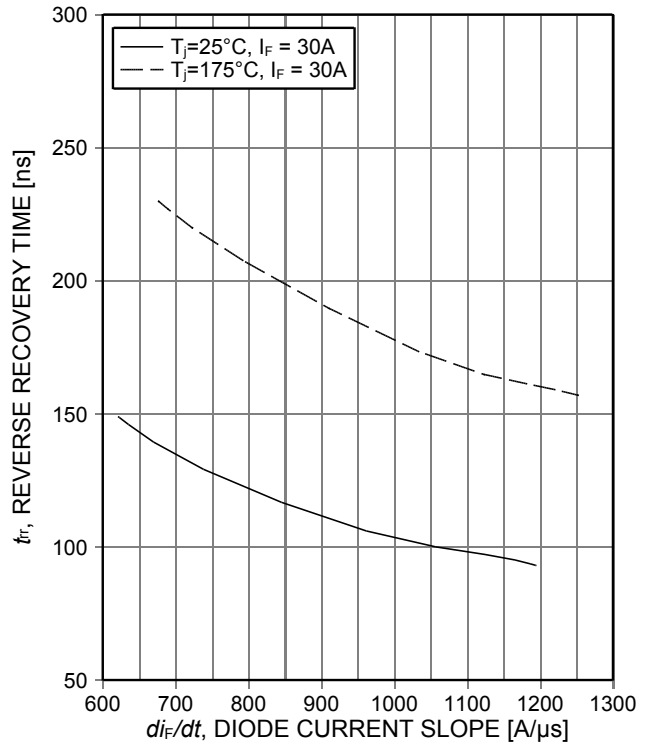

Figure 22. Typical reverse recovery time as a function of diode current slope ($V_R=400V$)

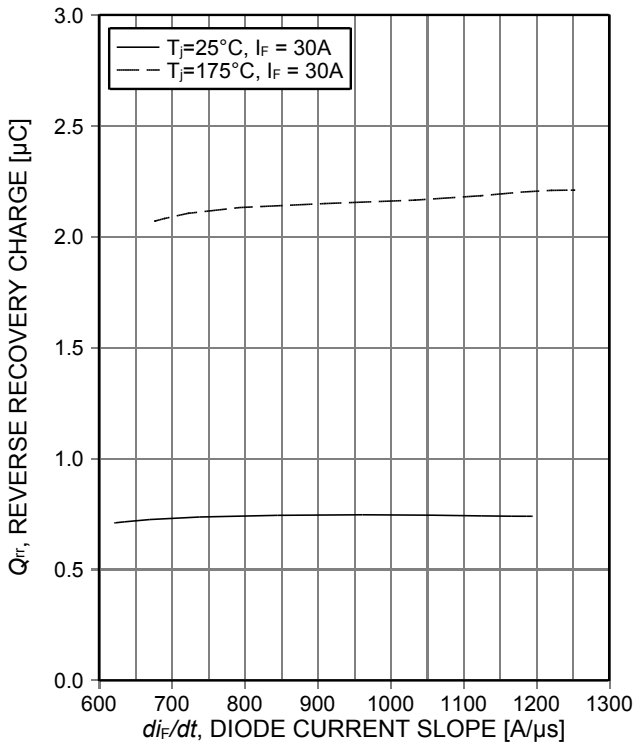

Figure 23. Typical reverse recovery charge as a function of diode current slope ($V_R=400V$)

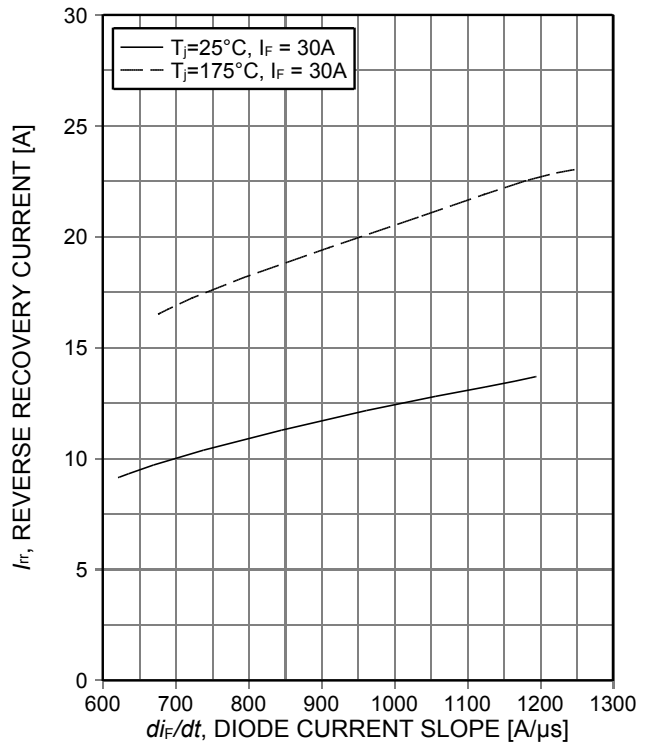

Figure 24. Typical reverse recovery current as a function of diode current slope ($V_R=400V$)

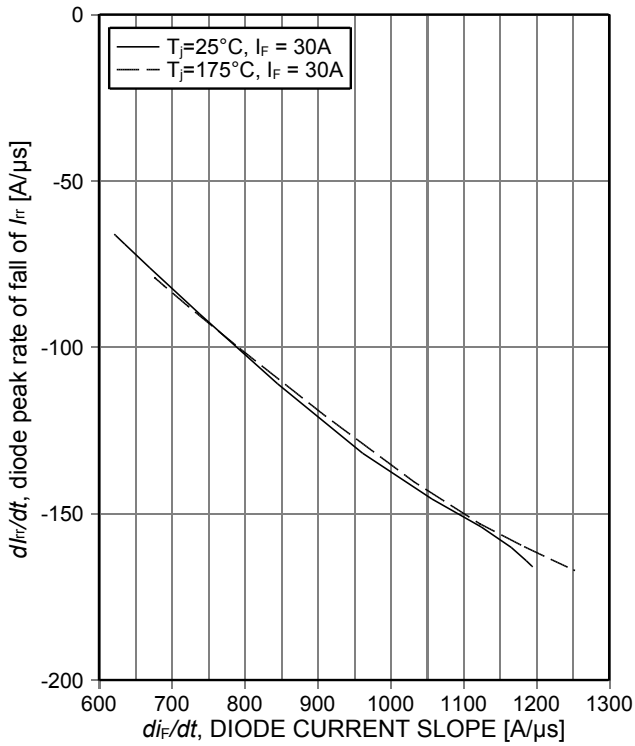

Figure 25. Typical diode peak rate of fall of reverse recovery current as a function of diode current slope ($V_R=400V$)

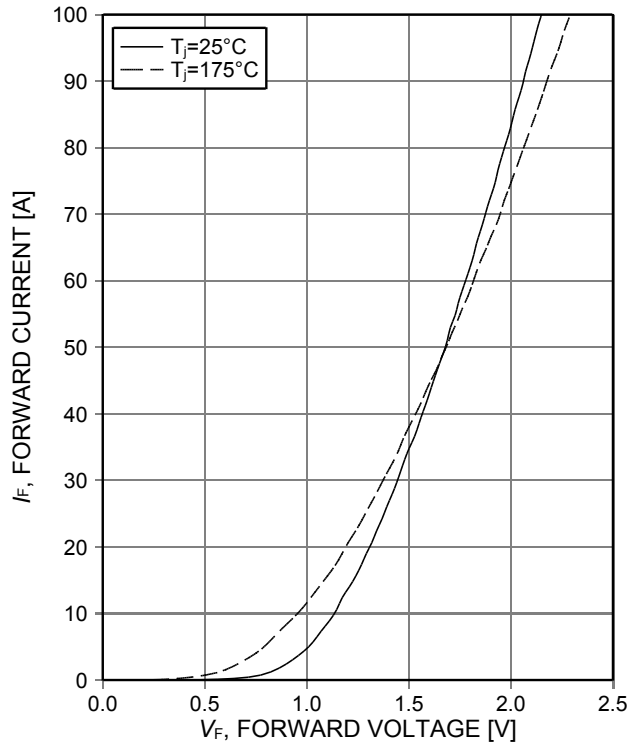

Figure 26. Typical diode forward current as a function of forward voltage

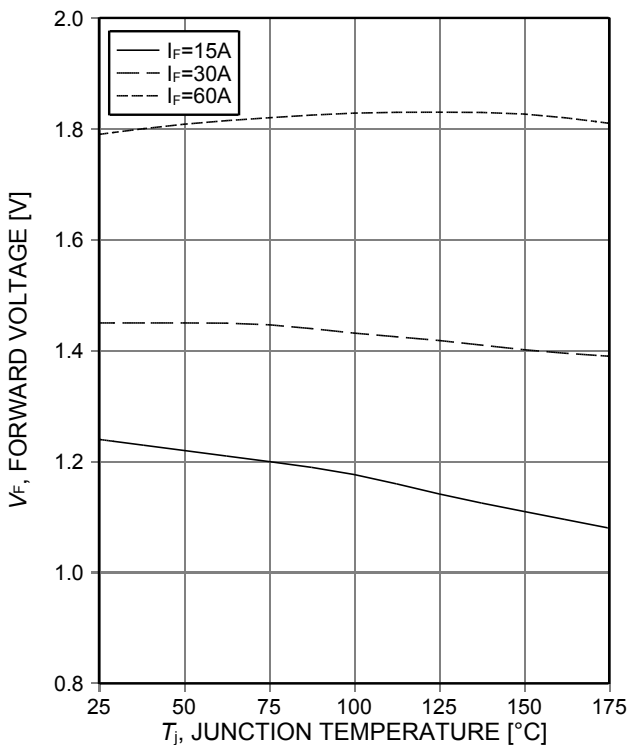

Figure 27. Typical diode forward voltage as a function of junction temperature

Package Drawing PG-TO247-3



DIM	MILLIMETERS		INCHES	
	MIN	MAX	MIN	MAX
A	4.83	5.21	0.190	0.205
A1	2.27	2.54	0.089	0.100
A2	1.85	2.16	0.073	0.085
b	1.07	1.33	0.042	0.052
b1	1.90	2.41	0.075	0.095
b2	1.90	2.16	0.075	0.085
b3	2.87	3.38	0.113	0.133
b4	2.87	3.13	0.113	0.123
c	0.55	0.68	0.022	0.027
D	20.80	21.10	0.819	0.831
D1	16.25	17.65	0.640	0.695
D2	0.95	1.35	0.037	0.053
E	15.70	16.13	0.618	0.635
E1	13.10	14.15	0.516	0.557
E2	3.68	5.10	0.145	0.201
E3	1.00	2.60	0.039	0.102
e	5.44 (BSC)		0.214 (BSC)	
N	3		3	
L	19.80	20.32	0.780	0.800
L1	4.10	4.47	0.161	0.176
ϕP	3.50	3.70	0.138	0.146
Q	5.49	6.00	0.216	0.236
S	6.04	6.30	0.238	0.248

DOCUMENT NO.
Z8B00003327

SCALE

EUROPEAN PROJECTION

ISSUE DATE
09-07-2010

REVISION
05

Testing Conditions



Figure A. Definition of switching times



Figure B. Definition of switching losses

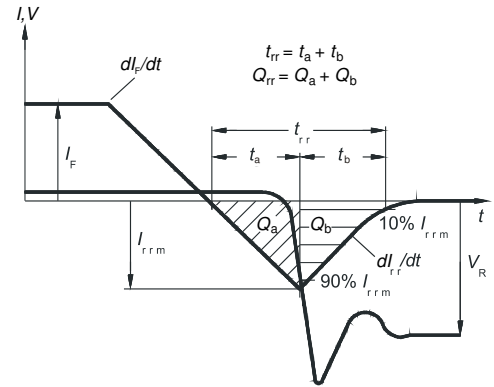

Figure C. Definition of diode switching characteristics



Figure D. Thermal equivalent circuit

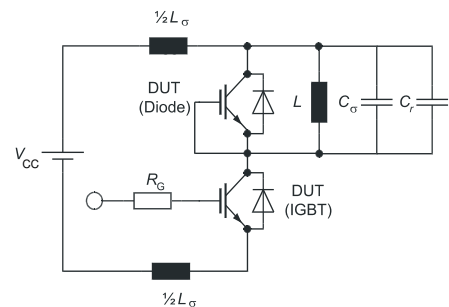

Figure E. Dynamic test circuit
Parasitic inductance L_{σ} ,
parasitic capacitor C_{σ} ,
relief capacitor C_r ,
(only for ZVT switching)

Revision History

IKW50N60DTP

Revision: 2016-02-08, Rev. 2.1

Previous Revision

Revision	Date	Subjects (major changes since last revision)
2.1	-	Release final datasheet

Published by
Infineon Technologies AG
81726 München, Germany
© Infineon Technologies AG 2016.
All Rights Reserved.

Important Notice

The information given in this document shall in no event be regarded as a guarantee of conditions or characteristics ("Beschaffheitsgarantie"). With respect to any examples, hints or any typical values stated herein and/or any information regarding the application of the product, Infineon Technologies hereby disclaims any and all warranties and liabilities of any kind, including without limitation warranties of non-infringement of intellectual property rights of any third party.

In addition, any information given in this document is subject to customer's compliance with its obligations stated in this document and any applicable legal requirements, norms and standards concerning customer's products and any use of the product of Infineon Technologies in customer's applications.

The data contained in this document is exclusively intended for technically trained staff. It is the responsibility of customer's technical departments to evaluate the suitability of the product for the intended application and the completeness of the product information given in this document with respect to such application.

For further information on the product, technology, delivery terms and conditions and prices please contact your nearest Infineon Technologies office (www.infineon.com).

Please note that this product is not qualified according to the AEC Q100 or AEC Q101 documents of the Automotive Electronics Council.

Warnings

Due to technical requirements products may contain dangerous substances. For information on the types in question please contact your nearest Infineon Technologies office.

Except as otherwise explicitly approved by Infineon Technologies in a written document signed by authorized representatives of Infineon Technologies, Infineon Technologies' products may not be used in any applications where a failure of the product or any consequences of the use thereof can reasonably be expected to result in personal injury.

Mouser Electronics

Authorized Distributor

Click to View Pricing, Inventory, Delivery & Lifecycle Information:

[Infineon:](#)

[IKW50N60DTPXKSA1](#)