

Low Noise Silicon Bipolar RF Transistor

- High linearity low noise RF transistor
- 22 dBm OP1dB and 31 dBm OIP3
@ 900 MHz, 8 V, 70 mA
- For UHF / VHF applications
- Driver for multistage amplifiers
- For linear broadband and antenna amplifiers
- Collector design supports 5 V supply voltage
- Pb-free (RoHS compliant) package
- Qualification report according to AEC-Q101 available

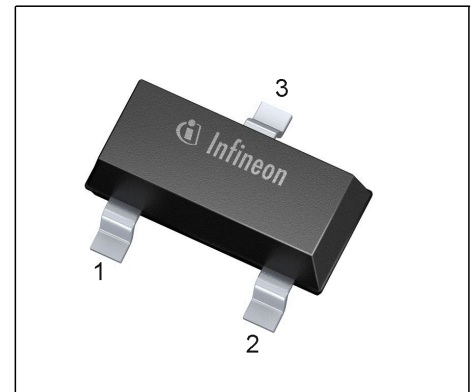

ESD (Electrostatic discharge) sensitive device, observe handling precaution!

| Type | Marking | Pin Configuration | | | Package |
|--------|---------|-------------------|-----|-----|---------|
| BFR106 | R7s | 1=B | 2=E | 3=C | SOT23 |

Maximum Ratings at $T_A = 25\text{ °C}$, unless otherwise specified

| Parameter | Symbol | Value | Unit |
|---|-----------|-------------|------|
| Collector-emitter voltage, $T_A = 25\text{ °C}$ $T_A = -55\text{ °C}$ | V_{CEO} | 16 15 | V |
| Collector-emitter voltage | V_{CES} | 20 | |
| Collector-base voltage | V_{CBO} | 20 | |
| Emitter-base voltage | V_{EBO} | 3 | |
| Collector current | I_C | 210 | mA |
| Base current | I_B | 21 | |
| Total power dissipation ¹⁾ $T_S \leq 76\text{ °C}$ | P_{tot} | 700 | mW |
| Junction temperature | T_J | 150 | °C |
| Storage temperature | T_{Stg} | -55 ... 150 | |

Thermal Resistance

| Parameter | Symbol | Value | Unit |
|--|------------|-------|------|
| Junction - soldering point ²⁾ | R_{thJS} | 105 | K/W |

¹⁾ T_S is measured on the collector lead at the soldering point to the pcb

²⁾ For calculation of R_{thJS} please refer to Application Note AN077 (Thermal Resistance Calculation)

Electrical Characteristics at $T_A = 25\text{ °C}$, unless otherwise specified

| Parameter | Symbol | Values | | | Unit |
|--|---------------|--------|------|------|---------------|
| | | min. | typ. | max. | |
| DC Characteristics | | | | | |
| Collector-emitter breakdown voltage $I_C = 1\text{ mA}$, $I_B = 0$ | $V_{(BR)CEO}$ | 15 | - | - | V |
| Collector-emitter cutoff current $V_{CE} = 20\text{ V}$, $V_{BE} = 0$ $V_{CE} = 10\text{ V}$, $V_{BE} = 0$ | I_{CES} | - | - | 1 | μA |
| Collector-base cutoff current $V_{CB} = 10\text{ V}$, $I_E = 0$ | I_{CBO} | - | 1 | 30 | nA |
| Emitter-base cutoff current $V_{EB} = 2\text{ V}$, $I_C = 0$ | I_{EBO} | - | 1 | 30 | |
| DC current gain $I_C = 70\text{ mA}$, $V_{CE} = 8\text{ V}$, pulse measured | h_{FE} | 70 | 100 | 140 | - |

Electrical Characteristics at $T_A = 25\text{ °C}$, unless otherwise specified

| Parameter | Symbol | Values | | | Unit |
|--|------------|--------|------|------|------|
| | | min. | typ. | max. | |
| AC Characteristics (verified by random sampling) | | | | | |
| Transition frequency $I_C = 70\text{ mA}$, $V_{CE} = 8\text{ V}$, $f = 500\text{ MHz}$ | f_T | 3.5 | 5 | - | GHz |
| Collector-base capacitance $V_{CB} = 10\text{ V}$, $f = 1\text{ MHz}$, $V_{BE} = 0$, emitter grounded | C_{cb} | - | 0.85 | 1.2 | pF |
| Collector emitter capacitance $V_{CE} = 10\text{ V}$, $f = 1\text{ MHz}$, $V_{BE} = 0$, base grounded | C_{ce} | - | 0.27 | - | |
| Emitter-base capacitance $V_{EB} = 0.5\text{ V}$, $f = 1\text{ MHz}$, $V_{CB} = 0$, collector grounded | C_{eb} | - | 3.9 | - | |
| Minimum noise figure $I_C = 20\text{ mA}$, $V_{CE} = 8\text{ V}$, $Z_S = Z_{Sopt}$, $f = 900\text{ MHz}$ $I_C = 20\text{ mA}$, $V_{CE} = 8\text{ V}$, $Z_S = Z_{Sopt}$, $f = 1.8\text{ GHz}$ | NF_{min} | - | 1.8 | - | dB |
| | | - | 3 | - | |

Electrical Characteristics at $T_A = 25\text{ }^\circ\text{C}$, unless otherwise specified

| Parameter | Symbol | Values | | | Unit |
|---|---------------|--------|------|------|------|
| | | min. | typ. | max. | |
| AC Characteristics (verified by random sampling) | | | | | |
| Power gain, maximum available ¹⁾ $I_C = 70\text{ mA}$, $V_{CE} = 8\text{ V}$, $Z_S = Z_{Sopt}$, $Z_L = Z_{Lopt}$, $f = 900\text{ MHz}$ $I_C = 70\text{ mA}$, $V_{CE} = 8\text{ V}$, $Z_S = Z_{Sopt}$, $Z_L = Z_{Lopt}$, $f = 1.8\text{ GHz}$ | G_{ma} | - | 13 | - | dB |
| | | - | 8.5 | - | |
| Transducer gain $I_C = 70\text{ mA}$, $V_{CE} = 8\text{ V}$, $Z_S = Z_L = 50\ \Omega$, $f = 900\text{ MHz}$ $I_C = 70\text{ mA}$, $V_{CE} = 8\text{ V}$, $Z_S = Z_L = 50\ \Omega$, $f = 1.8\text{ GHz}$ | $ S_{21e} ^2$ | - | 10.5 | - | dB |
| | | - | 5 | - | |
| Third order intercept point at output ²⁾ $V_{CE} = 8\text{ V}$, $I_C = 70\text{ mA}$, $f = 0.9\text{ GHz}$, $Z_S = Z_L = 50\ \Omega$ | IP_3 | - | 31 | - | dBm |
| 1dB compression point $I_C = 70\text{ mA}$, $V_{CE} = 8\text{ V}$, $Z_S = Z_L = 50\ \Omega$, $f = 0.9\text{ GHz}$ | P_{-1dB} | - | 22 | - | |

$$^1G_{ma} = |S_{21e}| / |S_{12e}| (k - (k^2 - 1)^{1/2})$$

²⁾ IP_3 value depends on termination of all intermodulation frequency components.

Termination used for this measurement is $50\ \Omega$ from 0.1 MHz to 6 GHz

Total power dissipation $P_{\text{tot}} = f(T_S)$

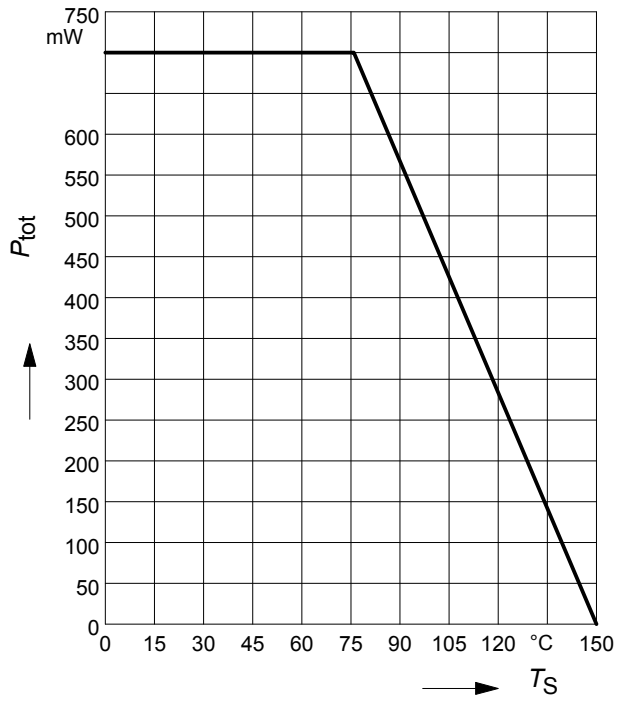

SPICE GP Model

For the SPICE Gummel Poon (GP) model as well as for the S-parameters (including noise parameters) please refer to our internet website www.infineon.com/rf.models.

Please consult our website and download the latest versions before actually starting your design.

Package Outline

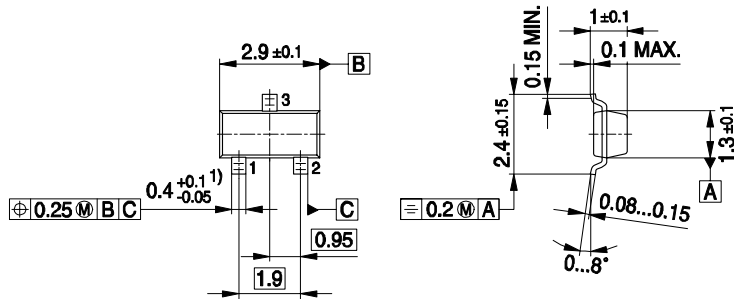
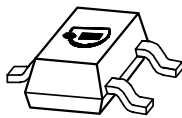

1) Lead width can be 0.6 max. in dambar area

SOT23-PO V08

Foot Print

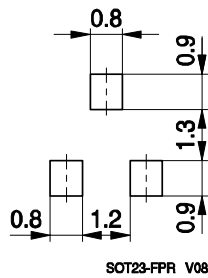

Marking Layout

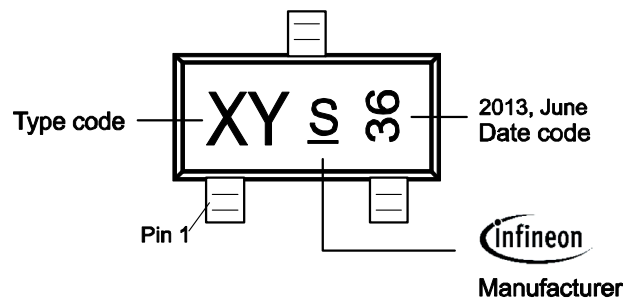

Standard Packing

Reel o 180 mm: 3.000 Pieces / Reel
 Reel o 330 mm = 10.000 Pieces / Reel

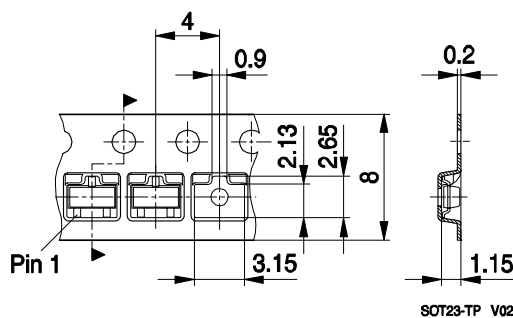

Edition 2009-11-16

**Published by
Infineon Technologies AG
81726 Munich, Germany**

**© 2009 Infineon Technologies AG
All Rights Reserved.**

Legal Disclaimer

The information given in this document shall in no event be regarded as a guarantee of conditions or characteristics. With respect to any examples or hints given herein, any typical values stated herein and/or any information regarding the application of the device, Infineon Technologies hereby disclaims any and all warranties and liabilities of any kind, including without limitation, warranties of non-infringement of intellectual property rights of any third party.

Information

For further information on technology, delivery terms and conditions and prices, please contact the nearest Infineon Technologies Office ([<www.infineon.com>](http://www.infineon.com)).

Warnings

Due to technical requirements, components may contain dangerous substances. For information on the types in question, please contact the nearest Infineon Technologies Office.

Infineon Technologies components may be used in life-support devices or systems only with the express written approval of Infineon Technologies, if a failure of such components can reasonably be expected to cause the failure of that life-support device or system or to affect the safety or effectiveness of that device or system. Life support devices or systems are intended to be implanted in the human body or to support and/or maintain and sustain and/or protect human life. If they fail, it is reasonable to assume that the health of the user or other persons may be endangered.

Mouser Electronics

Authorized Distributor

Click to View Pricing, Inventory, Delivery & Lifecycle Information:

[Infineon:](#)

[BFR 106 E6327](#)