

## Fast IGBT in NPT-technology

- 75% lower  $E_{off}$  compared to previous generation combined with low conduction losses
- Short circuit withstand time – 10  $\mu$ s
- Designed for:
  - Motor controls
  - Inverter
- NPT-Technology for 600V applications offers:
  - very tight parameter distribution
  - high ruggedness, temperature stable behaviour
  - parallel switching capability
- Qualified according to JEDEC<sup>1</sup> for target applications
- Pb-free lead plating; RoHS compliant
- Complete product spectrum and PSpice Models : <http://www.infineon.com/igbt/>

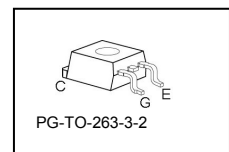
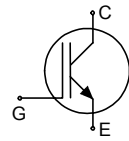

Type	$V_{CE}$	$I_C$	$V_{CE(sat)}$	$T_j$	Marking	Package
SGB10N60A	600V	10A	2.3V	150°C	G10N60A	PG-TO-263-3-2

### Maximum Ratings

Parameter	Symbol	Value	Unit
Collector-emitter voltage	$V_{CE}$	600	V
DC collector current	$I_C$	20	A
$T_C = 25^\circ\text{C}$		10.6	
$T_C = 100^\circ\text{C}$			
Pulsed collector current, $t_p$ limited by $T_{jmax}$	$I_{Cpuls}$	40	
Turn off safe operating area	-	40	
$V_{CE} \leq 600\text{V}, T_j \leq 150^\circ\text{C}$			
Gate-emitter voltage	$V_{GE}$	$\pm 20$	V
Avalanche energy, single pulse	$E_{AS}$	70	mJ
$I_C = 10\text{ A}, V_{CC} = 50\text{ V}, R_{GE} = 25\ \Omega$ , start at $T_j = 25^\circ\text{C}$			
Short circuit withstand time <sup>2</sup>	$t_{SC}$	10	$\mu$ s
$V_{GE} = 15\text{V}, V_{CC} \leq 600\text{V}, T_j \leq 150^\circ\text{C}$			
Power dissipation	$P_{tot}$	92	W
$T_C = 25^\circ\text{C}$			
Operating junction and storage temperature	$T_j, T_{stg}$	-55...+150	$^\circ\text{C}$
Soldering temperature (reflow soldering MSL1)		245	

<sup>1</sup> J-STD-020 and JESD-022

<sup>2</sup> Allowed number of short circuits: <1000; time between short circuits: >1s.

## Thermal Resistance

Parameter	Symbol	Conditions	Max. Value	Unit
<b>Characteristic</b>				
IGBT thermal resistance, junction – case	$R_{thJC}$		1.35	K/W
Thermal resistance, junction – ambient <sup>1)</sup>	$R_{thJA}$		40	

## Electrical Characteristic, at $T_j = 25\text{ }^\circ\text{C}$ , unless otherwise specified

Parameter	Symbol	Conditions	Value			Unit
			min.	Typ.	max.	
<b>Static Characteristic</b>						
Collector-emitter breakdown voltage	$V_{(BR)CES}$	$V_{GE}=0V, I_C=500\mu A$	600	-	-	V
Collector-emitter saturation voltage	$V_{CE(sat)}$	$V_{GE} = 15V, I_C=10A$	1.7	2	2.4	
		$T_j=25^\circ\text{C}$ $T_j=150^\circ\text{C}$	-	2.3	2.8	
Gate-emitter threshold voltage	$V_{GE(th)}$	$I_C=300\mu A, V_{CE}=V_{GE}$	3	4	5	
Zero gate voltage collector current	$I_{CES}$	$V_{CE}=600V, V_{GE}=0V$ $T_j=25^\circ\text{C}$ $T_j=150^\circ\text{C}$	-	-	40	$\mu A$
			-	-	1500	
Gate-emitter leakage current	$I_{GES}$	$V_{CE}=0V, V_{GE}=20V$	-	-	100	nA
Transconductance	$g_{fs}$	$V_{CE}=20V, I_C=10A$	-	6.7	-	S
<b>Dynamic Characteristic</b>						
Input capacitance	$C_{iss}$	$V_{CE}=25V,$ $V_{GE}=0V,$ $f=1\text{MHz}$	-	550	660	pF
Output capacitance	$C_{oss}$		-	62	75	
Reverse transfer capacitance	$C_{riss}$		-	42	51	
Gate charge	$Q_{Gate}$	$V_{CC}=480V, I_C=10A$ $V_{GE}=15V$	-	52	68	nC
Internal emitter inductance measured 5mm (0.197 in.) from case	$L_E$		-	7	-	nH
Short circuit collector current <sup>2)</sup>	$I_{C(SC)}$	$V_{GE}=15V, t_{SC}\leq 10\mu s$ $V_{CC}\leq 600V,$ $T_j\leq 150^\circ\text{C}$	-	100	-	A

<sup>1)</sup> Device on 50mm\*50mm\*1.5mm epoxy PCB FR4 with 6cm<sup>2</sup> (one layer, 70 $\mu$ m thick) copper area for collector connection. PCB is vertical without blown air.

<sup>2)</sup> Allowed number of short circuits: <1000; time between short circuits: >1s.

### Switching Characteristic, Inductive Load, at $T_j=25\text{ }^\circ\text{C}$

Parameter	Symbol	Conditions	Value			Unit	
			min.	typ.	max.		
<b>IGBT Characteristic</b>							
Turn-on delay time	$t_{d(on)}$	$T_j=25\text{ }^\circ\text{C}$ , $V_{CC}=400\text{V}$ , $I_C=10\text{A}$ , $V_{GE}=0/15\text{V}$ , $R_G=25\Omega$ , $L_{\sigma}^{(1)}=180\text{nH}$ , $C_{\sigma}^{(1)}=55\text{pF}$	-	28	34	ns	
Rise time	$t_r$		-	12	15		
Turn-off delay time	$t_{d(off)}$		-	178	214		
Fall time	$t_f$		-	24	29		
Turn-on energy	$E_{on}$		Energy losses include "tail" and diode reverse recovery.	-	0.15	0.173	mJ
Turn-off energy	$E_{off}$			-	0.17	0.221	
Total switching energy	$E_{ts}$			-	0.320	0.394	

### Switching Characteristic, Inductive Load, at $T_j=150\text{ }^\circ\text{C}$

Parameter	Symbol	Conditions	Value			Unit	
			min.	typ.	max.		
<b>IGBT Characteristic</b>							
Turn-on delay time	$t_{d(on)}$	$T_j=150\text{ }^\circ\text{C}$ $V_{CC}=400\text{V}$ , $I_C=10\text{A}$ , $V_{GE}=0/15\text{V}$ , $R_G=25\Omega$ $L_{\sigma}^{(1)}=180\text{nH}$ , $C_{\sigma}^{(1)}=55\text{pF}$	-	28	34	ns	
Rise time	$t_r$		-	12	15		
Turn-off delay time	$t_{d(off)}$		-	198	238		
Fall time	$t_f$		-	26	32		
Turn-on energy	$E_{on}$		Energy losses include "tail" and diode reverse recovery.	-	0.260	0.299	mJ
Turn-off energy	$E_{off}$			-	0.280	0.364	
Total switching energy	$E_{ts}$			-	0.540	0.663	

<sup>1)</sup> Leakage inductance  $L_{\sigma}$  and Stray capacity  $C_{\sigma}$  due to dynamic test circuit in Figure E.

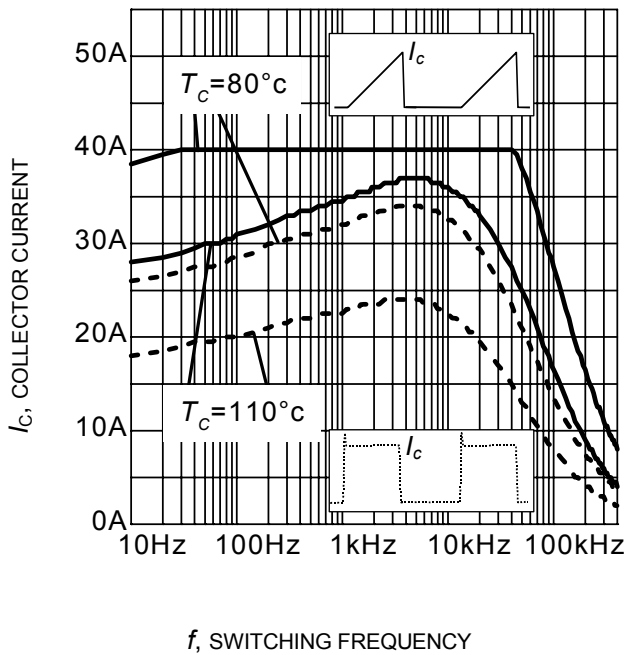

$f$ , SWITCHING FREQUENCY

**Figure 1. Collector current as a function of switching frequency**  
 ( $T_j \leq 150^\circ\text{C}$ ,  $D = 0.5$ ,  $V_{CE} = 400\text{V}$ ,  
 $V_{GE} = 0/+15\text{V}$ ,  $R_G = 25\Omega$ )

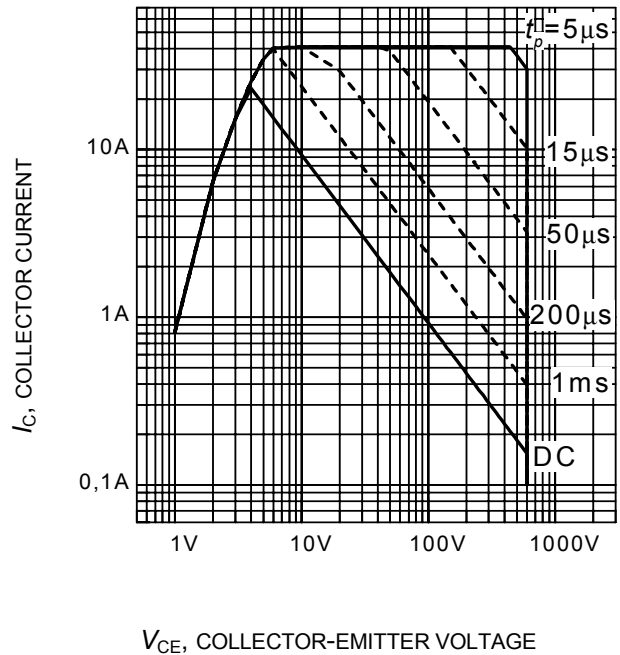

$V_{CE}$ , COLLECTOR-EMITTER VOLTAGE

**Figure 2. Safe operating area**  
 ( $D = 0$ ,  $T_C = 25^\circ\text{C}$ ,  $T_j \leq 150^\circ\text{C}$ )

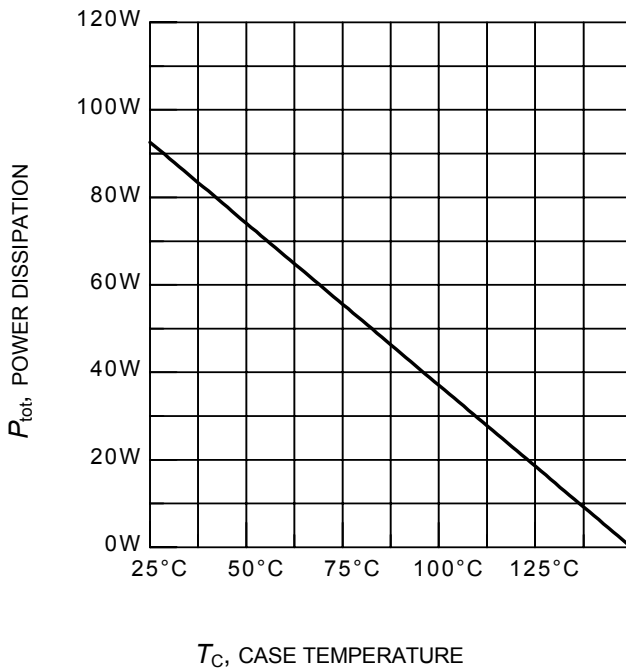

$T_C$ , CASE TEMPERATURE

**Figure 3. Power dissipation as a function of case temperature**  
 ( $T_j \leq 150^\circ\text{C}$ )

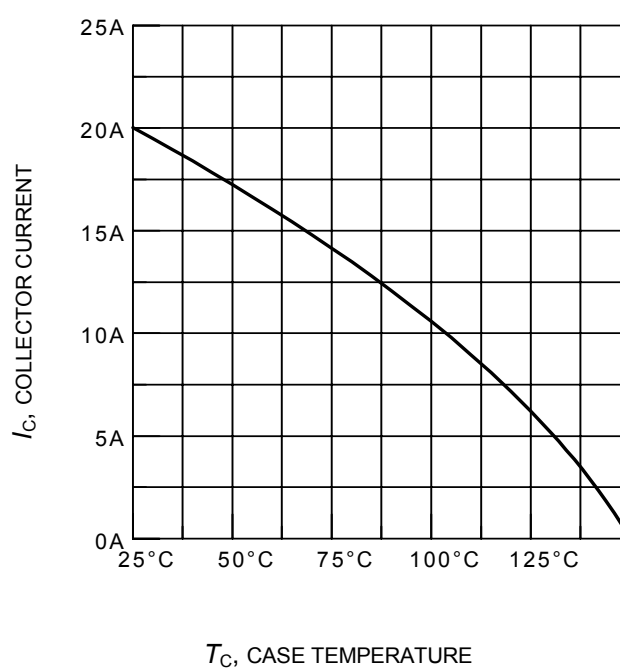

$T_C$ , CASE TEMPERATURE

**Figure 4. Collector current as a function of case temperature**  
 ( $V_{GE} \leq 15\text{V}$ ,  $T_j \leq 150^\circ\text{C}$ )

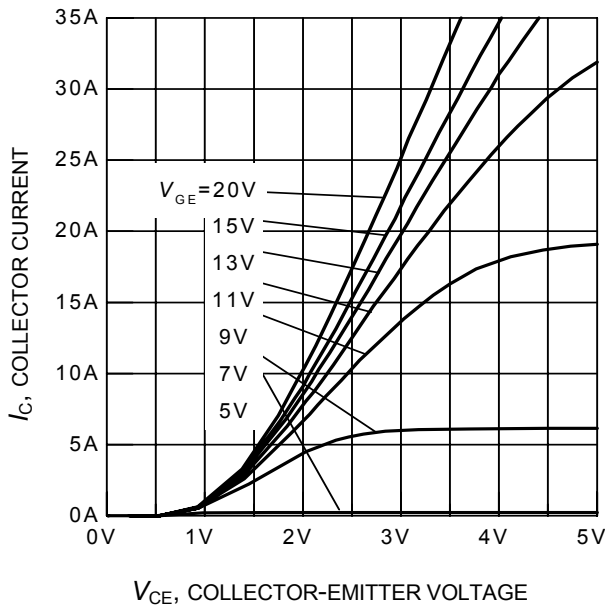

**Figure 5. Typical output characteristics**  
( $T_j = 25^\circ\text{C}$ )

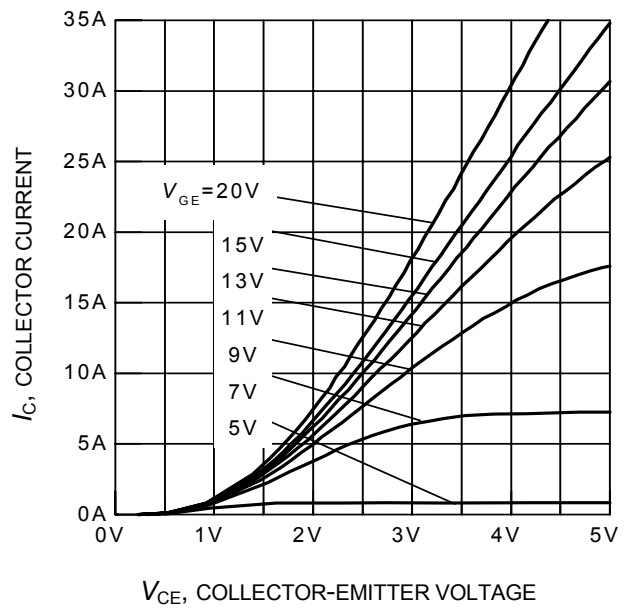

**Figure 6. Typical output characteristics**  
( $T_j = 150^\circ\text{C}$ )

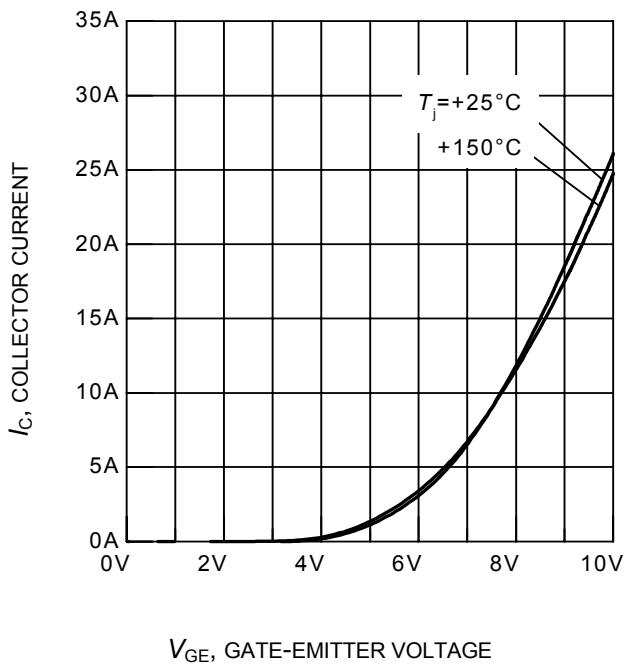

**Figure 7. Typical transfer characteristics**  
( $V_{CE} = 10\text{V}$ )

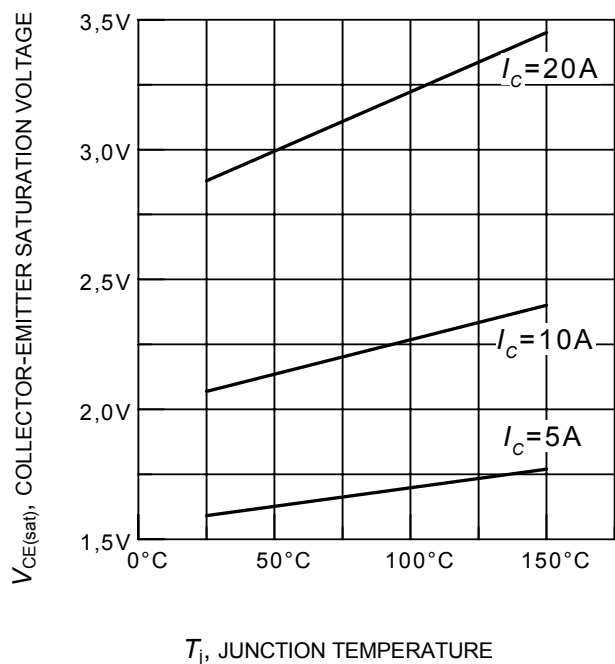

**Figure 8. Typical collector-emitter saturation voltage as a function of junction temperature**  
( $V_{GE} = 15\text{V}$ )

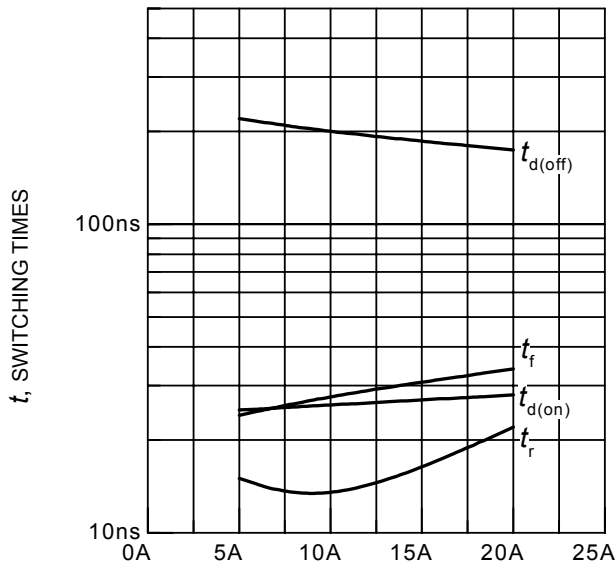

$I_C$ , COLLECTOR CURRENT

**Figure 9. Typical switching times as a function of collector current**

(inductive load,  $T_j = 150^\circ\text{C}$ ,  $V_{CE} = 400\text{V}$ ,  $V_{GE} = 0/+15\text{V}$ ,  $R_G = 25\Omega$ , Dynamic test circuit in Figure E)

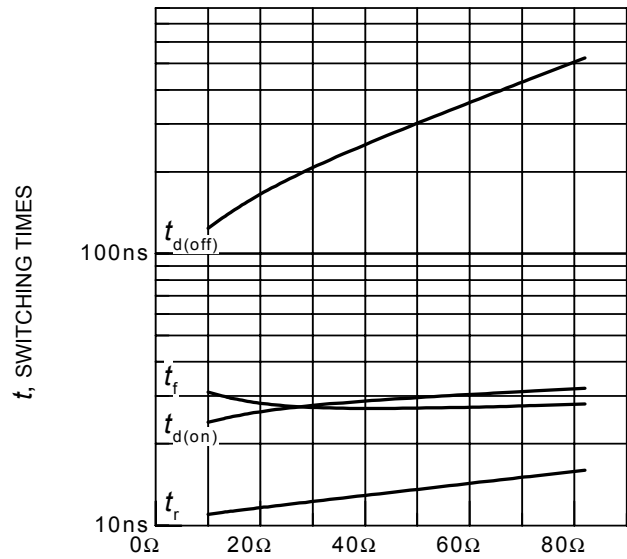

$R_G$ , GATE RESISTOR

**Figure 10. Typical switching times as a function of gate resistor**

(inductive load,  $T_j = 150^\circ\text{C}$ ,  $V_{CE} = 400\text{V}$ ,  $V_{GE} = 0/+15\text{V}$ ,  $I_C = 10\text{A}$ , Dynamic test circuit in Figure E)

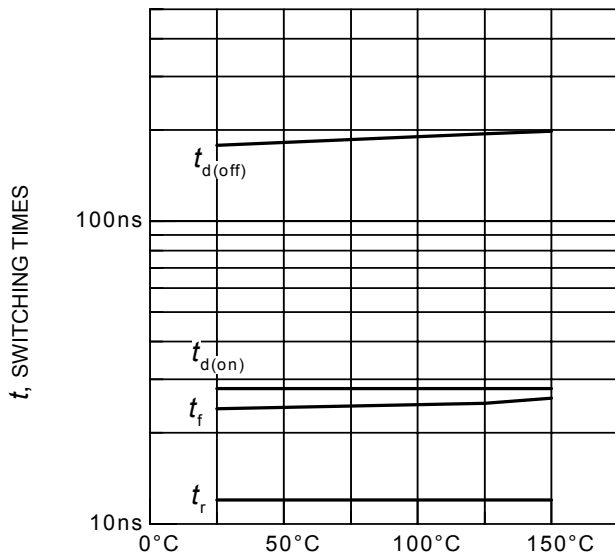

$T_j$ , JUNCTION TEMPERATURE

**Figure 11. Typical switching times as a function of junction temperature**

(inductive load,  $V_{CE} = 400\text{V}$ ,  $V_{GE} = 0/+15\text{V}$ ,  $I_C = 10\text{A}$ ,  $R_G = 25\Omega$ , Dynamic test circuit in Figure E)

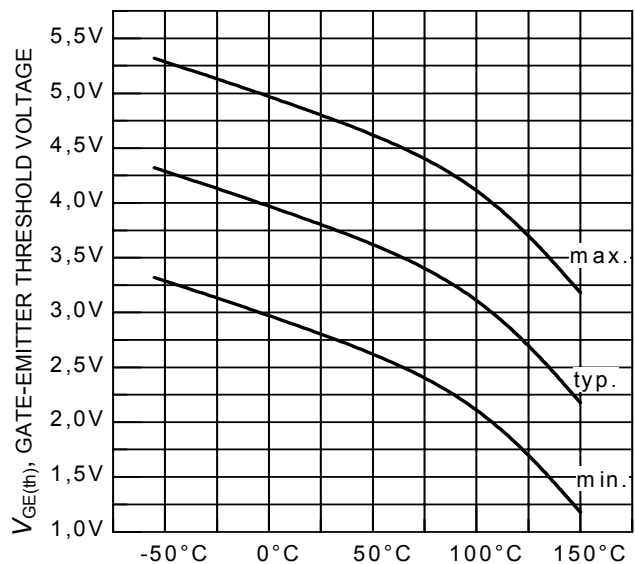

$T_j$ , JUNCTION TEMPERATURE

**Figure 12. Gate-emitter threshold voltage as a function of junction temperature**

( $I_C = 0.3\text{mA}$ )

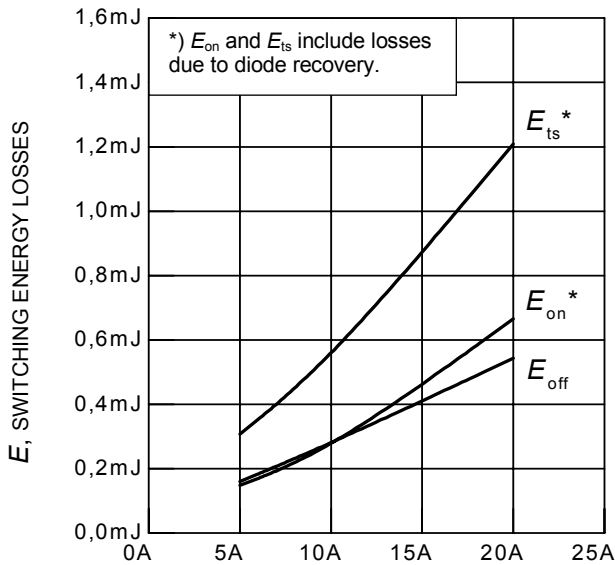

$I_C$ , COLLECTOR CURRENT

**Figure 13. Typical switching energy losses as a function of collector current**  
(inductive load,  $T_j = 150^\circ\text{C}$ ,  $V_{CE} = 400\text{V}$ ,  $V_{GE} = 0/+15\text{V}$ ,  $R_G = 25\Omega$ , Dynamic test circuit in Figure E)

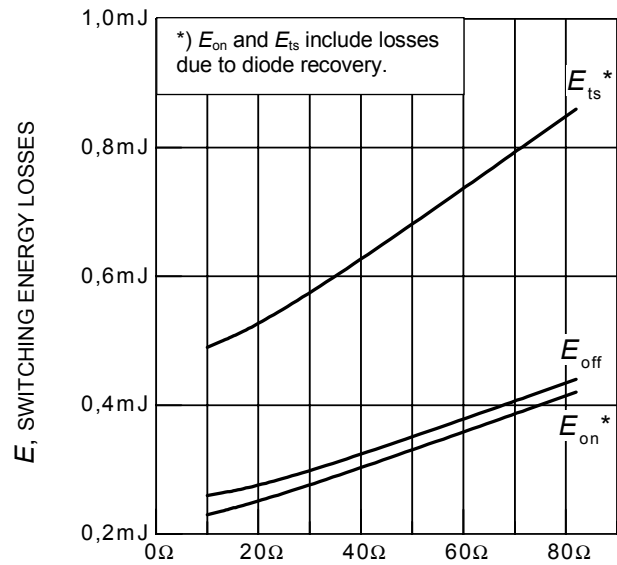

$R_G$ , GATE RESISTOR

**Figure 14. Typical switching energy losses as a function of gate resistor**  
(inductive load,  $T_j = 150^\circ\text{C}$ ,  $V_{CE} = 400\text{V}$ ,  $V_{GE} = 0/+15\text{V}$ ,  $I_C = 10\text{A}$ , Dynamic test circuit in Figure E)

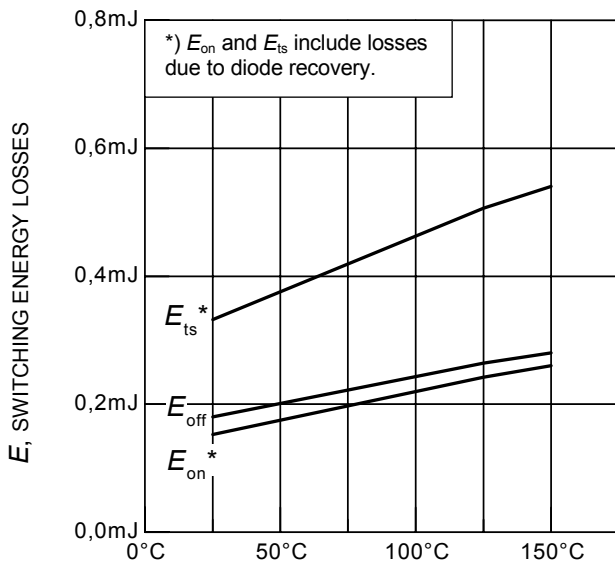

$T_j$ , JUNCTION TEMPERATURE

**Figure 15. Typical switching energy losses as a function of junction temperature**  
(inductive load,  $V_{CE} = 400\text{V}$ ,  $V_{GE} = 0/+15\text{V}$ ,  $I_C = 10\text{A}$ ,  $R_G = 25\Omega$ , Dynamic test circuit in Figure E)

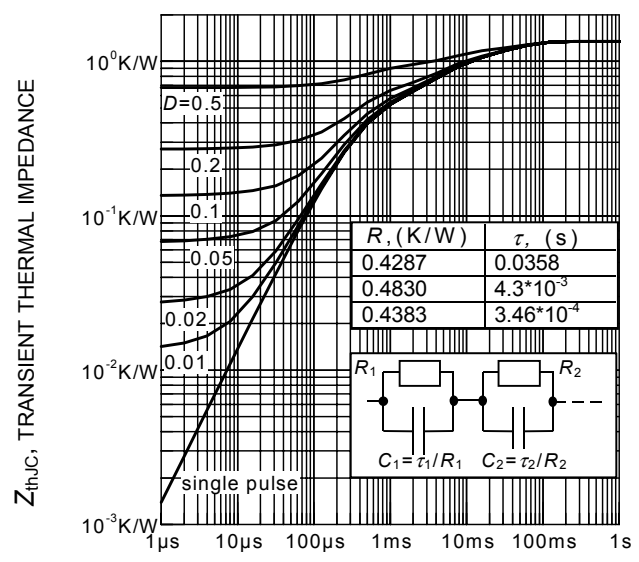

$t_p$ , PULSE WIDTH

**Figure 16. IGBT transient thermal impedance as a function of pulse width**  
( $D = t_p / T$ )

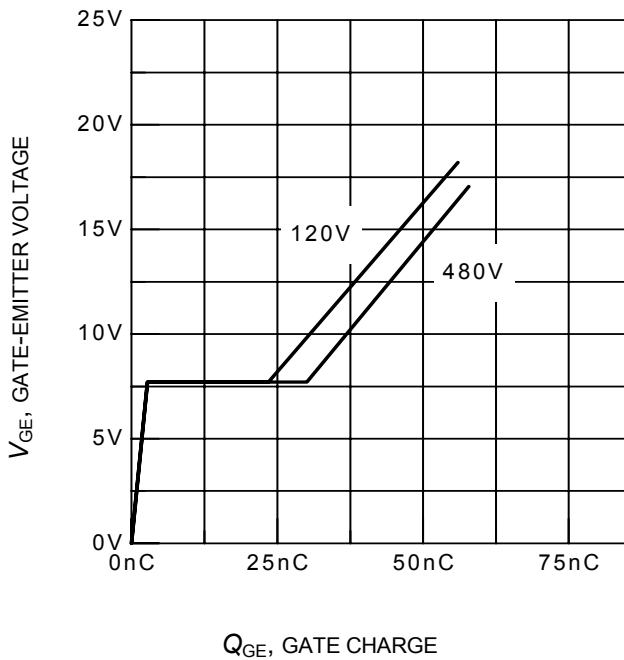

$Q_{GE}$ , GATE CHARGE  
**Figure 17. Typical gate charge**  
 ( $I_C = 10A$ )

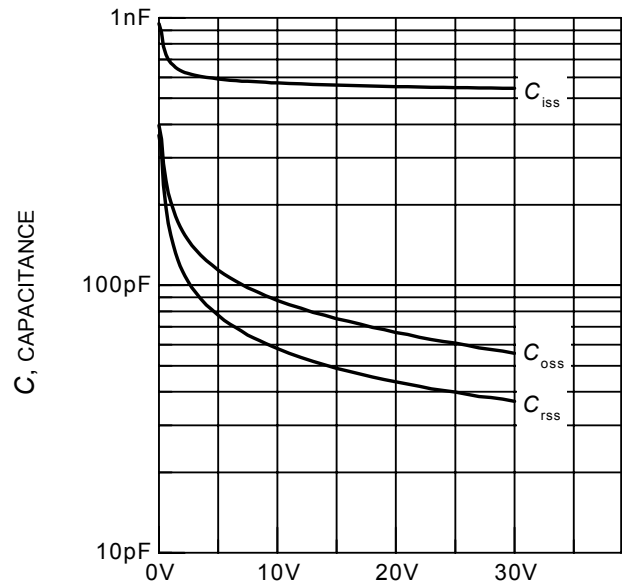

$V_{CE}$ , COLLECTOR-EMITTER VOLTAGE  
**Figure 18. Typical capacitance as a function of collector-emitter voltage**  
 ( $V_{GE} = 0V, f = 1MHz$ )

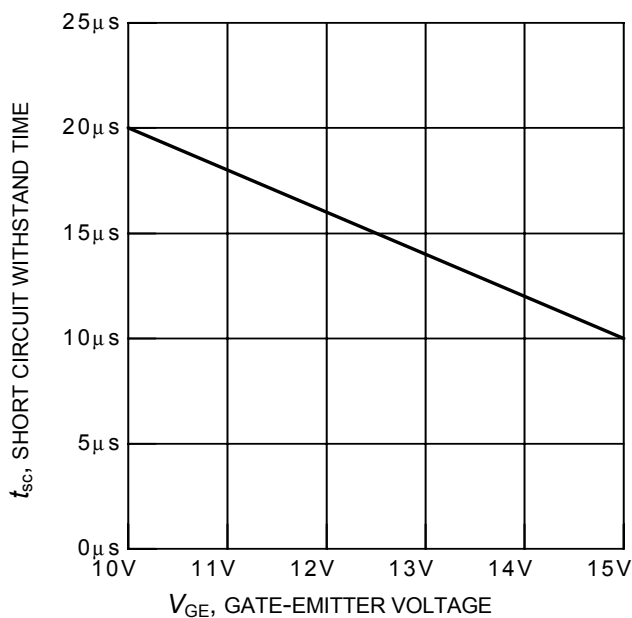

$t_{sc}$ , SHORT CIRCUIT WITHSTAND TIME  
**Figure 19. Short circuit withstand time as a function of gate-emitter voltage**  
 ( $V_{CE} = 600V, \text{start at } T_j = 25^\circ C$ )

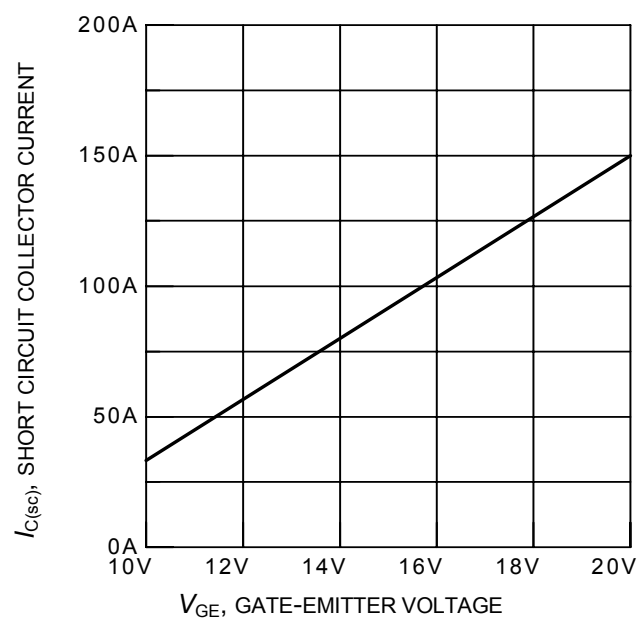

$I_{C(sc)}$ , SHORT CIRCUIT COLLECTOR CURRENT  
**Figure 20. Typical short circuit collector current as a function of gate-emitter voltage**  
 ( $V_{CE} \leq 600V, T_j = 150^\circ C$ )



## PG-TO263-3-2

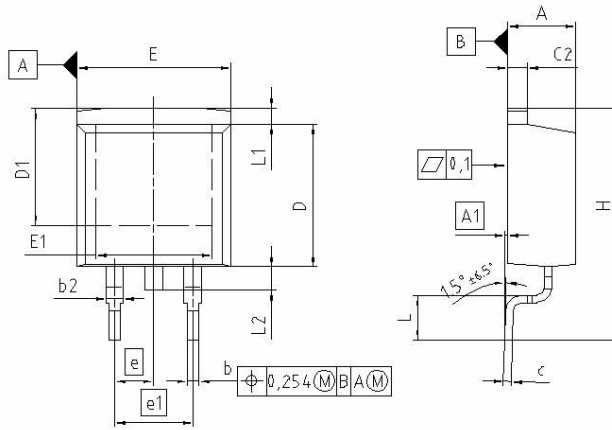

### FOOTPRINT

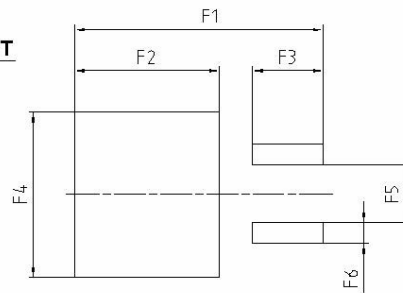

DIM	MILLIMETERS		INCHES	
	MIN	MAX	MIN	MAX
A	4.300	4.572	0.169	0.180
A1	0.000	0.254	0.000	0.010
b	0.850	0.850	0.026	0.033
b2	0.950	1.321	0.037	0.052
c	0.330	0.850	0.013	0.026
c2	0.170	1.400	0.046	0.055
D	8.509	9.450	0.335	0.372
D1	7.100	-	0.280	-
E	9.800	10.312	0.386	0.406
E1	6.500	-	0.256	-
e	2.540		0.100	
e1	5.090		0.200	
N	2		2	
H	14.605	15.875	0.575	0.625
L	2.200	3.000	0.087	0.118
L1	-	1.600	-	0.063
L2	1.000	1.778	0.039	0.070
F1	16.050	16.250	0.632	0.640
F2	9.300	9.500	0.366	0.374
F3	4.500	4.700	0.177	0.185
F4	10.700	10.900	0.421	0.429
F5	3.630	3.830	0.143	0.151
F6	1.100	1.300	0.043	0.051

**REFERENCE**  
JEDEC TO263

**SCALE**

**EUROPEAN PROJECTION**

**ISSUE DATE**  
12-02-2006

**FILE**  
TO263\_2

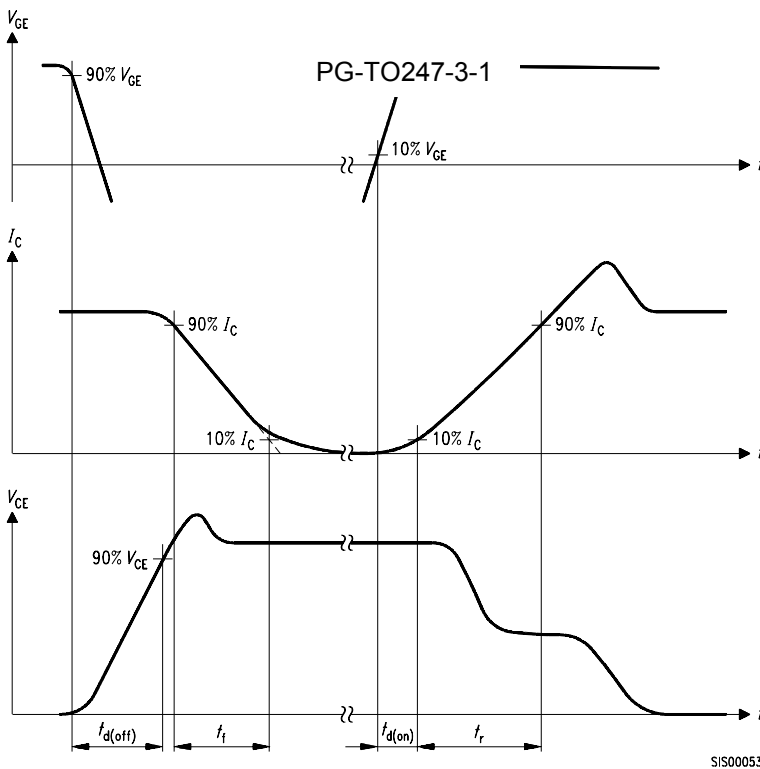

**Figure A. Definition of switching times**

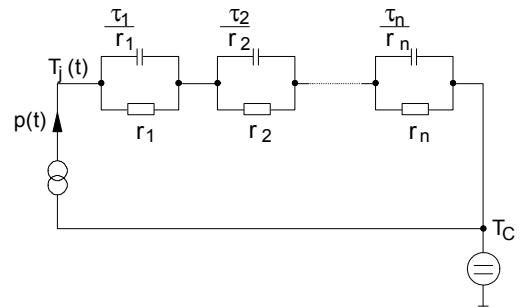

**Figure D. Thermal equivalent circuit**

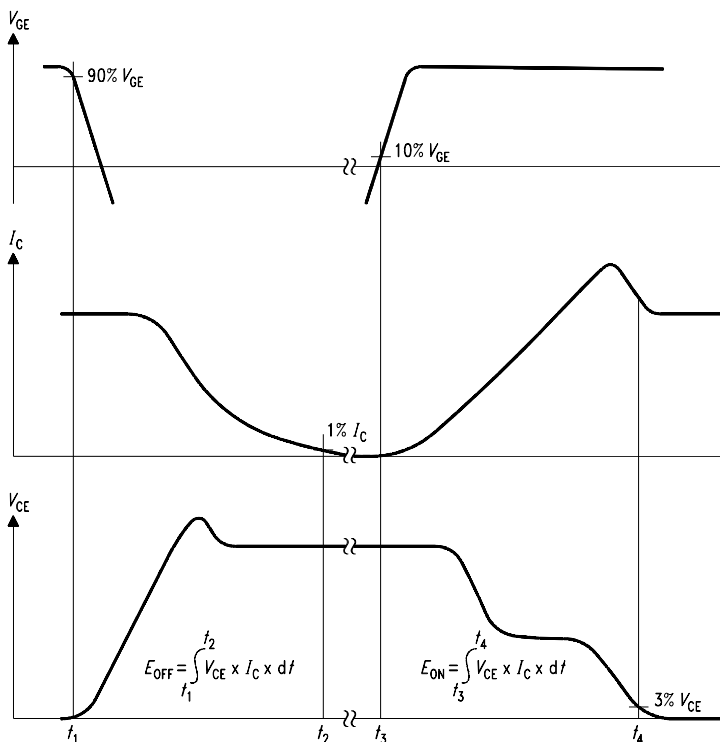

**Figure B. Definition of switching losses**

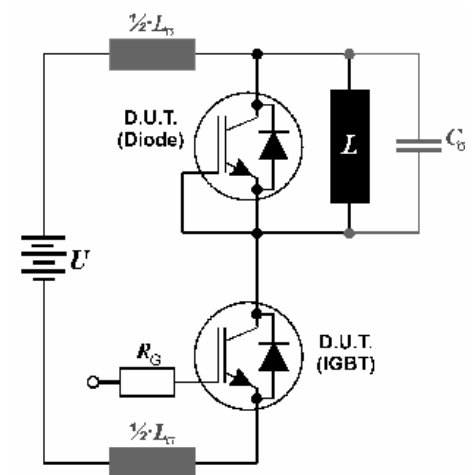

**Figure E. Dynamic test circuit**  
Leakage inductance  $L_{\sigma} = 180\text{nH}$   
and Stray capacity  $C_{\sigma} = 55\text{pF}$ .

**Edition 2006-01**

**Published by  
Infineon Technologies AG  
81726 München, Germany**

**© Infineon Technologies AG 7/11/07.**

**All Rights Reserved.**

**Attention please!**

The information given in this data sheet shall in no event be regarded as a guarantee of conditions or characteristics ("Beschaffenheitsgarantie"). With respect to any examples or hints given herein, any typical values stated herein and/or any information regarding the application of the device, Infineon Technologies hereby disclaims any and all warranties and liabilities of any kind, including without limitation warranties of non-infringement of intellectual property rights of any third party.

**Information**

For further information on technology, delivery terms and conditions and prices please contact your nearest Infineon Technologies Office ([www.infineon.com](http://www.infineon.com)).

**Warnings**

Due to technical requirements components may contain dangerous substances. For information on the types in question please contact your nearest Infineon Technologies Office.

Infineon Technologies Components may only be used in life-support devices or systems with the express written approval of Infineon Technologies, if a failure of such components can reasonably be expected to cause the failure of that life-support device or system, or to affect the safety or effectiveness of that device or system. Life support devices or systems are intended to be implanted in the human body, or to support and/or maintain and sustain and/or protect human life. If they fail, it is reasonable to assume that the health of the user or other persons may be endangered.

# Mouser Electronics

Authorized Distributor

Click to View Pricing, Inventory, Delivery & Lifecycle Information:

[Infineon:](#)

[SGB10N60A](#)