

Cool MOS™ Power Transistor

$V_{DS} @ T_{jmax}$	650	V
$R_{DS(on)}$	0.19	Ω
I_D	20.7	A

Feature

- New revolutionary high voltage technology
- Ultra low gate charge
- Periodic avalanche rated
- Extreme dv/dt rated
- High peak current capability
- Improved transconductance
- Qualified according to JEDEC⁰⁾ for target applications

PG-TO263

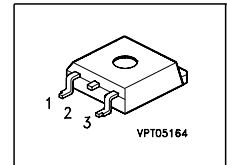

Type	Package	Ordering Code	Marking
SPB20N60C3	PG-TO263	Q67040-S4397	20N60C3

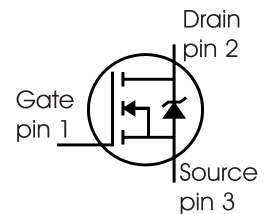
Maximum Ratings

Parameter	Symbol	Value		Unit
		SPB		
Continuous drain current $T_C = 25\text{ °C}$ $T_C = 100\text{ °C}$	I_D	20.7 13.1		A
Pulsed drain current, t_p limited by T_{jmax}	$I_{D\text{ puls}}$	62.1		A
Avalanche energy, single pulse $I_D=10\text{A}$, $V_{DD}=50\text{V}$	E_{AS}	690		mJ
Avalanche energy, repetitive t_{AR} limited by T_{jmax} ²⁾ $I_D=20\text{A}$, $V_{DD}=50\text{V}$	E_{AR}	1		
Avalanche current, repetitive t_{AR} limited by T_{jmax}	I_{AR}	20		A
Gate source voltage static	V_{GS}	± 20		V
Gate source voltage AC ($f > 1\text{Hz}$)	V_{GS}	± 30		
Power dissipation, $T_C = 25\text{ °C}$	P_{tot}	208		W
Operating and storage temperature	T_j, T_{stg}	-55...+150		°C
Reverse diode dv/dt ⁷⁾	dv/dt	15		V/ns

Maximum Ratings

Parameter	Symbol	Value	Unit
Drain Source voltage slope $V_{DS} = 480\text{ V}$, $I_D = 20.7\text{ A}$, $T_j = 125\text{ °C}$	dv/dt	50	V/ns

Thermal Characteristics

Parameter	Symbol	Values			Unit
		min.	typ.	max.	
Thermal resistance, junction - case	R_{thJC}	-	-	0.6	K/W
		-	-		
Thermal resistance, junction - ambient, leaded	R_{thJA}	-	-	62	
		-	-		
SMD version, device on PCB: @ min. footprint @ 6 cm ² cooling area ³⁾	R_{thJA}	-	-	62	
		-	35	-	
Soldering temperature, reflow soldering, MSL1	T_{sold}	-	-	260	°C

Electrical Characteristics, at $T_j=25\text{ °C}$ unless otherwise specified

Parameter	Symbol	Conditions	Values			Unit
			min.	typ.	max.	
Drain-source breakdown voltage	$V_{(BR)DSS}$	$V_{GS}=0\text{V}$, $I_D=0.25\text{mA}$	600	-	-	V
Drain-Source avalanche breakdown voltage	$V_{(BR)DS}$	$V_{GS}=0\text{V}$, $I_D=20\text{A}$	-	700	-	
Gate threshold voltage	$V_{GS(th)}$	$I_D=1000\mu\text{A}$, $V_{GS}=V_{DS}$	2.1	3	3.9	
Zero gate voltage drain current	I_{DSS}	$V_{DS}=600\text{V}$, $V_{GS}=0\text{V}$, $T_j=25\text{ °C}$ $T_j=150\text{ °C}$	-	0.1	1	μA
			-	-	100	
Gate-source leakage current	I_{GSS}	$V_{GS}=30\text{V}$, $V_{DS}=0\text{V}$	-	-	100	nA
Drain-source on-state resistance	$R_{DS(on)}$	$V_{GS}=10\text{V}$, $I_D=13.1\text{A}$, $T_j=25\text{ °C}$ $T_j=150\text{ °C}$	-	0.16	0.19	Ω
			-	0.43	-	
Gate input resistance	R_G	$f=1\text{MHz}$, open drain	-	0.54	-	

Electrical Characteristics

Parameter	Symbol	Conditions	Values			Unit
			min.	typ.	max.	
Transconductance	g_{fs}	$V_{DS} \geq 2 \cdot I_D \cdot R_{DS(on)max}$, $I_D = 13.1A$	-	17.5	-	S
Input capacitance	C_{iss}	$V_{GS} = 0V$, $V_{DS} = 25V$,	-	2400	-	pF
Output capacitance	C_{oss}	$f = 1MHz$	-	780	-	
Reverse transfer capacitance	C_{rss}		-	50	-	
Effective output capacitance, ⁵⁾ energy related	$C_{o(er)}$	$V_{GS} = 0V$, $V_{DS} = 0V$ to 480V	-	83	-	
Effective output capacitance, ⁶⁾ time related	$C_{o(tr)}$		-	160	-	
Turn-on delay time	$t_{d(on)}$	$V_{DD} = 380V$, $V_{GS} = 0/13V$, $I_D = 20.7A$, $R_G = 3.6\Omega$, $T_j = 125$	-	10	-	ns
Rise time	t_r	$V_{DD} = 380V$, $V_{GS} = 0/13V$,	-	5	-	
Turn-off delay time	$t_{d(off)}$	$I_D = 20.7A$,	-	67	100	
Fall time	t_f	$R_G = 3.6\Omega$	-	4.5	12	

Gate Charge Characteristics

Gate to source charge	Q_{gs}	$V_{DD} = 480V$, $I_D = 20.7A$	-	11	-	nC
Gate to drain charge	Q_{gd}		-	33	-	
Gate charge total	Q_g	$V_{DD} = 480V$, $I_D = 20.7A$, $V_{GS} = 0$ to 10V	-	87	114	
Gate plateau voltage	$V_{(plateau)}$	$V_{DD} = 480V$, $I_D = 20.7A$	-	5.5	-	V

⁰J-STD20 and JESD22

¹Limited only by maximum temperature

²Repetitive avalanche causes additional power losses that can be calculated as $P_{AV} = E_{AR} \cdot f$.

³Device on 40mm*40mm*1.5mm epoxy PCB FR4 with 6cm² (one layer, 70 μm thick) copper area for drain connection. PCB is vertical without blown air.

⁵ $C_{o(er)}$ is a fixed capacitance that gives the same stored energy as C_{oss} while V_{DS} is rising from 0 to 80% V_{DSS} .

⁶ $C_{o(tr)}$ is a fixed capacitance that gives the same charging time as C_{oss} while V_{DS} is rising from 0 to 80% V_{DSS} .

⁷ $I_{SD} \leq I_D$, $di/dt \leq 400A/\mu s$, $V_{DClink} = 400V$, $V_{peak} < V_{BR, DSS}$, $T_j < T_{j,max}$.

Identical low-side and high-side switch.

Electrical Characteristics

Parameter	Symbol	Conditions	Values			Unit
			min.	typ.	max.	
Inverse diode continuous forward current	I_S	$T_C=25^\circ\text{C}$	-	-	20.7	A
Inverse diode direct current, pulsed	I_{SM}		-	-	62.1	
Inverse diode forward voltage	V_{SD}	$V_{GS}=0\text{V}, I_F=I_S$	-	1	1.2	V
Reverse recovery time	t_{rr}	$V_R=480\text{V}, I_F=I_S,$	-	500	800	ns
Reverse recovery charge	Q_{rr}	$di_F/dt=100\text{A}/\mu\text{s}$	-	11	-	μC
Peak reverse recovery current	I_{rrm}		-	70	-	A
Peak rate of fall of reverse recovery current	di_{rr}/dt	$T_j=25^\circ\text{C}$	-	1400	-	$\text{A}/\mu\text{s}$

Typical Transient Thermal Characteristics

Symbol	Value		Unit	Symbol	Value		Unit
	SPB				SPB		
R_{th1}	0.00769		K/W	C_{th1}	0.0003763		Ws/K
R_{th2}	0.015			C_{th2}	0.001411		
R_{th3}	0.029			C_{th3}	0.001931		
R_{th4}	0.114			C_{th4}	0.005297		
R_{th5}	0.136			C_{th5}	0.012		
R_{th6}	0.059			C_{th6}	0.091		

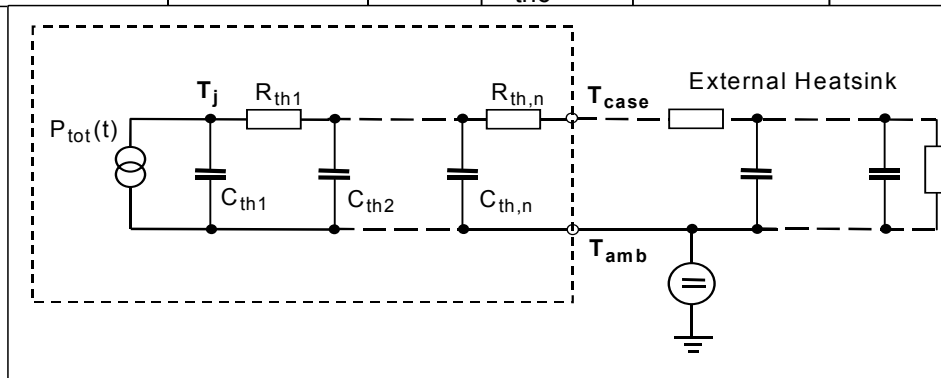

1 Power dissipation

$$P_{tot} = f(T_C)$$

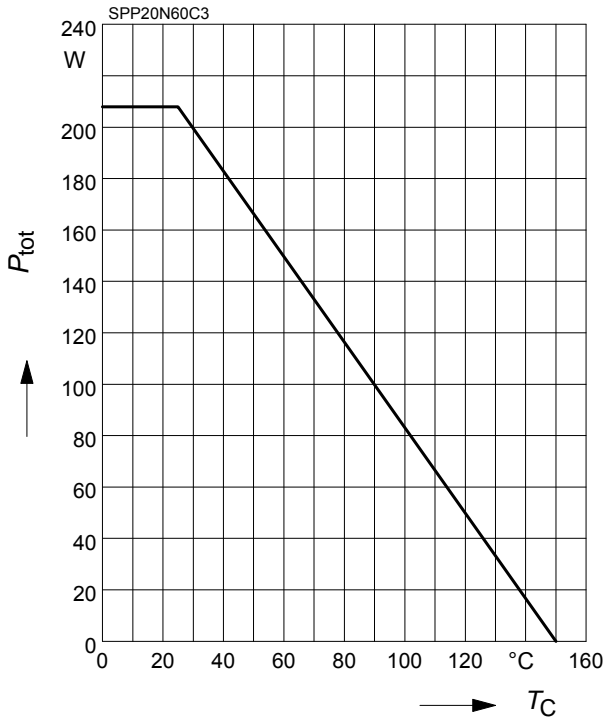

2 Transient thermal impedance

$$Z_{thJC} = f(t_p)$$

$$\text{parameter: } D = t_p/T$$

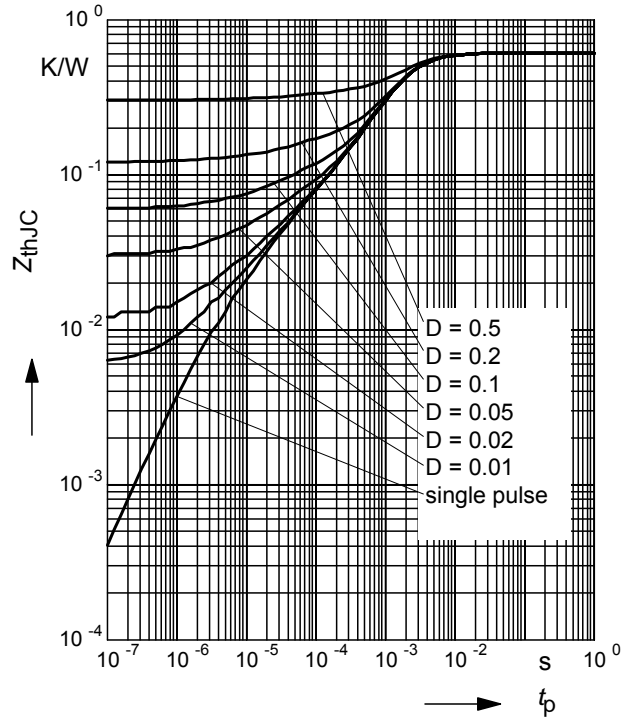

3 Safe operating area

$$I_D = f(V_{DS})$$

$$\text{parameter: } D = 0, T_C = 25^\circ\text{C}$$

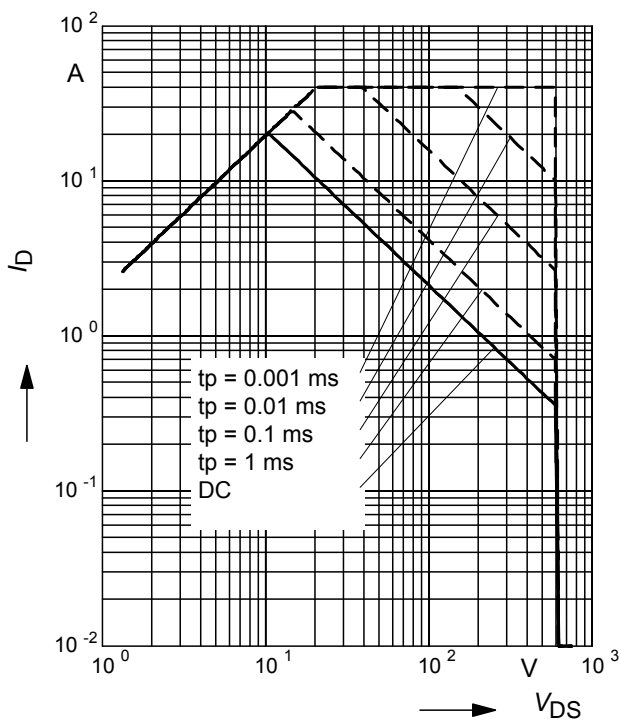

4 Typ. output characteristic

$$I_D = f(V_{DS}); T_j = 25^\circ\text{C}$$

$$\text{parameter: } t_p = 10 \mu\text{s}, V_{GS}$$

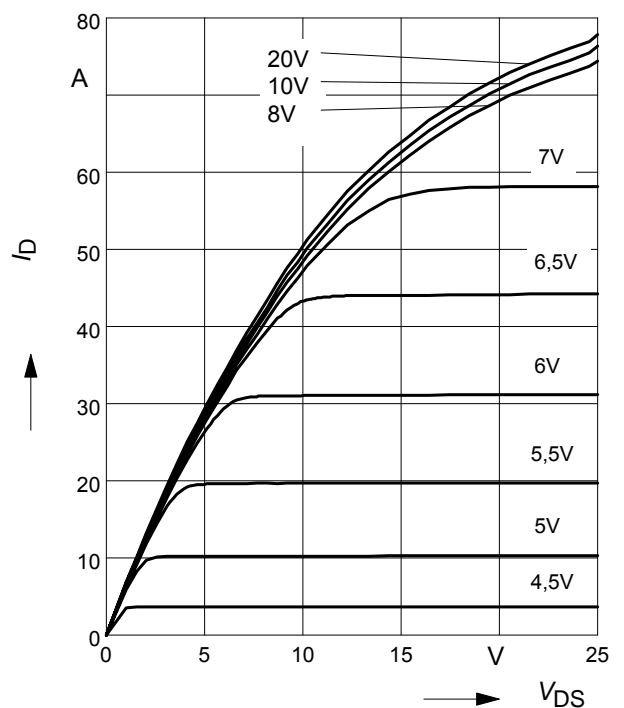

5 Typ. drain-source on resistance

$$R_{DS(on)} = f(I_D)$$

parameter: $T_j = 150^\circ\text{C}$, V_{GS}

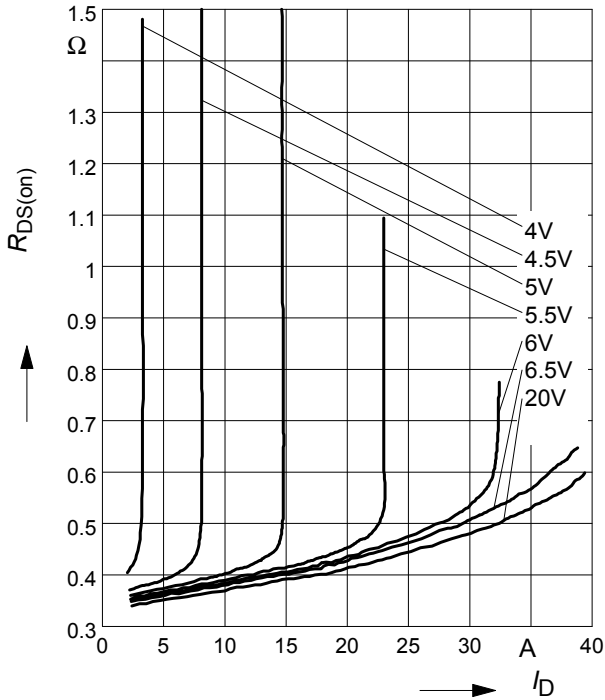

6 Typ. output characteristic

$$I_D = f(V_{DS}); T_j = 150^\circ\text{C}$$

parameter: $t_p = 10 \mu\text{s}$, V_{GS}

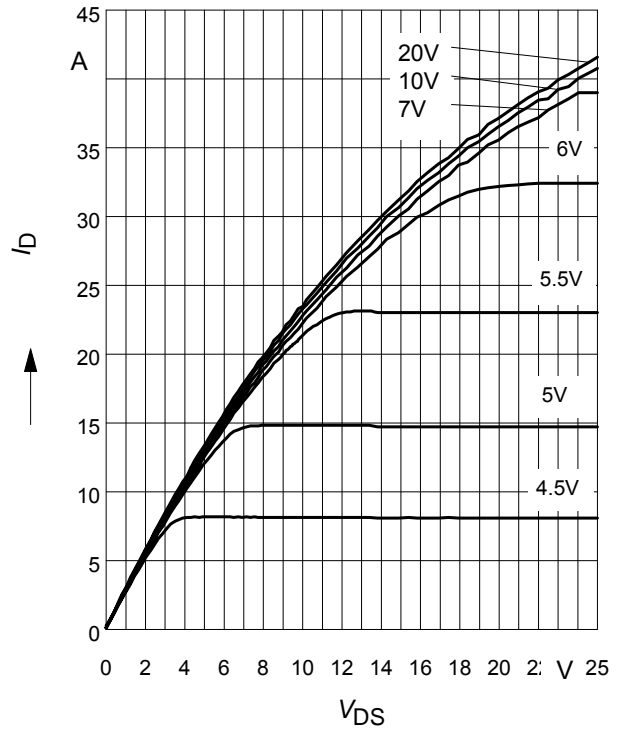

7 Drain-source on-state resistance

$$R_{DS(on)} = f(T_j)$$

parameter: $I_D = 13.1 \text{ A}$, $V_{GS} = 10 \text{ V}$

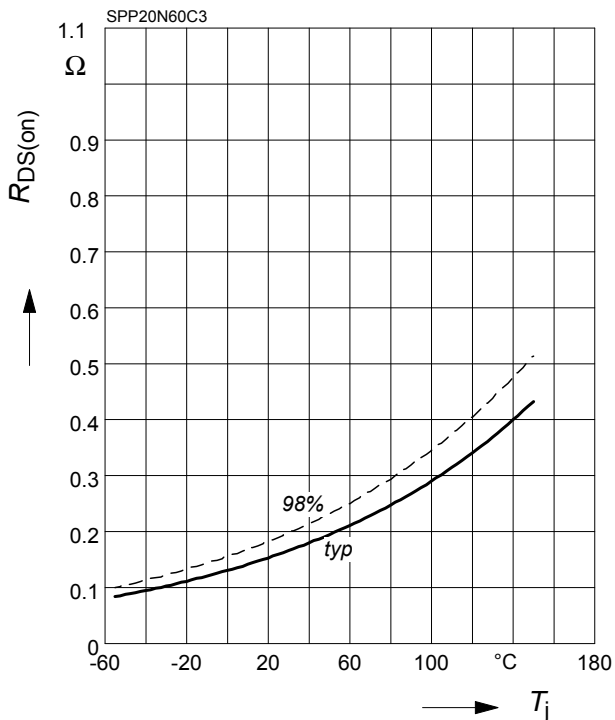

8 Typ. transfer characteristics

$$I_D = f(V_{GS}); V_{DS} \geq 2 \times I_D \times R_{DS(on)max}$$

parameter: $t_p = 10 \mu\text{s}$

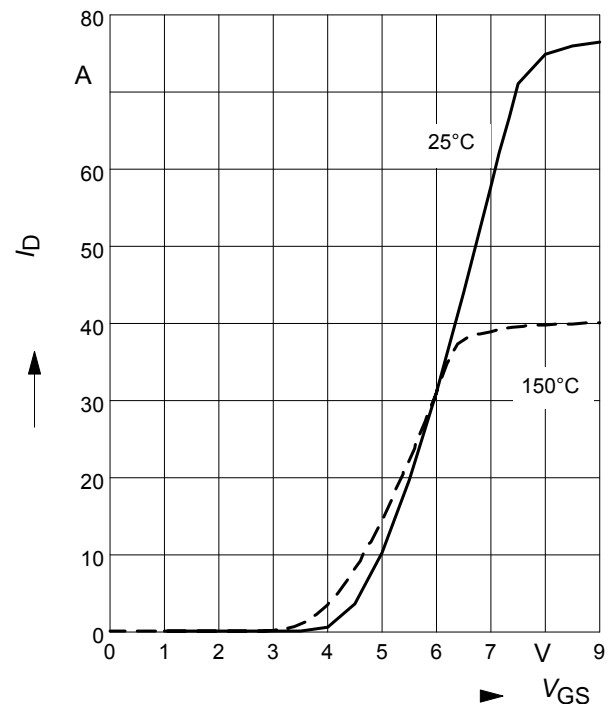

9 Typ. gate charge

$V_{GS} = f(Q_{Gate})$

parameter: $I_D = 20.7$ A pulsed

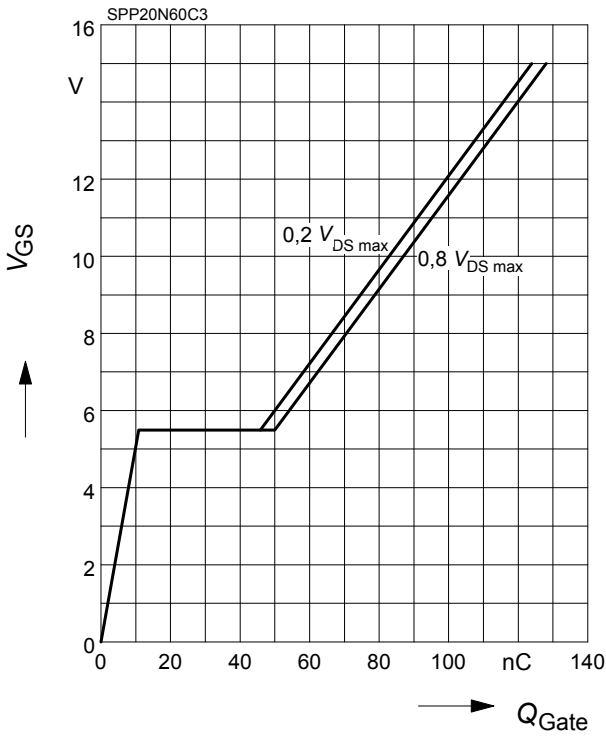

10 Typ. switching time

$t = f(R_G)$, inductive load, $T_j = 125^\circ\text{C}$

par.: $V_{DS} = 380\text{V}$, $V_{GS} = 0/+13\text{V}$, $I_D = 20.7$ A

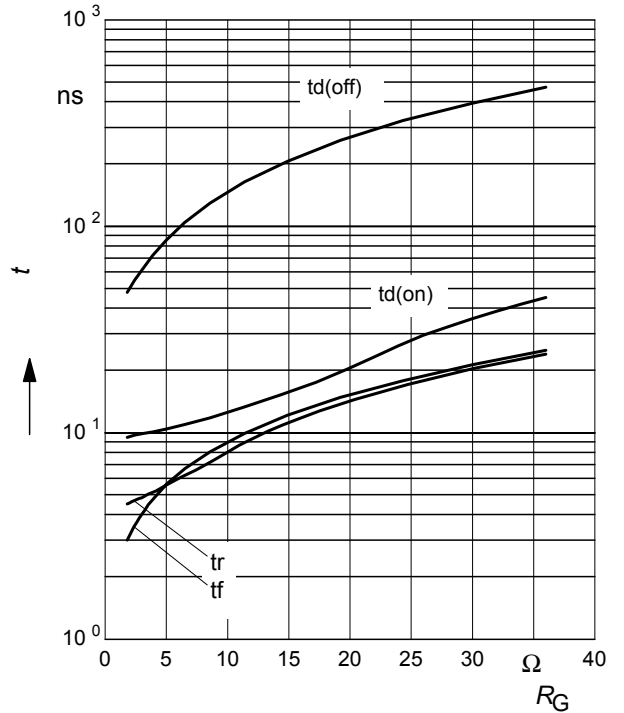

11 Typ. drain current slope

$di/dt = f(R_G)$, inductive load, $T_j = 125^\circ\text{C}$

par.: $V_{DS} = 380\text{V}$, $V_{GS} = 0/+13\text{V}$, $I_D = 20.7\text{A}$

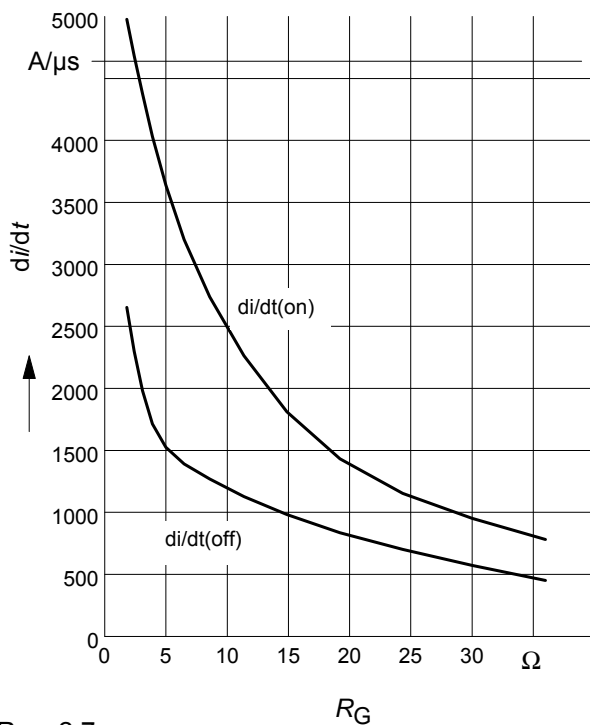

12 Drain-source breakdown voltage

$V_{(BR)DSS} = f(T_j)$

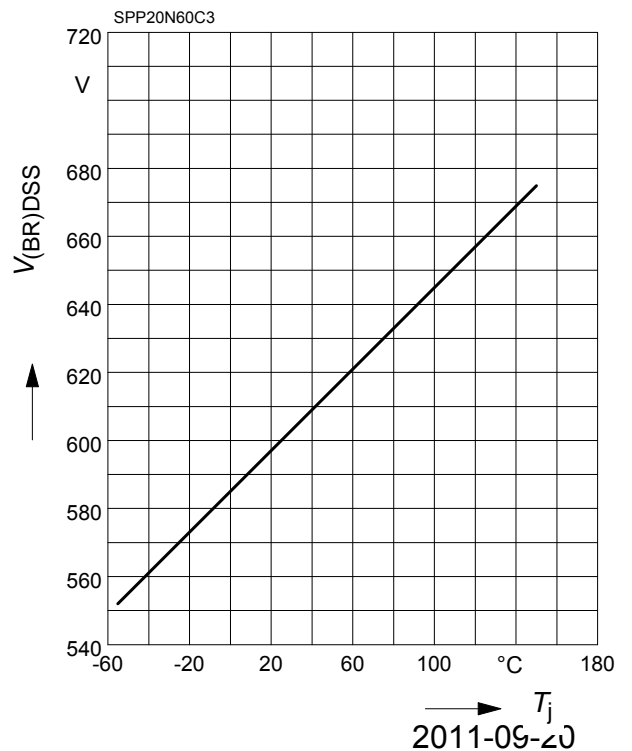

13 Forward characteristics of body diode

$I_F = f(V_{SD})$

parameter: $T_j, t_p = 10 \mu s$

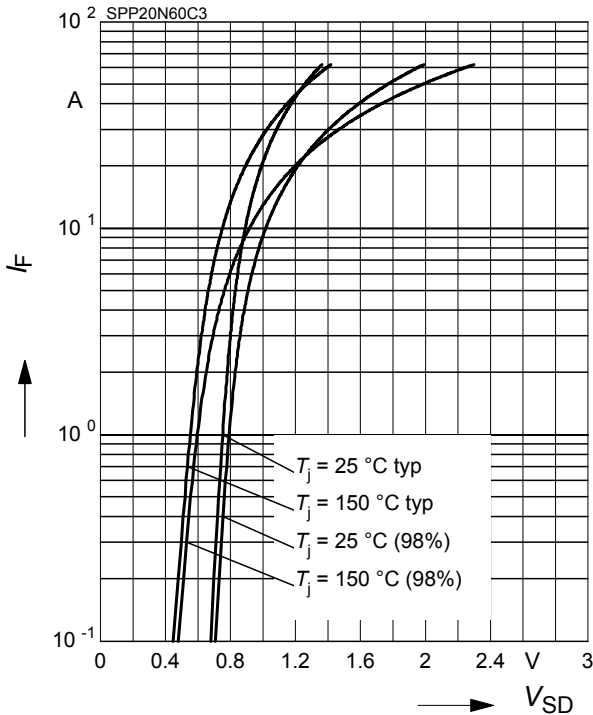

14 Typ. switching time

$t = f(I_D)$, inductive load, $T_j = 125^\circ C$

par.: $V_{DS} = 380V, V_{GS} = 0/+13V, R_G = 3.6\Omega$

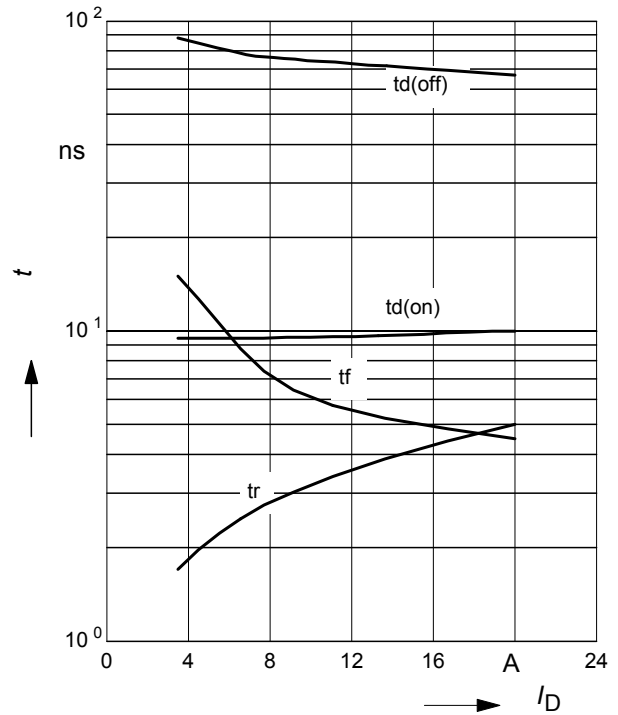

15 Avalanche power losses

$P_{AR} = f(f)$

parameter: $E_{AR} = 1mJ$

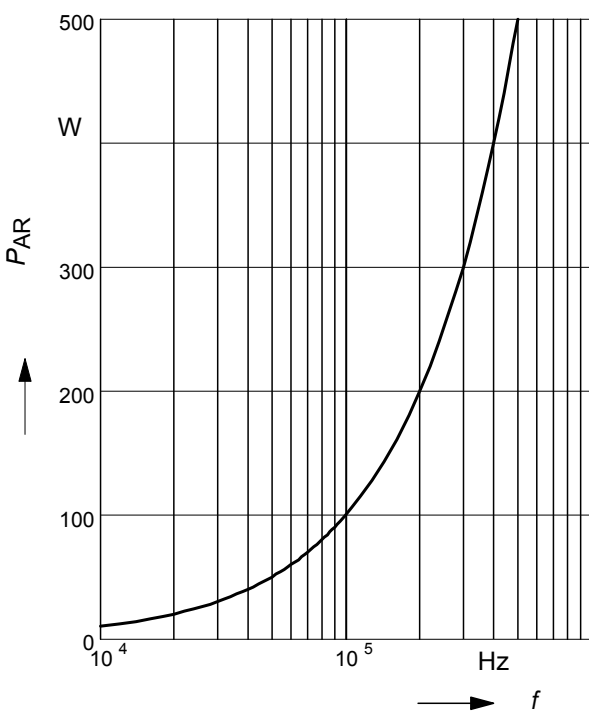

16 Typ. capacitances

$C = f(V_{DS})$

parameter: $V_{GS} = 0V, f = 1 MHz$

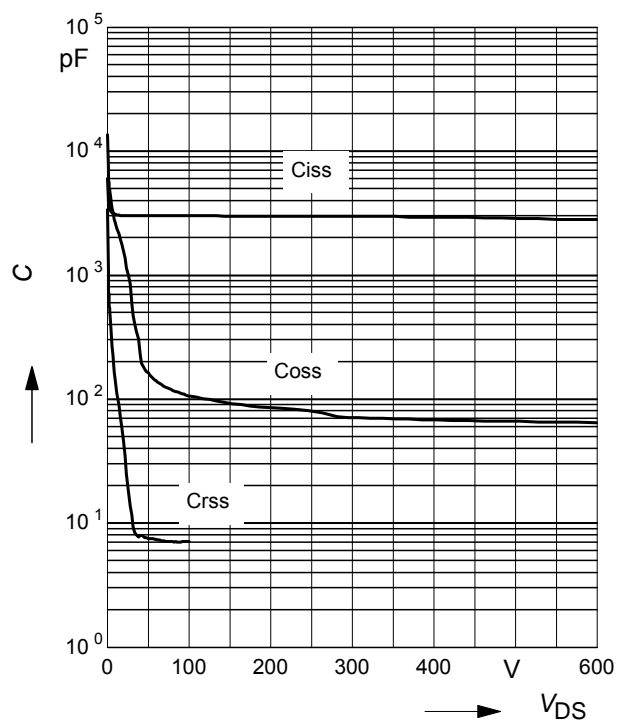

17 Typ. drain source voltage slope

$dv/dt = f(R_G)$, inductive load, $T_j = 125^\circ\text{C}$
 par.: $V_{DS}=380\text{V}$, $V_{GS}=0/+13\text{V}$, $I_D=20.7\text{A}$

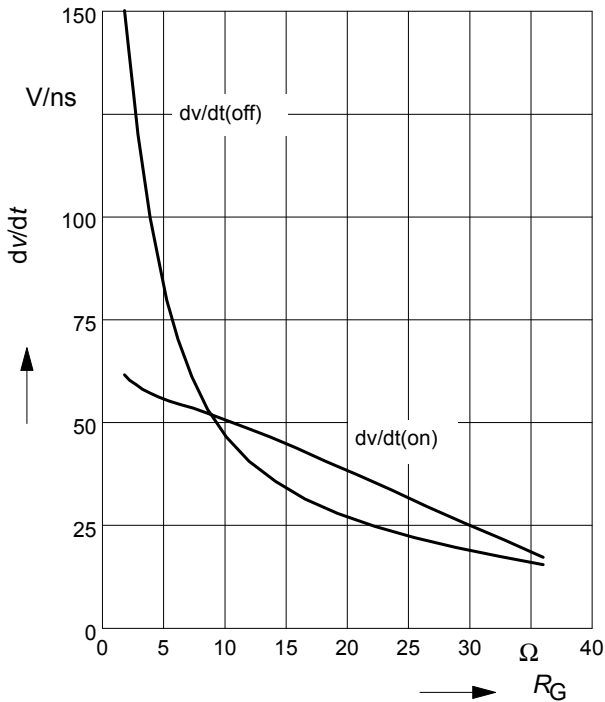

18 Typ. switching losses

$E = f(I_D)$, inductive load, $T_j=125^\circ\text{C}$
 par.: $V_{DS}=380\text{V}$, $V_{GS}=0/+13\text{V}$, $R_G=3.6\Omega$

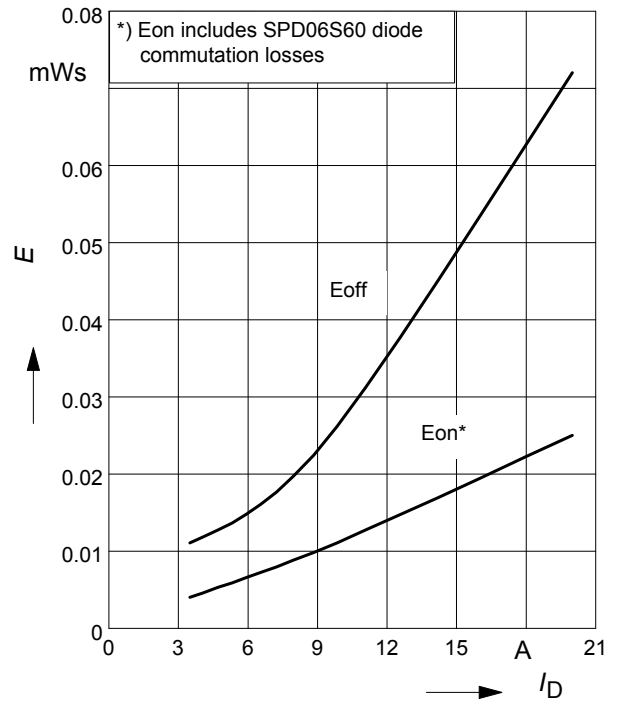

19 Typ. switching losses

$E = f(R_G)$, inductive load, $T_j=125^\circ\text{C}$
 par.: $V_{DS}=380\text{V}$, $V_{GS}=0/+13\text{V}$, $I_D=20.7\text{A}$

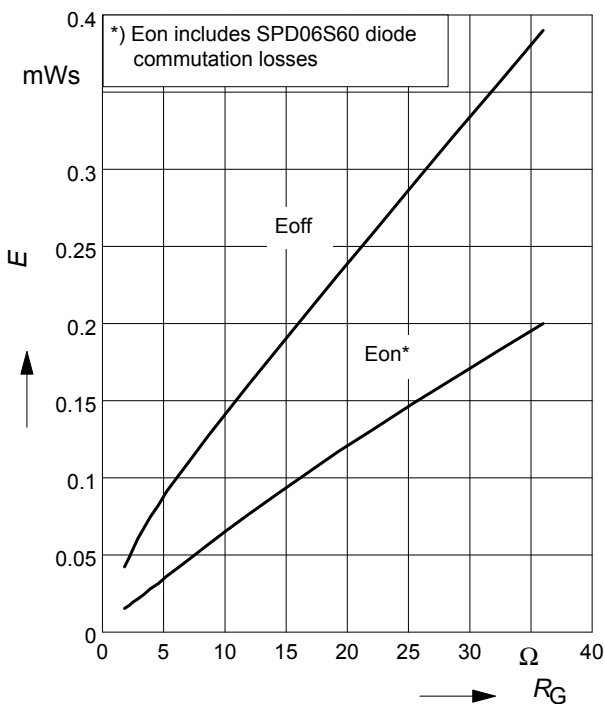

20 Avalanche SOA

$I_{AR} = f(t_{AR})$
 par.: $T_j \leq 150^\circ\text{C}$

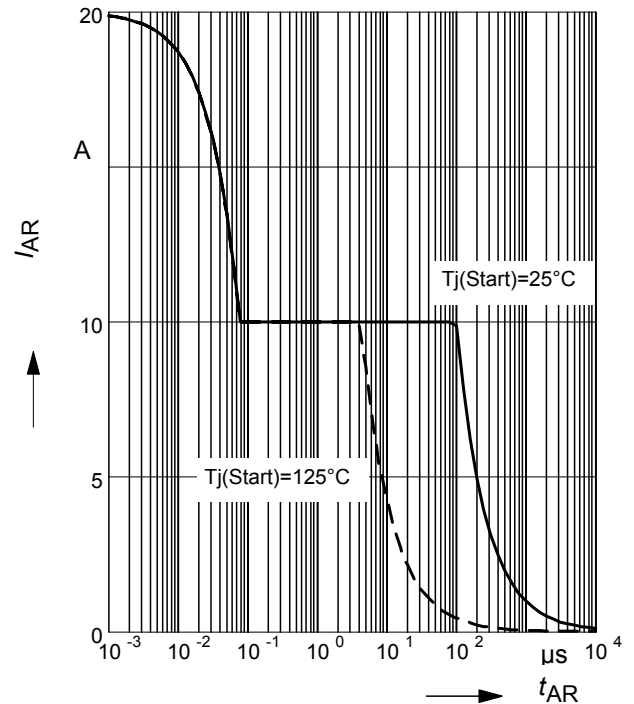

21 Avalanche energy

$$E_{AS} = f(T_j)$$

par.: $I_D = 10\text{ A}$, $V_{DD} = 50\text{ V}$

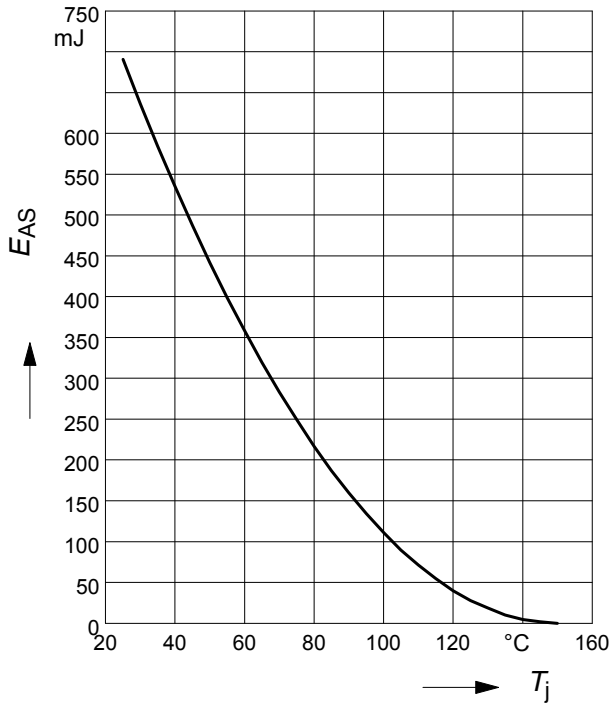

22 Typ. C_{OSS} stored energy

$$E_{OSS} = f(V_{DS})$$

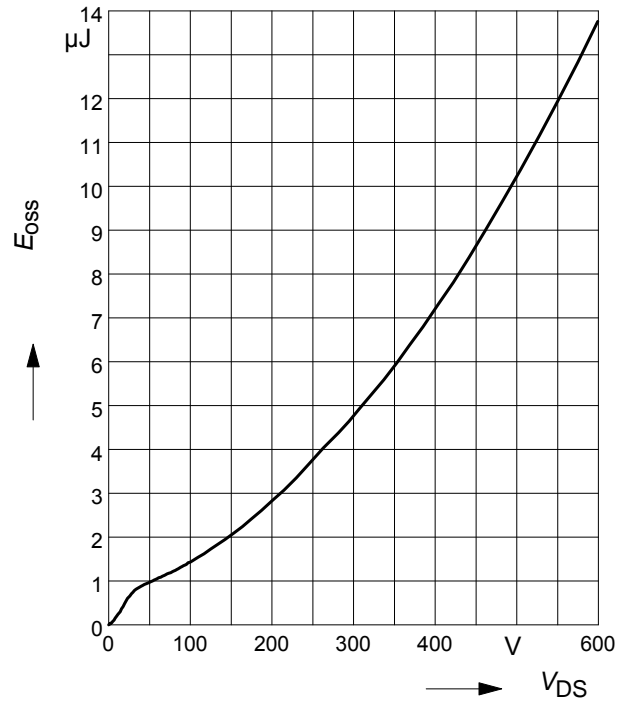

Definition of diodes switching characteristics

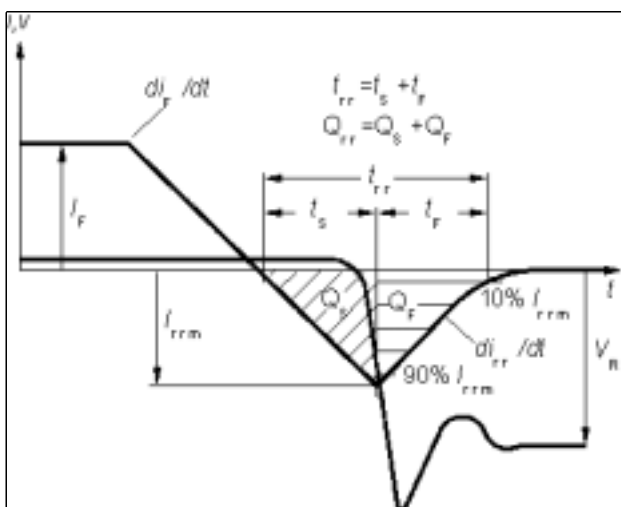

PG-TO263-3-2/ PG-TO263-3-5/ PG-TO263-3-22

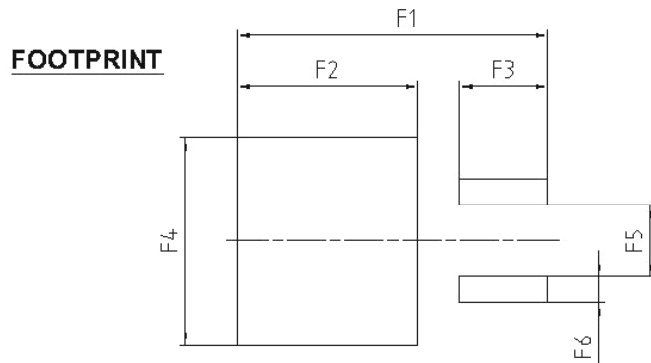
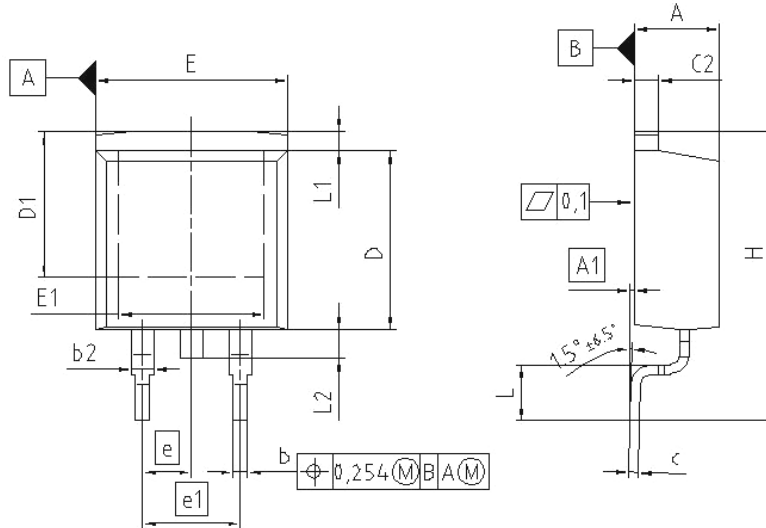

DIM	MILLIMETERS		INCHES	
	MIN	MAX	MIN	MAX
A	4.300	4.572	0.169	0.180
A1	0.000	0.254	0.000	0.010
b	0.650	0.850	0.026	0.033
b2	0.950	1.321	0.037	0.052
c	0.330	0.650	0.013	0.026
c2	0.170	1.400	0.046	0.055
D	8.509	9.450	0.335	0.372
D1	7.100	-	0.280	-
E	9.800	10.312	0.386	0.406
E1	6.500	-	0.256	-
e	2.540		0.100	
e1	5.080		0.200	
N	2		2	
H	14.605	15.875	0.575	0.625
L	2.200	3.000	0.087	0.118
L1	-	1.600	-	0.063
L2	1.000	1.778	0.039	0.070
F1	16.050	16.250	0.632	0.640
F2	9.300	9.500	0.366	0.374
F3	4.500	4.700	0.177	0.185
F4	10.700	10.900	0.421	0.429
F5	3.630	3.830	0.143	0.151
F6	1.100	1.300	0.043	0.051

REFERENCE
JEDEC TO263

SCALE

0 5 5 7.5mm

EUROPEAN PROJECTION

ISSUE DATE
12-02-2006

FILE
TO263_2

Published by
Infineon Technologies AG
81726 Munich, Germany
© 2009 Infineon Technologies AG
All Rights Reserved.

Legal Disclaimer

The information given in this document shall in no event be regarded as a guarantee of conditions or characteristics. With respect to any examples or hints given herein, any typical values stated herein and/or any information regarding the application of the device, Infineon Technologies hereby disclaims any and all warranties and liabilities of any kind, including without limitation, warranties of non-infringement of intellectual property rights of any third party.

Information

For further information on technology, delivery terms and conditions and prices, please contact the nearest Infineon Technologies Office (www.infineon.com).

Warnings

Due to technical requirements, components may contain dangerous substances. For information on the types in question, please contact the nearest Infineon Technologies Office. Infineon Technologies components may be used in life-support devices or systems only with the express written approval of Infineon Technologies, if a failure of such components can reasonably be expected to cause the failure of that life-support device or system or to affect the safety or effectiveness of that device or system. Life support devices or systems are intended to be implanted in the human body or to support and/or maintain and sustain and/or protect human life. If they fail, it is reasonable to assume that the health of the user or other persons may be endangered.

Mouser Electronics

Authorized Distributor

Click to View Pricing, Inventory, Delivery & Lifecycle Information:

[Infineon:](#)

[SPB20N60C3](#)