

Applications

- Brushed Motor drive applications
- BLDC Motor drive applications
- Battery powered circuits
- Half-bridge and full-bridge topologies
- Synchronous rectifier applications
- Resonant mode power supplies
- OR-ing and redundant power switches
- DC/DC and AC/DC converters
- DC/AC Inverters

Benefits

- Improved Gate, Avalanche and Dynamic dV/dt Ruggedness
- Fully Characterized Capacitance and Avalanche SOA
- Enhanced body diode dV/dt and dI/dt Capability
- Lead-Free
- Halogen-Free

HEXFET® Power MOSFET

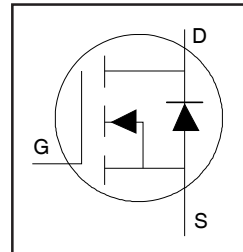

V_{DSS}	40V
R_{DS(on)} typ.	2.0mΩ
	max.
I_D	208A Ⓢ
I_D (Package Limited)	120A

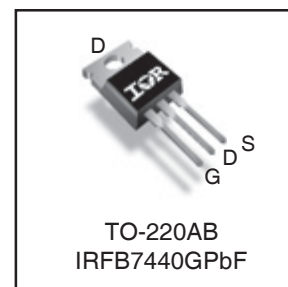

G	D	S
Gate	Drain	Source

Base Part Number	Package Type	Standard Pack		Complete Part Number
		Form	Quantity	
IRFB7440GPbF	TO-220	Tube	50	IRFB7440GPbF

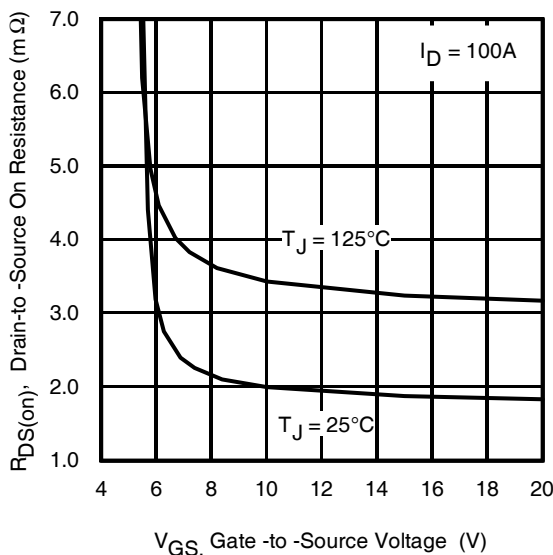

Fig 1. Typical On-Resistance vs. Gate Voltage

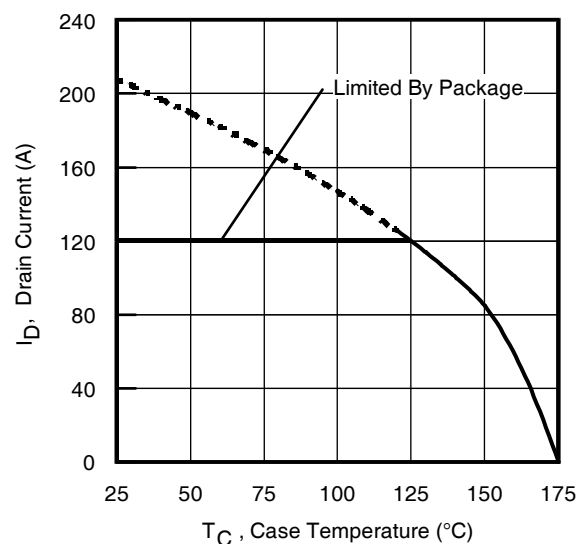

Fig 2. Maximum Drain Current vs. Case Temperature

Absolute Maximum Ratings

Symbol	Parameter	Max.	Units
$I_D @ T_C = 25^\circ\text{C}$	Continuous Drain Current, $V_{GS} @ 10\text{V}$	208 ^①	A
$I_D @ T_C = 100^\circ\text{C}$	Continuous Drain Current, $V_{GS} @ 10\text{V}$	147 ^①	
$I_D @ T_C = 25^\circ\text{C}$	Continuous Drain Current, $V_{GS} @ 10\text{V}$ (Wire Bond Limited)	120	
I_{DM}	Pulsed Drain Current ^②	772	
$P_D @ T_C = 25^\circ\text{C}$	Maximum Power Dissipation	208	W
	Linear Derating Factor	1.4	W/°C
V_{GS}	Gate-to-Source Voltage	± 20	V
T_J	Operating Junction and	-55 to + 175	°C
T_{STG}	Storage Temperature Range		
	Soldering Temperature, for 10 seconds (1.6mm from case)		
	Mounting torque, 6-32 or M3 screw	10lbf·in (1.1N·m)	

Avalanche Characteristics

E_{AS} (Thermally limited)	Single Pulse Avalanche Energy ^③	238	mJ
E_{AS} (Thermally limited)	Single Pulse Avalanche Energy ^④	560	
I_{AR}	Avalanche Current ^②	See Fig. 14, 15, 22a, 22b	A
E_{AR}	Repetitive Avalanche Energy ^②		mJ

Thermal Resistance

Symbol	Parameter	Typ.	Max.	Units
$R_{\theta JC}$	Junction-to-Case ^⑧	—	0.72	°C/W
$R_{\theta CS}$	Case-to-Sink, Flat Greased Surface	0.50	—	
$R_{\theta JA}$	Junction-to-Ambient	—	62	

Static @ $T_J = 25^\circ\text{C}$ (unless otherwise specified)

Symbol	Parameter	Min.	Typ.	Max.	Units	Conditions
$V_{(BR)DSS}$	Drain-to-Source Breakdown Voltage	40	—	—	V	$V_{GS} = 0\text{V}$, $I_D = 250\mu\text{A}$
$\Delta V_{(BR)DSS}/\Delta T_J$	Breakdown Voltage Temp. Coefficient	—	0.035	—	V/°C	Reference to 25°C , $I_D = 5.0\text{mA}$ ^②
$R_{DS(on)}$	Static Drain-to-Source On-Resistance	—	2.0	2.5	mΩ	$V_{GS} = 10\text{V}$, $I_D = 100\text{A}$ ^⑤
		—	3.0	—	mΩ	$V_{GS} = 6.0\text{V}$, $I_D = 50\text{A}$ ^⑤
$V_{GS(th)}$	Gate Threshold Voltage	2.2	3.0	3.9	V	$V_{DS} = V_{GS}$, $I_D = 100\mu\text{A}$
I_{DSS}	Drain-to-Source Leakage Current	—	—	1.0	μA	$V_{DS} = 40\text{V}$, $V_{GS} = 0\text{V}$
		—	—	150		$V_{DS} = 40\text{V}$, $V_{GS} = 0\text{V}$, $T_J = 125^\circ\text{C}$
I_{GSS}	Gate-to-Source Forward Leakage	—	—	100	nA	$V_{GS} = 20\text{V}$
	Gate-to-Source Reverse Leakage	—	—	-100		$V_{GS} = -20\text{V}$
R_G	Internal Gate Resistance	—	2.6	—	Ω	

Notes:

- ① Calculated continuous current based on maximum allowable junction temperature. Bond wire current limit is 120A. Note that current limitations arising from heating of the device leads may occur with some lead mounting arrangements. (Refer to AN-1140)
- ② Repetitive rating; pulse width limited by max. junction temperature.
- ③ Limited by T_{Jmax} , starting $T_J = 25^\circ\text{C}$, $L = 0.048\text{mH}$, $R_G = 50\Omega$, $I_{AS} = 100\text{A}$, $V_{GS} = 10\text{V}$.
- ④ $I_{SD} \leq 100\text{A}$, $di/dt \leq 1330\text{A}/\mu\text{s}$, $V_{DD} \leq V_{(BR)DSS}$, $T_J \leq 175^\circ\text{C}$.
- ⑤ Pulse width $\leq 400\mu\text{s}$; duty cycle $\leq 2\%$.
- ⑥ C_{oss} eff. (TR) is a fixed capacitance that gives the same charging time as C_{oss} while V_{DS} is rising from 0 to 80% V_{DSS} .
- ⑦ C_{oss} eff. (ER) is a fixed capacitance that gives the same energy as C_{oss} while V_{DS} is rising from 0 to 80% V_{DSS} .
- ⑧ R_{θ} is measured at T_J approximately 90°C .
- ⑨ Limited by T_{Jmax} starting $T_J = 25^\circ\text{C}$, $L = 1\text{mH}$, $R_G = 50\Omega$, $I_{AS} = 34\text{A}$, $V_{GS} = 10\text{V}$.

Dynamic @ T_J = 25°C (unless otherwise specified)

Symbol	Parameter	Min.	Typ.	Max.	Units	Conditions
g _{fs}	Forward Transconductance	88	—	—	S	V _{DS} = 10V, I _D = 100A
Q _g	Total Gate Charge	—	90	135	nC	I _D = 100A
Q _{gs}	Gate-to-Source Charge	—	23	—		V _{DS} = 20V
Q _{gd}	Gate-to-Drain ("Miller") Charge	—	32	—		V _{GS} = 10V ⑤
Q _{sync}	Total Gate Charge Sync. (Q _g - Q _{gd})	—	58	—		I _D = 100A, V _{DS} = 0V, V _{GS} = 10V
t _{d(on)}	Turn-On Delay Time	—	24	—		ns
t _r	Rise Time	—	68	—	I _D = 30A	
t _{d(off)}	Turn-Off Delay Time	—	115	—	R _G = 2.7Ω	
t _f	Fall Time	—	68	—	V _{GS} = 10V ⑤	
C _{iss}	Input Capacitance	—	4730	—	pF	V _{GS} = 0V
C _{oss}	Output Capacitance	—	680	—		V _{DS} = 25V
C _{rss}	Reverse Transfer Capacitance	—	460	—		f = 1.0 MHz
C _{oss} eff. (ER)	Effective Output Capacitance (Energy Related)	—	845	—		V _{GS} = 0V, V _{DS} = 0V to 32V ⑦
C _{oss} eff. (TR)	Effective Output Capacitance (Time Related)	—	980	—		V _{GS} = 0V, V _{DS} = 0V to 32V ⑧

Diode Characteristics

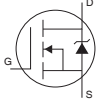
Symbol	Parameter	Min.	Typ.	Max.	Units	Conditions
I _S	Continuous Source Current (Body Diode)	—	—	208①	A	MOSFET symbol showing the integral reverse p-n junction diode. 
I _{SM}	Pulsed Source Current (Body Diode) ②	—	—	772	A	
V _{SD}	Diode Forward Voltage	—	0.9	1.3	V	T _J = 25°C, I _S = 100A, V _{GS} = 0V ③
dv/dt	Peak Diode Recovery ④	—	6.8	—	V/ns	T _J = 175°C, I _S = 100A, V _{DS} = 40V
t _{rr}	Reverse Recovery Time	—	24	—	ns	T _J = 25°C
		—	28	—		T _J = 125°C
Q _{rr}	Reverse Recovery Charge	—	17	—	nC	T _J = 25°C
		—	20	—		T _J = 125°C
I _{RRM}	Reverse Recovery Current	—	1.3	—	A	T _J = 25°C

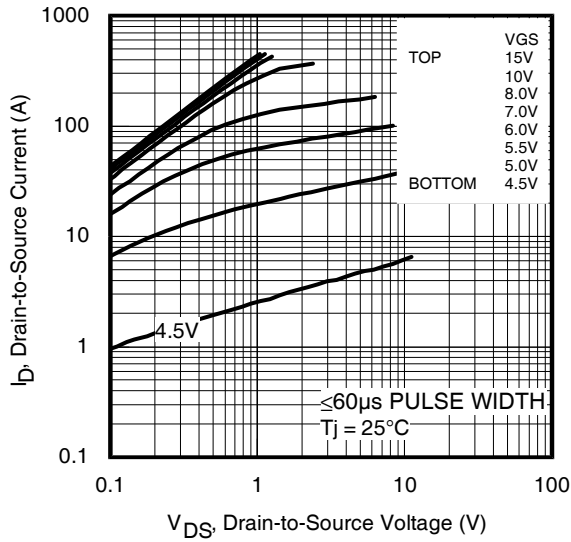
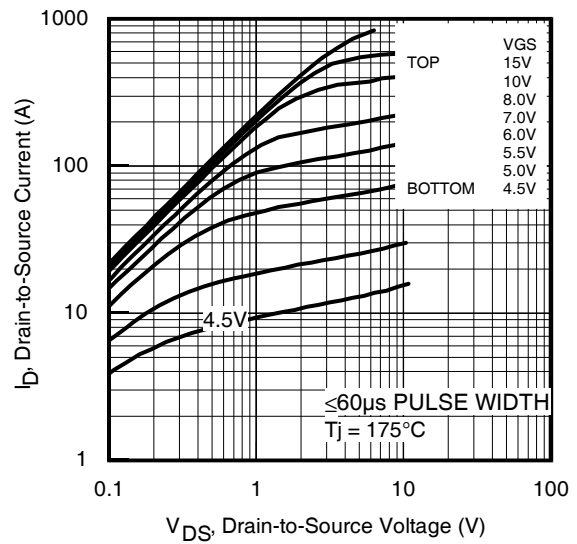
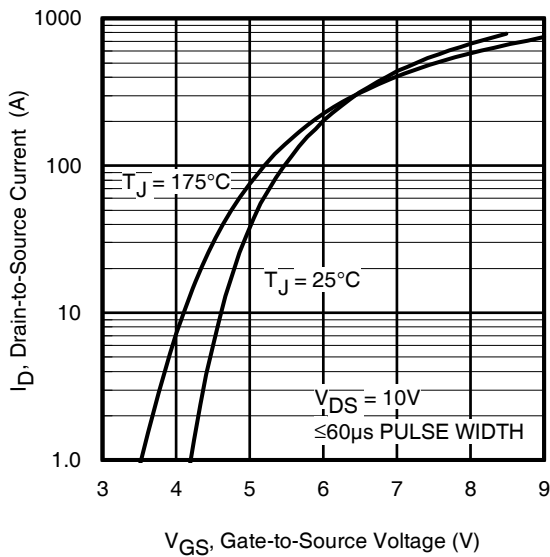
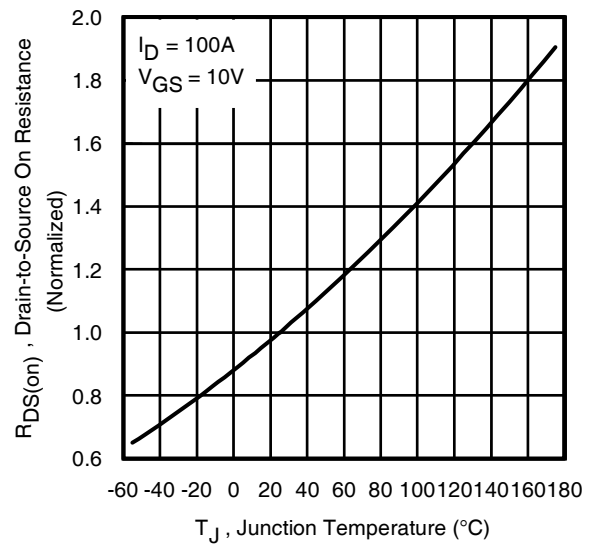
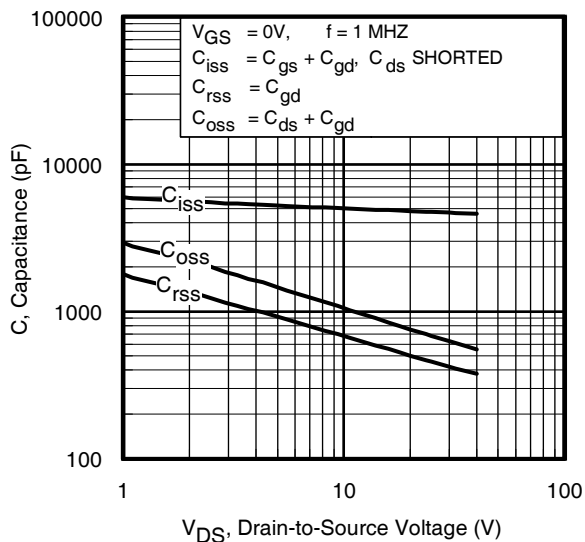
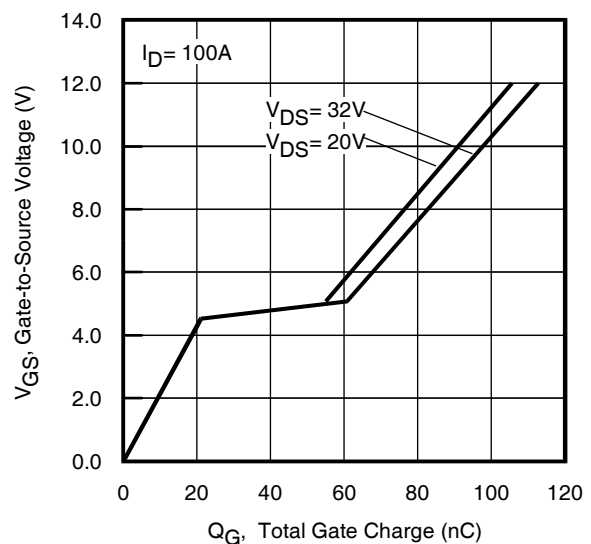
Fig 3. Typical Output Characteristics

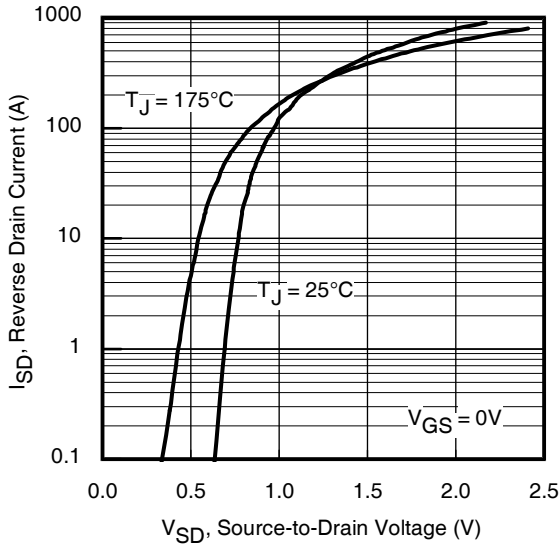
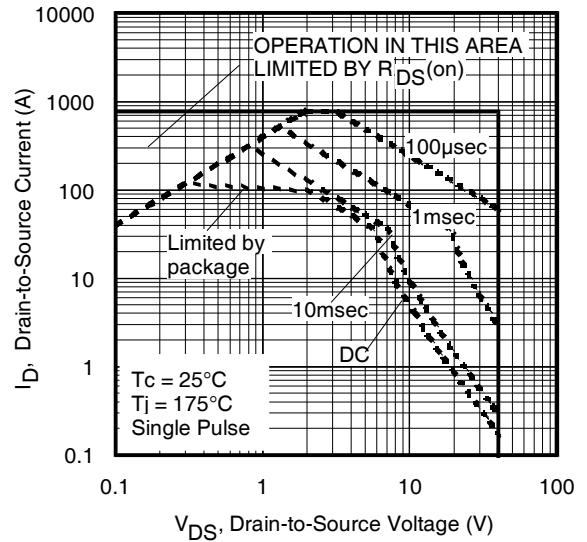
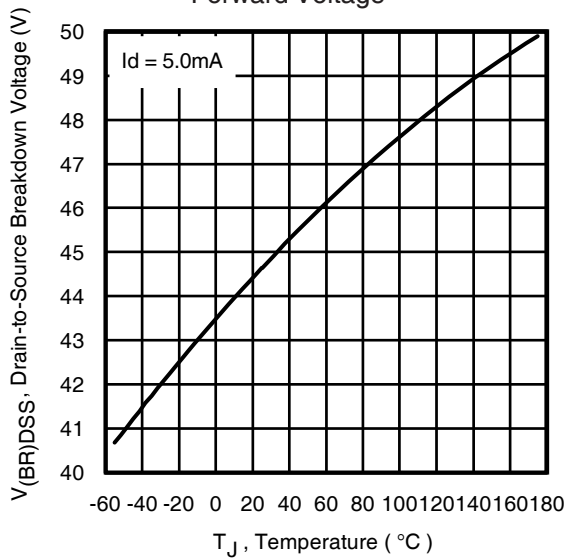
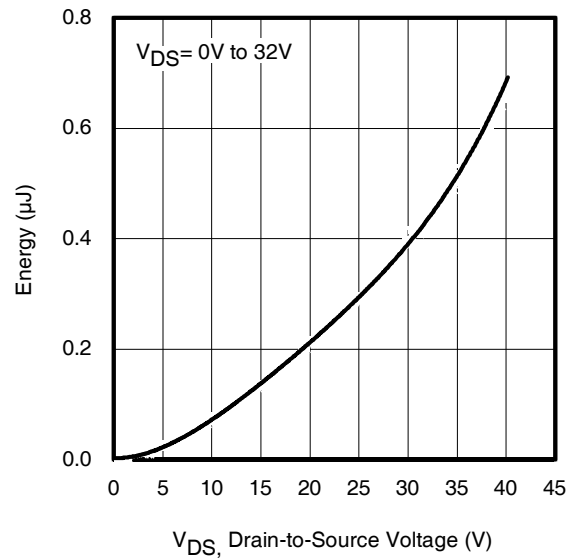
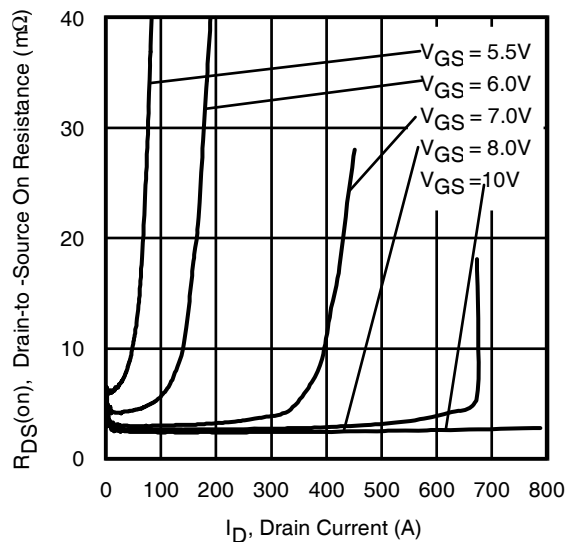
Fig 4. Typical Output Characteristics

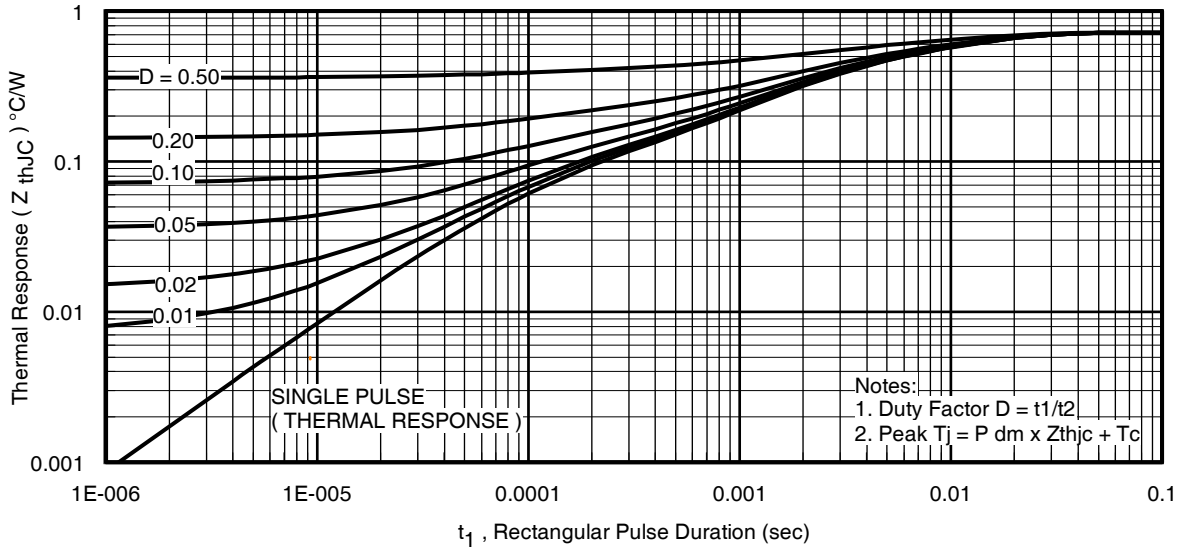
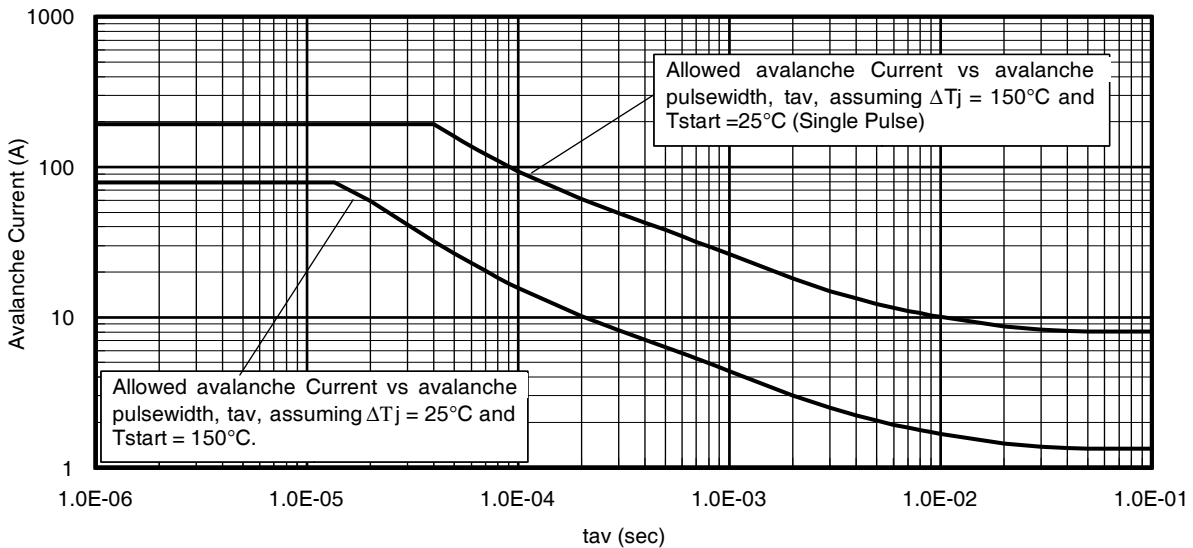
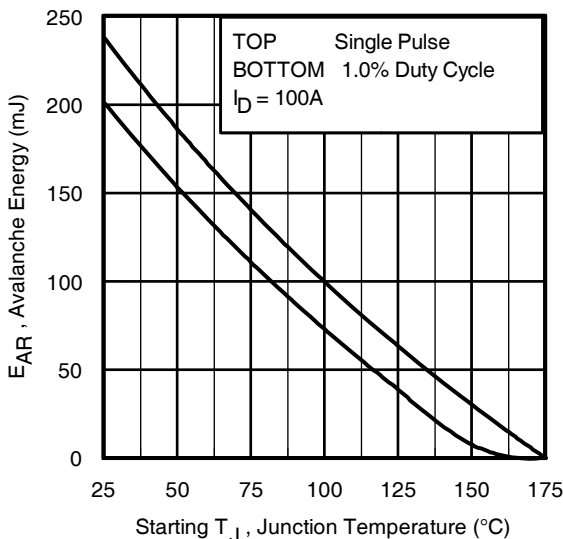
Fig 5. Typical Transfer Characteristics

Fig 6. Normalized On-Resistance vs. Temperature

Fig 7. Typical Capacitance vs. Drain-to-Source Voltage

Fig 8. Typical Gate Charge vs. Gate-to-Source Voltage

Fig 9. Typical Source-Drain Diode Forward Voltage

Fig 10. Maximum Safe Operating Area

Fig 11. Drain-to-Source Breakdown Voltage

Fig 12. Typical C_{OSS} Stored Energy

Fig 13. Typical On-Resistance vs. Drain Current

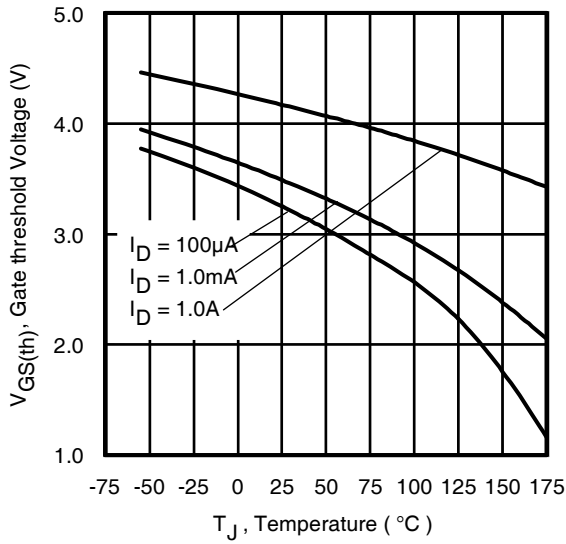
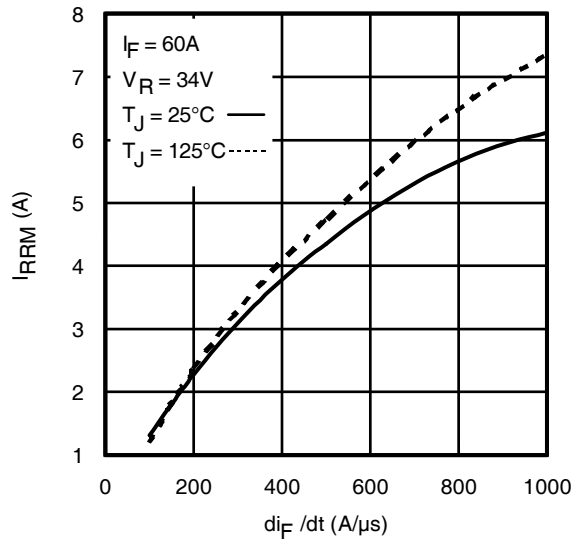
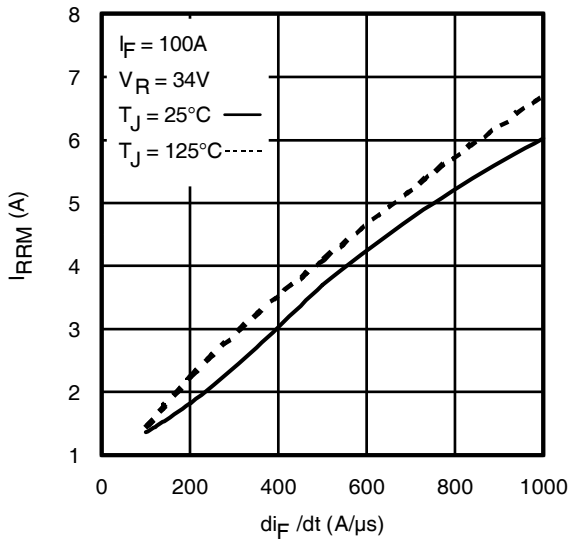
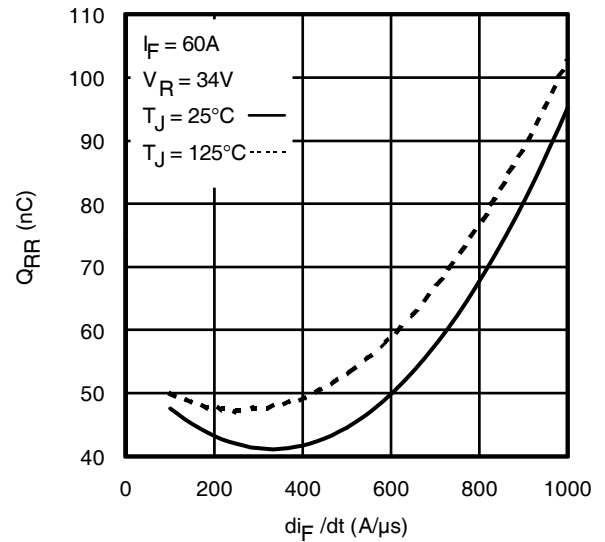
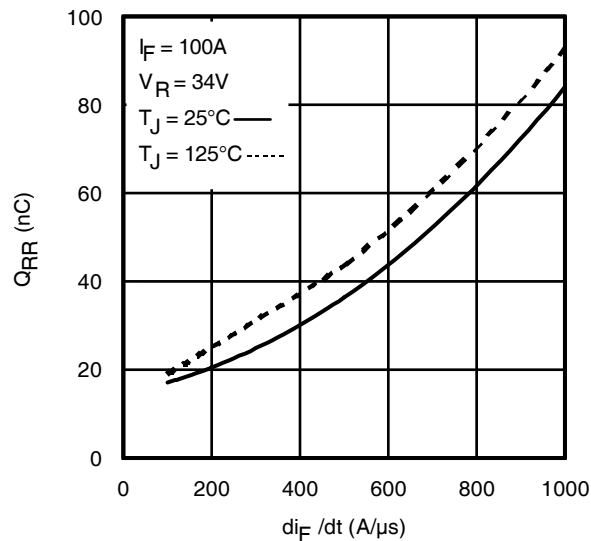

Fig 14. Maximum Effective Transient Thermal Impedance, Junction-to-Case

Fig 15. Typical Avalanche Current vs. Pulsewidth

Fig 16. Maximum Avalanche Energy vs. Temperature
**Notes on Repetitive Avalanche Curves , Figures 14, 15:
(For further info, see AN-1005 at www.irf.com)**

1. Avalanche failures assumption:
Purely a thermal phenomenon and failure occurs at a temperature far in excess of T_{jmax} . This is validated for every part type.
2. Safe operation in Avalanche is allowed as long as T_{jmax} is not exceeded.
3. Equation below based on circuit and waveforms shown in Figures 16a, 16b.
4. $P_{D(ave)}$ = Average power dissipation per single avalanche pulse.
5. BV = Rated breakdown voltage (1.3 factor accounts for voltage increase during avalanche).
6. I_{av} = Allowable avalanche current.
7. ΔT = Allowable rise in junction temperature, not to exceed T_{jmax} (assumed as 25°C in Figure 14, 15).
 t_{av} = Average time in avalanche.
 D = Duty cycle in avalanche = $t_{av} \cdot f$
 $Z_{thJC}(D, t_{av})$ = Transient thermal resistance, see Figures 13)

$$P_{D(ave)} = 1/2 (1.3 \cdot BV \cdot I_{av}) = \Delta T / Z_{thJC}$$

$$I_{av} = 2\Delta T / [1.3 \cdot BV \cdot Z_{th}]$$

$$E_{AS(AR)} = P_{D(ave)} \cdot t_{av}$$

Fig 17. Threshold Voltage vs. Temperature

Fig. 18 - Typical Recovery Current vs. di_f/dt

Fig. 19 - Typical Recovery Current vs. di_f/dt

Fig. 20 - Typical Stored Charge vs. di_f/dt

Fig. 21 - Typical Stored Charge vs. di_f/dt



* $V_{GS} = 5V$ for Logic Level Devices

Fig 22. Peak Diode Recovery dv/dt Test Circuit for N-Channel HEXFET® Power MOSFETs



Fig 22a. Unclamped Inductive Test Circuit



Fig 22b. Unclamped Inductive Waveforms



Fig 23a. Switching Time Test Circuit

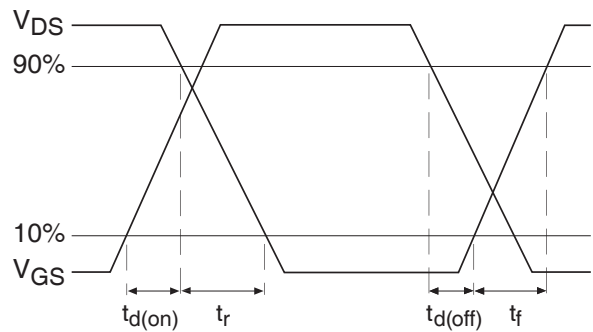

Fig 23b. Switching Time Waveforms



Fig 24a. Gate Charge Test Circuit



Fig 24b. Gate Charge Waveform

TO-220AB Package Outline

Dimensions are shown in millimeters (inches)

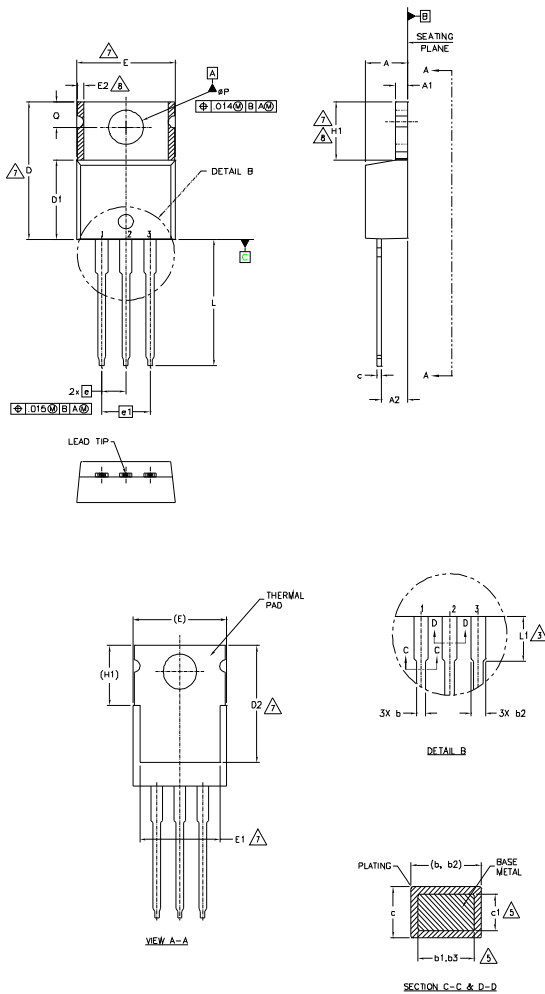

NOTES:

- 1.- DIMENSIONING AND TOLERANCING AS PER ASME Y14.5 M- 1994.
- 2.- DIMENSIONS ARE SHOWN IN INCHES [MILLIMETERS]
- 3.- LEAD DIMENSION AND FINISH UNCONTROLLED IN L1.
- 4.- DIMENSION D, D1 & E DO NOT INCLUDE MOLD FLASH. MOLD FLASH SHALL NOT EXCEED .005" (0.127) PER SIDE. THESE DIMENSIONS ARE MEASURED AT THE OUTERMOST EXTREMES OF THE PLASTIC BODY.
- 5.- DIMENSION b1, b3 & c1 APPLY TO BASE METAL ONLY.
- 6.- CONTROLLING DIMENSION : INCHES.
- 7.- THERMAL PAD CONTOUR OPTIONAL WITHIN DIMENSIONS E,H1,D2 & E1
- 8.- DIMENSION E2 x H1 DEFINE A ZONE WHERE STAMPING AND SINGULATION IRREGULARITIES ARE ALLOWED.
- 9.- OUTLINE CONFORMS TO JEDEC TO-220, EXCEPT A2 (max.) AND D2 (min.) WHERE DIMENSIONS ARE DERIVED FROM THE ACTUAL PACKAGE OUTLINE.

SYMBOL	DIMENSIONS				NOTES
	MILLIMETERS		INCHES		
	MIN.	MAX.	MIN.	MAX.	
A	3.56	4.83	.140	.190	
A1	1.14	1.40	.045	.055	
A2	2.03	2.92	.080	.115	
b	0.38	1.01	.015	.040	
b1	0.38	0.97	.015	.038	5
b2	1.14	1.78	.045	.070	
b3	1.14	1.73	.045	.068	5
c	0.36	0.61	.014	.024	
c1	0.36	0.56	.014	.022	5
D	14.22	16.51	.560	.650	4
D1	8.38	9.02	.330	.355	
D2	11.68	12.88	.460	.507	7
E	9.65	10.67	.380	.420	4,7
E1	6.86	8.89	.270	.350	7
E2	-	0.76	-	.030	8
e	2.54 BSC		.100 BSC		
e1	5.08 BSC		.200 BSC		
H1	5.84	6.86	.230	.270	7,8
L	12.70	14.73	.500	.580	
L1	3.56	4.06	.140	.160	3
øP	3.54	4.08	.139	.161	
Q	2.54	3.42	.100	.135	

LEAD ASSIGNMENTS

HEXFET

- 1.- GATE
- 2.- DRAIN
- 3.- SOURCE

IGBTs, CoPACK

- 1.- GATE
- 2.- COLLECTOR
- 3.- EMITTER

DIODES

- 1.- ANODE
- 2.- CATHODE
- 3.- ANODE

TO-220AB Part Marking Information

EXAMPLE: THIS IS AN IRFB4310GPBF

Note: "G" suffix in part number indicates "Halogen - Free"

Note: "P" in assembly line position indicates "Lead - Free"

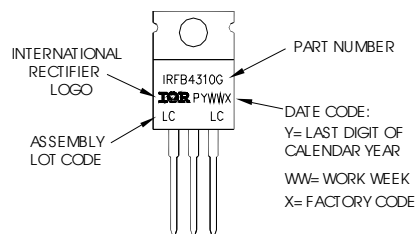

TO-220AB packages are not recommended for Surface Mount Application.

Note: For the most current drawing please refer to IR website at <http://www.irf.com/package/>

Qualification information[†]

Qualification level	Industrial (per JEDEC JESD47F ^{††} guidelines)	
Moisture Sensitivity Level	TO-220	Not applicable
RoHS compliant	Yes	

† Qualification standards can be found at International Rectifier's web site: <http://www.irf.com/product-info/reliability/>

†† Applicable version of JEDEC standard at the time of product release.

Revision History

Date	Comment
11/19/2014	<ul style="list-style-type: none"> • Updated data sheet with IR corporate template. • Updated $E_{AS(L=1mH)} = 560mJ$ on page 2 • Updated note 9 "Limited by T_{Jmax}, starting $T_J = 25^{\circ}C$, $L = 1mH$, $R_G = 50\Omega$, $I_{AS} = 34A$, $V_{GS} = 10V$". on page 2 • Updated package outline on page 9.

Mouser Electronics

Authorized Distributor

Click to View Pricing, Inventory, Delivery & Lifecycle Information:

[International Rectifier:](#)

[IRFB7440GPBF](#)