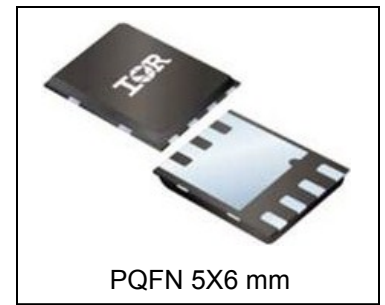
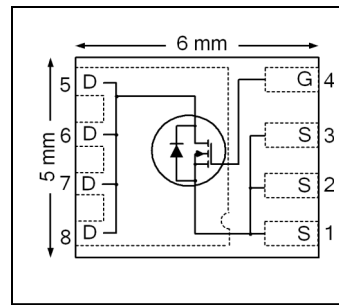


HEXFET® Power MOSFET

<b>V<sub>DSS</sub></b>	<b>100</b>	<b>V</b>
<b>R<sub>DS(on)</sub> max</b> (@ V <sub>GS</sub> = 10V)	<b>16.4</b>	<b>mΩ</b>
<b>Q<sub>g</sub> (typical)</b>	<b>13</b>	<b>nC</b>
<b>R<sub>g</sub> (typical)</b>	<b>2.1</b>	<b>Ω</b>
<b>I<sub>D</sub></b> (@T <sub>C(Bottom)</sub> = 25°C)	<b>35</b>	<b>A</b>



### Applications

- Primary Switch for High Frequency 48V/60V Telecom DC-DC Power Supplies
- Secondary Side Synchronous Rectifier

### Features

Low R <sub>DS(ON)</sub> (< 16.4mΩ)
Low Thermal Resistance to PCB (<3.2°C/W)
100% R <sub>g</sub> Tested
Low Profile (<1.05 mm)
Industry-Standard Pinout
Compatible with Existing Surface Mount Techniques
RoHS Compliant, Halogen-Free
MSL1

results in  
⇒

### Benefits

Lower Conduction Losses
Increased Power Density
Increased Reliability
Increased Power Density
Multi-Vendor Compatibility
Easier Manufacturing
Environmentally Friendlier
Increased Reliability

Base part number	Package Type	Standard Pack		Orderable Part Number
		Form	Quantity	
IRFH7194PbF	PQFN 5mm x 6 mm	Tape and Reel	4000	IRFH7194TRPbF

### Absolute Maximum Ratings

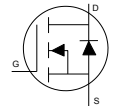
	Parameter	Max.	Units
V <sub>GS</sub>	Gate-to-Source Voltage	± 20	V
I <sub>D</sub> @ T <sub>A</sub> = 25°C	Continuous Drain Current, V <sub>GS</sub> @ 10V	11	A
I <sub>D</sub> @ T <sub>C(Bottom)</sub> = 25°C	Continuous Drain Current, V <sub>GS</sub> @ 10V	35	
I <sub>D</sub> @ T <sub>C(Bottom)</sub> = 100°C	Continuous Drain Current, V <sub>GS</sub> @ 10V	22	
I <sub>DM</sub>	Pulsed Drain Current ①	140	
P <sub>D</sub> @ T <sub>A</sub> = 25°C	Power Dissipation	3.6	W
P <sub>D</sub> @ T <sub>C(Bottom)</sub> = 25°C	Power Dissipation	39	
	Linear Derating Factor	0.03	W/°C
T <sub>J</sub>	Operating Junction and	-55 to + 150	°C
T <sub>STG</sub>	Storage Temperature Range		

Notes ① through ⑤ are on page 8

**Static @  $T_J = 25^\circ\text{C}$  (unless otherwise specified)**

	Parameter	Min.	Typ.	Max.	Units	Conditions
$BV_{DSS}$	Drain-to-Source Breakdown Voltage	100	—	—	V	$V_{GS} = 0V, I_D = 250\mu A$
$\Delta BV_{DSS}/\Delta T_J$	Breakdown Voltage Temp. Coefficient	—	78	—	mV/°C	Reference to $25^\circ\text{C}, I_D = 1mA$
$R_{DS(on)}$	Static Drain-to-Source On-Resistance	—	13.7	16.4	m $\Omega$	$V_{GS} = 10V, I_D = 21A$ ③
$V_{GS(th)}$	Gate Threshold Voltage	2.0	—	3.6	V	$V_{DS} = V_{GS}, I_D = 50\mu A$
$\Delta V_{GS(th)}$	Gate Threshold Voltage Coefficient	—	-5.2	—	mV/°C	
$I_{DSS}$	Drain-to-Source Leakage Current	—	—	1.0	$\mu A$	$V_{DS} = 80V, V_{GS} = 0V$
$I_{GSS}$	Gate-to-Source Forward Leakage	—	—	100	nA	$V_{GS} = 20V$
	Gate-to-Source Reverse Leakage	—	—	-100	nA	$V_{GS} = -20V$
$g_{fs}$	Forward Transconductance	45	—	—	S	$V_{DS} = 25V, I_D = 21A$
$Q_g$	Total Gate Charge	—	13	19	nC	$V_{DS} = 50V$ $V_{GS} = 10V$ $I_D = 21A$
$Q_{gs1}$	Pre-Vth Gate-to-Source Charge	—	1.8	—		
$Q_{gs2}$	Post-Vth Gate-to-Source Charge	—	0.9	—		
$Q_{gd}$	Gate-to-Drain Charge	—	4.3	—		
$Q_{godr}$	Gate Charge Overdrive	—	6.0	—		
$Q_{sw}$	Switch Charge ( $Q_{gs2} + Q_{gd}$ )	—	5.2	—		
$Q_{oss}$	Output Charge	—	40	—	nC	$V_{DS} = 50V, V_{GS} = 0V$
$R_G$	Gate Resistance	—	2.1	—	$\Omega$	
$t_{d(on)}$	Turn-On Delay Time	—	2.7	—	ns	$V_{DD} = 50V, V_{GS} = 10V$ $I_D = 21A$ $R_G = 1.0\Omega$
$t_r$	Rise Time	—	3.3	—		
$t_{d(off)}$	Turn-Off Delay Time	—	8.0	—		
$t_f$	Fall Time	—	2.5	—		
$C_{iss}$	Input Capacitance	—	733	—	pF	$V_{GS} = 0V$ $V_{DS} = 50V$ $f = 1.0MHz$
$C_{oss}$	Output Capacitance	—	374	—		
$C_{rss}$	Reverse Transfer Capacitance	—	11	—		

**Diode Characteristics**

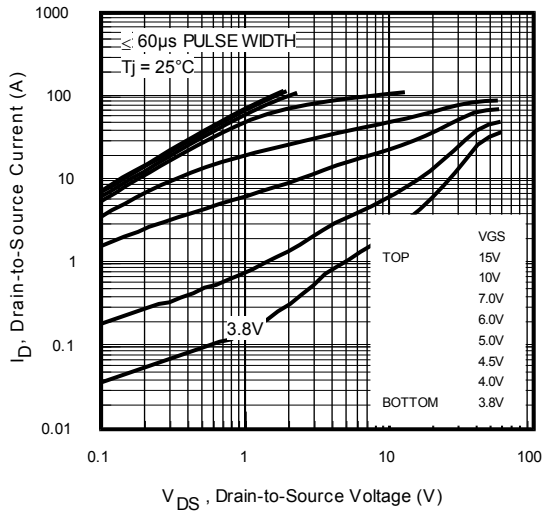
	Parameter	Min.	Typ.	Max.	Units	Conditions
$I_S$	Continuous Source Current (Body Diode)	—	—	35	A	MOSFET symbol showing the integral reverse p-n junction diode. 
$I_{SM}$	Pulsed Source Current (Body Diode) ①	—	—	140	A	
$V_{SD}$	Diode Forward Voltage	—	0.8	1.3	V	$T_J = 25^\circ\text{C}, I_S = 21A, V_{GS} = 0V$ ③
$t_{rr}$	Reverse Recovery Time	—	30	45	ns	$T_J = 25^\circ\text{C}, I_F = 21A, V_{DD} = 50V$
$Q_{rr}$	Reverse Recovery Charge	—	26	39	nC	$di/dt = 100A/\mu s$ ③

**Avalanche Characteristics**

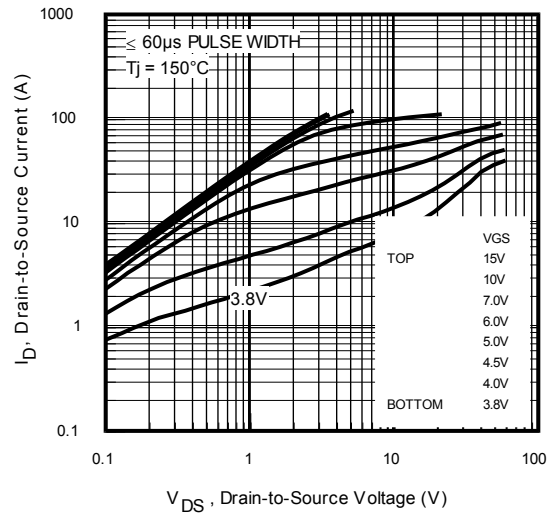
	Parameter	Typ.	Max.	Units
$E_{AS}$ (Thermally limited)	Single Pulse Avalanche Energy ②	—	220	mJ
$I_{AR}$	Avalanche Current ①	—	12	A

**Thermal Resistance**

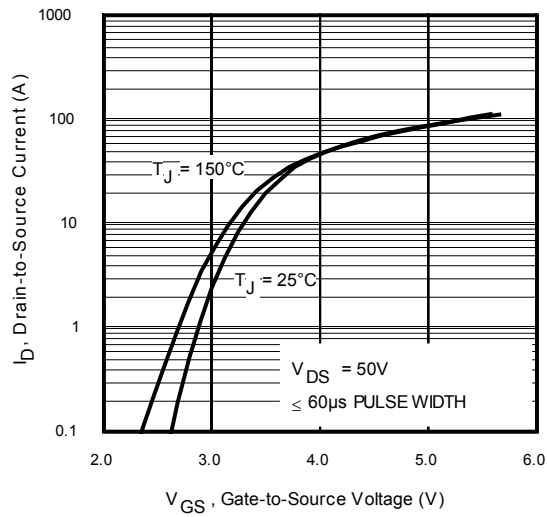
	Parameter	Typ.	Max.	Units
$R_{\theta JC}$ (Bottom)	Junction-to-Case ④	—	3.2	°C/W
$R_{\theta JC}$ (Top)	Junction-to-Case ④	—	22	
$R_{\theta JA}$	Junction-to-Ambient ⑤	—	35	
$R_{\theta JA} (<10s)$	Junction-to-Ambient ⑤	—	20	



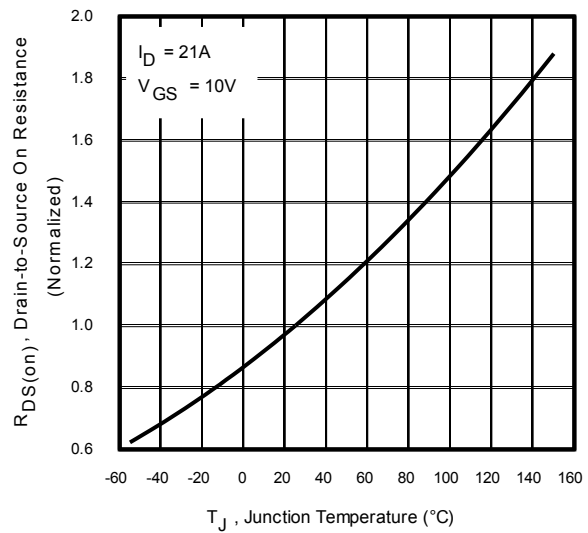
**Fig 1. Typical Output Characteristics**



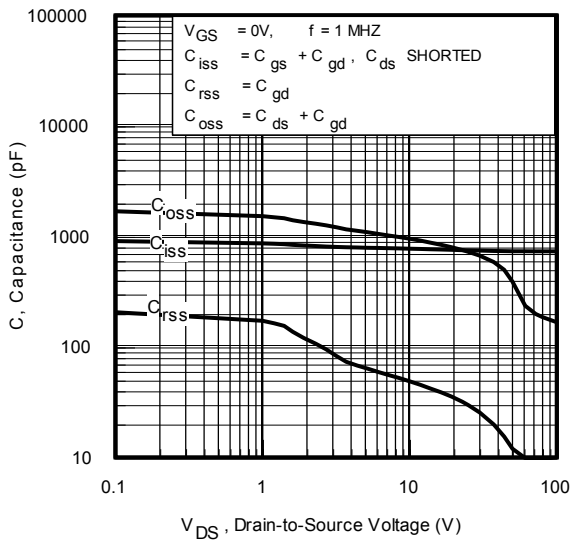
**Fig 2. Typical Output Characteristics**



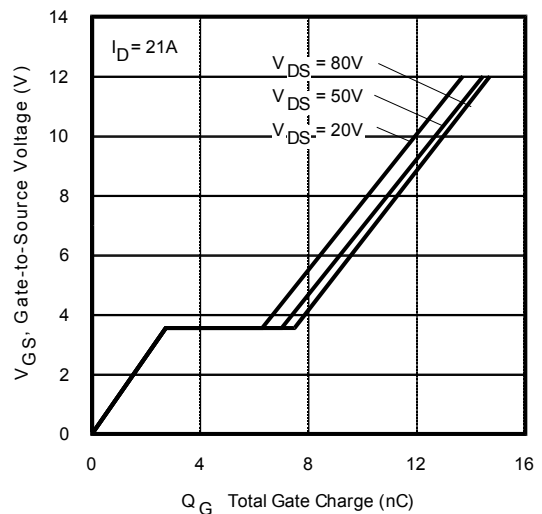
**Fig 3. Typical Transfer Characteristics**



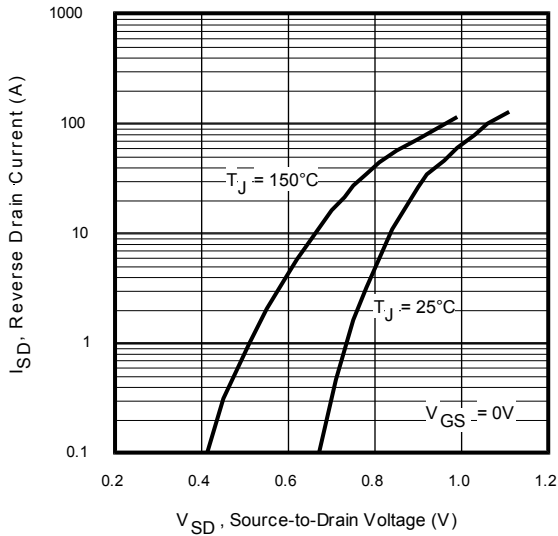
**Fig 4. Normalized On-Resistance vs. Temperature**



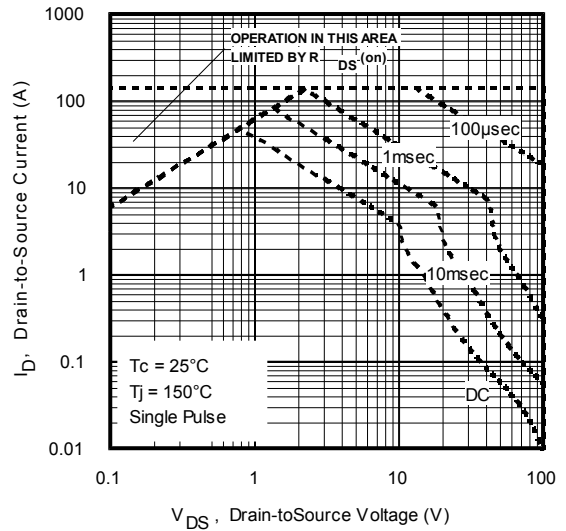
**Fig 5.**



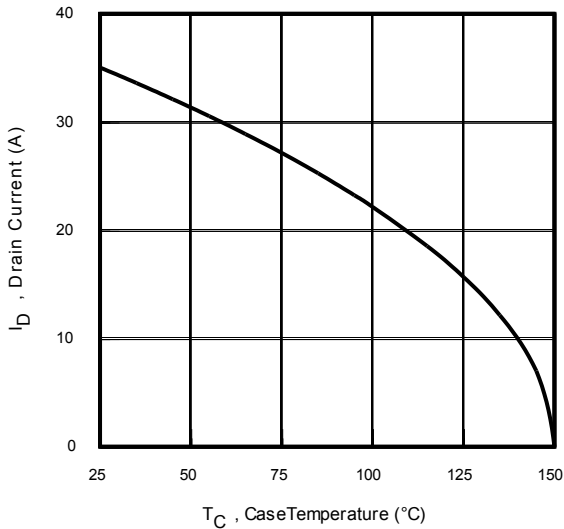
**Fig 6. Typical Gate Charge vs. Gate-to-Source Voltage**



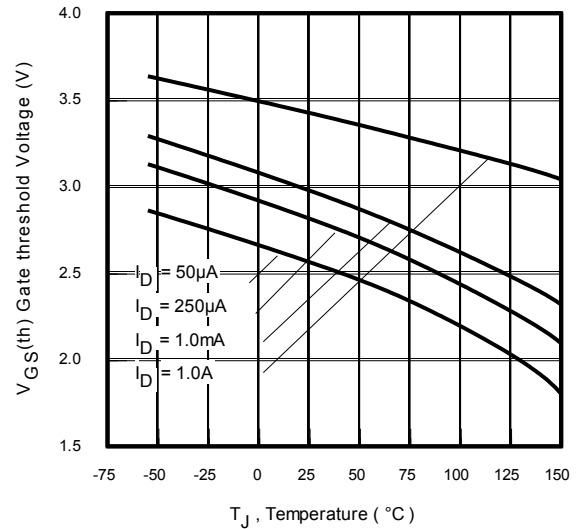
**Fig 7.** Typical Source-Drain Diode Forward Voltage



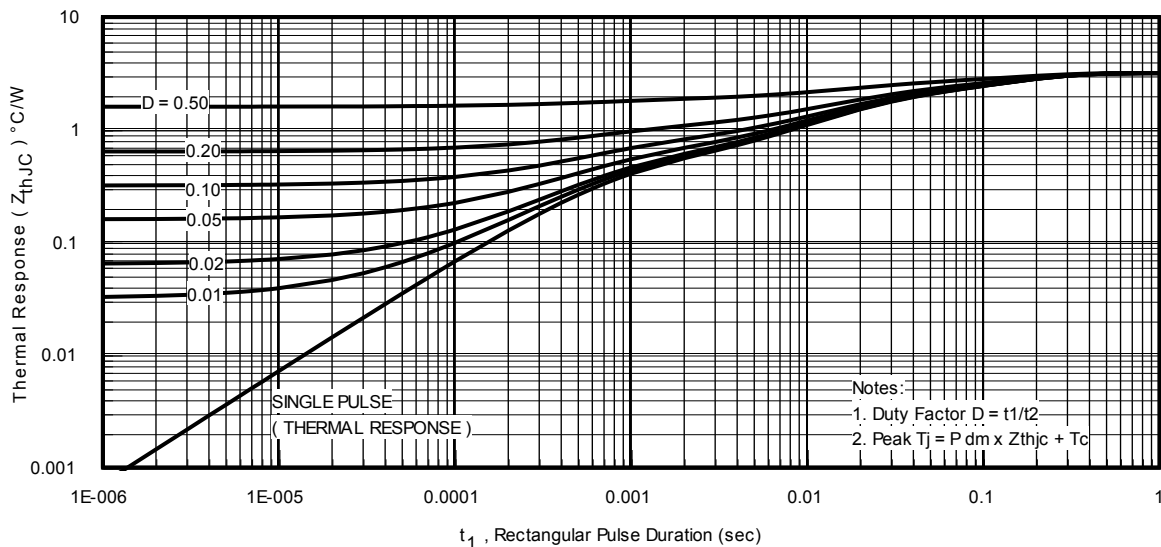
**Fig 8.** Maximum Safe Operating Area



**Fig 9.** Maximum Drain Current vs. Case Temperature



**Fig 10.** Threshold Voltage vs. Temperature



**Fig 11.** Maximum Effective Transient Thermal Impedance, Junction-to-Case

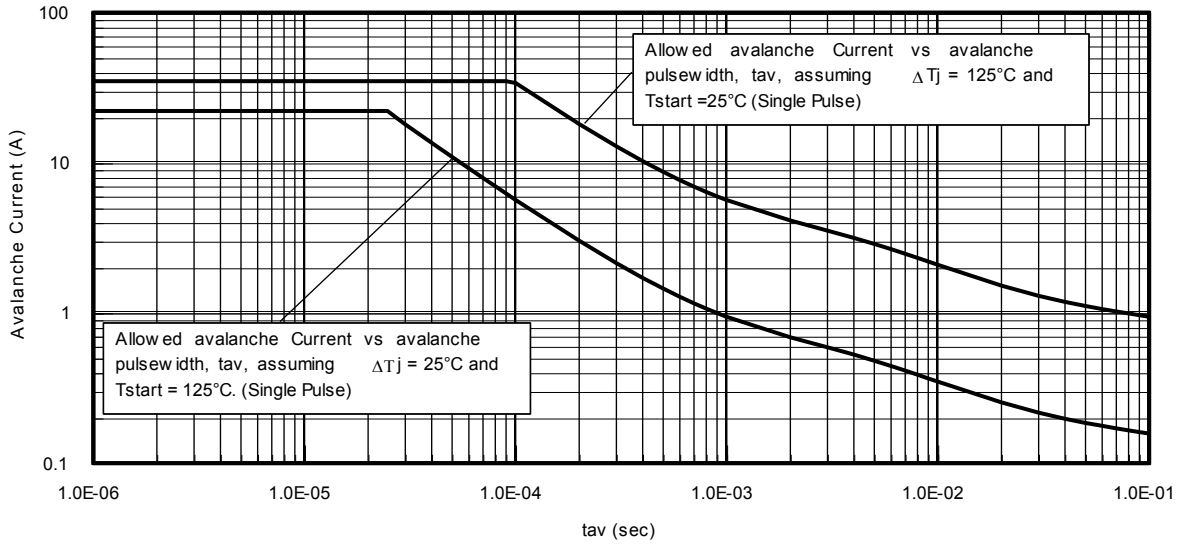


Fig 12. Typical Avalanche Current vs. Pulse Width

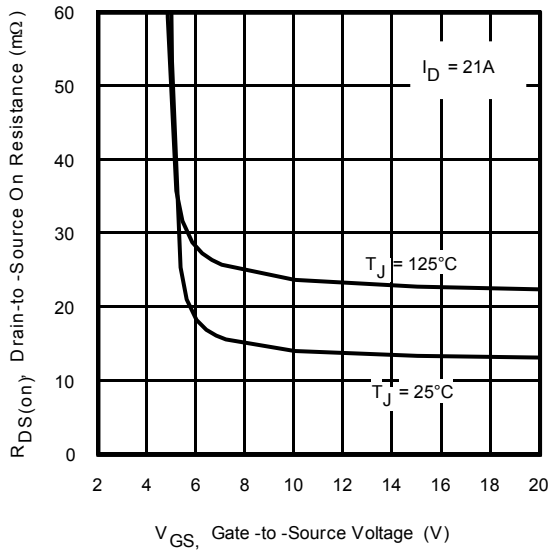


Fig 13. On-Resistance vs. Gate Voltage

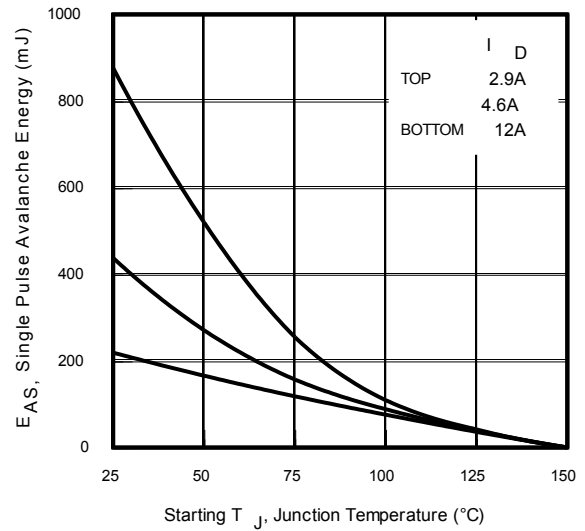
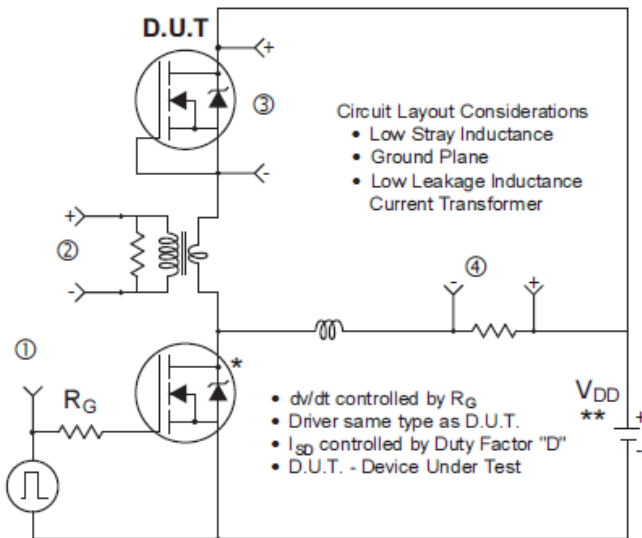
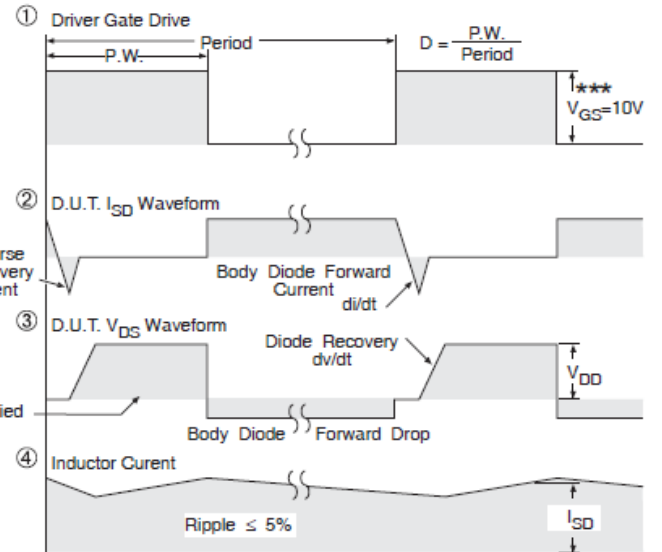


Fig 14. Maximum Avalanche Energy vs. Drain Current



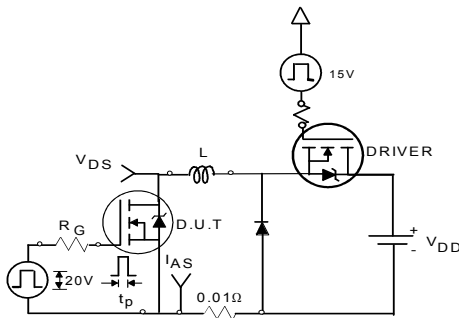
\* Use P-Channel Driver for P-Channel Measurements

\*\* Reverse Polarity for P-Channel

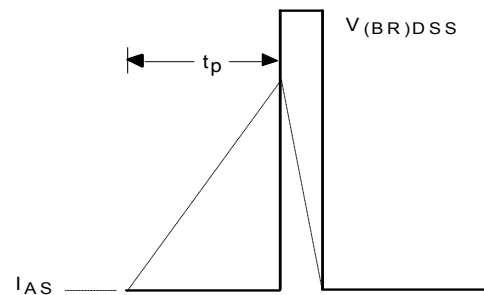


\*\*\*  $V_{GS} = 5V$  for Logic Level Devices

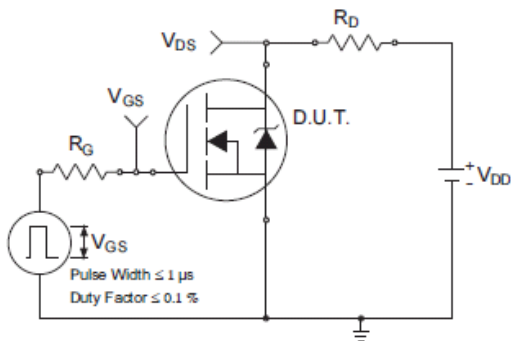
**Fig 15. Peak Diode Recovery  $dv/dt$  Test Circuit for N-Channel HEXFET® Power MOSFETs**



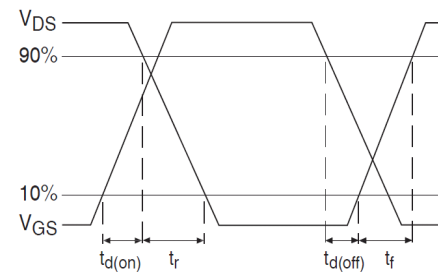
**Fig 16a. Unclamped Inductive Test Circuit**



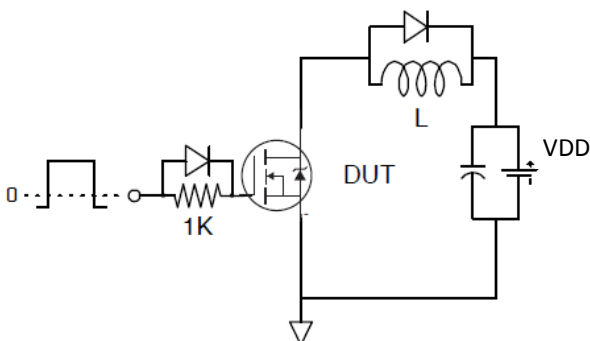
**Fig 16b. Unclamped Inductive Waveforms**



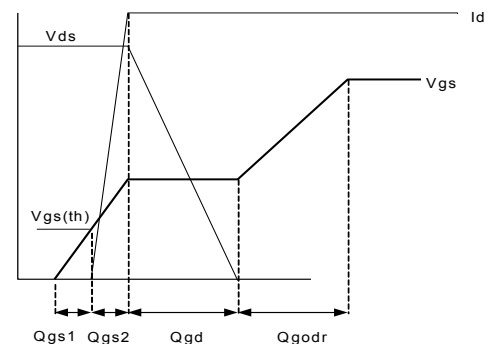
**Fig 17a. Switching Time Test Circuit**



**Fig 17b. Switching Time Waveforms**

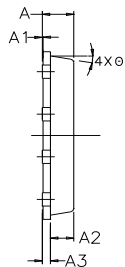


**Fig 18. Gate Charge Test Circuit**

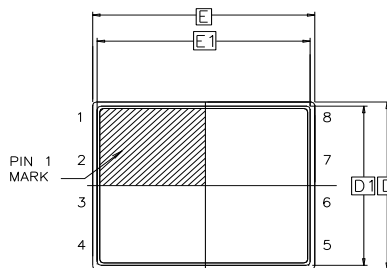


**Fig 19. Gate Charge Waveform**

**PQFN 5x6 Outline "B" Package Details**

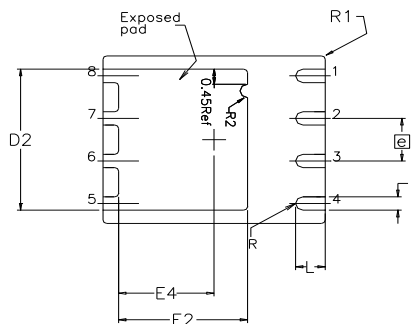


SIDE VIEW



TOP VIEW

SYMBOL	DIM	MIN	NOM	MAX
A		0.800	0.830	1.05
A1		0.000	0.020	0.050
A2		0.580	0.630	0.680
A3			0.254 REF	
Ø		0*	10*	12*
b		0.350	0.400	0.470
D		4.875	5.000	5.150
D1		4.675	4.750	5.000
D2		3.700	4.210	4.300
e			1.270 BSC	
E		5.850	6.000	6.150
E1		5.675	5.750	6.000
E2		3.380	3.480	3.760
E4		2.480	2.580	2.680
L		0.550	0.800	0.900
R			0.200 REF	
R1			0.100 REF	
R2		0.150	0.200	0.250

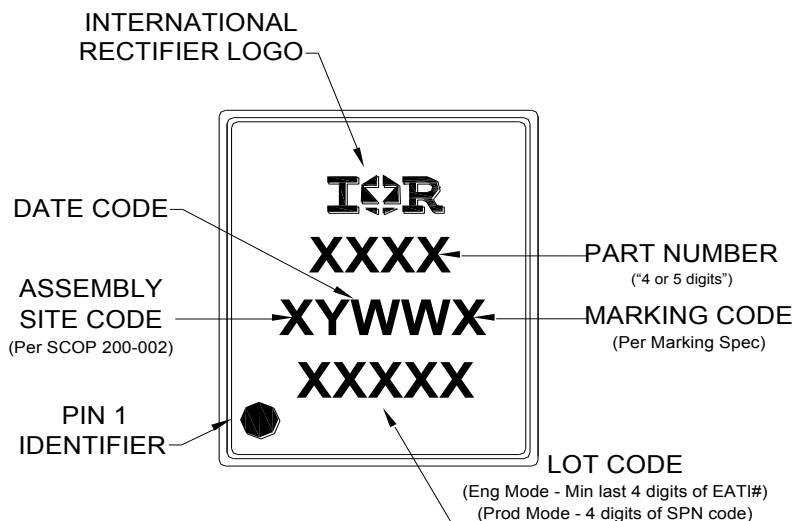


BOTTOM VIEW

For more information on board mounting, including footprint and stencil recommendation, please refer to application note AN-1136: <http://www.irf.com/technical-info/appnotes/an-1136.pdf>

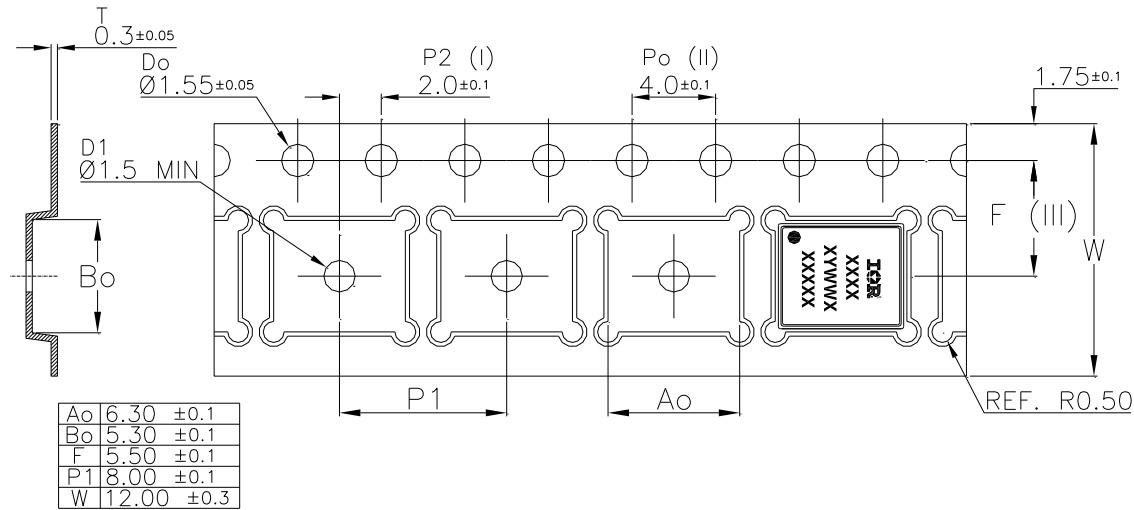
For more information on package inspection techniques, please refer to application note AN-1154: <http://www.irf.com/technical-info/appnotes/an-1154.pdf>

**PQFN 5x6 Outline "B" Part Marking**



Note: For the most current drawing please refer to IR website at <http://www.irf.com/package/>

**PQFN 5x6 Outline "B" Tape and Reel**



Note: For the most current drawing please refer to IR website at <http://www.irf.com/package/>

**Qualification Information<sup>†</sup>**

<b>Qualification Level</b>	Industrial (per JEDEC JESD47F <sup>††</sup> guidelines)	
<b>Moisture Sensitivity Level</b>	PQFN 5mm x 6mm	MSL1 (per JEDEC J-STD-020D <sup>††</sup> )
<b>RoHS Compliant</b>	Yes	

† Qualification standards can be found at International Rectifier's web site: <http://www.irf.com/product-info/reliability/>

†† Applicable version of JEDEC standard at the time of product release.

**Notes:**

- ① Repetitive rating; pulse width limited by max. junction temperature.
- ② Starting T<sub>J</sub> = 25°C, L = 3.0mH, R<sub>G</sub> = 50Ω, I<sub>AS</sub> = 12A.
- ③ Pulse width ≤ 400μs; duty cycle ≤ 2%.
- ④ R<sub>θ</sub> is measured at T<sub>J</sub> of approximately 90°C.
- ⑤ When mounted on 1 inch square PCB (FR-4). Please refer to AN-994 for more details:  
<http://www.irf.com/technical-info/appnotes/an-994.pdf>



# Mouser Electronics

Authorized Distributor

Click to View Pricing, Inventory, Delivery & Lifecycle Information:

[International Rectifier:](#)

[IRFH7194TRPBF](#)