

IRG4PH40KDPbF

INSULATED GATE BIPOLAR TRANSISTOR WITH
ULTRAFAST SOFT RECOVERY DIODE

Short Circuit Rated
UltraFast IGBT

Features

- High short circuit rating optimized for motor control, $t_{sc} = 10\mu s$, $V_{CC} = 720V$, $T_J = 125^\circ C$, $V_{GE} = 15V$
- Combines low conduction losses with high switching speed
- Tighter parameter distribution and higher efficiency than previous generations
- IGBT co-packaged with HEXFRED™ ultrafast, ultrasoft recovery antiparallel diodes
- Lead-Free

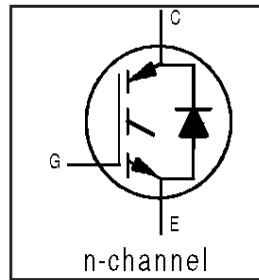

$V_{CES} = 1200V$
$V_{CE(on) typ.} = 2.74V$
@ $V_{GE} = 15V, I_C = 15A$

Benefits

- Latest generation 4 IGBT's offer highest power density motor controls possible
- HEXFRED™ diodes optimized for performance with IGBTs. Minimized recovery characteristics reduce noise, EMI and switching losses
- This part replaces the IRGPH40KD2 and IRGPH40MD2 products
- For hints see design tip 97003

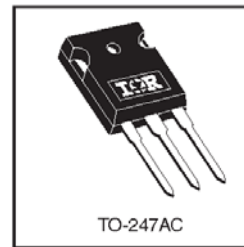

Absolute Maximum Ratings

	Parameter	Max.	Units
V_{CES}	Collector-to-Emitter Voltage	1200	V
$I_C @ T_C = 25^\circ C$	Continuous Collector Current	30	A
$I_C @ T_C = 100^\circ C$	Continuous Collector Current	15	
I_{CM}	Pulsed Collector Current ①	60	
I_{LM}	Clamped Inductive Load Current ②	60	
$I_F @ T_C = 100^\circ C$	Diode Continuous Forward Current	8.0	
I_{FM}	Diode Maximum Forward Current	130	
t_{sc}	Short Circuit Withstand Time	10	μs
V_{GE}	Gate-to-Emitter Voltage	± 20	V
$P_D @ T_C = 25^\circ C$	Maximum Power Dissipation	160	W
$P_D @ T_C = 100^\circ C$	Maximum Power Dissipation	65	
T_J	Operating Junction and Storage Temperature Range	-55 to +150	$^\circ C$
T_{STG}			
	Mounting Torque, 6-32 or M3 Screw.	10 lbf•in (1.1 N•m)	

Thermal Resistance

	Parameter	Min.	Typ.	Max.	Units
$R_{\theta JC}$	Junction-to-Case - IGBT	---	---	0.77	$^\circ C/W$
$R_{\theta JC}$	Junction-to-Case - Diode	---	---	1.7	
$R_{\theta CS}$	Case-to-Sink, flat, greased surface	---	0.24	---	
$R_{\theta JA}$	Junction-to-Ambient, typical socket mount	---	---	40	
Wt	Weight	---	6 (0.21)	---	g (oz)

Electrical Characteristics @ T_J = 25°C (unless otherwise specified)

	Parameter	Min.	Typ.	Max.	Units	Conditions
V _{(BR)CES}	Collector-to-Emitter Breakdown Voltage ^③	1200	—	—	V	V _{GE} = 0V, I _C = 250μA
ΔV _{(BR)CES} /ΔT _J	Temperature Coeff. of Breakdown Voltage	—	0.37	—	V/°C	V _{GE} = 0V, I _C = 1.0mA
V _{CE(on)}	Collector-to-Emitter Saturation Voltage	—	2.74	3.4	V	I _C = 15A I _C = 30A I _C = 15A, T _J = 150°C
		—	3.29	—		
		—	2.53	—		
V _{GE(th)}	Gate Threshold Voltage	3.0	—	6.0		V _{CE} = V _{GE} , I _C = 250μA
ΔV _{GE(th)} /ΔT _J	Temperature Coeff. of Threshold Voltage	—	-3.3	—	mV/°C	V _{CE} = V _{GE} , I _C = 250μA
g _{fe}	Forward Transconductance ^④	8.0	12	—	S	V _{CE} = 100V, I _C = 15A
I _{CES}	Zero Gate Voltage Collector Current	—	—	250	μA	V _{GE} = 0V, V _{CE} = 1200V V _{GE} = 0V, V _{CE} = 1200V, T _J = 150°C
		—	—	3000		
V _{FM}	Diode Forward Voltage Drop	—	2.6	3.3	V	I _C = 8.0A I _C = 8.0A, T _J = 125°C
		—	2.4	3.1		
I _{GES}	Gate-to-Emitter Leakage Current	—	—	±100	nA	V _{GE} = ±20V

Switching Characteristics @ T_J = 25°C (unless otherwise specified)

	Parameter	Min.	Typ.	Max.	Units	Conditions
Q _g	Total Gate Charge (tum-on)	—	94	140	nC	I _C = 15A V _{CC} = 400V V _{GE} = 15V
Q _{ge}	Gate - Emitter Charge (tum-on)	—	14	22		
Q _{gc}	Gate - Collector Charge (tum-on)	—	37	55		
t _{d(on)}	Turn-On Delay Time	—	50	—	ns	T _J = 25°C I _C = 15A, V _{CC} = 800V V _{GE} = 15V, R _G = 10Ω
t _r	Rise Time	—	31	—		
t _{d(off)}	Turn-Off Delay Time	—	96	140		
t _f	Fall Time	—	220	330		
E _{on}	Turn-On Switching Loss	—	1.31	—	mJ	Energy losses include "tail" and diode reverse recovery See Fig. 9,10,18
E _{off}	Turn-Off Switching Loss	—	1.12	—		
E _{ts}	Total Switching Loss	—	2.43	2.8		
t _{sc}	Short Circuit Withstand Time	10	—	—	μs	V _{CC} = 720V, T _J = 125°C V _{GE} = 15V, R _G = 10Ω, V _{OPK} < 500V
t _{d(on)}	Turn-On Delay Time	—	49	—	ns	T _J = 150°C, See Fig. 10,11,18 I _C = 15A, V _{CC} = 800V V _{GE} = 15V, R _G = 10Ω, Energy losses include "tail" and diode reverse recovery
t _r	Rise Time	—	33	—		
t _{d(off)}	Turn-Off Delay Time	—	290	—		
t _f	Fall Time	—	440	—		
E _{ts}	Total Switching Loss	—	5.1	—	mJ	
L _E	Internal Emitter Inductance	—	13	—	nH	Measured 5mm from package
C _{ies}	Input Capacitance	—	1600	—	pF	V _{GE} = 0V V _{CC} = 30V f = 1.0MHz
C _{oes}	Output Capacitance	—	77	—		
C _{res}	Reverse Transfer Capacitance	—	26	—		
t _{rr}	Diode Reverse Recovery Time	—	63	95	ns	T _J = 25°C T _J = 125°C
		—	106	160		
I _{rr}	Diode Peak Reverse Recovery Current	—	4.5	8.0	A	T _J = 25°C T _J = 125°C
		—	6.2	11		
Q _{rr}	Diode Reverse Recovery Charge	—	140	380	nC	T _J = 25°C T _J = 125°C
		—	335	880		
di _{(rec)M} /dt	Diode Peak Rate of Fall of Recovery During t _b	—	133	—	A/μs	T _J = 25°C T _J = 125°C
		—	85	—		

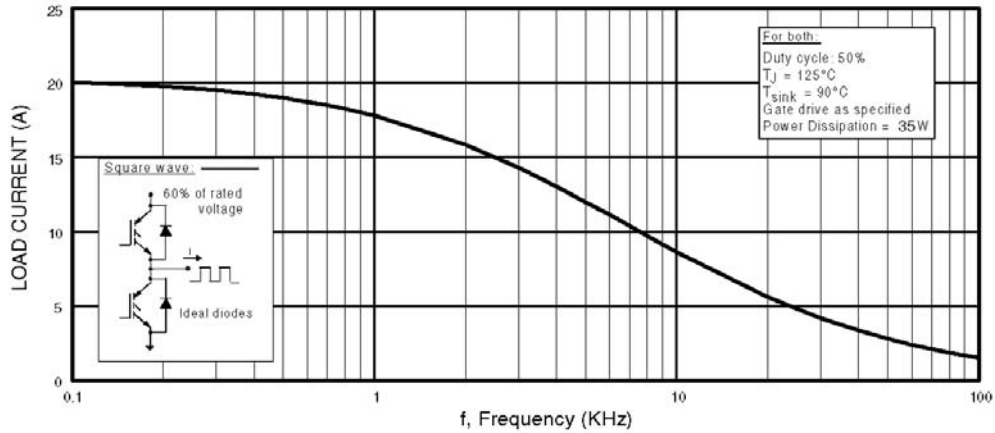

Fig. 1 - Typical Load Current vs. Frequency
 (Load Current = I_{RMS} of fundamental)

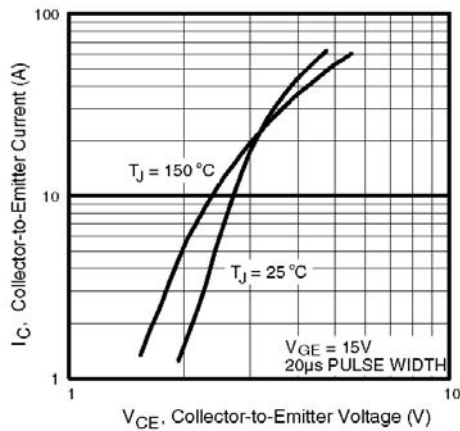

Fig. 2 - Typical Output Characteristics

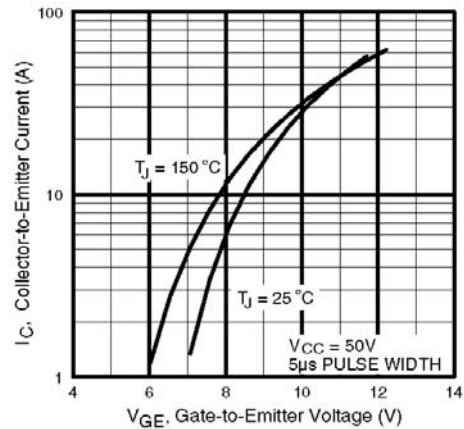

Fig. 3 - Typical Transfer Characteristics

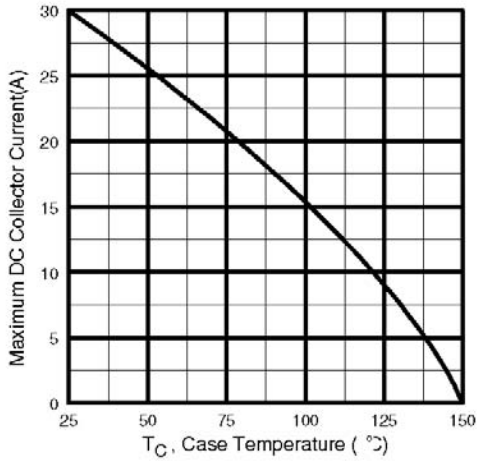

Fig. 4 - Maximum Collector Current vs. Case Temperature

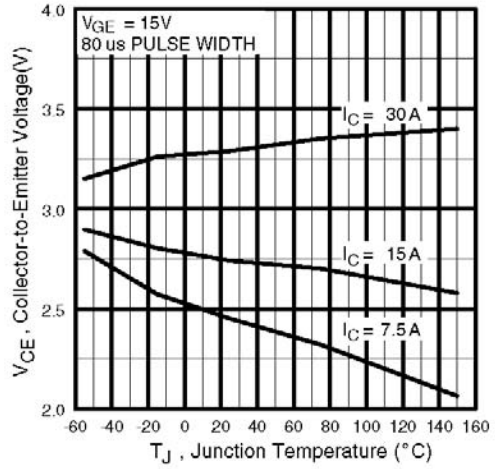

Fig. 5 - Typical Collector-to-Emitter Voltage vs. Junction Temperature

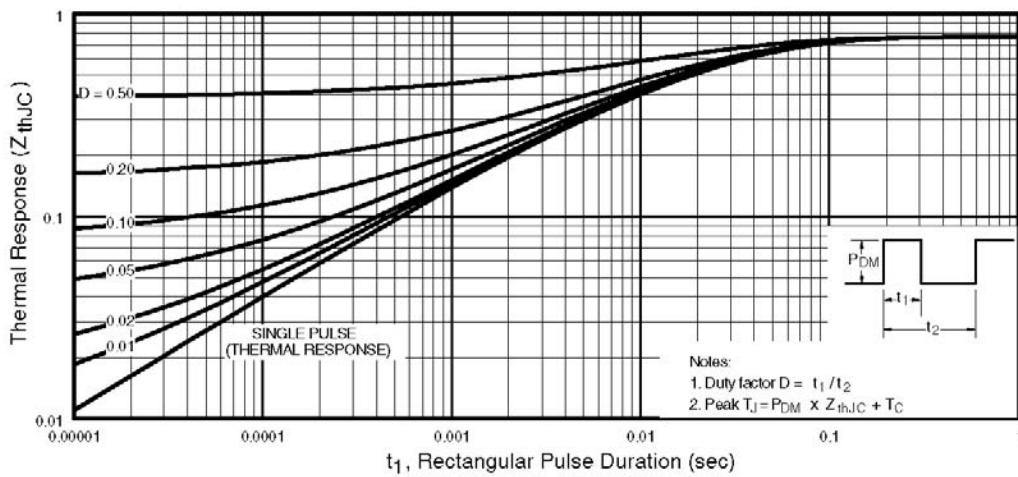

Fig. 6 - Maximum Effective Transient Thermal Impedance, Junction-to-Case

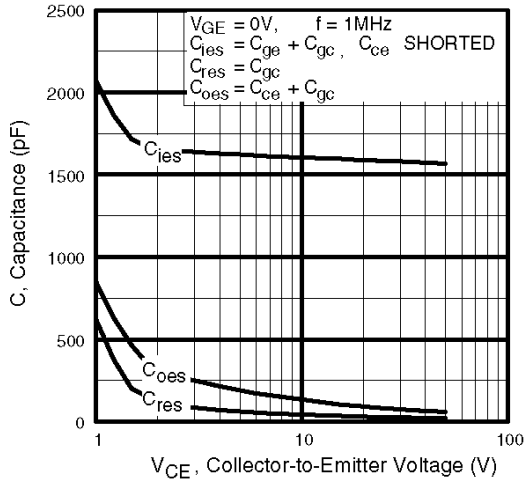

Fig. 7 - Typical Capacitance vs. Collector-to-Emitter Voltage

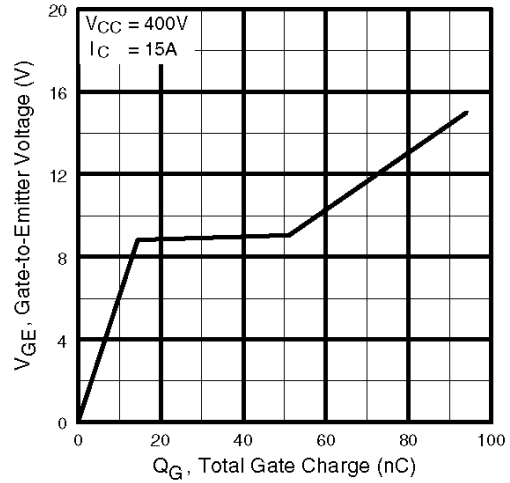

Fig. 8 - Typical Gate Charge vs. Gate-to-Emitter Voltage

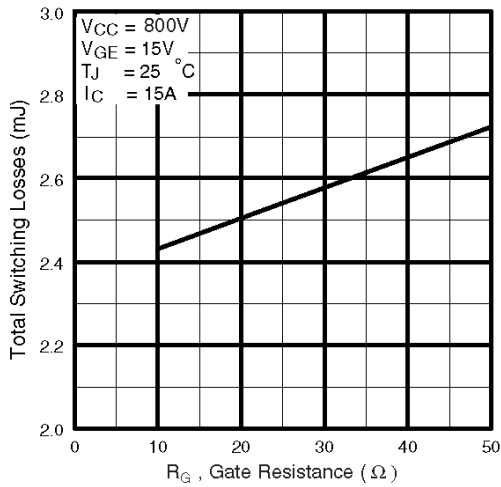

Fig. 9 - Typical Switching Losses vs. Gate Resistance

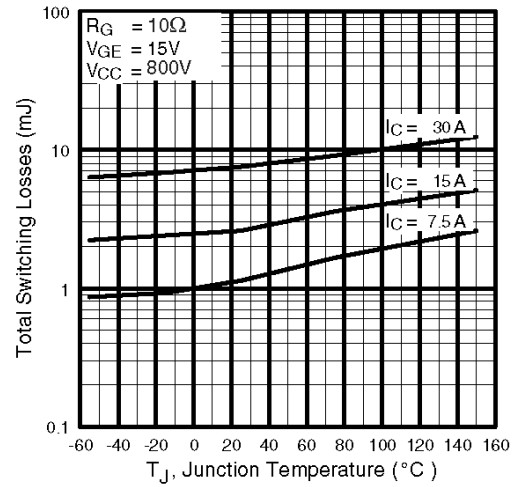

Fig. 10 - Typical Switching Losses vs. Junction Temperature

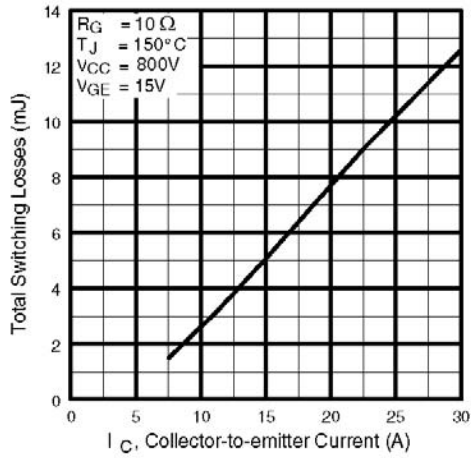

Fig. 11 - Typical Switching Losses vs. Collector-to-Emitter Current

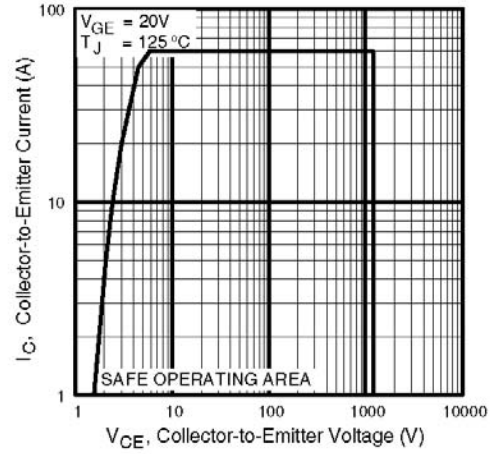

Fig. 12 - Turn-Off SOA

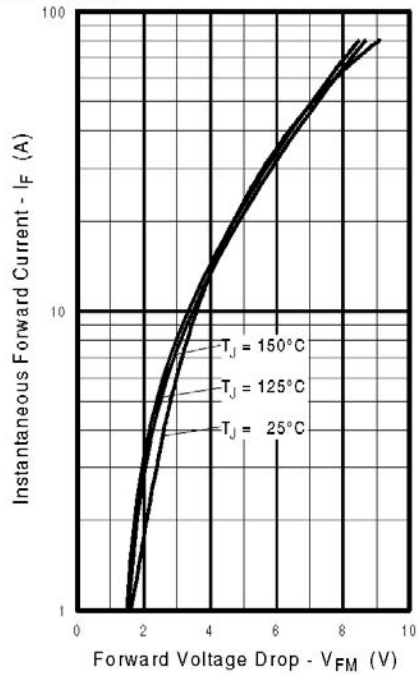

Fig. 13 - Maximum Forward Voltage Drop vs. Instantaneous Forward Current

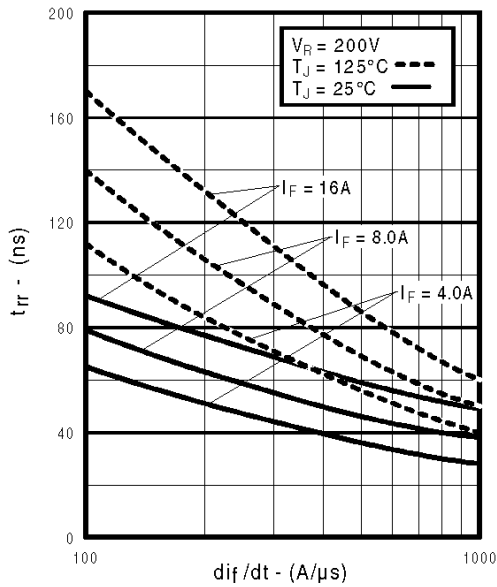

Fig. 14 - Typical Reverse Recovery vs. di_f/dt

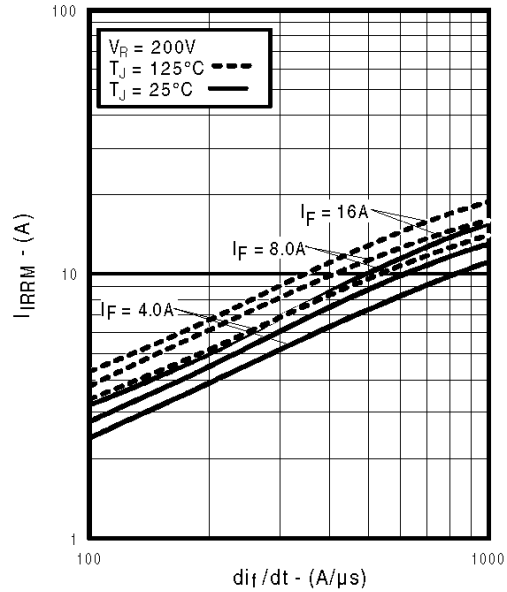

Fig. 15 - Typical Recovery Current vs. di_f/dt

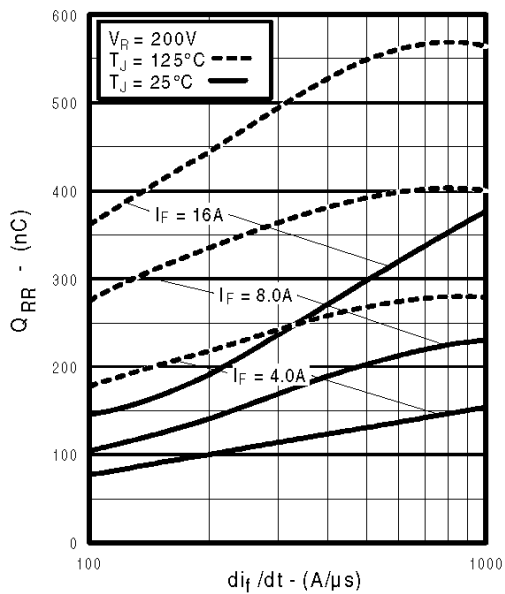

Fig. 16 - Typical Stored Charge vs. di_f/dt

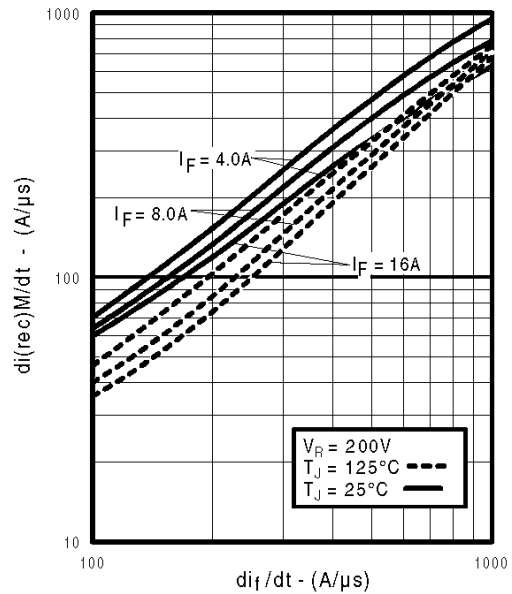

Fig. 17 - Typical $di_{(rec)M}/dt$ vs. di_f/dt

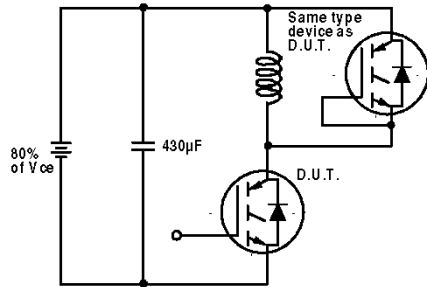

Fig. 18a - Test Circuit for Measurement of I_{LM} , E_{on} , $E_{off}(\text{diode})$, t_{rr} , Q_{rr} , I_{rr} , $t_{d(on)}$, t_r , $t_{d(off)}$, t_f

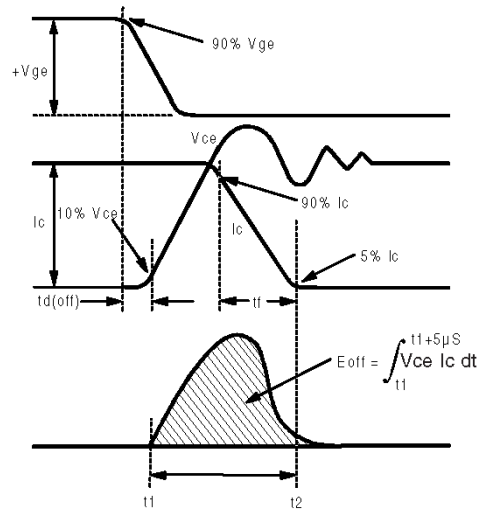

Fig. 18b - Test Waveforms for Circuit of Fig. 18a, Defining E_{off} , $t_{d(off)}$, t_f

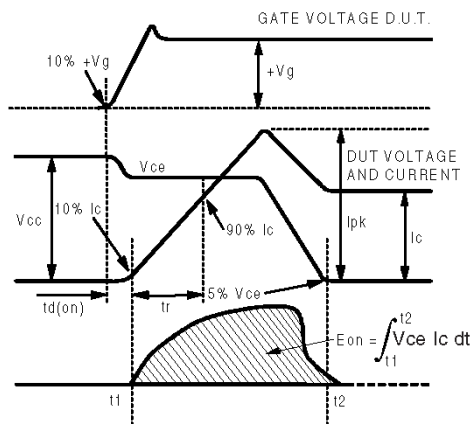

Fig. 18c - Test Waveforms for Circuit of Fig. 18a, Defining E_{on} , $t_{d(on)}$, t_r

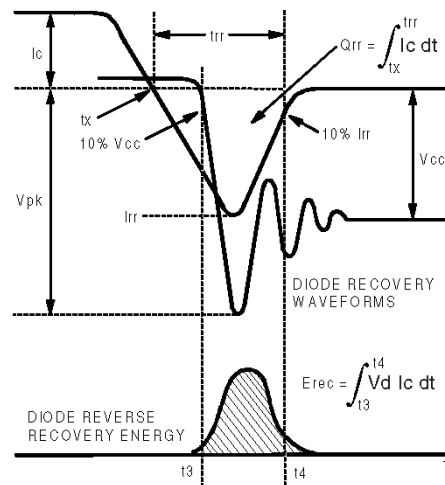

Fig. 18d - Test Waveforms for Circuit of Fig. 18a, Defining E_{rec} , t_{rr} , Q_{rr} , I_{rr}

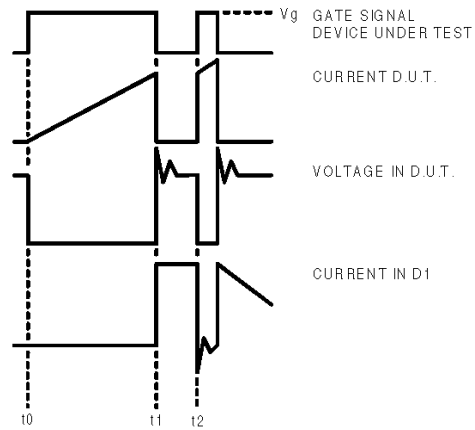

Figure 18e. Macro Waveforms for Figure 18a's Test Circuit

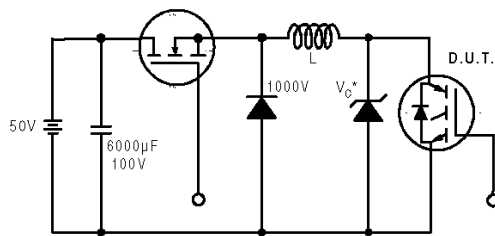

Figure 19. Clamped Inductive Load Test Circuit

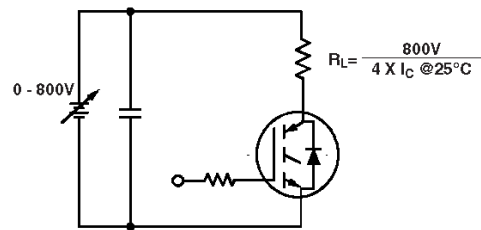

Figure 20. Pulsed Collector Current Test Circuit

IRG4PH40KDPbF

International
IR Rectifier

Notes:

- ① Repetitive rating: $V_{GE}=20V$; pulse width limited by maximum junction temperature (figure 20)
- ② $V_{CC}=80\%(V_{CES})$, $V_{GE}=20V$, $L=10\mu H$, $R_G=10\Omega$ (figure 19)
- ③ Pulse width $\leq 80\mu s$; duty factor $\leq 0.1\%$.
- ④ Pulse width $5.0\mu s$, single shot.

TO-247AC Package Outline

Dimensions are shown in millimeters (inches)

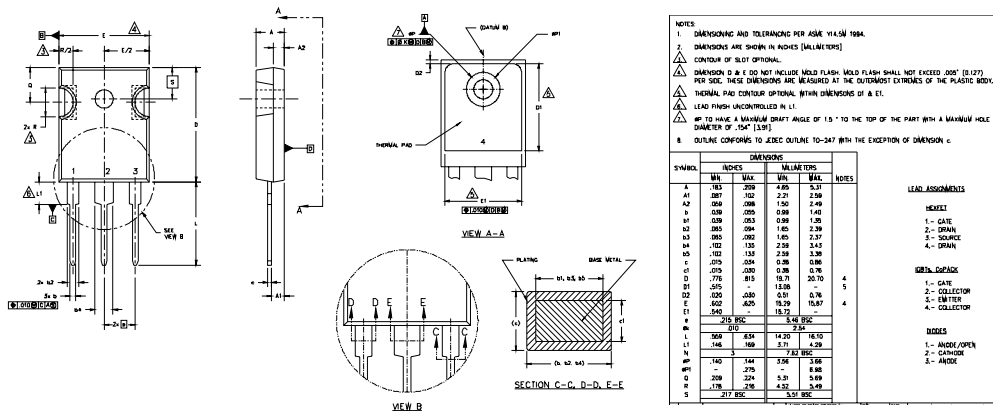

TO-247AC Part Marking Information

EXAMPLE: THIS IS AN IRFP30
 WITH ASSEMBLY
 LOT CODE 5667
 ASSEMBLED ON WW 35, 2000
 IN THE ASSEMBLY LINE "H"
 Note: "P" in assembly line
 position indicates "Lead-Free"

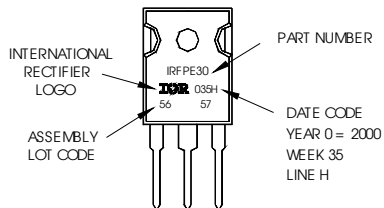

Data and specifications subject to change without notice.

International
IR Rectifier

IR WORLD HEADQUARTERS: 233 Kansas St., El Segundo, California 90245, USA Tel: (310) 252-7105
 TAC Fax: (310) 252-7903

Visit us at www.irf.com for sales contact information.06/04
www.irf.com

Note: For the most current drawings please refer to the IR website at:
<http://www.irf.com/package/>

Mouser Electronics

Authorized Distributor

Click to View Pricing, Inventory, Delivery & Lifecycle Information:

[International Rectifier:](#)

[IRG4PH40KDPBF](#)