

# PolarHV™ HiPerFET IXFR 80N50P

## Power MOSFET

### ISOPLUS247™

(Electrically Isolated Back Surface)

N-Channel Enhancement Mode  
Avalanche Rated  
Fast Intrinsic Diode

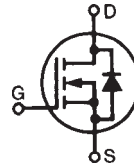

$$\begin{aligned} V_{DSS} &= 500 \text{ V} \\ I_{D25} &= 45 \text{ A} \\ R_{DS(on)} &\leq 72 \text{ m}\Omega \\ t_{rr} &\leq 200 \text{ ns} \end{aligned}$$

Symbol	Test Conditions	Maximum Ratings	
$V_{DSS}$	$T_J = 25^\circ\text{C}$ to $150^\circ\text{C}$	500	V
$V_{DGR}$	$T_J = 25^\circ\text{C}$ to $150^\circ\text{C}$ ; $R_{GS} = 1 \text{ M}\Omega$	500	V
$V_{GSM}$	Transient	$\pm 40$	V
$V_{GSM}$	Continuous	$\pm 30$	V
$I_{D25}$	$T_C = 25^\circ\text{C}$	45	A
$I_{DM}$	$T_C = 25^\circ\text{C}$ , pulse width limited by $T_{JM}$	200	A
$I_{AR}$	$T_C = 25^\circ\text{C}$	80	A
$E_{AR}$	$T_C = 25^\circ\text{C}$	80	mJ
$E_{AS}$	$T_C = 25^\circ\text{C}$	3.5	J
$dv/dt$	$I_S \leq I_{DM}$ , $di/dt \leq 100 \text{ A}/\mu\text{s}$ , $V_{DD} \leq V_{DSS}$ , $T_J \leq 150^\circ\text{C}$ , $R_G = 2 \Omega$	20	V/ns
$P_D$	$T_C = 25^\circ\text{C}$	360	W
$T_J$		-55 ... +150	$^\circ\text{C}$
$T_{JM}$		150	$^\circ\text{C}$
$T_{stg}$		-55 ... +150	$^\circ\text{C}$
$T_L$	Maximum lead temperature for soldering	300	$^\circ\text{C}$
$F_C$	Mounting force	20..120/4.5..25	N/lb
$V_{ISOL}$	50/60 Hz, RMS, 1 minute	2500	V~
<b>Weight</b>		5	g

ISOPLUS247 (IXFR)  
E153432

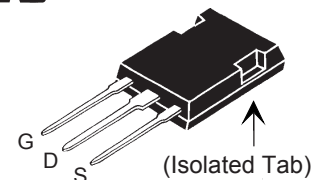

G = Gate      D = Drain  
S = Source

#### Features

- † Silicon chip on Direct-Copper-Bond substrate
- High power dissipation
- Isolated mounting surface
- 2500V electrical isolation
- † Low drain to tab capacitance (<30pF)
- † Low  $R_{DS(on)}$  HDMOS™ process
- † Rugged polysilicon gate cell structure
- † Rated for Unclamped Inductive Load Switching (UIS)
- † Fast intrinsic Rectifier

#### Applications

- † DC-DC converters
- † Battery chargers
- † Switched-mode and resonant-mode power supplies
- † DC choppers
- † AC motor control

#### Advantages

- † Easy assembly
- † Space savings
- † High power density

Symbol	Test Conditions ( $T_J = 25^\circ\text{C}$ unless otherwise specified)	Characteristic Values		
		Min.	Typ.	Max.
$BV_{DSS}$	$V_{GS} = 0 \text{ V}$ , $I_D = 500 \mu\text{A}$	500		V
$V_{GS(th)}$	$V_{DS} = V_{GS}$ , $I_D = 8 \text{ mA}$	3.0		5.0 V
$I_{GSS}$	$V_{GS} = \pm 30 \text{ V}_{DC}$ , $V_{DS} = 0$			$\pm 200 \text{ nA}$
$I_{DSS}$	$V_{DS} = V_{DSS}$ , $V_{GS} = 0 \text{ V}$ , $T_J = 125^\circ\text{C}$			25 $\mu\text{A}$ 2 mA
$R_{DS(on)}$	$V_{GS} = 10 \text{ V}$ , $I_D = 40 \text{ A}$			72 m $\Omega$

Symbol	Test Conditions	Characteristic Values		
		(T <sub>J</sub> = 25° C unless otherwise specified)		
		Min.	Typ.	Max.
<b>g<sub>fs</sub></b>	V <sub>DS</sub> = 20 V; I <sub>D</sub> = 40 A, I <sub>D25</sub> , Note 1	45	70	S
<b>C<sub>iss</sub></b>			12.7	nF
<b>C<sub>oss</sub></b>	V <sub>GS</sub> = 0 V, V <sub>DS</sub> = 25 V, f = 1 MHz		1280	pF
<b>C<sub>rss</sub></b>			120	pF
<b>t<sub>d(on)</sub></b>			25	ns
<b>t<sub>r</sub></b>	V <sub>GS</sub> = 10 V, V <sub>DS</sub> = 0.5 V <sub>DSS</sub> , I <sub>D</sub> = 40 A		27	ns
<b>t<sub>d(off)</sub></b>	R <sub>G</sub> = 1 Ω (External)		70	ns
<b>t<sub>f</sub></b>			16	ns
<b>Q<sub>g(on)</sub></b>			197	nC
<b>Q<sub>gs</sub></b>	V <sub>GS</sub> = 10 V, V <sub>DS</sub> = 0.5 V <sub>DSS</sub> , I <sub>D</sub> = 40 A		70	nC
<b>Q<sub>gd</sub></b>			64	nC
<b>R<sub>thJC</sub></b>				0.35° C/W
<b>R<sub>thCS</sub></b>		0.15		° C/W

Symbol	Test Conditions	Characteristic Values		
		(T <sub>J</sub> = 25° C unless otherwise specified)		
		Min.	Typ.	Max.
<b>I<sub>S</sub></b>	V <sub>GS</sub> = 0 V			80 A
<b>I<sub>SM</sub></b>	Repetitive			200 A
<b>V<sub>SD</sub></b>	I <sub>F</sub> = I <sub>S</sub> , V <sub>GS</sub> = 0 V,			1.5 V
<b>t<sub>rr</sub></b>	I <sub>F</sub> = 25 A, -di/dt = 100 A/μs			200 ns
<b>Q<sub>RM</sub></b>	V <sub>R</sub> = 100 V, V <sub>GS</sub> = 0 V		0.6	μC
<b>I<sub>RM</sub></b>			6	A

Notes:

1. Pulse test, t ≤ 300 μs, duty cycle d ≤ 2 %

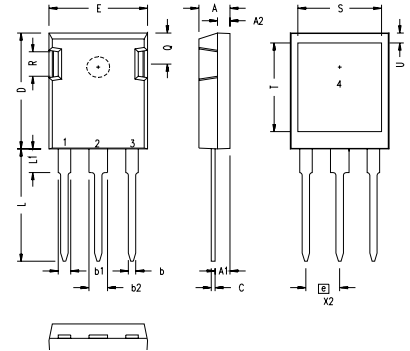
**ISOPLUS247™ Outline**

SYM	INCHES		MILLIMETERS	
	MIN	MAX	MIN	MAX
A	.190	.205	4.83	5.21
A1	.090	.100	2.29	2.54
A2	.075	.085	1.91	2.16
b	.045	.055	1.14	1.40
b1	.075	.084	1.91	2.13
b2	.115	.123	2.92	3.12
C	.024	.031	0.61	0.80
D	.819	.840	20.80	21.34
E	.620	.635	15.75	16.13
e	.215 BSC		5.45 BSC	
L	.780	.800	19.81	20.32
L1	.150	.170	3.81	4.32
Q	.220	.244	5.59	6.20
R	.170	.190	4.32	4.83
S	.520	.540	13.21	13.72
T	.620	.640	15.75	16.26
U	.065	.080	1.65	2.03

- 1 - GATE
- 2 - DRAIN (COLLECTOR)
- 3 - SOURCE (EMITTER)
- 4 - NO CONNECTION

NOTE: This drawing will meet all dimensions requirement of JEDEC outline TO-247AD except screw hole.

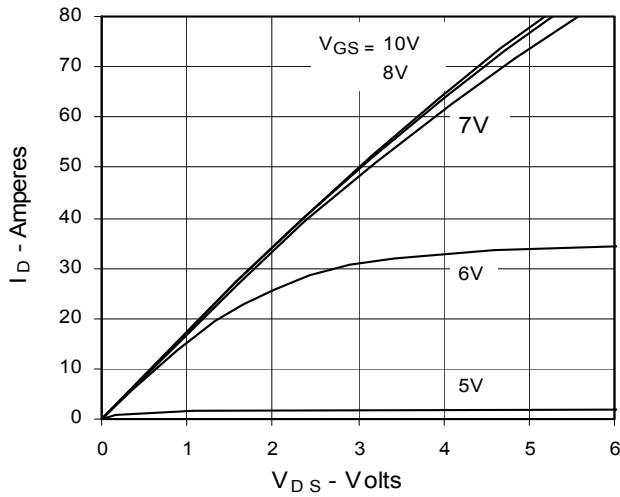
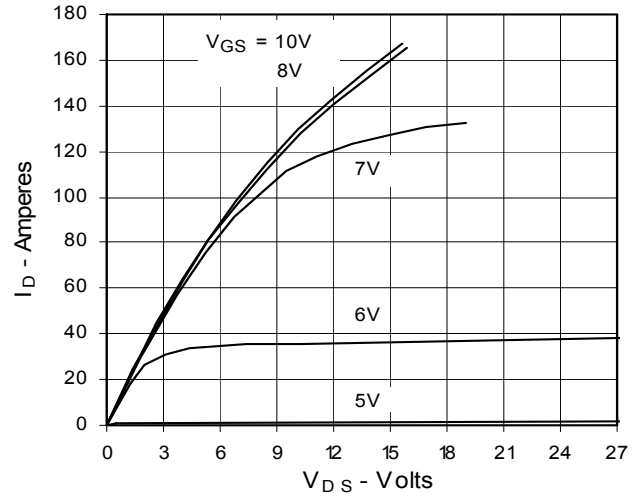
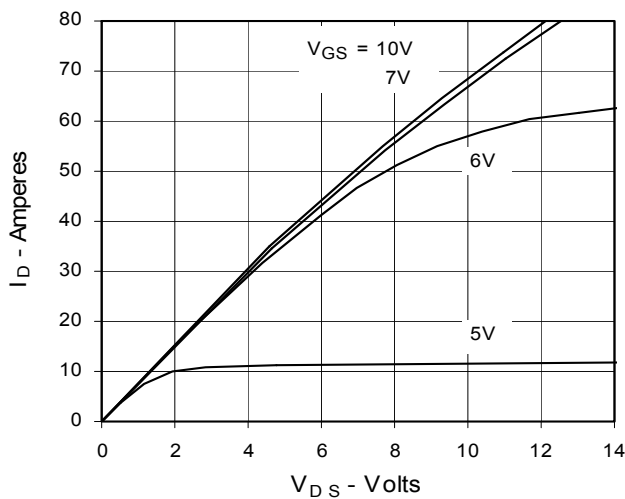
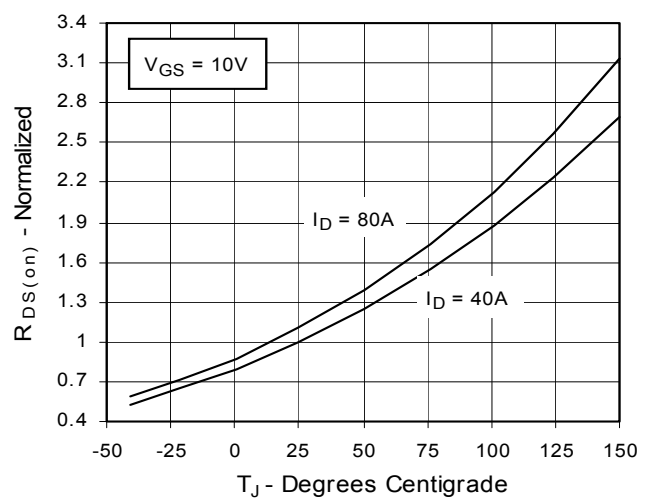
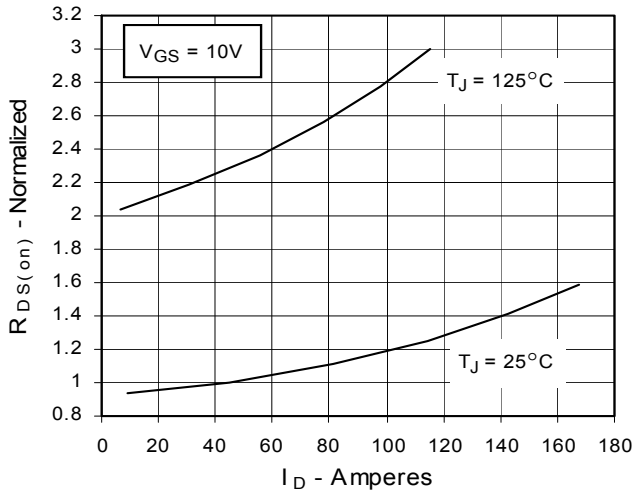
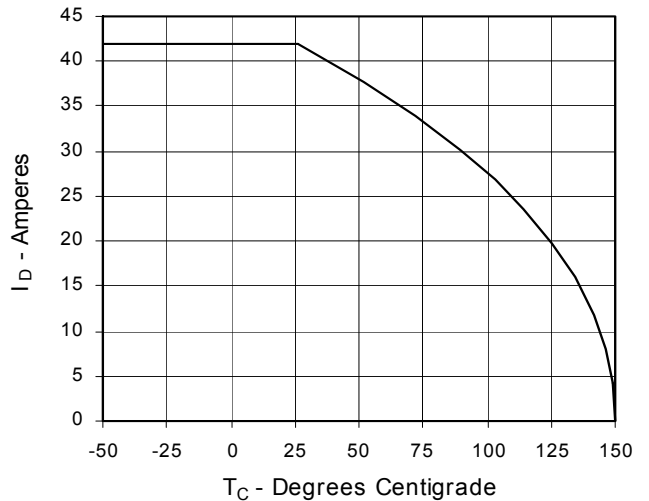
**Fig. 1. Output Characteristics  
@ 25°C**

**Fig. 2. Extended Output Characteristics  
@ 25°C**

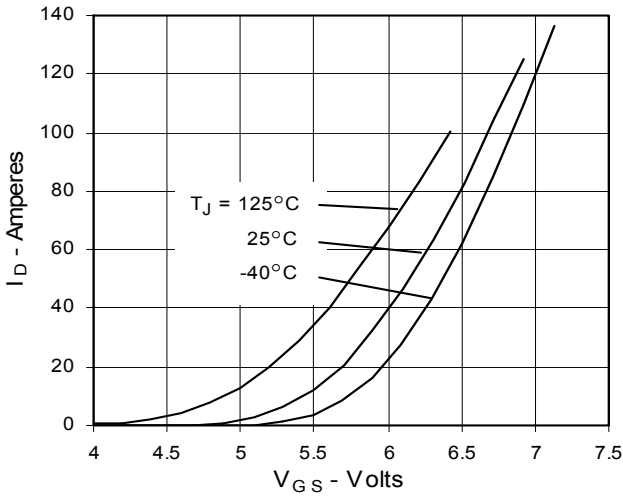
**Fig. 3. Output Characteristics  
@ 125°C**

**Fig. 4.  $R_{DS(on)}$  Normalized to  $I_D = 40$  A  
Value vs. Junction Temperature**

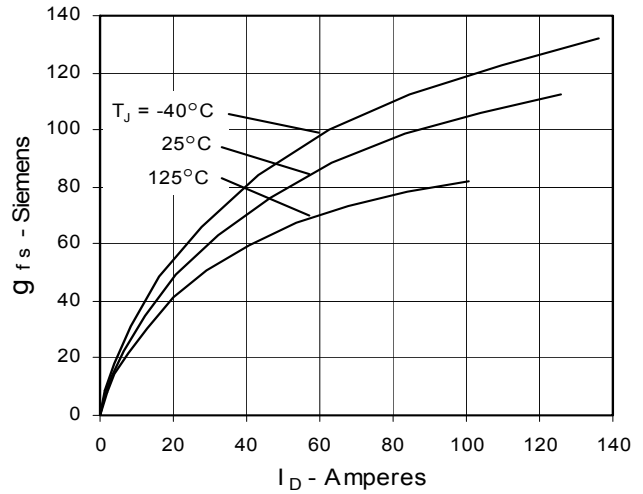
**Fig. 5.  $R_{DS(on)}$  Normalized to  
 $I_D = 40$  A Value vs.  $I_D$** 

**Fig. 6. Drain Current vs. Case  
Temperature**

**Fig. 7. Input Admittance**



**Fig. 8. Transconductance**



**Fig. 9. Source Current vs. Source-To-Drain Voltage**

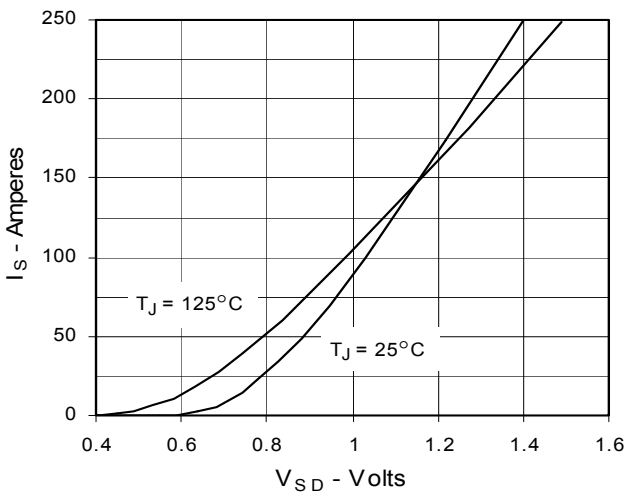

**Fig. 10. Gate Charge**

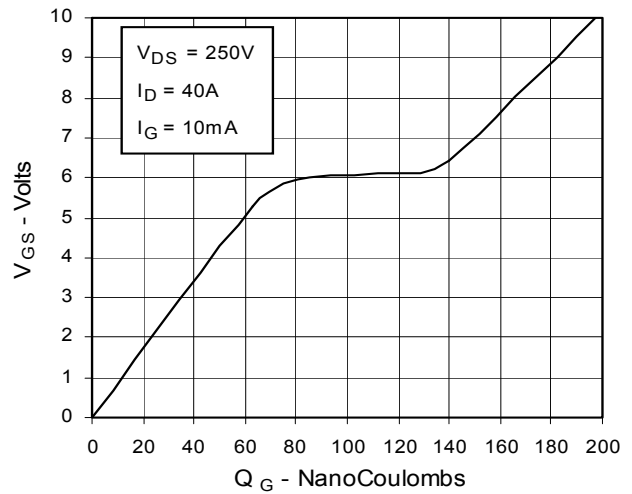

**Fig. 11. Capacitance**

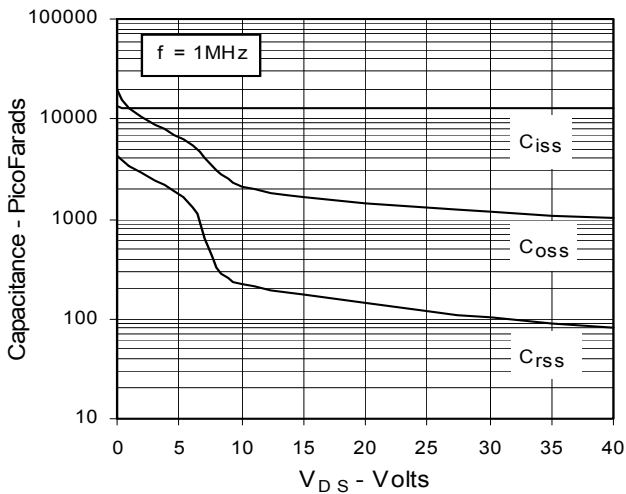

**Fig. 12. Forward-Bias Safe Operating Area**

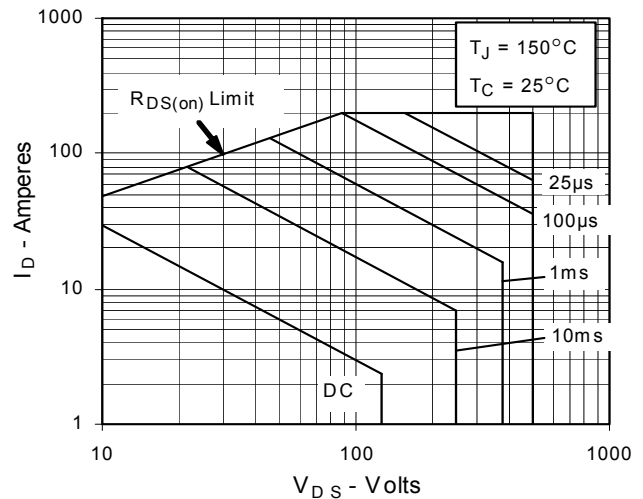
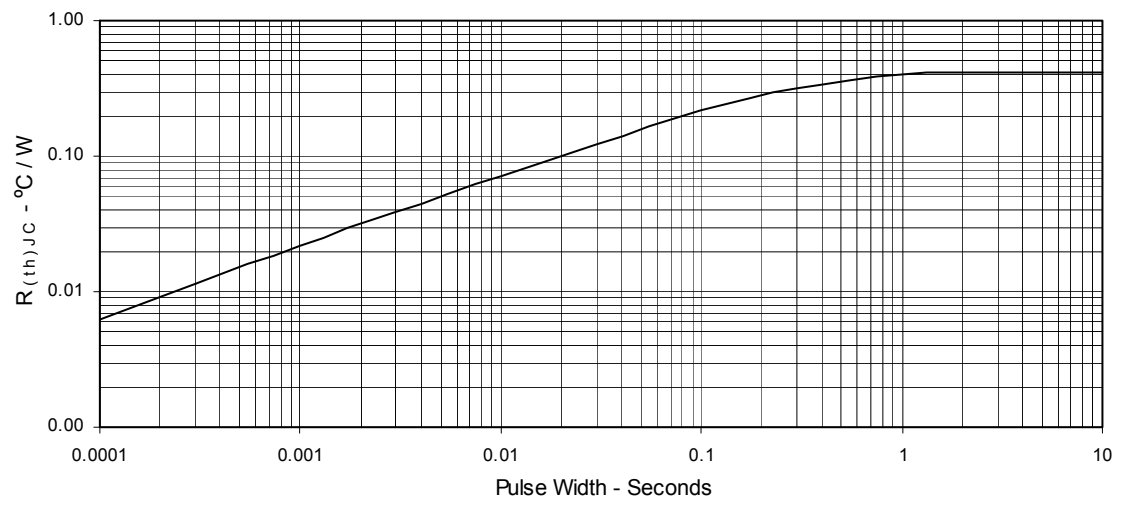

Fig. 13. Maximum Transient Thermal Resistance



# Mouser Electronics

Authorized Distributor

Click to View Pricing, Inventory, Delivery & Lifecycle Information:

[IXYS:](#)

[IXFR80N50P](#)