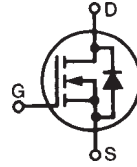

**GigaMOS™**  
**Power MOSFET**
**IXFK140N25T**  
**IXFX140N25T**

 N-Channel Enhancement Mode  
 Avalanche Rated  
 Fast Intrinsic Diode

$$V_{DSS} = 250V$$

$$I_{D25} = 140A$$

$$R_{DS(on)} \leq 17m\Omega$$

$$t_{rr} \leq 200ns$$

TO-264 (IXFK)

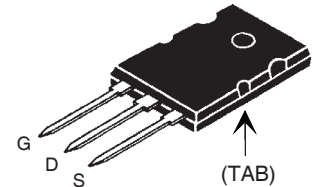

PLUS247 (IXFX)

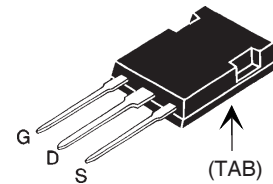
 G = Gate      D = Drain  
 S = Source    TAB = Drain

Symbol	Test Conditions	Maximum Ratings	
$V_{DSS}$	$T_J = 25^\circ C$ to $150^\circ C$	250	V
$V_{DGR}$	$T_J = 25^\circ C$ to $150^\circ C$ , $R_{GS} = 1M\Omega$	250	V
$V_{GSS}$	Continuous	$\pm 20$	V
$V_{GSM}$	Transient	$\pm 30$	V
$I_{D25}$	$T_C = 25^\circ C$	140	A
$I_{DM}$	$T_C = 25^\circ C$ , Pulse Width Limited by $T_{JM}$	380	A
$I_A$	$T_C = 25^\circ C$	40	A
$E_{AS}$	$T_C = 25^\circ C$	3	J
$P_D$	$T_C = 25^\circ C$	960	W
$dV/dt$	$I_S \leq I_{DM}$ , $V_{DD} \leq V_{DSS}$ , $T_J \leq 150^\circ C$	20	V/ns
$T_J$		-55 ... +150	$^\circ C$
$T_{JM}$		150	$^\circ C$
$T_{stg}$		-55 ... +150	$^\circ C$
$T_L$	1.6mm (0.062 in.) from Case for 10s	300	$^\circ C$
$T_{SOLD}$	Plastic Body for 10s	260	$^\circ C$
$M_d$	Mounting Torque (TO-264)	1.13/10	Nm/lb.in.
$F_c$	Mounting Force (PLUS247)	20..120 / 4.5..27	N/lb.
<b>Weight</b>	TO-264	10	g
	PLUS247	6	g

**Features**

- International Standard Packages
- High Current Handling Capability
- Fast Intrinsic Diode
- Avalanche Rated
- Low  $R_{DS(on)}$

**Advantages**

- Easy to Mount
- Space Savings
- High Power Density

**Applications**

- DC-DC Converters
- Battery Chargers
- Switched-Mode and Resonant-Mode Power Supplies
- DC Choppers
- AC Motor Drives
- Uninterruptible Power Supplies
- High Speed Power Switching Applications

Symbol	Test Conditions ( $T_J = 25^\circ C$ Unless Otherwise Specified)	Characteristic Values		
		Min.	Typ.	Max.
$BV_{DSS}$	$V_{GS} = 0V$ , $I_D = 3mA$	250		V
$V_{GS(th)}$	$V_{DS} = V_{GS}$ , $I_D = 4mA$	2.5		5.0 V
$I_{GSS}$	$V_{GS} = \pm 20V$ , $V_{DS} = 0V$			$\pm 200$ nA
$I_{DSS}$	$V_{DS} = V_{DSS}$ , $V_{GS} = 0V$ $T_J = 125^\circ C$			50 $\mu A$ 3 mA
$R_{DS(on)}$	$V_{GS} = 10V$ , $I_D = 60A$ , Note 1			17 m $\Omega$

Symbol	Test Conditions	Characteristic Values		
		Min.	Typ.	Max.
$g_{fs}$	$V_{DS} = 10V, I_D = 60A$ , Note 1	80	135	S
$C_{iss}$	$V_{GS} = 0V, V_{DS} = 25V, f = 1MHz$		19	nF
$C_{oss}$			1500	pF
$C_{rss}$			185	pF
$t_{d(on)}$	<b>Resistive Switching Times</b> $V_{GS} = 15V, V_{DS} = 0.5 \cdot V_{DSS}, I_D = 0.5 \cdot I_{D25}$ $R_G = 1\Omega$ (External)		33	ns
$t_r$			29	ns
$t_{d(off)}$			92	ns
$t_f$			22	ns
$Q_{g(on)}$	$V_{GS} = 10V, V_{DS} = 0.5 \cdot V_{DSS}, I_D = 0.5 \cdot I_{D25}$		255	nC
$Q_{gs}$			90	nC
$Q_{gd}$			62	nC
$R_{thJC}$			0.13	$^{\circ}C/W$
$R_{thCS}$		0.15		$^{\circ}C/W$

### Source-Drain Diode

Symbol	Test Conditions	Characteristic Values		
		Min.	Typ.	Max.
$I_S$	$V_{GS} = 0V$			140 A
$I_{SM}$	Repetitive, Pulse Width Limited by $T_{JM}$			560 A
$V_{SD}$	$I_F = 60A, V_{GS} = 0V$ , Note 1			1.3 V
$t_{rr}$	$I_F = 70A, -di/dt = 100A/\mu s$ $V_R = 75V, V_{GS} = 0V$			200 ns
$Q_{RM}$			0.60	$\mu C$
$I_{RM}$			9.30	A

Note 1: Pulse Test,  $t \leq 300\mu s$ ; Duty Cycle,  $d \leq 2\%$ .

### ADVANCE TECHNICAL INFORMATION

The product presented herein is under development. The Technical Specifications offered are derived from a subjective evaluation of the design, based upon prior knowledge and experience, and constitute a "considered reflection" of the anticipated result. IXYS reserves the right to change limits, test conditions, and dimensions without notice.

IXYS Reserves the Right to Change Limits, Test Conditions, and Dimensions.

IXYS MOSFETs and IGBTs are covered by one or more of the following U.S. patents:

4,835,592	4,931,844	5,049,961	5,237,481	6,162,665	6,404,065 B1	6,683,344	6,727,585	7,005,734 B2	7,157,338B2
4,850,072	5,017,508	5,063,307	5,381,025	6,259,123 B1	6,534,343	6,710,405 B2	6,759,692	7,063,975 B2	
4,881,106	5,034,796	5,187,117	5,486,715	6,306,728 B1	6,583,505	6,710,463	6,771,478 B2	7,071,537	

### TO-264 (IXFK) Outline

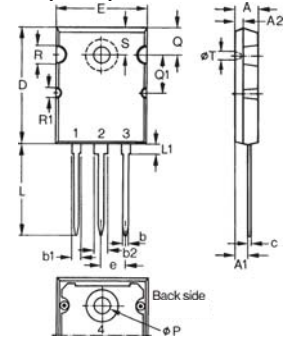

Dim.	Millimeter		Inches	
	Min.	Max.	Min.	Max.
A	4.82	5.13	.190	.202
A1	2.54	2.89	.100	.114
A2	2.00	2.10	.079	.083
b	1.12	1.42	.044	.056
b1	2.39	2.69	.094	.106
b2	2.90	3.09	.114	.122
c	0.53	0.83	.021	.033
D	25.91	26.16	1.020	1.030
E	19.81	19.96	.780	.786
e	5.46 BSC		.215 BSC	
J	0.00	0.25	.000	.010
K	0.00	0.25	.000	.010
L	20.32	20.83	.800	.820
L1	2.29	2.59	.090	.102
P	3.17	3.66	.125	.144
Q	6.07	6.27	.239	.247
Q1	8.38	8.69	.330	.342
R	3.81	4.32	.150	.170
R1	1.78	2.29	.070	.090
S	6.04	6.30	.238	.248
T	1.57	1.83	.062	.072

### PLUS 247™ (IXFX) Outline

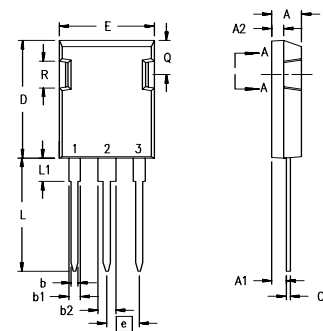

Terminals: 1 - Gate  
2 - Drain (Collector)  
3 - Source (Emitter)  
4 - Drain (Collector)

Dim.	Millimeter		Inches	
	Min.	Max.	Min.	Max.
A	4.83	5.21	.190	.205
A <sub>1</sub>	2.29	2.54	.090	.100
A <sub>2</sub>	1.91	2.16	.075	.085
b	1.14	1.40	.045	.055
b <sub>1</sub>	1.91	2.13	.075	.084
b <sub>2</sub>	2.92	3.12	.115	.123
C	0.61	0.80	.024	.031
D	20.80	21.34	.819	.840
E	15.75	16.13	.620	.635
e	5.45 BSC		.215 BSC	
L	19.81	20.32	.780	.800
L1	3.81	4.32	.150	.170
Q	5.59	6.20	.220	0.244
R	4.32	4.83	.170	.190

**Fig. 1. Output Characteristics @ 25°C**

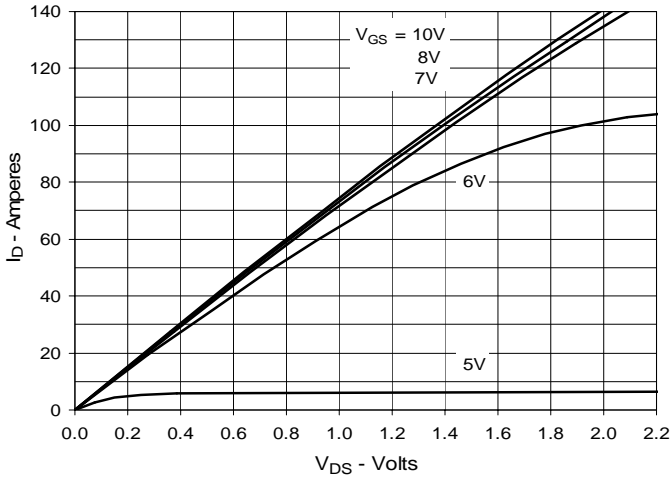

**Fig. 2. Extended Output Characteristics @ 25°C**

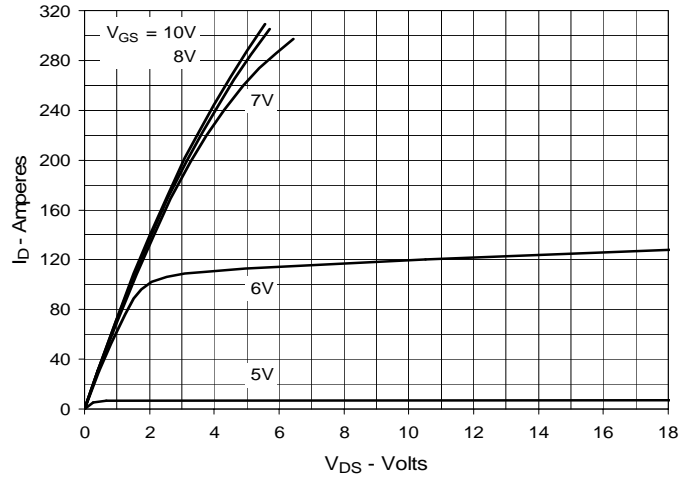

**Fig. 3. Output Characteristics @ 125°C**

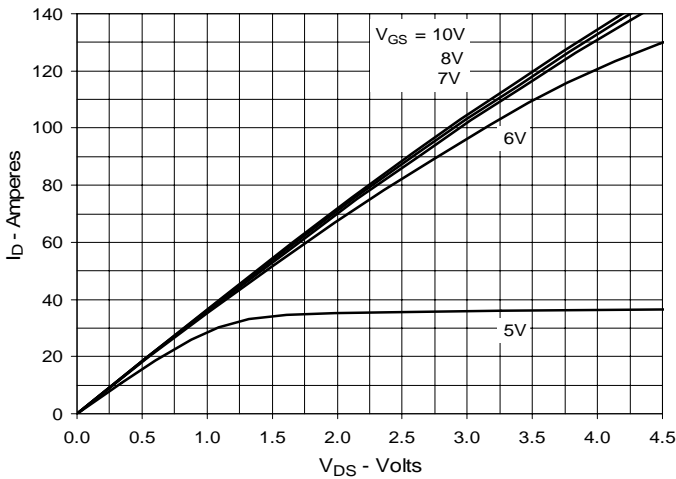

**Fig. 4.  $R_{DS(on)}$  Normalized to  $I_D = 70A$  Value vs. Junction Temperature**

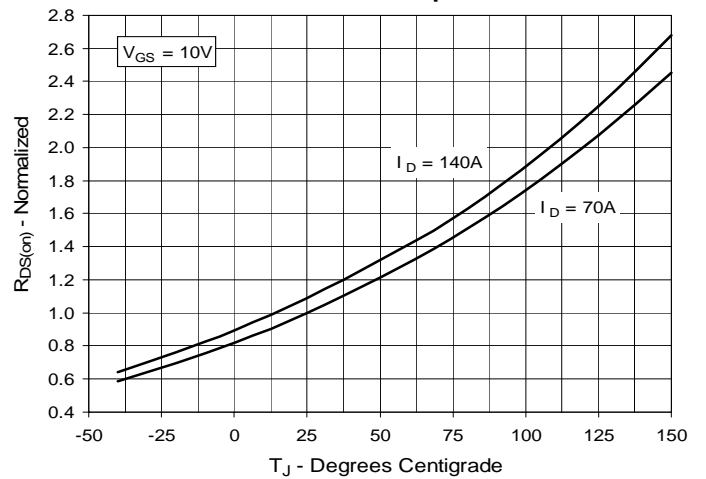

**Fig. 5.  $R_{DS(on)}$  Normalized to  $I_D = 70A$  Value vs. Drain Current**

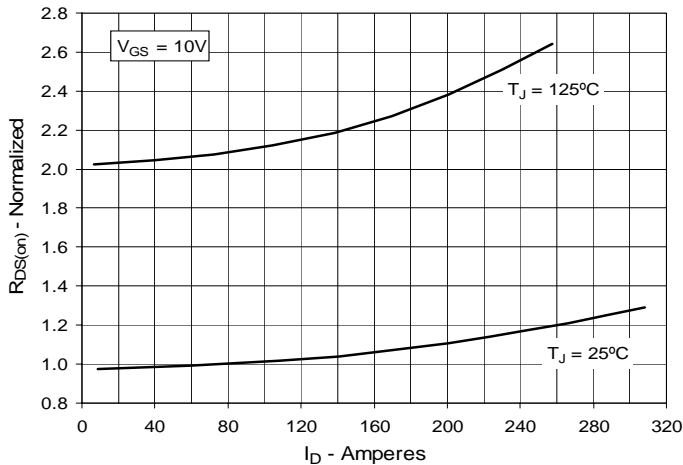

**Fig. 6. Maximum Drain Current vs. Case Temperature**

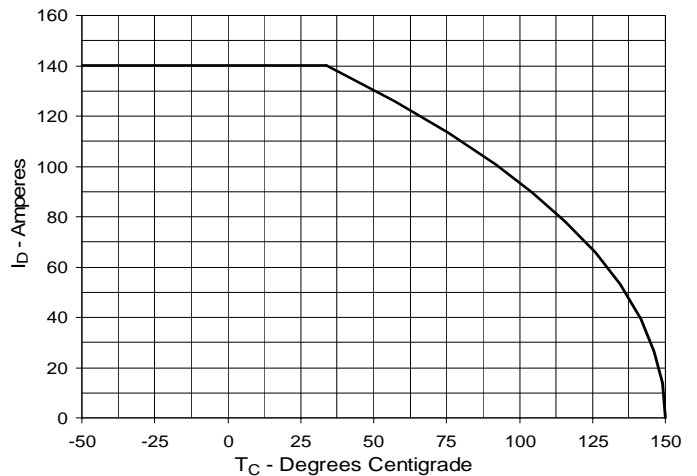

**Fig. 7. Input Admittance**

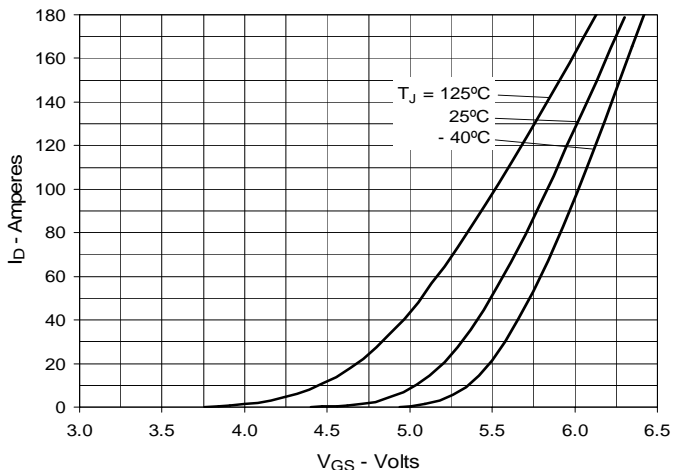

**Fig. 8. Transconductance**

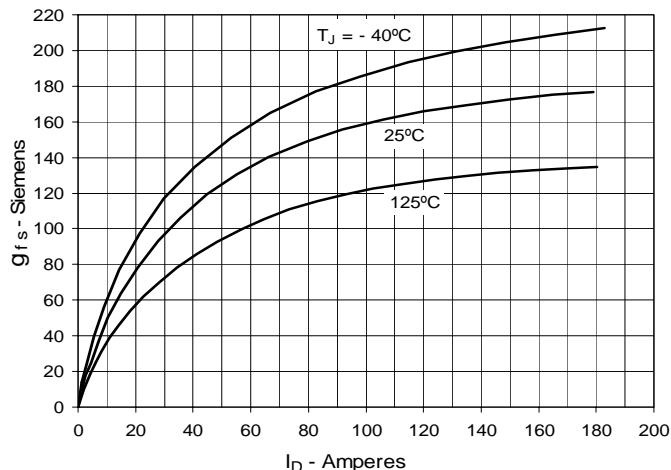

**Fig. 9. Forward Voltage Drop of Intrinsic Diode**

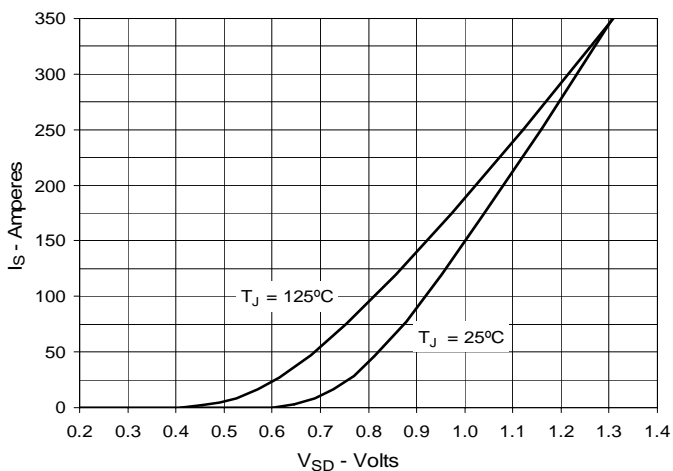

**Fig. 10. Gate Charge**

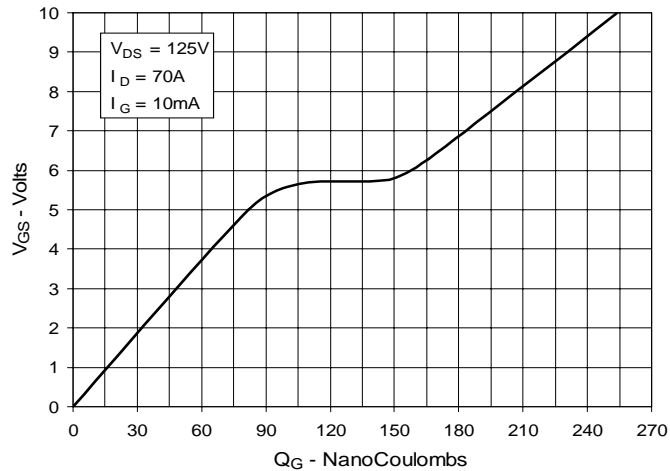

**Fig. 11. Capacitance**

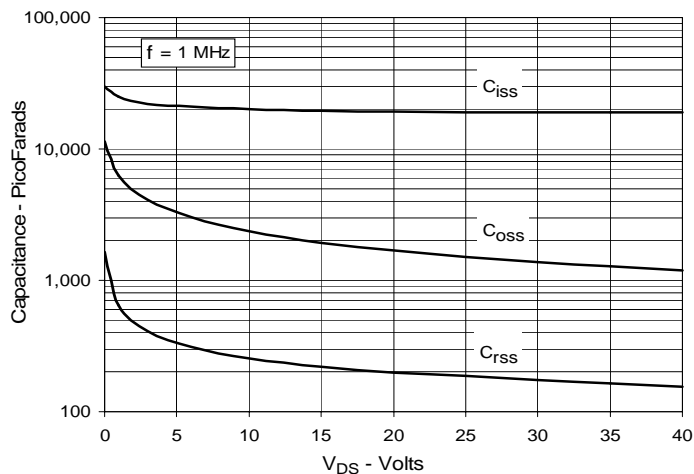

**Fig. 12. Forward-Bias Safe Operating Area**

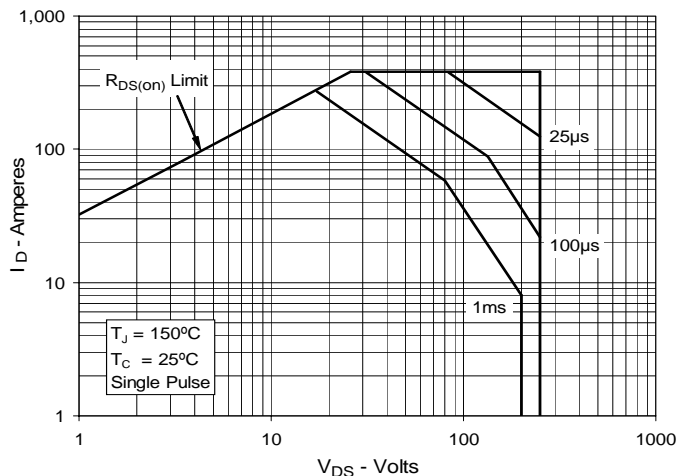
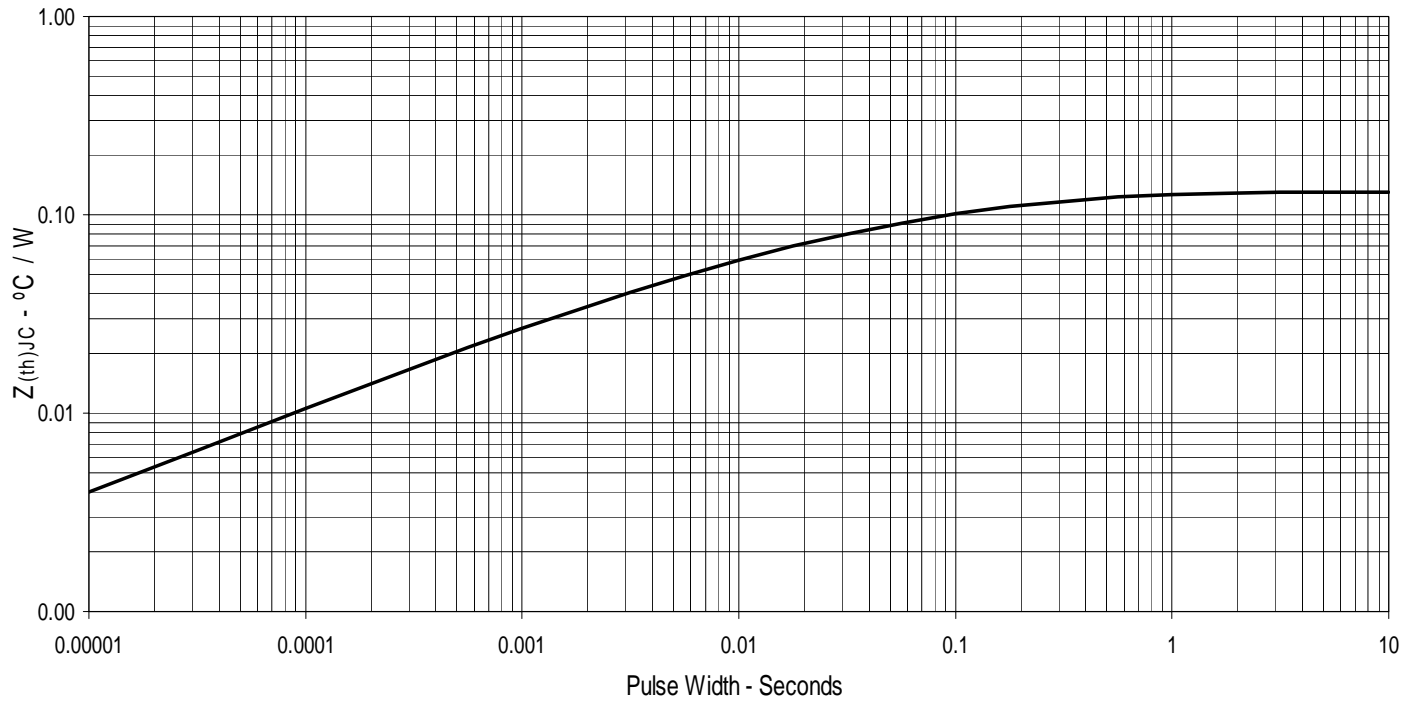

Fig. 13. Maximum Transient Thermal Impedance



# Mouser Electronics

Authorized Distributor

Click to View Pricing, Inventory, Delivery & Lifecycle Information:

[IXYS:](#)

[IXFX140N25T](#) [IXFK140N25T](#)