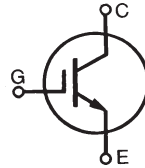

1200V XPT™ IGBTs
GenX3™
IXYK100N120C3
IXYX100N120C3

 High-Speed IGBT
 for 20-50 kHz Switching

$$V_{CES} = 1200V$$

$$I_{C110} = 100A$$

$$V_{CE(sat)} \leq 3.5V$$

$$t_{fi(typ)} = 110ns$$

Symbol	Test Conditions	Maximum Ratings	
V_{CES}	$T_J = 25^\circ C$ to $175^\circ C$	1200	V
V_{CGR}	$T_J = 25^\circ C$ to $175^\circ C$, $R_{GE} = 1M\Omega$	1200	V
V_{GES}	Continuous	± 20	V
V_{GEM}	Transient	± 30	V
I_{C25}	$T_C = 25^\circ C$ (Chip Capability)	188	A
I_{LRMS}	Terminal Current Limit	160	A
I_{C110}	$T_C = 110^\circ C$	100	A
I_{CM}	$T_C = 25^\circ C$, 1ms	490	A
I_A	$T_C = 25^\circ C$	50	A
E_{AS}	$T_C = 25^\circ C$	1.2	J
SSOA (RBSOA)	$V_{GE} = 15V$, $T_{VJ} = 150^\circ C$, $R_G = 1\Omega$ Clamped Inductive Load	$I_{CM} = 200$ @ $V_{CE} \leq V_{CES}$	A
P_C	$T_C = 25^\circ C$	1150	W
T_J		-55 ... +175	$^\circ C$
T_{JM}		175	$^\circ C$
T_{stg}		-55 ... +175	$^\circ C$
T_L	Maximum Lead Temperature for Soldering	300	$^\circ C$
T_{SOLD}	1.6 mm (0.062in.) from Case for 10s	260	$^\circ C$
M_d	Mounting Torque (TO-264)	1.13/10	Nm/lb.in.
F_C	Mounting Force (PLUS247)	20..120 / 4.5..27	N/lb.
Weight	TO-264	10	g
	PLUS247	6	g

Symbol	Test Conditions ($T_J = 25^\circ C$, Unless Otherwise Specified)	Characteristic Values		
		Min.	Typ.	Max.
BV_{CES}	$I_C = 250\mu A$, $V_{GE} = 0V$	1200		V
$V_{GE(th)}$	$I_C = 250\mu A$, $V_{CE} = V_{GE}$	3.0		5.0 V
I_{CES}	$V_{CE} = V_{CES}$, $V_{GE} = 0V$ $T_J = 150^\circ C$			25 μA 1.25 mA
I_{GES}	$V_{CE} = 0V$, $V_{GE} = \pm 20V$			± 100 nA
$V_{CE(sat)}$	$I_C = I_{C110}$, $V_{GE} = 15V$, Note 1 $T_J = 150^\circ C$	2.9 4.1		3.5 V V

TO-264 (IXYK)

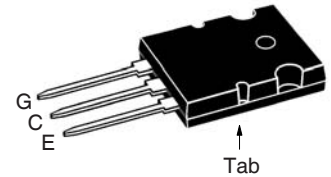

PLUS247 (IXYX)

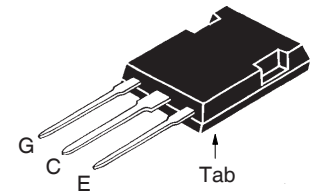

G = Gate E = Emitter
 C = Collector Tab = Collector

Features

- Optimized for Low Switching Losses
- Square RBSOA
- Positive Thermal Coefficient of $V_{ce(sat)}$
- Avalanche Rated
- High Current Handling Capability
- International Standard Packages

Advantages

- High Power Density
- Low Gate Drive Requirement

Applications

- High Frequency Power Inverters
- UPS
- Motor Drives
- SMPS
- PFC Circuits
- Battery Chargers
- Welding Machines
- Lamp Ballasts

Symbol Test Conditions ($T_J = 25^\circ\text{C}$ Unless Otherwise Specified)		Characteristic Values		
		Min.	Typ.	Max.
g_{fs}	$I_C = 60\text{A}, V_{CE} = 10\text{V}, \text{Note 1}$	30	52	S
C_{ies}	$V_{CE} = 25\text{V}, V_{GE} = 0\text{V}, f = 1\text{MHz}$		6000	pF
C_{oes}			353	pF
C_{res}			130	pF
$Q_{g(on)}$	$I_C = I_{C110}, V_{GE} = 15\text{V}, V_{CE} = 0.5 \cdot V_{CES}$		270	nC
Q_{ge}			50	nC
Q_{gc}			93	nC
$t_{d(on)}$	Inductive load, $T_J = 25^\circ\text{C}$ $I_C = I_{C110}, V_{GE} = 15\text{V}$ $V_{CE} = 0.5 \cdot V_{CES}, R_G = 1\Omega$ Note 2		32	ns
t_{ri}			90	ns
E_{on}			6.50	mJ
$t_{d(off)}$			123	ns
t_{fi}			110	ns
E_{off}		2.90	5.00	mJ
$t_{d(on)}$	Inductive load, $T_J = 125^\circ\text{C}$ $I_C = I_{C110}, V_{GE} = 15\text{V}$ $V_{CE} = 0.5 \cdot V_{CES}, R_G = 1\Omega$ Note 2		32	ns
t_{ri}			90	ns
E_{on}			10.10	mJ
$t_{d(off)}$			140	ns
t_{fi}			125	ns
E_{off}		3.55	mJ	
R_{thJC}			0.13	$^\circ\text{C/W}$
R_{thCS}		0.15		$^\circ\text{C/W}$

Notes:

1. Pulse test, $t \leq 300\mu\text{s}$, duty cycle, $d \leq 2\%$.
2. Switching times & energy losses may increase for higher V_{CE} (clamp), T_J or R_G .

PRELIMINARY TECHNICAL INFORMATION

The product presented herein is under development. The Technical Specifications offered are derived from a subjective evaluation of the design, based upon prior knowledge and experience, and constitute a "considered reflection" of the anticipated result. IXYS reserves the right to change limits, test conditions, and dimensions without notice.

TO-264 Outline

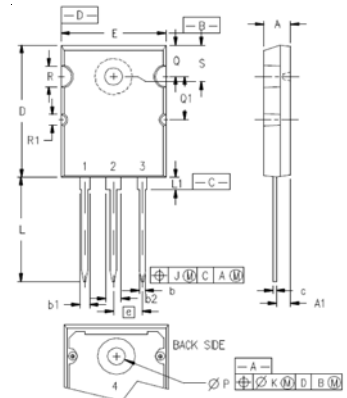

Terminals: 1 = Gate
2,4 = Collector
3 = Emitter

SYM	INCHES		MILLIMETERS	
	MIN	MAX	MIN	MAX
A	.185	.209	4.70	5.31
A1	.102	.118	2.59	3.00
b	.037	.055	0.94	1.40
b1	.087	.102	2.21	2.59
b2	.110	.126	2.79	3.20
c	.017	.029	0.43	0.74
D	1.007	1.047	25.58	26.59
E	.760	.799	19.30	20.29
e	.215 BSC		5.46 BSC	
J	.000	.010	0.00	0.25
K	.000	.010	0.00	0.25
L	.779	.842	19.79	21.39
L1	.087	.102	2.21	2.59
ØP	.122	.138	3.10	3.51
Q	.240	.256	6.10	6.50
Q1	.330	.346	8.38	8.79
ØR	.155	.187	3.94	4.75
ØR1	.085	.093	2.16	2.36
S	.243	.253	6.17	6.43

PLUS247™ Outline

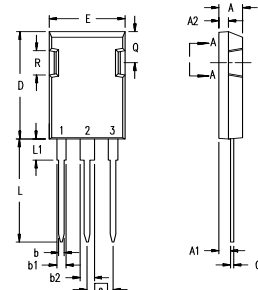

Terminals: 1 - Gate
2 - Collector
3 - Emitter

Dim.	Millimeter		Inches	
	Min.	Max.	Min.	Max.
A	4.83	5.21	.190	.205
A ₁	2.29	2.54	.090	.100
A ₂	1.91	2.16	.075	.085
b	1.14	1.40	.045	.055
b ₁	1.91	2.13	.075	.084
b ₂	2.92	3.12	.115	.123
C	0.61	0.80	.024	.031
D	20.80	21.34	.819	.840
E	15.75	16.13	.620	.635
e	5.45 BSC		.215 BSC	
L	19.81	20.32	.780	.800
L1	3.81	4.32	.150	.170
Q	5.59	6.20	.220	0.244
R	4.32	4.83	.170	.190

IXYS Reserves the Right to Change Limits, Test Conditions, and Dimensions.

IXYS MOSFETs and IGBTs are covered by one or more of the following U.S. patents:	4,835,592	4,931,844	5,049,961	5,237,481	6,162,665	6,404,065 B1	6,683,344	6,727,585	7,005,734 B2	7,157,338B2
	4,860,072	5,017,508	5,063,307	5,381,025	6,259,123 B1	6,534,343	6,710,405 B2	6,759,692	7,063,975 B2	
	4,881,106	5,034,796	5,187,117	5,486,715	6,306,728 B1	6,583,505	6,710,463	6,771,478 B2	7,071,537	

Fig. 1. Output Characteristics @ $T_J = 25^\circ\text{C}$

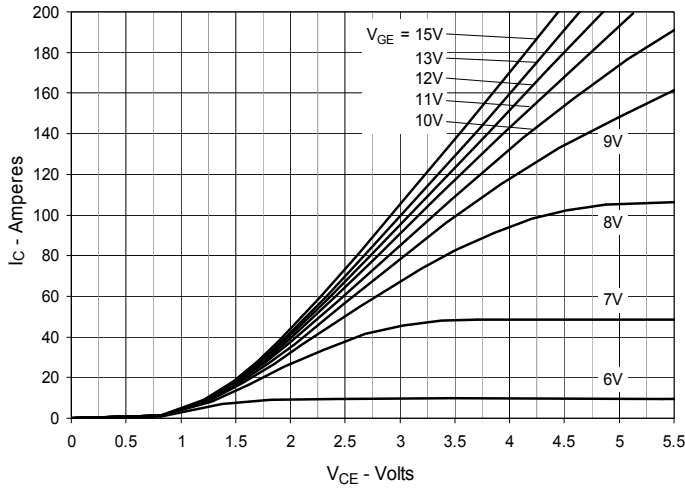

Fig. 2. Extended Output Characteristics @ $T_J = 25^\circ\text{C}$

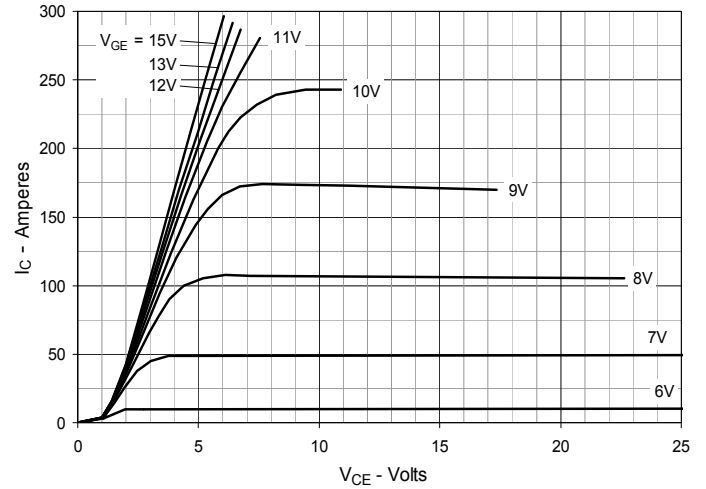

Fig. 3. Output Characteristics @ $T_J = 125^\circ\text{C}$

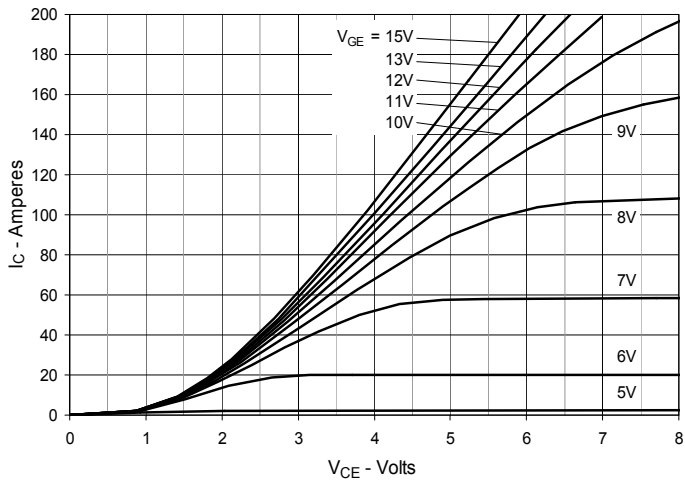

Fig. 4. Dependence of $V_{CE(sat)}$ on Junction Temperature

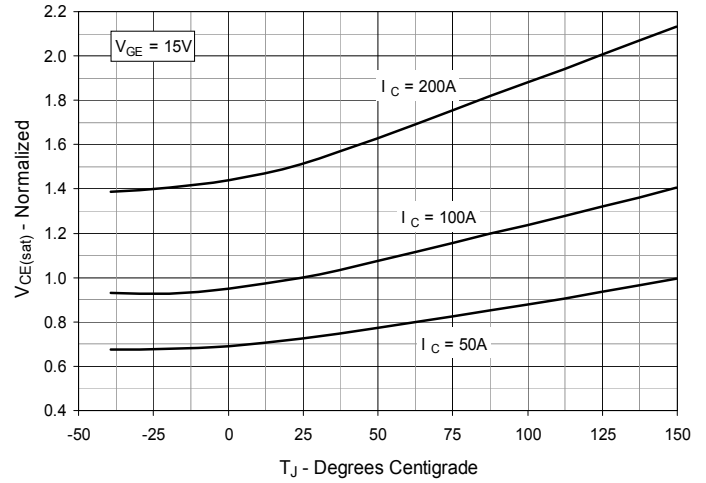

Fig. 5. Collector-to-Emitter Voltage vs. Gate-to-Emitter Voltage

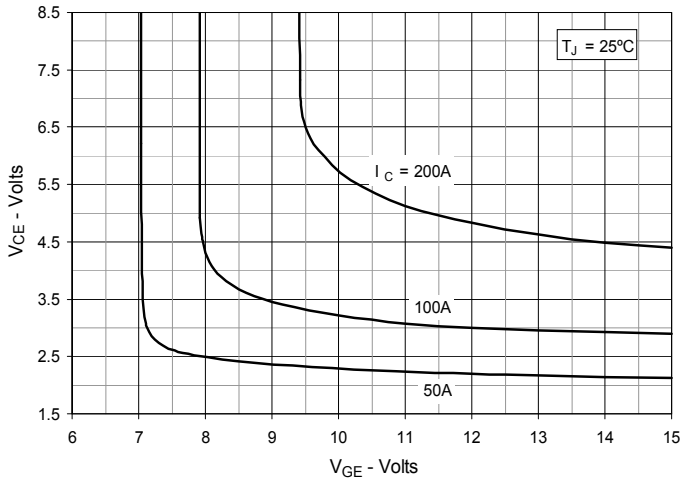

Fig. 6. Input Admittance

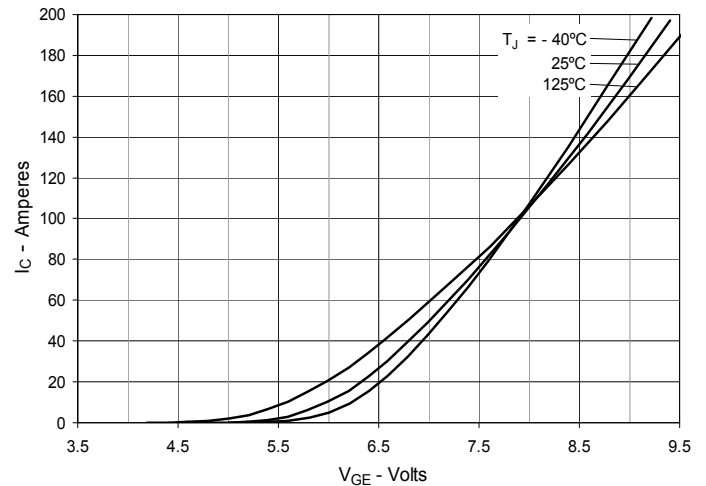

Fig. 7. Transconductance

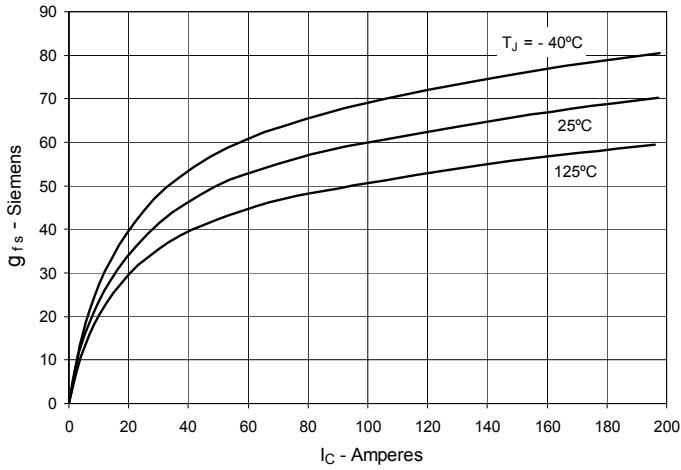

Fig. 8. Gate Charge

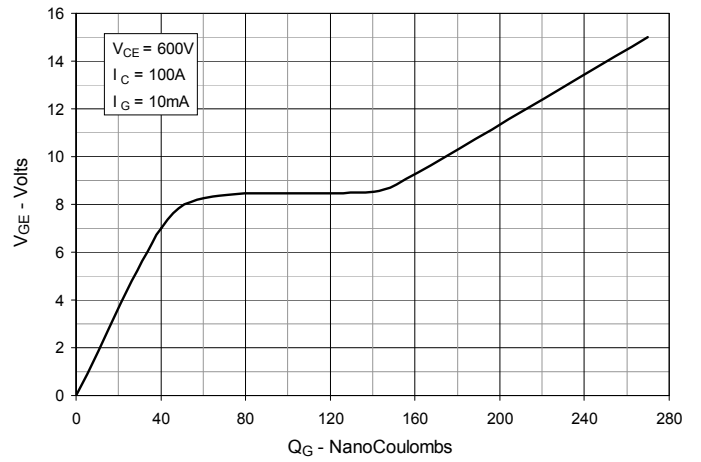

Fig. 9. Capacitance

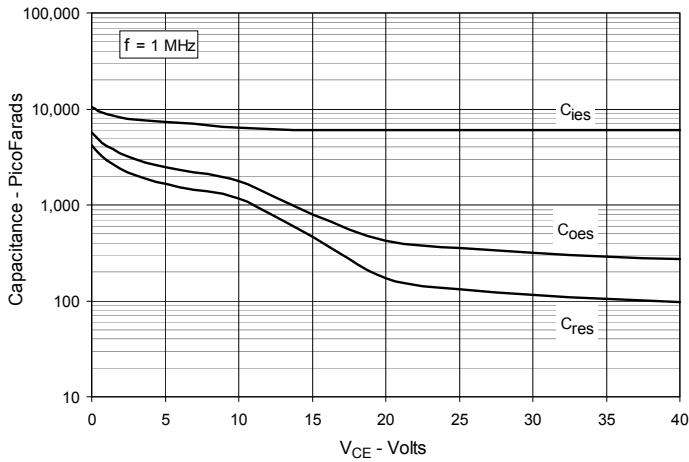

Fig. 10. Reverse-Bias Safe Operating Area

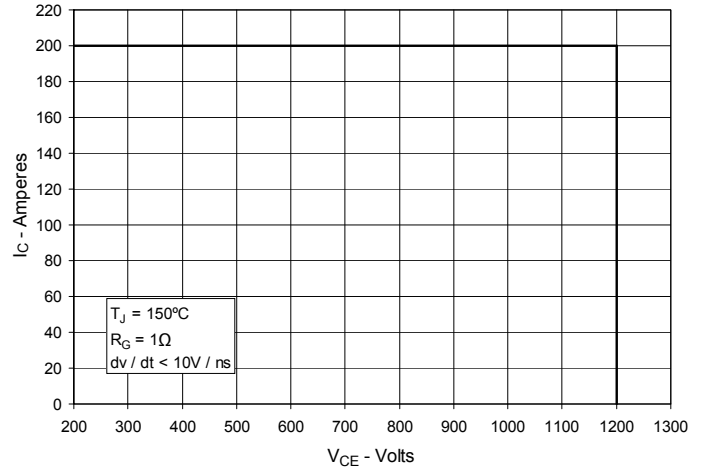

Fig. 11. Maximum Transient Thermal Impedance

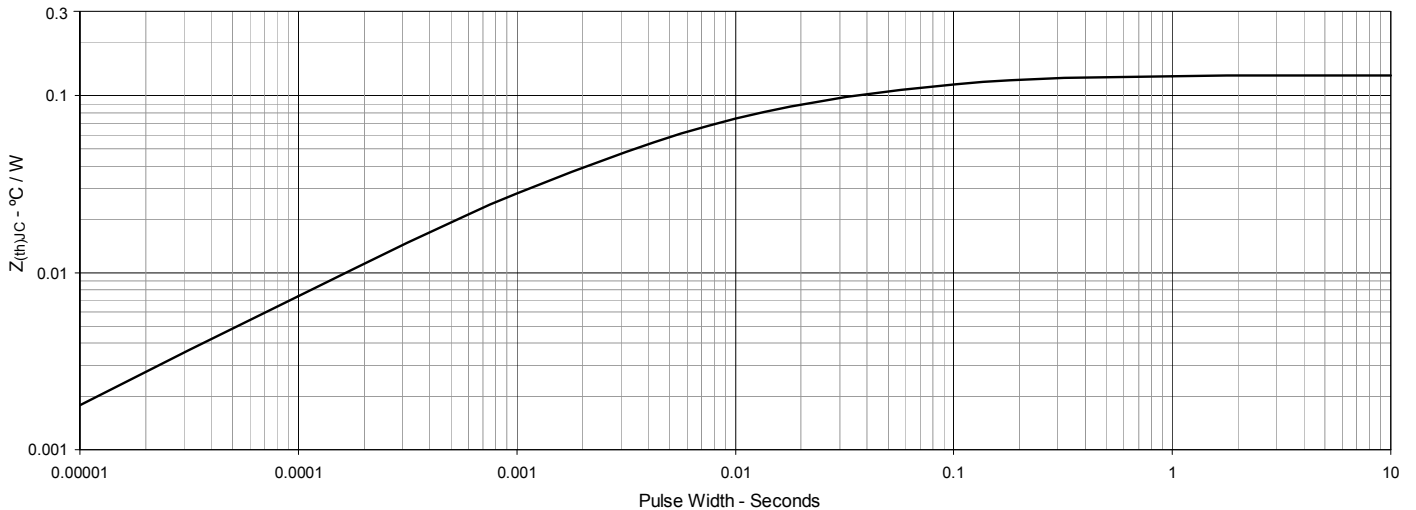

Fig. 12. Inductive Switching Energy Loss vs. Gate Resistance

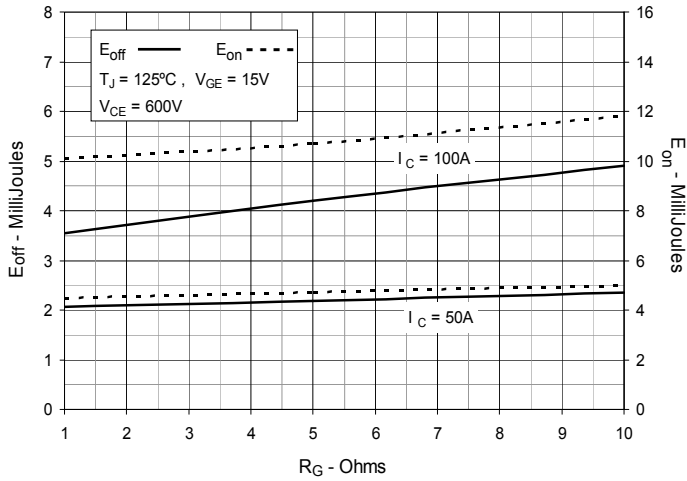

Fig. 13. Inductive Switching Energy Loss vs. Collector Current

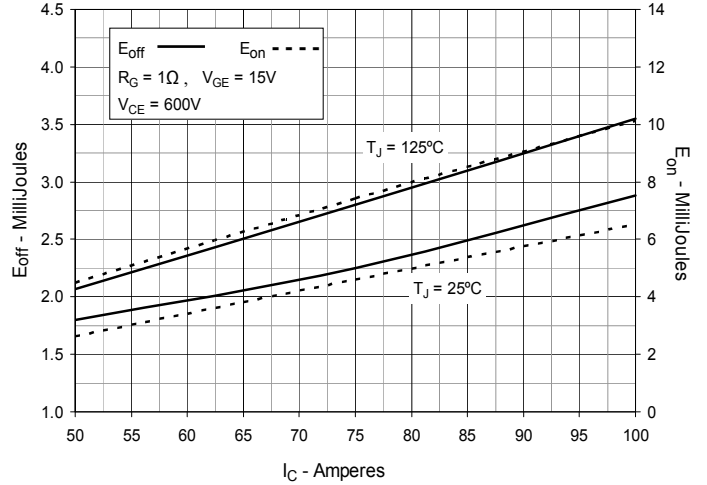

Fig. 14. Inductive Switching Energy Loss vs. Junction Temperature

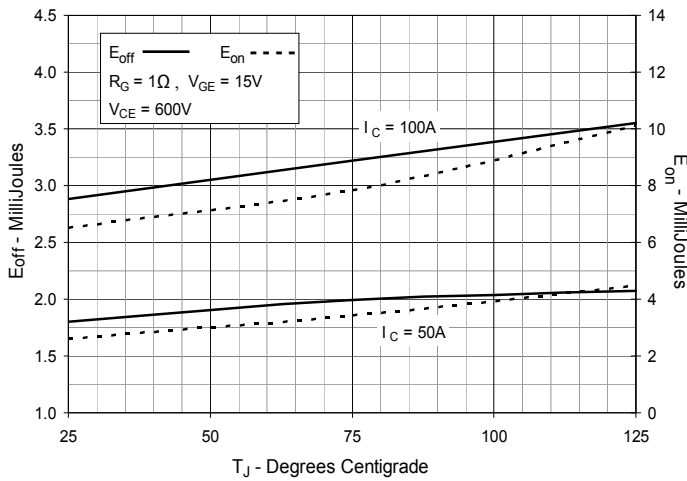

Fig. 15. Inductive Turn-off Switching Times vs. Gate Resistance

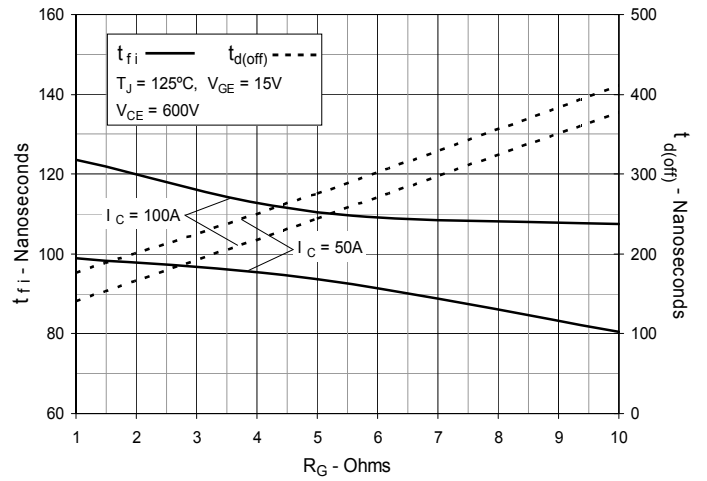

Fig. 16. Inductive Turn-off Switching Times vs. Collector Current

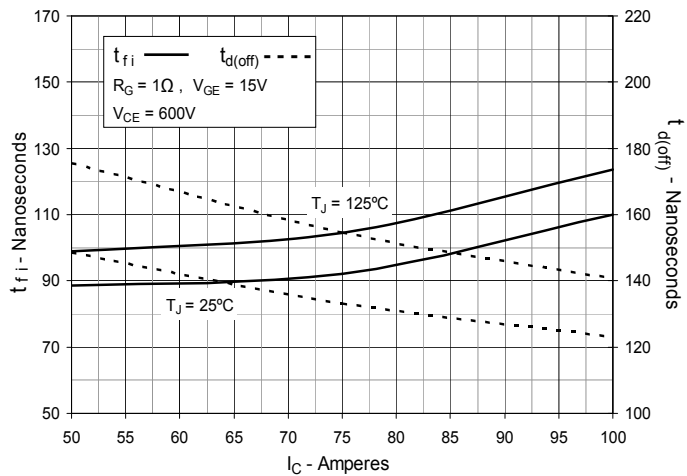

Fig. 17. Inductive Turn-off Switching Times vs. Junction Temperature

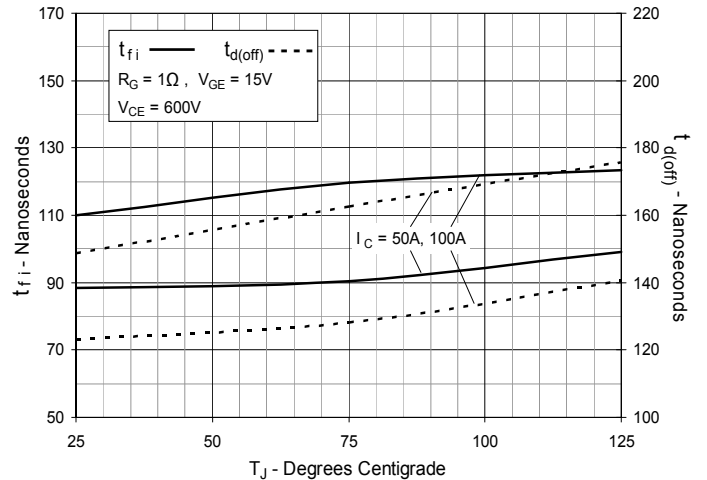

Fig. 18. Inductive Turn-on Switching Times vs. Gate Resistance

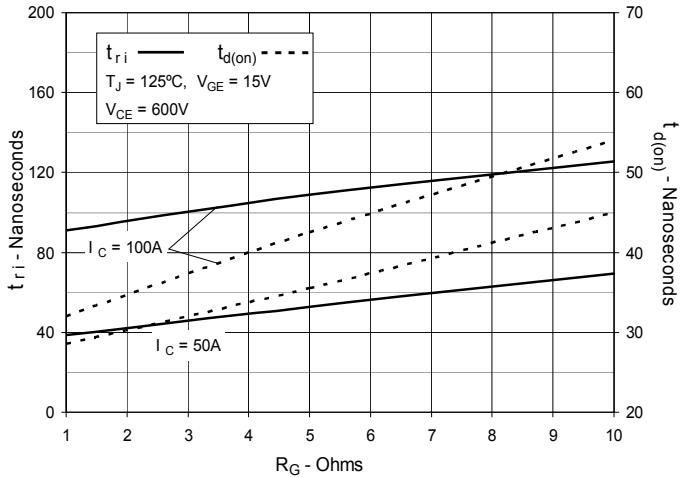

Fig. 19. Inductive Turn-on Switching Times vs. Collector Current

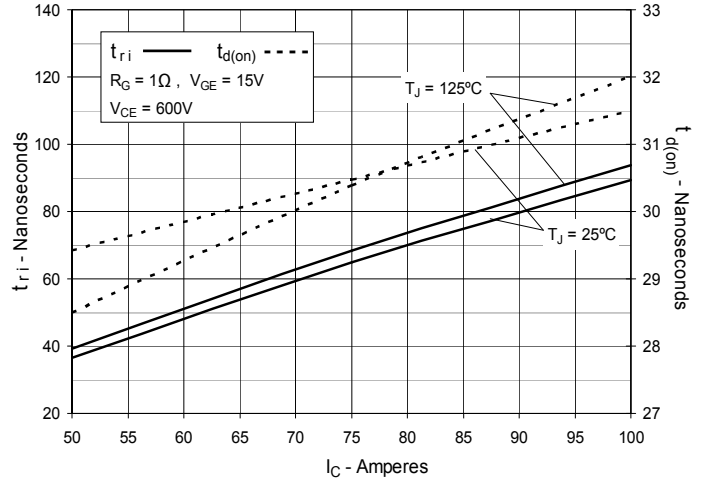
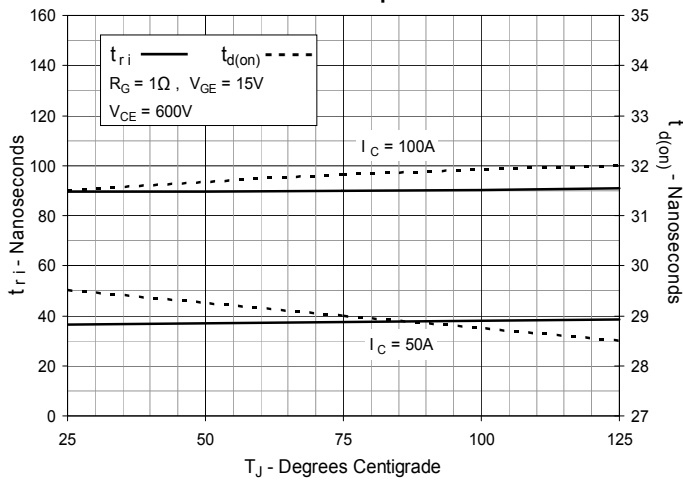

Fig. 20. Inductive Turn-on Switching Times vs. Junction Temperature



Mouser Electronics

Authorized Distributor

Click to View Pricing, Inventory, Delivery & Lifecycle Information:

[IXYS:](#)

[IXYX100N120C3](#)