

**X-Class HiPerFET™
Power MOSFET**
**IXFA20N85XHV
IXFP20N85X
IXFH20N85X**
 $V_{DSS} = 850V$
 $I_{D25} = 20A$
 $R_{DS(on)} \leq 330m\Omega$

 N-Channel Enhancement Mode
 Avalanche Rated
 Fast Intrinsic Diode

Symbol	Test Conditions	Maximum Ratings	
V_{DSS}	$T_J = 25^\circ C$ to $150^\circ C$	850	V
V_{DGR}	$T_J = 25^\circ C$ to $150^\circ C$, $R_{GS} = 1M\Omega$	850	V
V_{GSS}	Continuous	± 30	V
V_{GSM}	Transient	± 40	V
I_{D25}	$T_C = 25^\circ C$	20	A
I_{DM}	$T_C = 25^\circ C$, Pulse Width Limited by T_{JM}	40	A
I_A	$T_C = 25^\circ C$	10	A
E_{AS}	$T_C = 25^\circ C$	800	mJ
dv/dt	$I_S \leq I_{DM}$, $V_{DD} \leq V_{DSS}$, $T_J \leq 150^\circ C$	50	V/ns
P_D	$T_C = 25^\circ C$	540	W
T_J		-55 ... +150	$^\circ C$
T_{JM}		150	$^\circ C$
T_{stg}		-55 ... +150	$^\circ C$
T_L	Maximum Lead Temperature for Soldering	300	$^\circ C$
T_{SOLD}	1.6 mm (0.062in.) from Case for 10s	260	$^\circ C$
F_C	Mounting Force (TO-263HV)	10.65 / 2.2..14.6	N/lb
M_d	Mounting Torque (TO-220 & TO-247)	1.13 / 10	Nm/lb.in
Weight	TO-263HV	2.5	g
	TO-220	3.0	g
	TO-247	6.0	g

TO-263HV

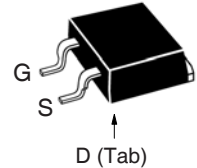

TO-220AB (IXFP)

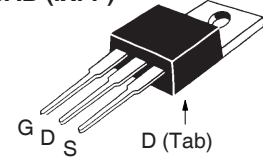

TO-247 (IXFH)

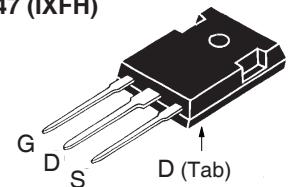
 G = Gate D = Drain
 S = Source Tab = Drain

Features

- International Standard Packages
- High Voltage Package
- Low $R_{DS(ON)}$ and Q_G
- Avalanche Rated
- Low Package Inductance

Advantages

- High Power Density
- Easy to Mount
- Space Savings

Applications

- Switch-Mode and Resonant-Mode Power Supplies
- DC-DC Converters
- PFC Circuits
- AC and DC Motor Drives
- Robotics and Servo Controls

Symbol	Test Conditions ($T_J = 25^\circ C$, Unless Otherwise Specified)	Characteristic Values		
		Min.	Typ.	Max.
BV_{DSS}	$V_{GS} = 0V$, $I_D = 1mA$	850		V
$V_{GS(th)}$	$V_{DS} = V_{GS}$, $I_D = 2.5mA$	3.5		5.5 V
I_{GSS}	$V_{GS} = \pm 30V$, $V_{DS} = 0V$			± 100 nA
I_{DSS}	$V_{DS} = V_{DSS}$, $V_{GS} = 0V$ $T_J = 125^\circ C$			25 μA 1.5 mA
$R_{DS(on)}$	$V_{GS} = 10V$, $I_D = 0.5 \cdot I_{D25}$, Note 1			330 m Ω

Symbol	Test Conditions ($T_J = 25^\circ\text{C}$, Unless Otherwise Specified)	Characteristic Values		
		Min.	Typ.	Max
g_{fs}	$V_{DS} = 10\text{V}$, $I_D = 0.5 \cdot I_{D25}$, Note 1	6	10	S
R_{Gi}	Gate Input Resistance		0.80	Ω
C_{iss}	$V_{GS} = 0\text{V}$, $V_{DS} = 25\text{V}$, $f = 1\text{MHz}$		1660	pF
C_{oss}			1730	pF
C_{rss}			24	pF
$t_{d(on)}$	Resistive Switching Times $V_{GS} = 10\text{V}$, $V_{DS} = 0.5 \cdot V_{DSS}$, $I_D = 0.5 \cdot I_{D25}$ $R_G = 5\Omega$ (External)		20	ns
t_r			28	ns
$t_{d(off)}$			44	ns
t_f			20	ns
$Q_{g(on)}$	$V_{GS} = 10\text{V}$, $V_{DS} = 0.5 \cdot V_{DSS}$, $I_D = 0.5 \cdot I_{D25}$		63	nC
Q_{gs}			12	nC
Q_{gd}			26	nC
R_{thJC}				0.23 $^\circ\text{C/W}$
R_{thCS}	TO-220		0.50	$^\circ\text{C/W}$
	TO-247		0.21	$^\circ\text{C/W}$

Source-Drain Diode

Symbol	Test Conditions ($T_J = 25^\circ\text{C}$, Unless Otherwise Specified)	Characteristic Values		
		Min.	Typ.	Max
I_S	$V_{GS} = 0\text{V}$			20 A
I_{SM}	Repetitive, pulse Width Limited by T_{JM}			80 A
V_{SD}	$I_F = I_S$, $V_{GS} = 0\text{V}$, Note 1			1.4 V
t_{rr}	$I_F = 20\text{A}$, $-di/dt = 100\text{A}/\mu\text{s}$ $V_R = 100\text{V}$		190	ns
Q_{RM}			1.6	μC
I_{RM}			16.5	A

Note 1. Pulse test, $t \leq 300\mu\text{s}$, duty cycle, $d \leq 2\%$.

PRELIMINARY TECHNICAL INFORMATION

The product presented herein is under development. The Technical Specifications offered are derived from a subjective evaluation of the design, based upon prior knowledge and experience, and constitute a "considered reflection" of the anticipated result. IXYS reserves the right to change limits, test conditions, and dimensions without notice.

IXYS Reserves the Right to Change Limits, Test Conditions, and Dimensions.

IXYS MOSFETs and IGBTs are covered	4,835,592	4,931,844	5,049,961	5,237,481	6,162,665	6,404,065B1	6,683,344	6,727,585	7,005,734B2	7,157,338B2
by one or more of the following U.S. patents:	4,860,072	5,017,508	5,063,307	5,381,025	6,259,123B1	6,534,343	6,710,405B2	6,759,692	7,063,975B2	
	4,881,106	5,034,796	5,187,117	5,486,715	6,306,728B1	6,583,505	6,710,463	6,771,478B2	7,071,537	

Fig. 1. Output Characteristics @ $T_J = 25^\circ\text{C}$

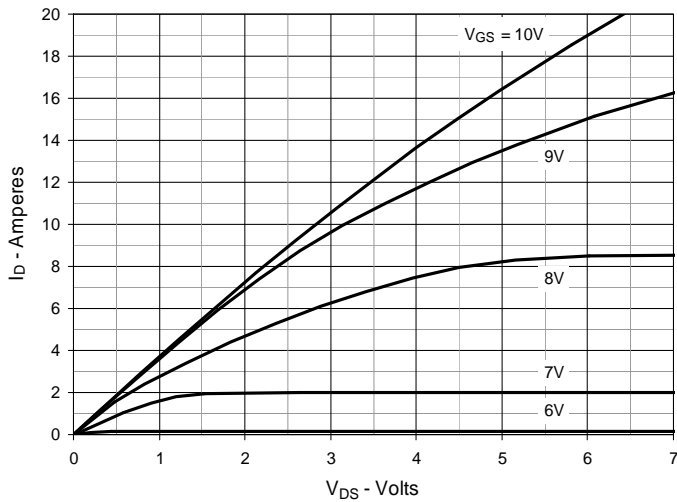

Fig. 2. Extended Output Characteristics @ $T_J = 25^\circ\text{C}$

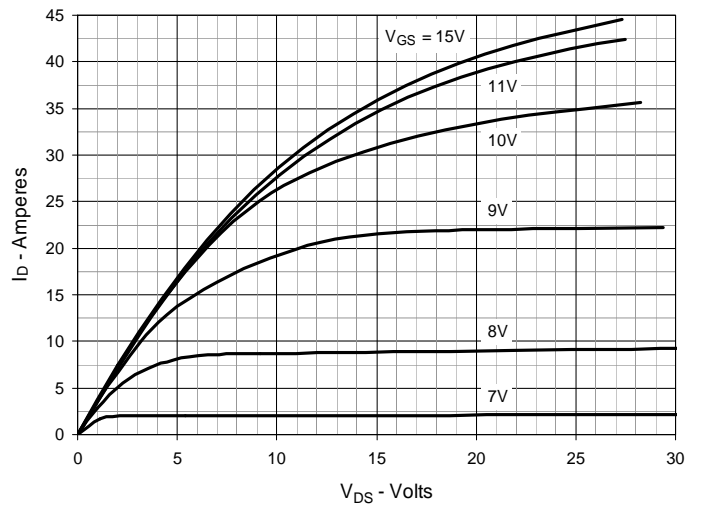

Fig. 3. Output Characteristics @ $T_J = 125^\circ\text{C}$

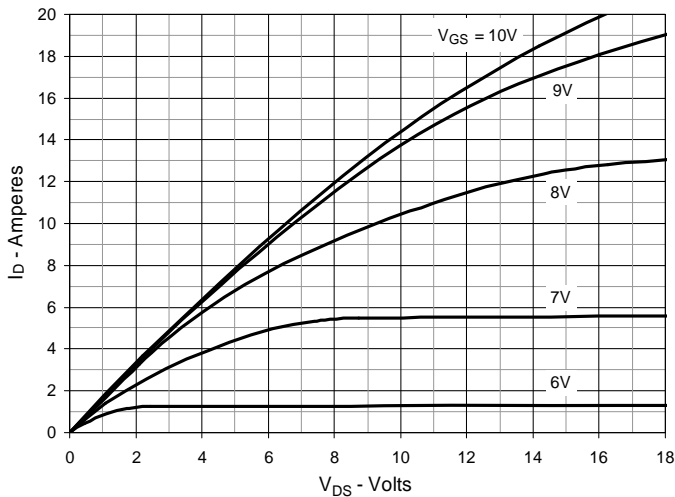

Fig. 4. $R_{DS(on)}$ Normalized to $I_D = 10\text{A}$ Value vs. Junction Temperature

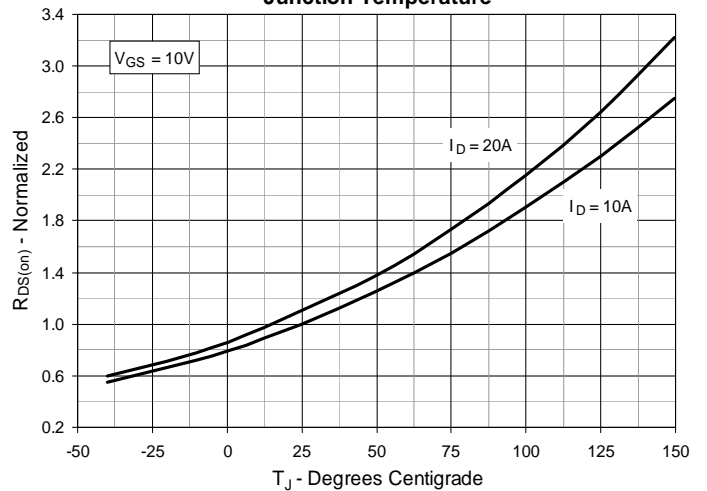

Fig. 5. $R_{DS(on)}$ Normalized to $I_D = 10\text{A}$ Value vs. Drain Current

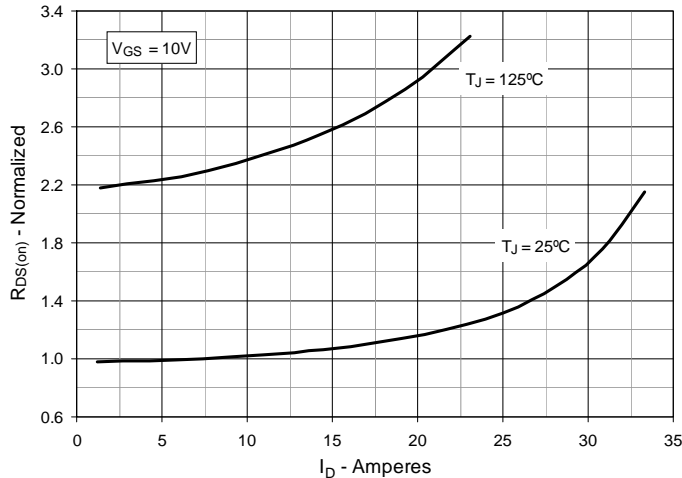

Fig. 6. Normalized Breakdown & Threshold Voltages vs. Junction Temperature

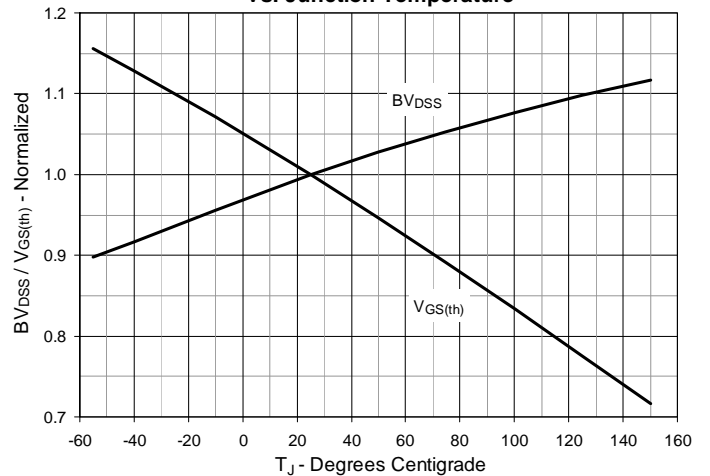

Fig. 7. Maximum Drain Current vs. Case Temperature

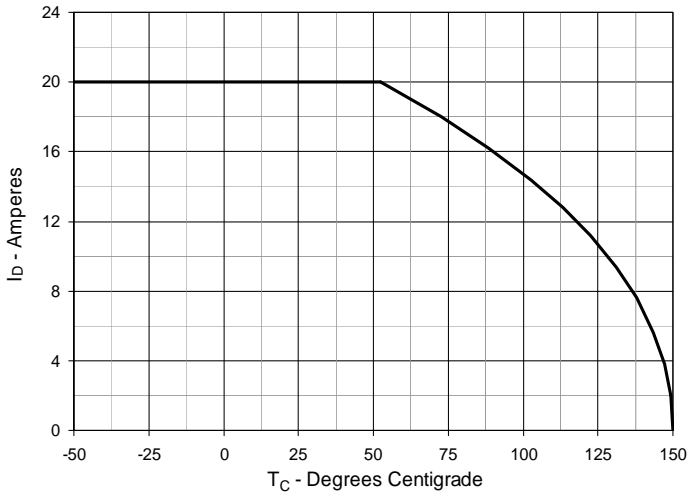

Fig. 8. Input Admittance

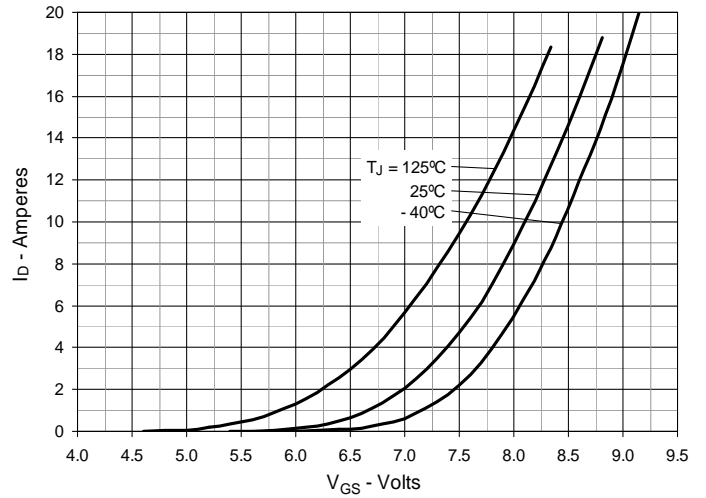

Fig. 9. Transconductance

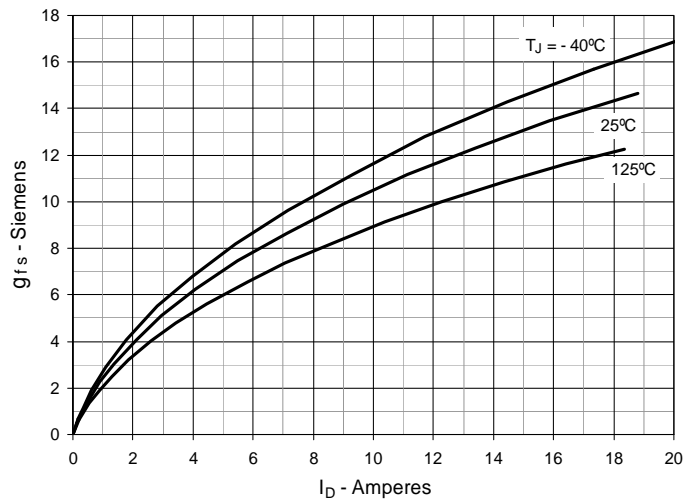

Fig. 10. Forward Voltage Drop of Intrinsic Diode

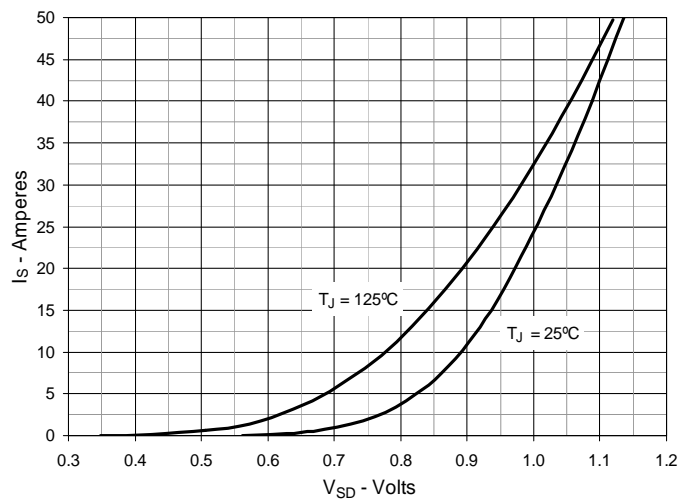

Fig. 11. Gate Charge

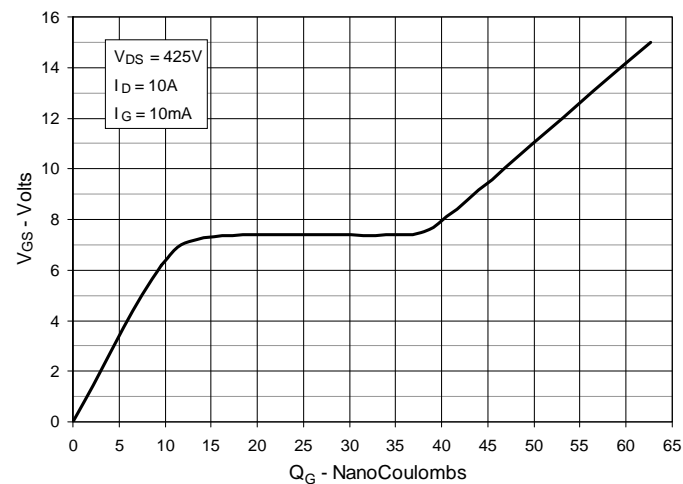

Fig. 12. Capacitance

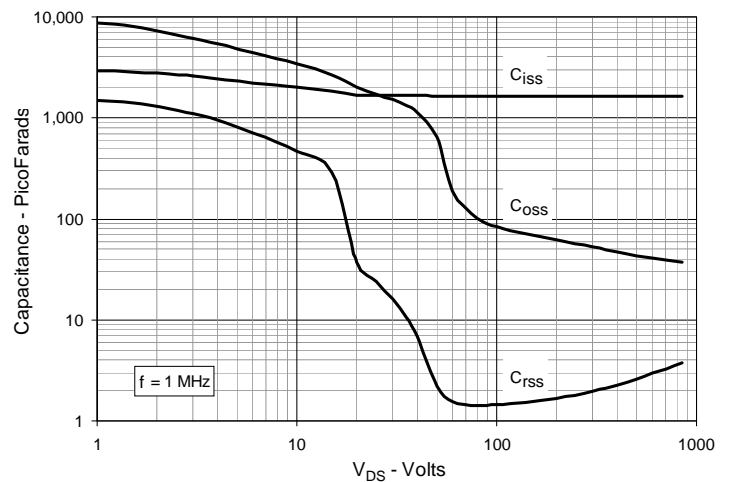

Fig. 13. Output Capacitance Stored Energy

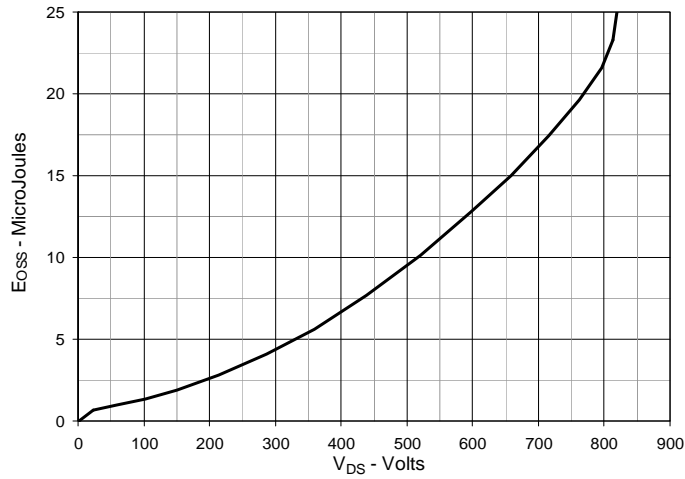

Fig. 14. Forward-Bias Safe Operating Area

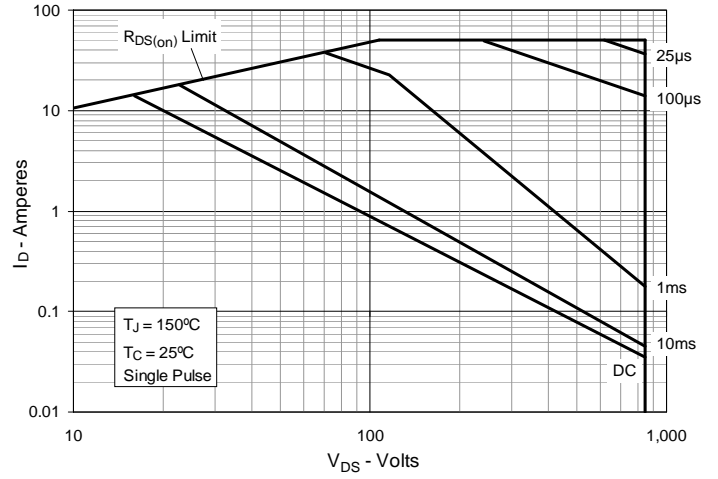
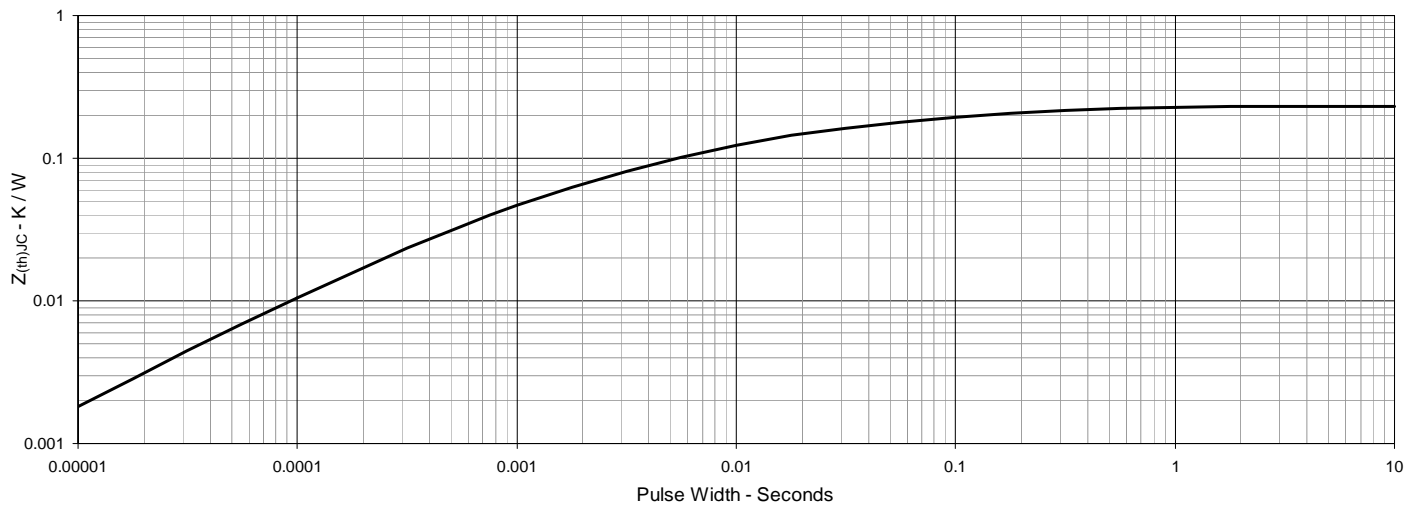
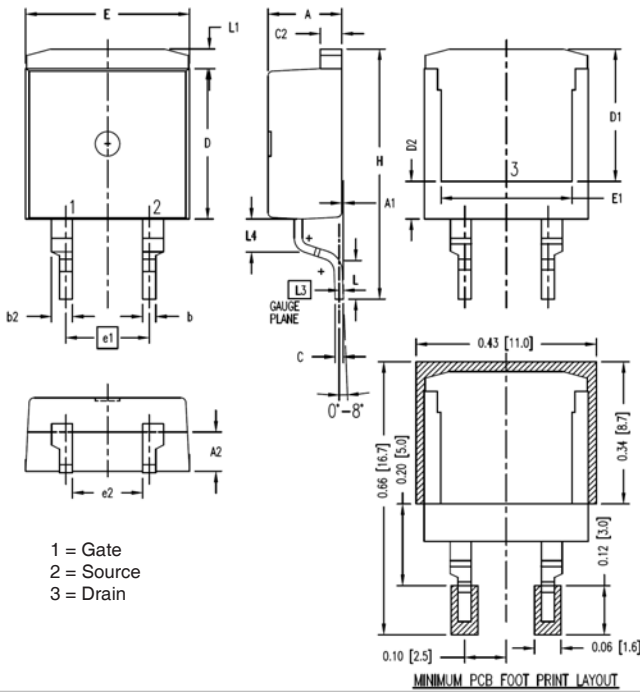

Fig. 15. Maximum Transient Thermal Impedance



TO-263HV Outline



SYM	INCHES		MILLIMETER	
	MIN	MAX	MIN	MAX
A	.170	.185	4.30	4.70
A1	.000	.008	0.00	0.20
A2	.091	.098	2.30	2.50
b	.028	.035	0.70	0.90
b2	.046	.054	1.18	1.38
C	.018	.024	0.45	0.60
C2	.049	.055	1.25	1.40
D	.354	.370	9.00	9.40
D1	.311	.327	7.90	8.30
D2	.083	.098	2.10	2.50
E	.386	.402	9.80	10.20
E1	.307	.323	7.80	8.20
e1	.200 BSC		5.08 BSC	
(e2)	.163	.174	4.13	4.43
H	.591	.614	15.00	15.60
L	.079	.102	2.00	2.60
L1	.039	.055	1.00	1.40
L3	.010 BSC		0.254 BSC	
(L4)	.071	.087	1.80	2.20

TO-220 Outline

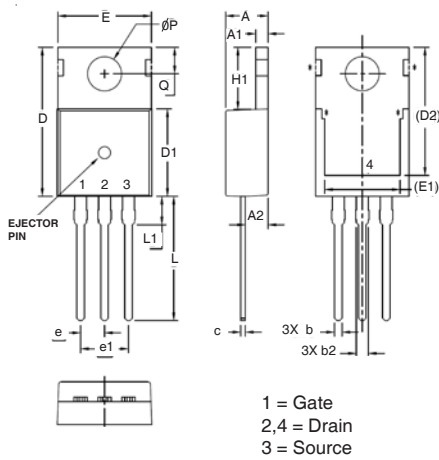

SYM	INCHES		MILLIMETERS	
	MIN	MAX	MIN	MAX
A	.169	.185	4.30	4.70
A1	.047	.055	1.20	1.40
A2	.079	.106	2.00	2.70
b	.024	.039	0.60	1.00
b2	.045	.057	1.15	1.45
c	.014	.026	0.35	0.65
D	.587	.626	14.90	15.90
D1	.335	.370	8.50	9.40
(D2)	.500	.531	12.70	13.50
E	.382	.406	9.70	10.30
(E1)	.283	.323	7.20	8.20
e	.100 BSC		2.54 BSC	
e1	.200 BSC		5.08 BSC	
H1	.244	.268	6.20	6.80
L	.492	.547	12.50	13.90
L1	.110	.154	2.80	3.90
ØP	.134	.150	3.40	3.80
Q	.106	.126	2.70	3.20

TO-247 Outline

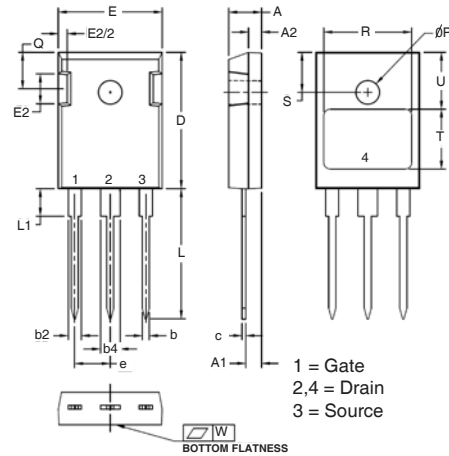

SYM	INCHES		MILLIMETERS	
	MIN	MAX	MIN	MAX
A	.190	.205	4.83	5.21
A1	.087	.100	2.21	2.54
A2	.075	.085	1.91	2.16
b	.045	.055	1.14	1.40
b2	.075	.085	1.91	2.16
b4	.115	.126	2.92	3.20
c	.023	.033	0.58	0.84
D	.820	.840	20.83	21.34
E	.620	.635	15.75	16.13
E2	.175	.195	4.44	4.95
e	.215 BSC		5.45 BSC	
L	.780	.810	19.81	20.57
L1	.160	.177	4.06	4.50
Q	.220	.240	5.59	6.10
R	.520	.540	13.21	13.72
S	.242 BSC		6.15 BSC	
T	.355	.375	9.02	9.53
U	.345	.370	8.76	9.40
ØP	.140	.144	3.55	3.66
W	.000	.004	0.00	0.10

Mouser Electronics

Authorized Distributor

Click to View Pricing, Inventory, Delivery & Lifecycle Information:

[IXYS:](#)

[IXFP20N85X](#) [IXFH20N85X](#) [IXFA20N85XHV](#)