

PolarHV™ HiPerFET Power MOSFET

IXFH12N80P
IXFQ12N80P
IXFV12N80P
IXFV12N80PS

$V_{DSS} = 800 \text{ V}$
 $I_{D25} = 12 \text{ A}$
 $R_{DS(on)} \leq 0.85 \text{ } \Omega$
 $t_{rr} \leq 250 \text{ ns}$

N-Channel Enhancement Mode

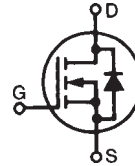

Symbol	Test Conditions	Maximum Ratings	
V_{DSS}	$T_J = 25^\circ\text{C to } 150^\circ\text{C}$	800	V
V_{DGR}	$T_J = 25^\circ\text{C to } 150^\circ\text{C}; R_{GS} = 1 \text{ M}\Omega$	800	V
V_{GS}	Continuous	± 30	V
V_{GSM}	Transient	± 40	V
I_{D25}	$T_C = 25^\circ\text{C}$	12	A
I_{DM}	$T_C = 25^\circ\text{C}$, pulse width limited by T_{JM}	36	A
I_{AR}	$T_C = 25^\circ\text{C}$	6	A
E_{AR}	$T_C = 25^\circ\text{C}$	30	mJ
E_{AS}	$T_C = 25^\circ\text{C}$	0.8	J
dv/dt	$I_S \leq I_{DM}$, $di/dt \leq 100 \text{ A}/\mu\text{s}$, $V_{DD} \leq V_{DSS}$, $T_J \leq 150^\circ\text{C}$, $R_G = 5 \text{ } \Omega$	10	V/ns
P_D	$T_C = 25^\circ\text{C}$	360	W
T_J		-55 ... +150	$^\circ\text{C}$
T_{JM}		150	$^\circ\text{C}$
T_{stg}		-55 ... +150	$^\circ\text{C}$
T_L	1.6 mm (0.062 in.) from case for 10 s	300	$^\circ\text{C}$
T_{SOLD}	Plastic body for 10 s	260	$^\circ\text{C}$
M_d	Mounting torque (TO-247, TO-3P)	1.13/10	Nm/lb.in.
F_C	Mounting force (PLUS220, PLUS220SMD)	11..65/2.5..15	N/lb.
Weight	PLUS220 & PLUS220SMD	4.0	g
	TO-3P	5.5	g
	TO-247	6.0	g

TO-247 (IXFH)

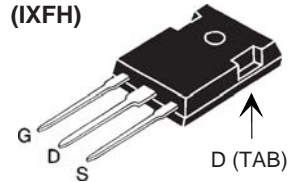

TO-3P (IXFQ)

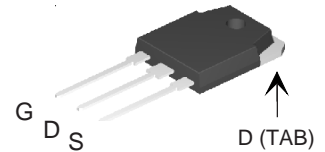

PLUS220 (IXFV)

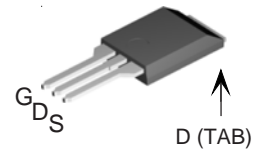

PLUS220 SMD (IXFV...S)

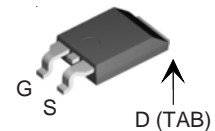

G = Gate D = Drain
S = Source TAB = Drain

Features

- International standard packages
- Unclamped Inductive Switching (UIS) rated
- Low package inductance
 - easy to drive and to protect

Advantages

- Easy to mount
- Space savings
- High power density

Symbol	Test Conditions	Characteristic Values		
		Min.	Typ.	Max.
BV_{DSS}	$V_{GS} = 0 \text{ V}$, $I_D = 250 \text{ } \mu\text{A}$	800		V
$V_{GS(th)}$	$V_{DS} = V_{GS}$, $I_D = 2.5 \text{ mA}$	3.0		5.5 V
I_{GSS}	$V_{GS} = \pm 30 \text{ V}$, $V_{DS} = 0 \text{ V}$			$\pm 100 \text{ nA}$
I_{DSS}	$V_{DS} = V_{DSS}$ $V_{GS} = 0 \text{ V}$ $T_J = 125^\circ\text{C}$			25 μA
				250 μA
$R_{DS(on)}$	$V_{GS} = 10 \text{ V}$, $I_D = 0.5 I_{D25}$, Note 1			0.85 Ω

Symbol	Test Conditions	Characteristic Values		
		$(T_J = 25^\circ\text{C}$ unless otherwise specified)		
		Min.	Typ.	Max.
g_{fs}	$V_{DS} = 20\text{ V}; I_D = 0.5 I_{D25}$, Note 1	8	14	S
C_{iss}	$V_{GS} = 0\text{ V}, V_{DS} = 25\text{ V}, f = 1\text{ MHz}$		2800	pF
C_{oss}			210	pF
C_{rss}			19	pF
$t_{d(on)}$	$V_{GS} = 10\text{ V}, V_{DS} = 0.5 V_{DSS}, I_D = I_{D25}$ $R_G = 5\ \Omega$ (External)		23	ns
t_r			26	ns
$t_{d(off)}$			70	ns
t_f			25	ns
$Q_{g(on)}$	$V_{GS} = 10\text{ V}, V_{DS} = 0.5 V_{DSS}, I_D = 0.5 I_{D25}$		51	nC
Q_{gs}			13	nC
Q_{gd}			19	nC
R_{thJC}	(TO-247 & TO-3P)			0.35 $^\circ\text{C/W}$
R_{thCS}			0.21	$^\circ\text{C/W}$

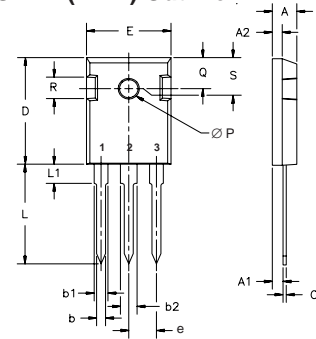
TO-247 (IXFH) Outline

 Terminals: 1 - Gate 2 - Drain
 3 - Source Tab - Drain

Dim.	Millimeter		Inches	
	Min.	Max.	Min.	Max.
A	4.7	5.3	.185	.209
A ₁	2.2	2.54	.087	.102
A ₂	2.2	2.6	.059	.098
b	1.0	1.4	.040	.055
b ₁	1.65	2.13	.065	.084
b ₂	2.87	3.12	.113	.123
C	.4	.8	.016	.031
D	20.80	21.46	.819	.845
E	15.75	16.26	.610	.640
e	5.20	5.72	0.205	0.225
L	19.81	20.32	.780	.800
L ₁		4.50		.177
ØP	3.55	3.65	.140	.144
Q	5.89	6.40	0.232	0.252
R	4.32	5.49	.170	.216
S	6.15	BSC	242	BSC

Source-Drain Diode

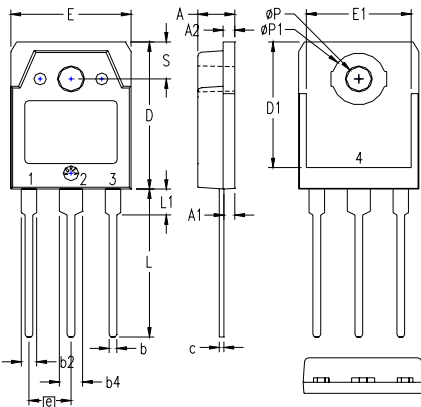
Symbol	Test Conditions	Characteristic Values		
		$(T_J = 25^\circ\text{C}$, unless otherwise specified)		
		Min.	Typ.	Max.
I_S	$V_{GS} = 0\text{ V}$			12 A
I_{SM}	Repetitive			36 A
V_{SD}	$I_F = I_S, V_{GS} = 0\text{ V}$, Note 1			1.5 V
t_{rr}	$I_S = 12\text{ A}, V_{GS} = 0\text{ V}$ $-di/dt = 100\text{ A}/\mu\text{s}, V_R = 100\text{ V}$		200	250 ns
Q_{rm}			0.8	μC
I_{rm}			4	A

 Note 1: Pulse test, $t \leq 300\ \mu\text{s}$, duty cycle $d \leq 2\%$
TO-3P (IXFQ) Outline

SYM	INCHES		MILLIMETERS	
	MIN	MAX	MIN	MAX
A	.185	.193	4.70	4.90
A ₁	.051	.059	1.30	1.50
A ₂	.057	.065	1.45	1.65
b	.035	.045	0.90	1.15
b ₂	.075	.087	1.90	2.20
b ₄	.114	.126	2.90	3.20
c	.022	.031	0.55	0.80
D	.780	.799	19.80	20.30
D ₁	.665	.677	16.90	17.20
E	.610	.622	15.50	15.80
E ₁	.531	.539	13.50	13.70
e	.215 BSC		5.45 BSC	
L	.779	.795	19.80	20.20
L ₁	.134	.142	3.40	3.60
ØP	.126	.134	3.20	3.40
ØP ₁	.272	.280	6.90	7.10
S	.193	.201	4.90	5.10

- 1 - GATE
- 2 - DRAIN (COLLECTOR)
- 3 - SOURCE (EMITTER)
- 4 - DRAIN (COLLECTOR)

IXYS reserves the right to change limits, test conditions, and dimensions.

IXYS MOSFETs and IGBTs are covered by one or more of the following U.S. patents:	4,835,592	4,931,844	5,049,961	5,237,481	6,162,665	6,404,065 B1	6,683,344	6,727,585	7,005,734 B2
	4,850,072	5,017,508	5,063,307	5,381,025	6,259,123 B1	6,534,343	6,710,405 B2	6,759,692	7,063,975 B2
	4,881,106	5,034,796	5,187,117	5,486,715	6,306,728 B1	6,583,505	6,710,463	6,771,478 B2	7,071,537

Fig. 1. Output Characteristics @ 25°C

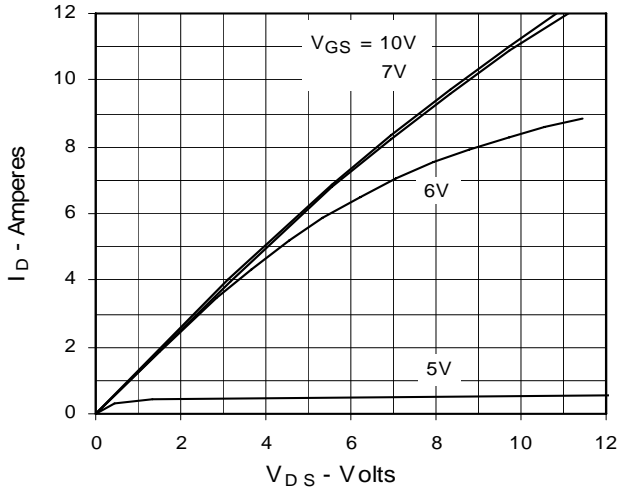

Fig. 2. Extended Output Characteristics @ 25°C

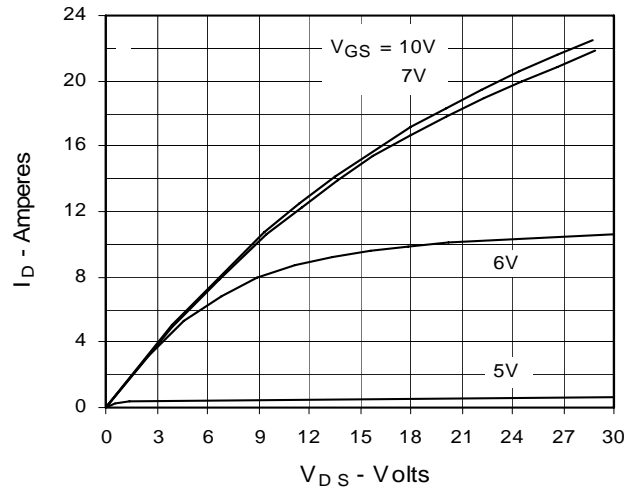

Fig. 3. Output Characteristics @ 125°C

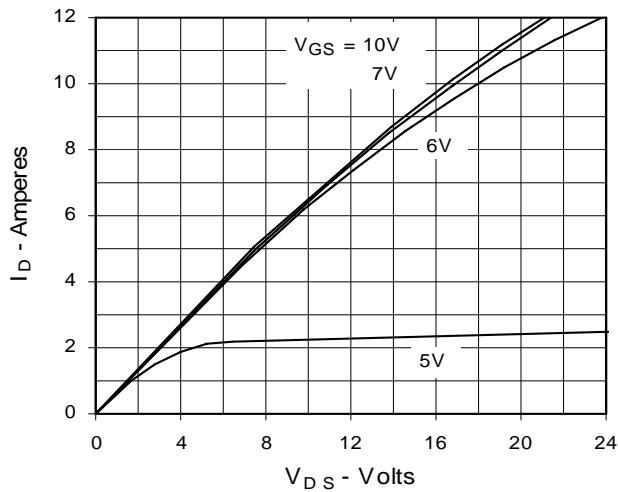

Fig. 4. $R_{DS(on)}$ Normalized to 0.5 I_{D25} Value vs. Junction Temperature

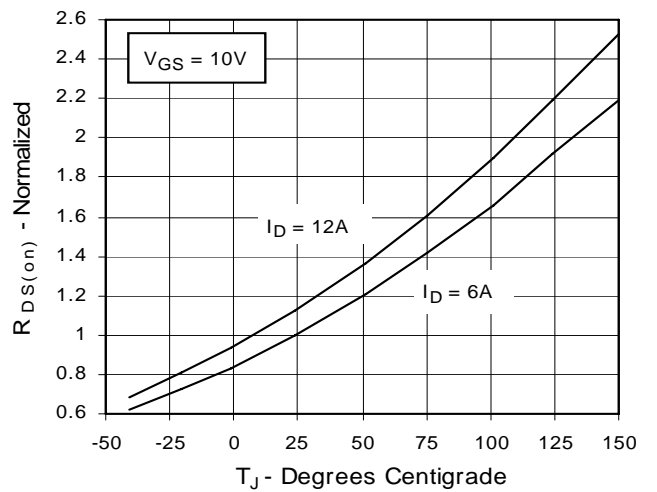

Fig. 5. $R_{DS(on)}$ Normalized to 0.5 I_{D25} Value vs. I_D

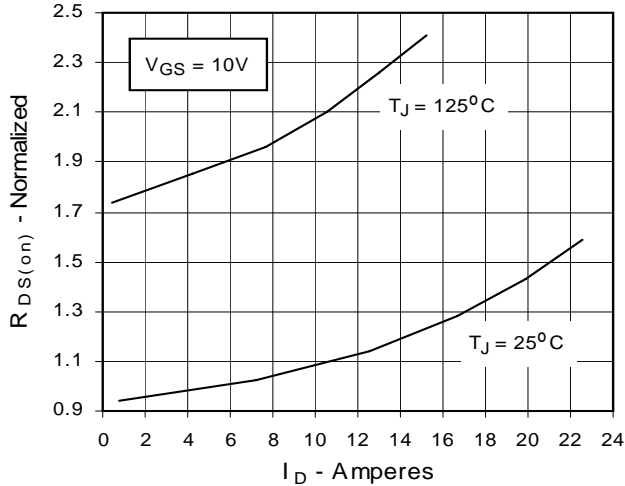

Fig. 6. Drain Current vs. Case Temperature

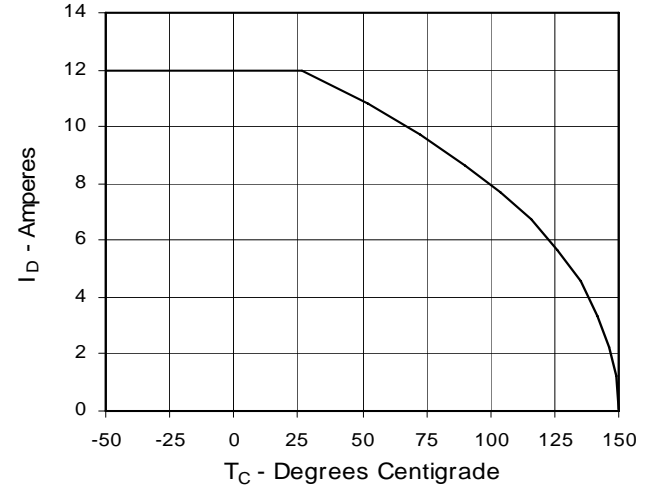

Fig. 7. Input Admittance

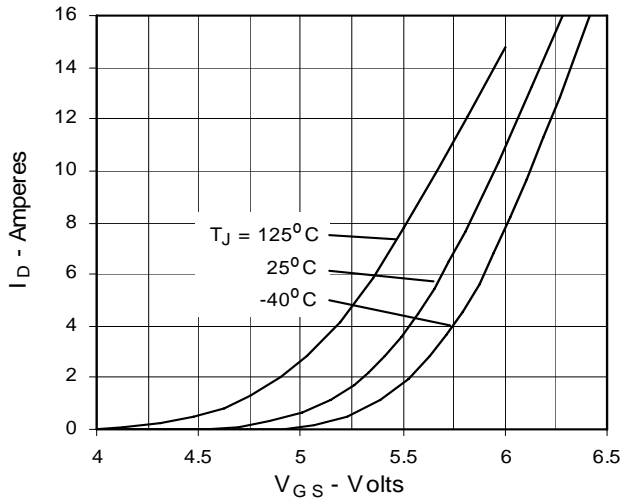

Fig. 8. Transconductance

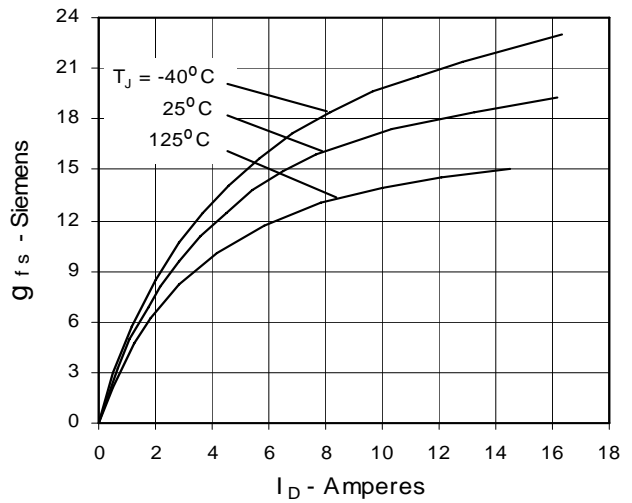

Fig. 9. Source Current vs. Source-To-Drain Voltage

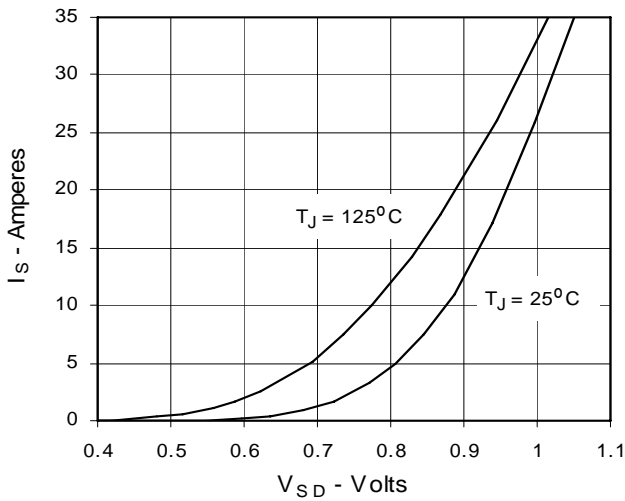

Fig. 10. Gate Charge

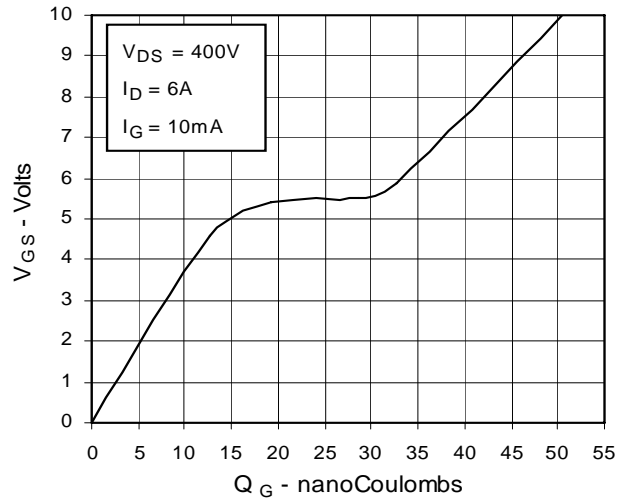
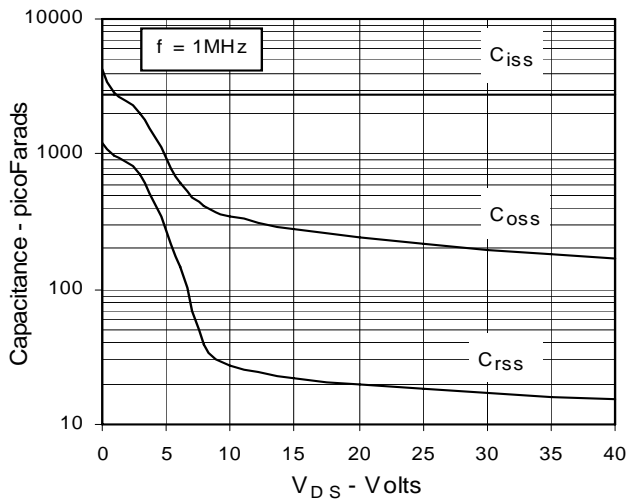

Fig. 11. Capacitance



Mouser Electronics

Authorized Distributor

Click to View Pricing, Inventory, Delivery & Lifecycle Information:

[IXYS:](#)

[IXFH12N80P](#) [IXFV12N80PS](#)