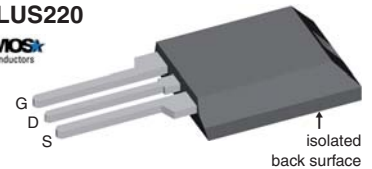

CoolMOS™ 1) Power MOSFET ISOPLUS™ Package

N-Channel Enhancement Mode
Low $R_{DS(on)}$, high V_{DSS} MOSFET
Electrically Isolated Back Surface

$I_{D25} = 25 \text{ A}$
 $V_{DSS} = 800 \text{ V}$
 $R_{DS(on) \text{ max}} = 150 \text{ m}\Omega$

ISOPLUS220
COOLMOS™
Power Semiconductors

E72873

MOSFET			
Symbol	Conditions	Maximum Ratings	
V_{DSS}	$T_{VJ} = 25^\circ\text{C}$	800	V
V_{GS}		± 20	V
I_{D25}	$T_C = 25^\circ\text{C}$	25	A
I_{D90}	$T_C = 90^\circ\text{C}$	18	A
E_{AS}	$T_{J \text{ start}} = 25^\circ\text{C}$; single pulse; $I_D = 3.4 \text{ A}$	670	mJ
E_{AR}	$T_{J \text{ start}} = 25^\circ\text{C}$; repetitive; $I_D = 17 \text{ A}$	0.5	mJ
dV/dt	$V_{DS} < V_{DSS}$; $I_F = 35 \text{ A}$; $T_{VJ} = 150^\circ\text{C}$ $dI_R/dt = 100 \text{ A}/\mu\text{s}$	6	V/ns

Features

- Silicon chip on Direct-Copper-Bond substrate
 - high power dissipation
 - isolated mounting surface
 - 2500 V electrical isolation
- 3rd generation CoolMOS™ 1) power MOSFET
 - high blocking capability
 - lowest resistance
 - avalanche rated for unclamped inductive switching (UIS)
- Low thermal resistance due to reduced chip thickness
- Low drain to tab capacitance (<30 pF)

Applications

- Switched mode power supplies (SMPS)
- Uninterruptible power supplies (UPS)
- Power factor correction (PFC)
- Welding
- Inductive heating

Advantages

- Easy assembly: no screws or isolation foils required
- Space savings
- High power density

¹⁾ CoolMOS™ is a trademark of Infineon Technologies AG.

Symbol	Conditions	Characteristic Values			
		(T _{VJ} = 25°C, unless otherwise specified)			
		min.	typ.	max.	
$R_{DS(on)}$	$V_{GS} = 10 \text{ V}$; $I_D = I_{D90}$		135	150	mΩ
$V_{GS(th)}$	$V_{DS} = V_{GS}$; $I_D = 2 \text{ mA}$	2		4	V
I_{DSS}	$V_{DS} = V_{DSS}$; $V_{GS} = 0 \text{ V}$			50	μA
			250		μA
I_{GSS}	$V_{GS} = \pm 20 \text{ V}$; $V_{DS} = 0 \text{ V}$			± 200	nA
C_{iss}	$V_{GS} = 0 \text{ V}$; $V_{DS} = 25 \text{ V}$; $f = 1 \text{ MHz}$		4600		pF
C_{oss}			2500		pF
C_{rss}			120		pF
Q_g	$V_{GS} = 0 \text{ to } 10 \text{ V}$; $V_{DS} = 640 \text{ V}$; $I_D = I_{D90}$		180		nC
Q_{gs}			20		nC
Q_{gd}			80		nC
$t_{d(on)}$	$V_{GS} = 10 \text{ V}$; $V_{DS} = 640 \text{ V}$; $T_{VJ} = 125^\circ\text{C}$ $I_D = 35 \text{ A}$; $R_G = 2.2 \Omega$		25		ns
t_r			25		ns
$t_{d(off)}$			75		ns
t_f			10		ns
R_{thJC}			0.5		K/W

Source-Drain Diode

Symbol	Conditions	Characteristic Values			
		min.	typ.	max.	
($T_{VJ} = 25^{\circ}\text{C}$, unless otherwise specified)					
I_S	$V_{GS} = 0\text{ V}$			34	A
V_{SD}	$I_F = 35\text{ A}; V_{GS} = 0\text{ V}$		1.0	1.2	V
t_{rr}	} $I_F = 35\text{ A}; -di_F/dt = 200\text{ A}/\mu\text{s}; V_R = 400\text{ V}$		550		ns
Q_{RM}			30		μC
I_{RM}			100		A

Component

Symbol	Conditions	Maximum Ratings	
T_{VJ}	operating	-55...+150	$^{\circ}\text{C}$
T_{stg}		-55...+150	$^{\circ}\text{C}$
V_{ISOL}	RMS, lead-to-tab, 50/60 Hz, $f = 1$ minute	2500	V~
F_C	mounting force	11-65/2.4-11	N/lb.

Symbol	Conditions	Characteristic Values		
		min.	typ.	max.
R_{thCH}	with heatsink compound	0.15		K/W
Weight		2.7		g

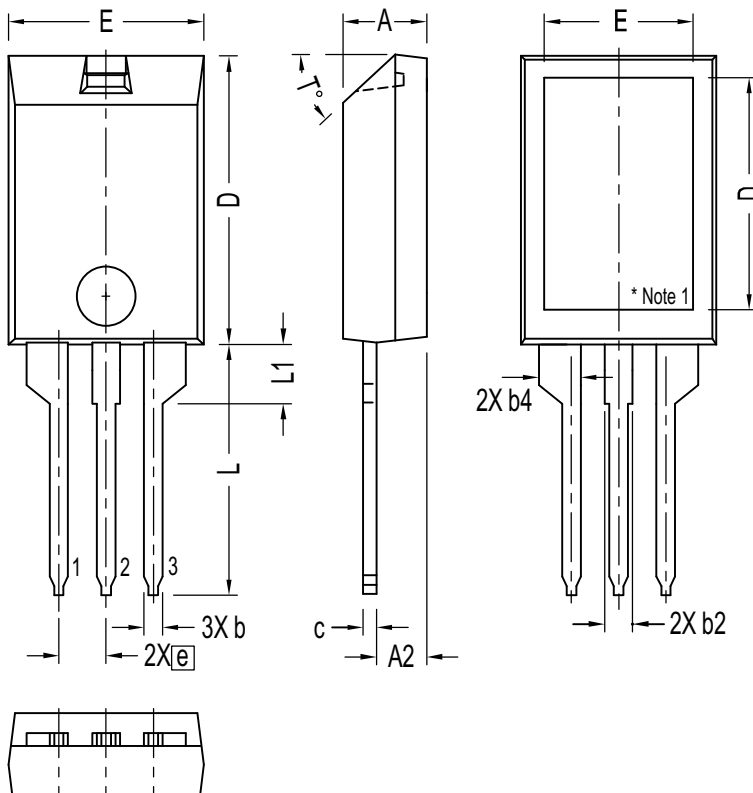
ISOPLUS220™ Outline

SYM	INCHES		MILLIMETERS	
	MIN	MAX	MIN	MAX
A	.157	.197	4.00	5.00
A2	.098	.118	2.50	3.00
b	.035	.051	0.90	1.30
b2	.049	.065	1.25	1.65
b4	.093	.100	2.35	2.55
c	.028	.039	0.70	1.00
D	.591	.630	15.00	16.00
D1	.472	.512	12.00	13.00
E	.394	.433	10.00	11.00
E1	.295	.335	7.50	8.50
e	.100 BASIC		2.55	BASIC
L	.512	.571	13.00	14.50
L1	.118	.138	3.00	3.50
T°			42.5°	47.5°

NOTE:

1. Bottom heatsink is electrically isolated from Pin 1, 2, or 3.
2. This drawing will meet dimensional requirement of JEDEC SS Product Outline TO-273 except D and D1 dimension.

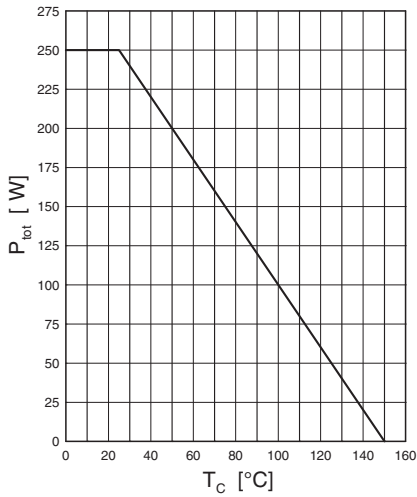

Fig. 1 Power Dissipation

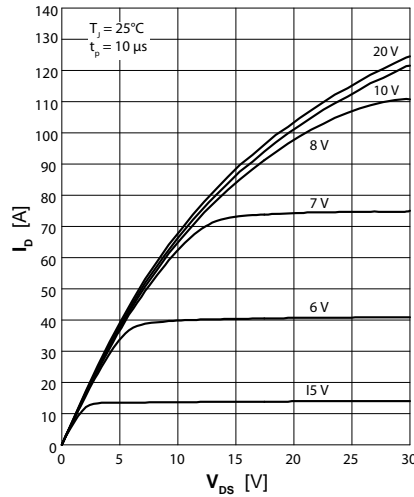

Fig. 2 Typ. Output Characteristics

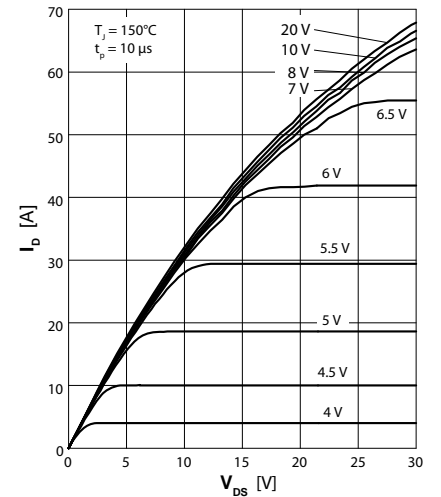

Fig. 3 Typ. Output Characteristics

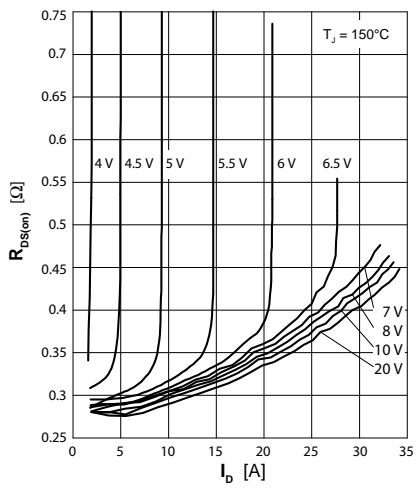

Fig. 4 Typ. Drain-Source on Resistance

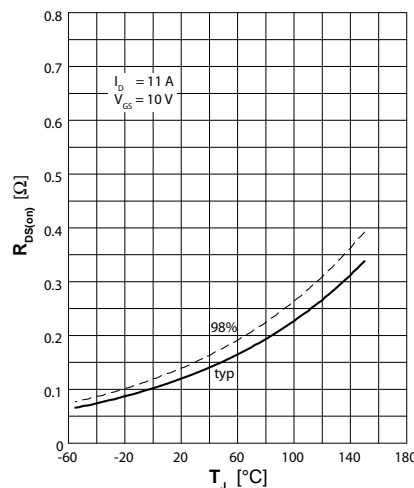

Fig. 5 Drain-Source On-State Resistance

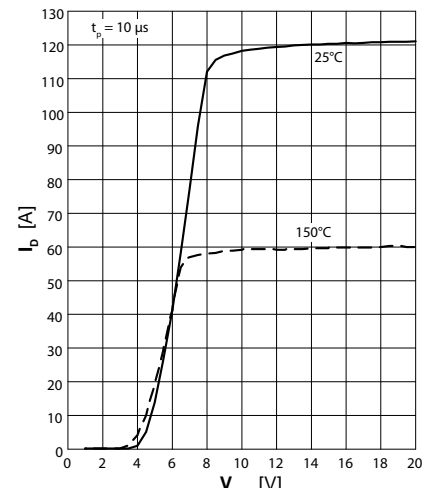

Fig. 6 Typ. Transfer Characteristics

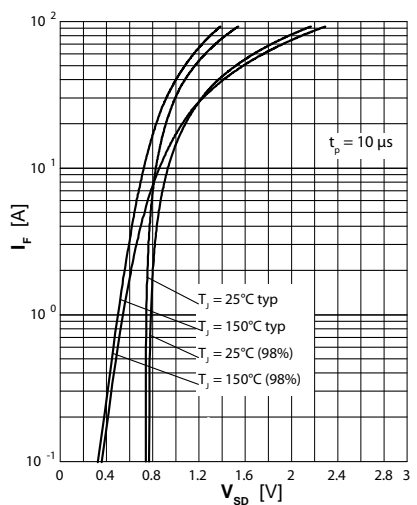

Fig. 7 Forward Characteristics of Body Diode

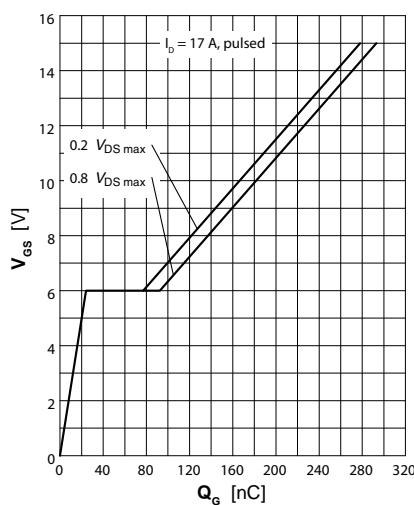

Fig. 8 Typ. Gate Charge

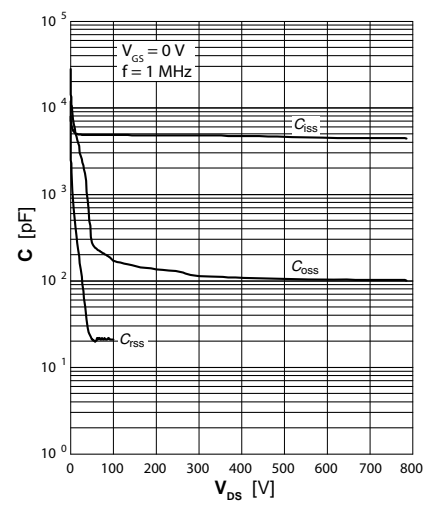

Fig. 9 Capacitance

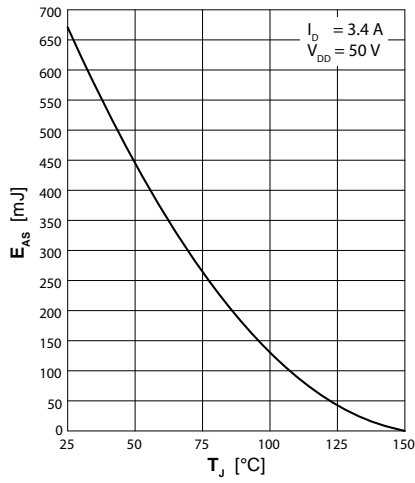

Fig. 10 Typ. Avalanche Energy

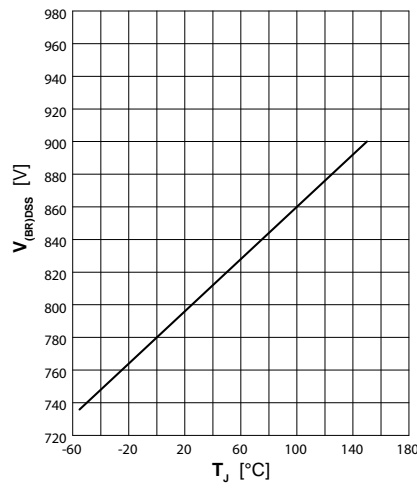

Fig. 11 Drain-Source Breakdown Voltage

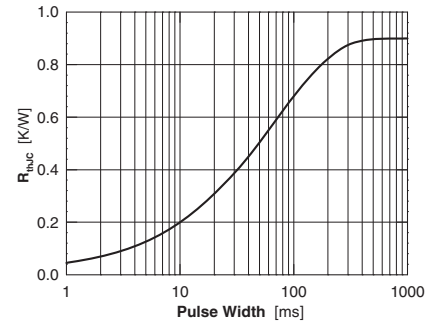

Fig. 12 Maximum Transient Thermal Resistance

Mouser Electronics

Authorized Distributor

Click to View Pricing, Inventory, Delivery & Lifecycle Information:

[IXYS:](#)

[IXKC25N80C](#)