

Standard Rectifier Module

3~ Rectifier
$V_{RRM} = 1200\text{ V}$
$I_{DAV} = 175\text{ A}$
$I_{FSM} = 1800\text{ A}$

3~ Rectifier Bridge

Part number

VUO160-12NO7

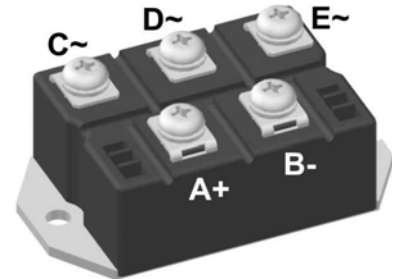

E72873

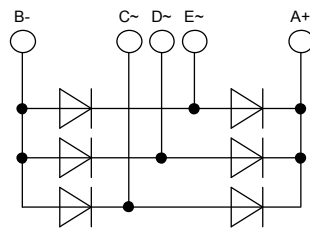

Features / Advantages:

- Package with DCB ceramic
- Improved temperature and power cycling
- Planar passivated chips
- Very low forward voltage drop
- Very low leakage current

Applications:

- Diode for main rectification
- For three phase bridge configurations
- Supplies for DC power equipment
- Input rectifiers for PWM inverter
- Battery DC power supplies
- Field supply for DC motors

Package: PWS-E

- Industry standard outline
- RoHS compliant
- Easy to mount with two screws
- Base plate: Copper internally DCB isolated
- Advanced power cycling

Rectifier				Ratings			
Symbol	Definition	Conditions		min.	typ.	max.	Unit
V_{RSM}	max. non-repetitive reverse blocking voltage					1300	V
V_{RRM}	max. repetitive reverse blocking voltage					1200	V
I_R	reverse current	$V_R = 1200$ V	$T_{VJ} = 25^\circ\text{C}$			200	μA
		$V_R = 1200$ V	$T_{VJ} = 150^\circ\text{C}$			2	mA
V_F	forward voltage drop	$I_F = 60$ A	$T_{VJ} = 25^\circ\text{C}$			1.10	V
						1.40	V
		$I_F = 180$ A	$T_{VJ} = 125^\circ\text{C}$			1.00	V
						1.39	V
I_{DAV}	bridge output current	$T_C = 110^\circ\text{C}$ rectangular	$T_{VJ} = 150^\circ\text{C}$			175	A
V_{FO}	threshold voltage					0.77	V
r_F	slope resistance					3.4	m Ω
R_{thJC}	thermal resistance junction to case					0.5	K/W
R_{thCH}	thermal resistance case to heatsink				0.2		K/W
P_{tot}	total power dissipation			$T_C = 25^\circ\text{C}$		250	W
I_{FSM}	max. forward surge current	$t = 10$ ms; (50 Hz), sine	$T_{VJ} = 45^\circ\text{C}$			1.80	kA
		$t = 8,3$ ms; (60 Hz), sine	$V_R = 0$ V			1.95	kA
		$t = 10$ ms; (50 Hz), sine	$T_{VJ} = 150^\circ\text{C}$			1.53	kA
		$t = 8,3$ ms; (60 Hz), sine	$V_R = 0$ V			1.65	kA
I^2t	value for fusing	$t = 10$ ms; (50 Hz), sine	$T_{VJ} = 45^\circ\text{C}$			16.2	kA ² s
		$t = 8,3$ ms; (60 Hz), sine	$V_R = 0$ V			15.7	kA ² s
		$t = 10$ ms; (50 Hz), sine	$T_{VJ} = 150^\circ\text{C}$			11.7	kA ² s
		$t = 8,3$ ms; (60 Hz), sine	$V_R = 0$ V			11.3	kA ² s
C_J	junction capacitance	$V_R = 400$ V; $f = 1$ MHz		$T_{VJ} = 25^\circ\text{C}$		35	pF

Package PWS-E			Ratings			
Symbol	Definition	Conditions	min.	typ.	max.	Unit
I_{RMS}	RMS current	per terminal			200	A
T_{stg}	storage temperature		-40		125	°C
T_{VJ}	virtual junction temperature		-40		150	°C
Weight				284		g
M_D	mounting torque		4.25		5.75	Nm
M_T	terminal torque		4.25		5.75	Nm
$d_{Spp/App}$	creepage distance on surface striking distance through air	terminal to terminal	12.0			mm
$d_{Spt/Abp}$		terminal to backside	26.0			mm
V_{ISOL}	isolation voltage	t = 1 second	3000			V
		t = 1 minute	2500			V

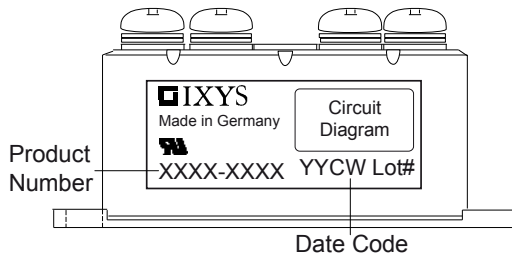

Ordering	Part Number	Marking on Product	Delivery Mode	Quantity	Code No.
Standard	VUO160-12NO7	VUO160-12NO7	Box	5	462446

Equivalent Circuits for Simulation

* on die level

$T_{VJ} = 150\text{ °C}$



Rectifier

$V_{0\ max}$	threshold voltage	0.77	V
$R_{0\ max}$	slope resistance *	2.2	mΩ

Outlines PWS-E

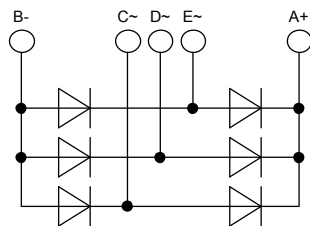
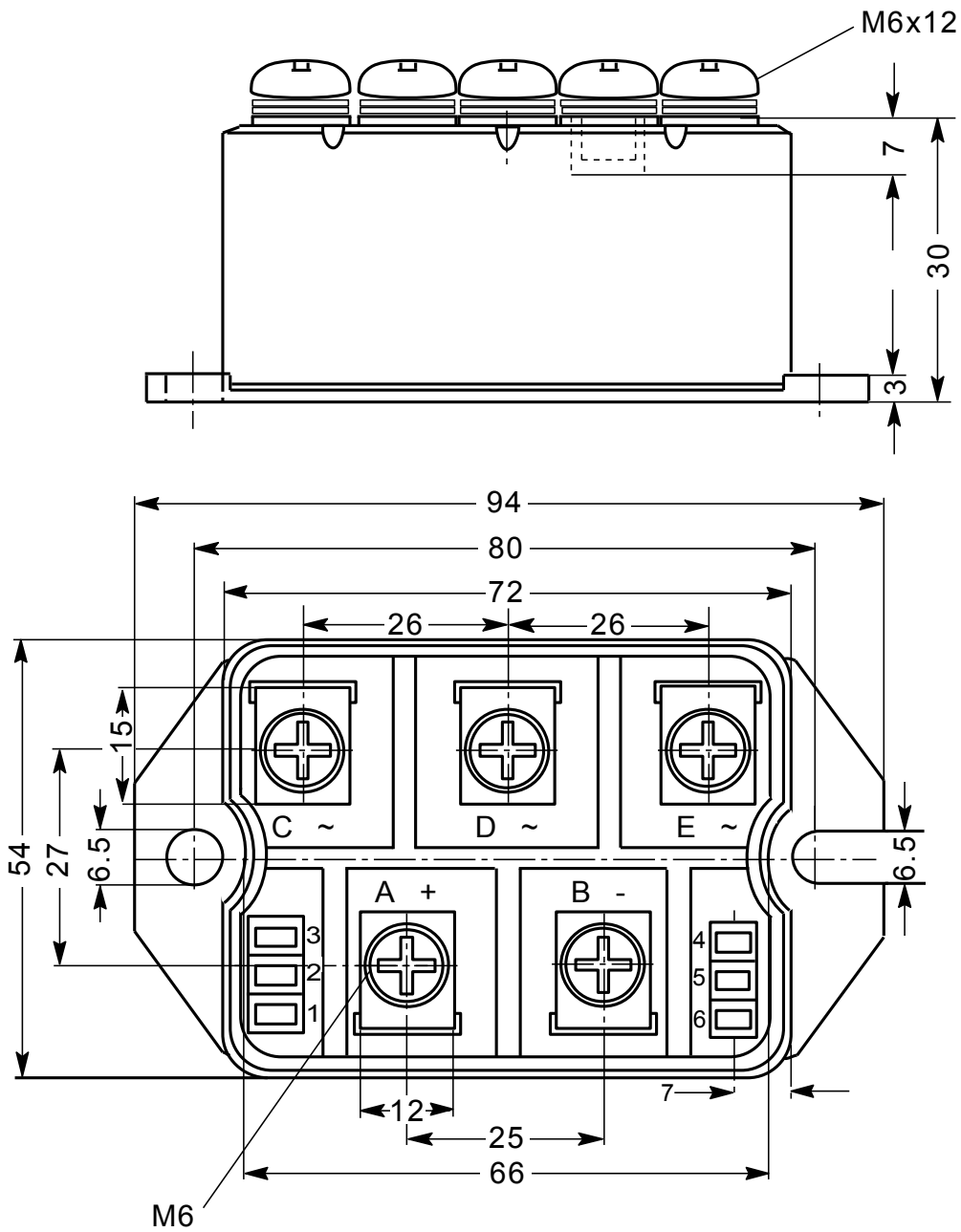

Rectifier

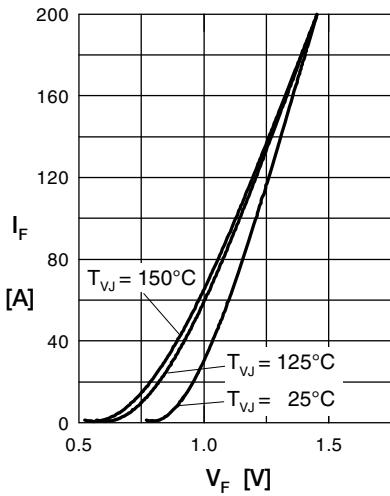

Fig. 1 Forward current vs. voltage drop per diode

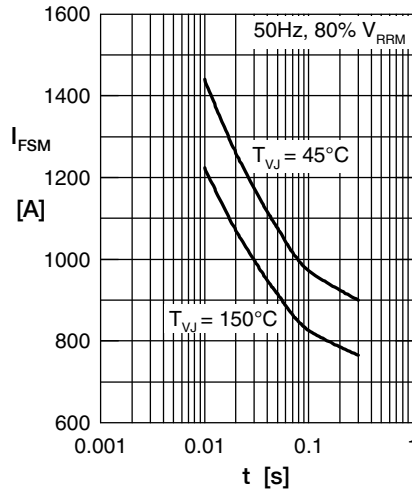

Fig. 2 Surge overload current vs. time per diode

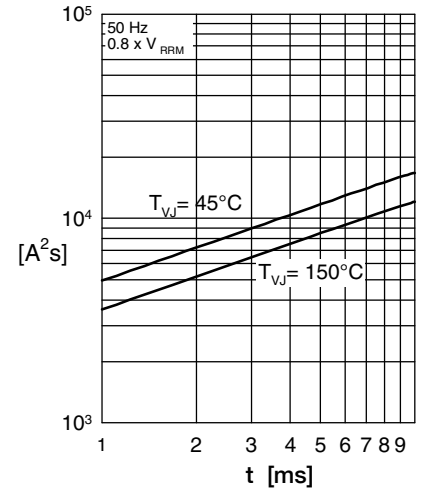

Fig. 3 I^2t vs. time per diode

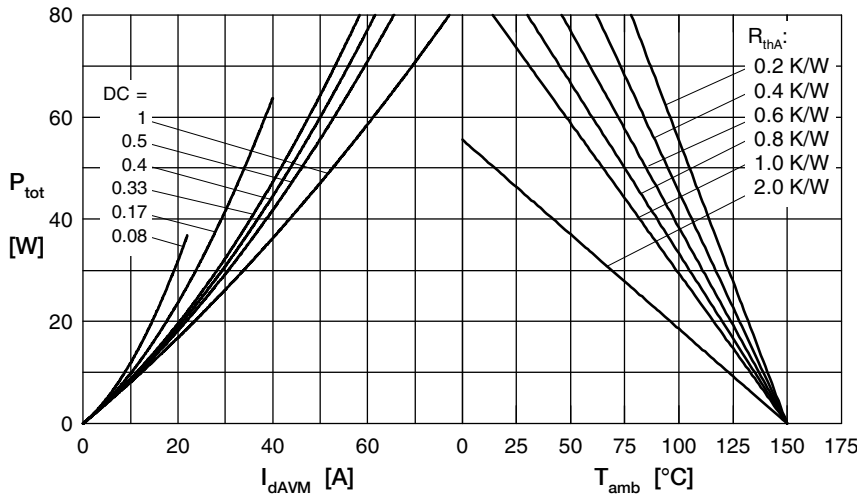

Fig. 4 Power dissipation vs. forward current and ambient temperature per diode

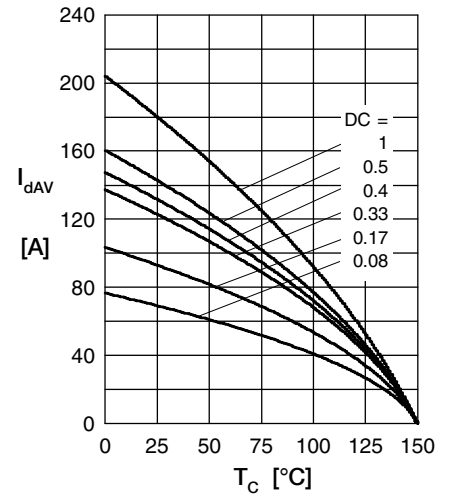

Fig. 5 Max. forward current vs. case temperature per diode

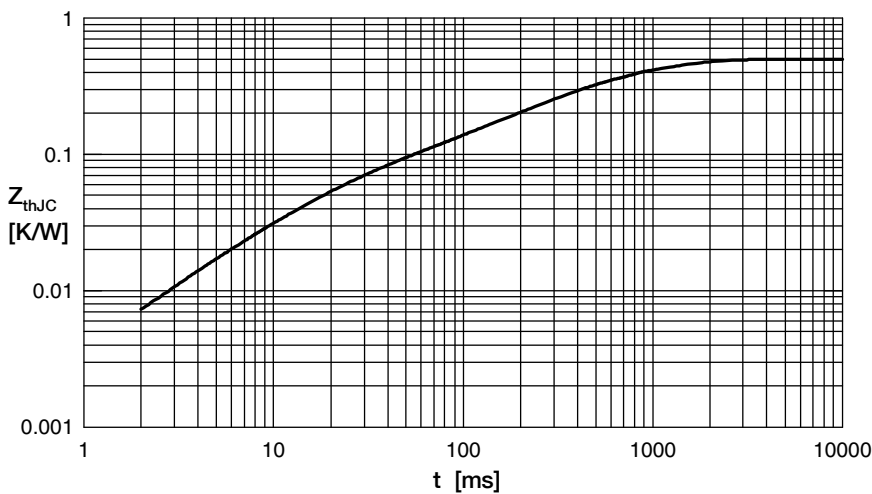

Fig. 6 Transient thermal impedance junction to case vs. time per diode

R_i	t_i
0.050	0.02
0.003	0.01
0.120	0.225
0.217	0.8
0.110	0.58

Mouser Electronics

Authorized Distributor

Click to View Pricing, Inventory, Delivery & Lifecycle Information:

[IXYS:](#)

[VUO160-12NO7](#)