

Thyristor Module

3~ Rectifier	Brake Chopper
$V_{RRM} = 1600$	$V_{CES} = 1200$
$I_{DAV} = 150$	$I_{C25} = 120$
$I_{FSM} = 700$	$V_{CE(sat)} = 1,8$

3~ Rectifier Bridge, half-controlled (high-side) + Brake Unit + NTC

Part number

VVZB135-16ioXT

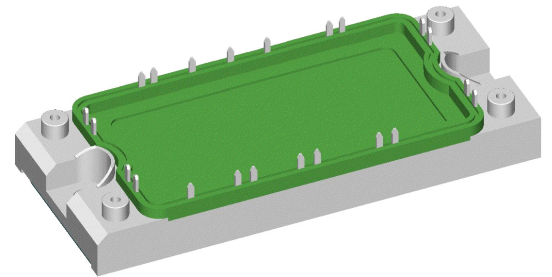

Backside: isolated

E72873

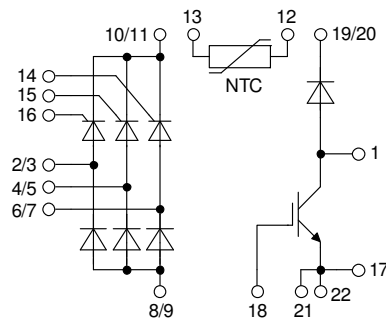

Features / Advantages:

- Package with DCB ceramic
- Improved temperature and power cycling
- Planar passivated chips
- Very low forward voltage drop
- Very low leakage current
- NTC

Applications:

- 3~ Rectifier with brake unit for drive inverters

Package: E2-Pack

- Isolation Voltage: 3600 V~
- Industry standard outline
- RoHS compliant
- Soldering pins for PCB mounting
- Height: 17 mm
- Base plate: DCB ceramic
- Reduced weight
- Advanced power cycling

Terms Conditions of usage:

The data contained in this product data sheet is exclusively intended for technically trained staff. The user will have to evaluate the suitability of the product for the intended application and the completeness of the product data with respect to his application. The specifications of our components may not be considered as an assurance of component characteristics. The information in the valid application- and assembly notes must be considered. Should you require product information in excess of the data given in this product data sheet or which concerns the specific application of your product, please contact the sales office, which is responsible for you.

Due to technical requirements our product may contain dangerous substances. For information on the types in question please contact the sales office, which is responsible for you.

Should you intend to use the product in aviation, in health or live endangering or life support applications, please notify. For any such application we urgently recommend

- to perform joint risk and quality assessments;

- the conclusion of quality agreements;

- to establish joint measures of an ongoing product survey, and that we may make delivery dependent on the realization of any such measures.

Rectifier				Ratings			
Symbol	Definition	Conditions	min.	typ.	max.	Unit	
$V_{RSM/DSM}$	max. non-repetitive reverse/forward blocking voltage	$T_{VJ} = 25^{\circ}C$			1700	V	
$V_{RRM/DRM}$	max. repetitive reverse/forward blocking voltage	$T_{VJ} = 25^{\circ}C$			1600	V	
I_{RD}	reverse current, drain current	$V_{R/D} = 1600 V$	$T_{VJ} = 25^{\circ}C$		100	μA	
		$V_{R/D} = 1600 V$	$T_{VJ} = 150^{\circ}C$		20	mA	
V_T	forward voltage drop	$I_T = 50 A$	$T_{VJ} = 25^{\circ}C$		1,32	V	
		$I_T = 150 A$			1,92	V	
		$I_T = 50 A$	$T_{VJ} = 125^{\circ}C$		1,26	V	
		$I_T = 150 A$			1,96	V	
I_{DAV}	bridge output current	$T_C = 85^{\circ}C$ rectangular $d = 1/3$	$T_{VJ} = 150^{\circ}C$		150	A	
V_{T0}	threshold voltage	} for power loss calculation only	$T_{VJ} = 150^{\circ}C$		0,88	V	
r_T	slope resistance				7,3	m Ω	
R_{thJC}	thermal resistance junction to case				0,65	K/W	
R_{thCH}	thermal resistance case to heatsink			0,10		K/W	
P_{tot}	total power dissipation		$T_C = 25^{\circ}C$		190	W	
I_{TSM}	max. forward surge current	$t = 10 ms; (50 Hz), sine$	$T_{VJ} = 45^{\circ}C$		700	A	
		$t = 8,3 ms; (60 Hz), sine$	$V_R = 0 V$		755	A	
		$t = 10 ms; (50 Hz), sine$	$T_{VJ} = 150^{\circ}C$		595	A	
		$t = 8,3 ms; (60 Hz), sine$	$V_R = 0 V$		645	A	
I^2t	value for fusing	$t = 10 ms; (50 Hz), sine$	$T_{VJ} = 45^{\circ}C$		2,45	kA ² s	
		$t = 8,3 ms; (60 Hz), sine$	$V_R = 0 V$		2,37	kA ² s	
		$t = 10 ms; (50 Hz), sine$	$T_{VJ} = 150^{\circ}C$		1,77	kA ² s	
		$t = 8,3 ms; (60 Hz), sine$	$V_R = 0 V$		1,73	kA ² s	
C_J	junction capacitance	$V_R = 400 V f = 1 MHz$	$T_{VJ} = 25^{\circ}C$		32	pF	
P_{GM}	max. gate power dissipation	$t_p = 30 \mu s$	$T_C = 150^{\circ}C$		10	W	
		$t_p = 300 \mu s$			5	W	
P_{GAV}	average gate power dissipation				0,5	W	
$(di/dt)_{cr}$	critical rate of rise of current	$T_{VJ} = 150^{\circ}C; f = 50 Hz$ repetitive, $I_T = 150 A$			150	A/ μs	
		$t_p = 200 \mu s; di_G/dt = 0,45 A/\mu s;$ $I_G = 0,45 A; V = 2/3 V_{DRM}$ non-repet., $I_T = 50 A$			500	A/ μs	
$(dv/dt)_{cr}$	critical rate of rise of voltage	$V = 2/3 V_{DRM}$ $R_{GK} = \infty; method 1 (linear voltage rise)$	$T_{VJ} = 150^{\circ}C$		1000	V/ μs	
V_{GT}	gate trigger voltage	$V_D = 6 V$	$T_{VJ} = 25^{\circ}C$		1,4	V	
			$T_{VJ} = -40^{\circ}C$		1,6	V	
I_{GT}	gate trigger current	$V_D = 6 V$	$T_{VJ} = 25^{\circ}C$		80	mA	
			$T_{VJ} = -40^{\circ}C$		200	mA	
V_{GD}	gate non-trigger voltage	$V_D = 2/3 V_{DRM}$	$T_{VJ} = 150^{\circ}C$		0,2	V	
I_{GD}	gate non-trigger current				5	mA	
I_L	latching current	$t_p = 10 \mu s$	$T_{VJ} = 25^{\circ}C$		450	mA	
		$I_G = 0,45 A; di_G/dt = 0,45 A/\mu s$					
I_H	holding current	$V_D = 6 V R_{GK} = \infty$	$T_{VJ} = 25^{\circ}C$		100	mA	
t_{gd}	gate controlled delay time	$V_D = 1/2 V_{DRM}$	$T_{VJ} = 25^{\circ}C$		2	μs	
		$I_G = 0,45 A; di_G/dt = 0,45 A/\mu s$					
t_q	turn-off time	$V_R = 100 V; I_T = 50 A; V = 2/3 V_{DRM}$ $di/dt = 10 A/\mu s dv/dt = 20 V/\mu s t_p = 200 \mu s$	$T_{VJ} = 125^{\circ}C$		150	μs	

Brake IGBT				Ratings			
Symbol	Definition	Conditions	min.	typ.	max.	Unit	
V_{CES}	collector emitter voltage	$T_{VJ} = 25^{\circ}\text{C}$			1200	V	
V_{GES}	max. DC gate voltage				± 20	V	
V_{GEM}	max. transient gate emitter voltage				± 30	V	
I_{C25}	collector current	$T_C = 25^{\circ}\text{C}$			120	A	
I_{C80}		$T_C = 80^{\circ}\text{C}$			84	A	
P_{tot}	total power dissipation	$T_C = 25^{\circ}\text{C}$			390	W	
$V_{CE(sat)}$	collector emitter saturation voltage	$I_C = 75\text{ A}; V_{GE} = 15\text{ V}$			1,8	V	
					2,1	V	
$V_{GE(th)}$	gate emitter threshold voltage	$I_C = 3\text{ mA}; V_{GE} = V_{CE}$	5,5	6,0	6,5	V	
I_{CES}	collector emitter leakage current	$V_{CE} = V_{CES}; V_{GE} = 0\text{ V}$			0,2	mA	
					0,6	mA	
I_{GES}	gate emitter leakage current	$V_{GE} = \pm 20\text{ V}$			500	nA	
$Q_{G(on)}$	total gate charge	$V_{CE} = 600\text{ V}; V_{GE} = 15\text{ V}; I_C = 75\text{ A}$		230		nC	
$t_{d(on)}$	turn-on delay time	inductive load $V_{CE} = 600\text{ V}; I_C = 75\text{ A}$ $V_{GE} = \pm 15\text{ V}; R_G = 10\ \Omega$	$T_{VJ} = 125^{\circ}\text{C}$		70	ns	
t_r	current rise time				40	ns	
$t_{d(off)}$	turn-off delay time				250	ns	
t_f	current fall time				100	ns	
E_{on}	turn-on energy per pulse				6,8	mJ	
E_{off}	turn-off energy per pulse				8,3	mJ	
RBSOA	reverse bias safe operating area	$V_{GE} = \pm 15\text{ V}; R_G = 10\ \Omega$	$T_{VJ} = 125^{\circ}\text{C}$				
I_{CM}		$V_{CEK} = 1200\text{ V}$			225	A	
SCSOA	short circuit safe operating area	$V_{CEK} = 1200\text{ V}$					
t_{SC}	short circuit duration	$V_{CE} = 900\text{ V}; V_{GE} = \pm 15\text{ V}$	$T_{VJ} = 125^{\circ}\text{C}$		10	μs	
I_{SC}	short circuit current	$R_G = 10\ \Omega$; non-repetitive		300		A	
R_{thJC}	thermal resistance junction to case				0,32	K/W	
R_{thCH}	thermal resistance case to heatsink				0,15	K/W	
Brake Diode							
V_{RRM}	max. repetitive reverse voltage		$T_{VJ} = 25^{\circ}\text{C}$		1200	V	
I_{F25}	forward current		$T_C = 25^{\circ}\text{C}$		48	A	
I_{F80}			$T_C = 80^{\circ}\text{C}$		32	A	
V_F	forward voltage	$I_F = 30\text{ A}$	$T_{VJ} = 25^{\circ}\text{C}$		2,75	V	
			$T_{VJ} = 125^{\circ}\text{C}$	1,99		V	
I_R	reverse current	$V_R = V_{RRM}$	$T_{VJ} = 25^{\circ}\text{C}$		0,25	mA	
			$T_{VJ} = 125^{\circ}\text{C}$		1	mA	
Q_{rr}	reverse recovery charge	$V_R = 600\text{ V}$ $-di_f/dt = 400\text{ A}/\mu\text{s}$ $I_F = 30\text{ A}$	$T_{VJ} = 125^{\circ}\text{C}$		1,8	μC	
I_{RM}	max. reverse recovery current				23	A	
t_{rr}	reverse recovery time				150	ns	
R_{thJC}	thermal resistance junction to case				0,9	K/W	
R_{thCH}	thermal resistance case to heatsink				0,3	K/W	

Package E2-Pack		Ratings				
Symbol	Definition	Conditions	min.	typ.	max.	Unit
I_{RMS}	RMS current	per terminal			200	A
T_{VJ}	virtual junction temperature		-40		150	°C
T_{op}	operation temperature		-40		125	°C
T_{stg}	storage temperature		-40		125	°C
Weight				176		g
M_D	mounting torque		3		6	Nm
$d_{Spp/App}$	creepage distance on surface / striking distance through air	terminal to terminal	6,0			mm
$d_{Spb/Apb}$		terminal to backside	12,0			mm
V_{ISOL}	isolation voltage	t = 1 second	3600			V
		t = 1 minute	3000			V

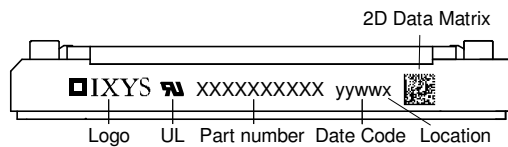

Ordering	Ordering Number	Marking on Product	Delivery Mode	Quantity	Code No.
Standard	VVZB135-16ioXT	VVZB135-16ioXT	Box	6	510134

Temperature Sensor NTC

Symbol	Definition	Conditions	min.	typ.	max.	Unit
R_{25}	resistance	$T_{VJ} = 25^\circ$	4,75	5	5,25	kΩ
$B_{25/50}$	temperature coefficient			3375		K

Equivalent Circuits for Simulation

* on die level

$T_{VJ} = 150^\circ\text{C}$

		Thyristor	Brake IGBT	Brake Diode	
V_0	threshold voltage	0,88	1,1	1,31	V
R_0	slope resistance *	4,1	17,9	8	mΩ

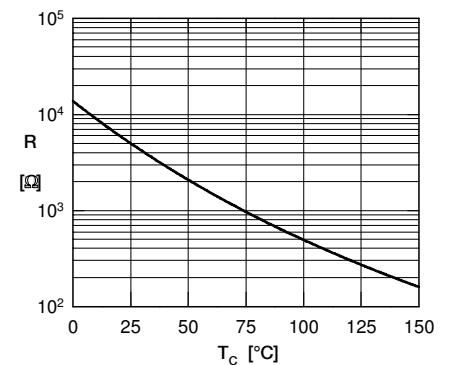

Typ. NTC resistance vs. temperature

Outlines E2-Pack

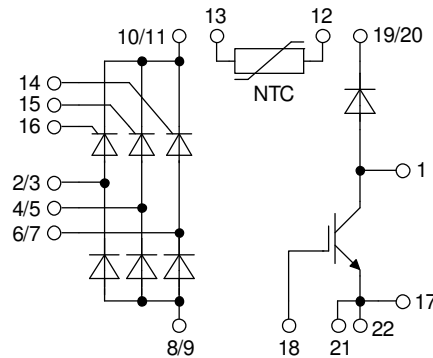
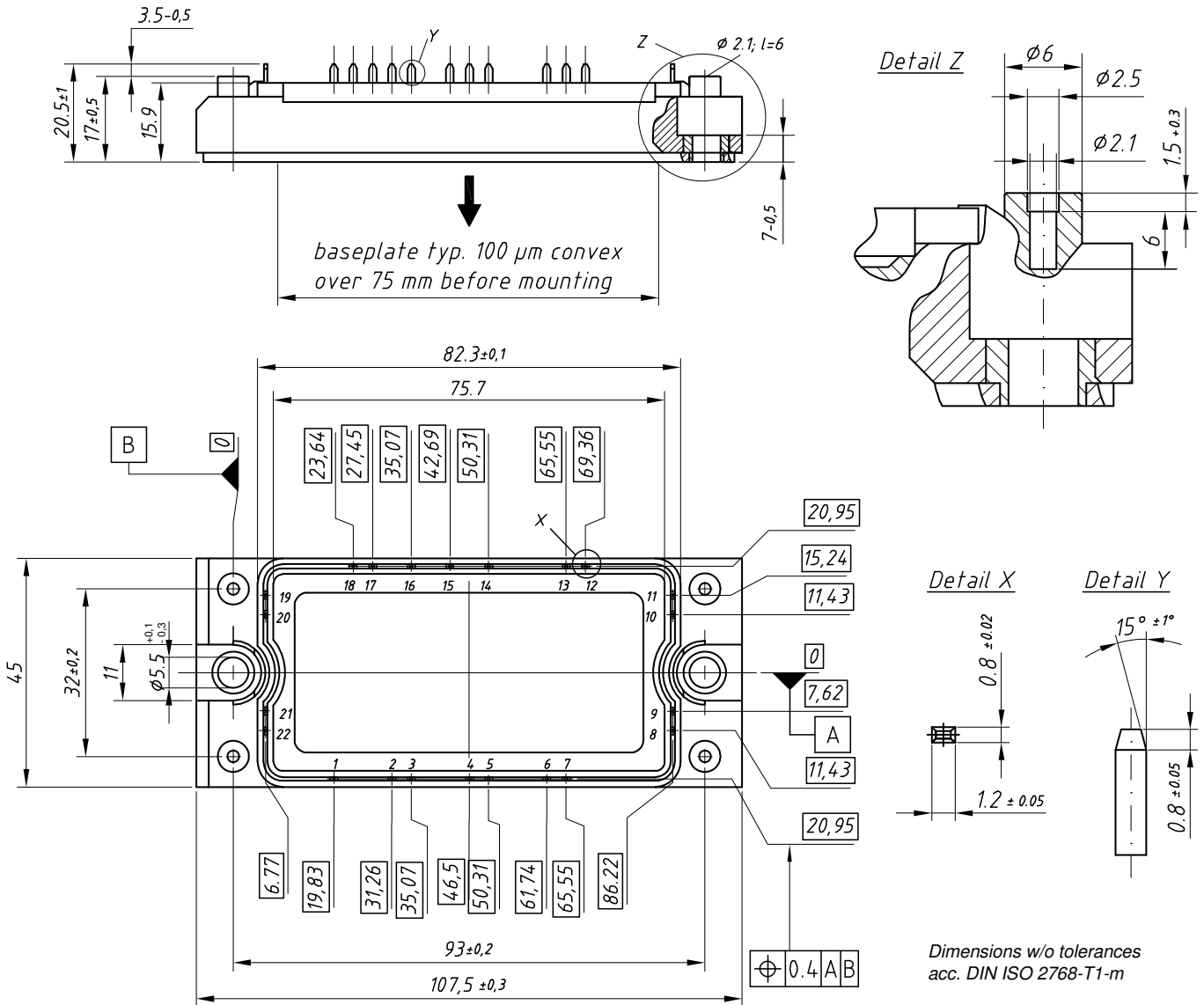

Thyristor

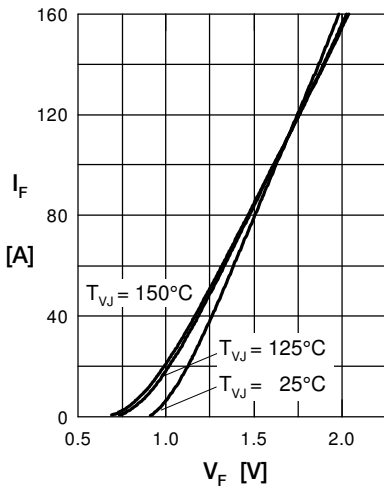

Fig. 1 Forward current vs. voltage drop per thyristor

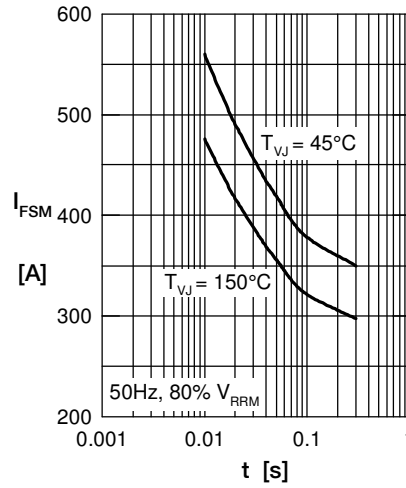

Fig. 2 Surge overload current vs. time per thyristor

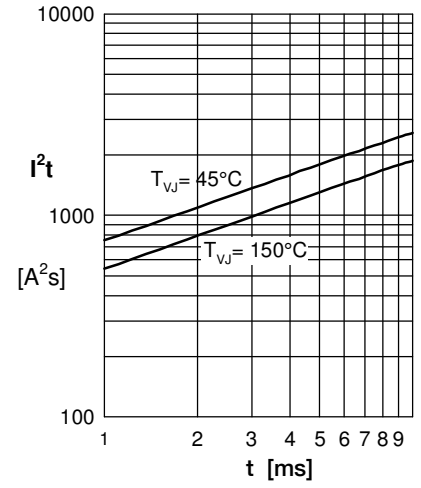

Fig. 3 I^2t vs. time per thyristor

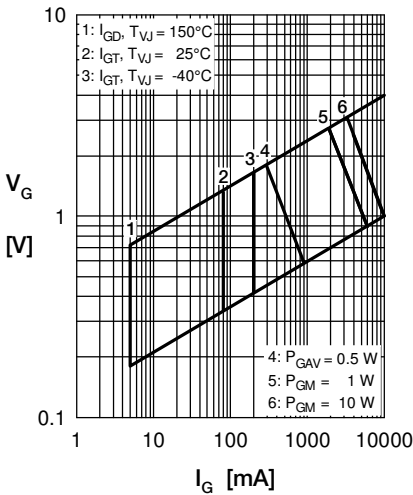

Fig. 4 Gate trigger characteristics

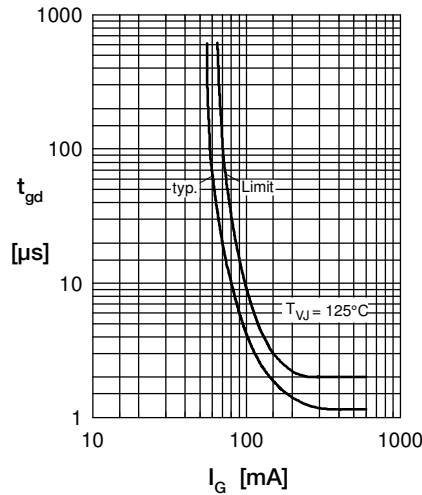

Fig. 5 Gate controlled delay time

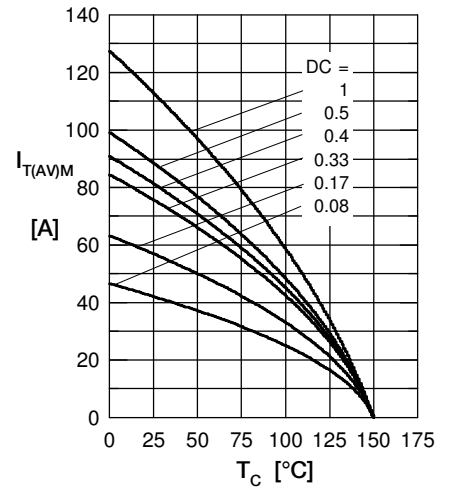

Fig. 5 Max. forward current vs. case temperature per thyristor

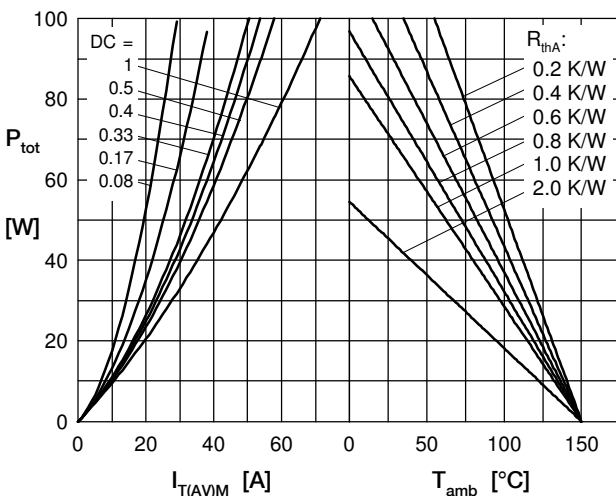

Fig. 4 Power dissipation vs. forward current and ambient temperature per thyristor

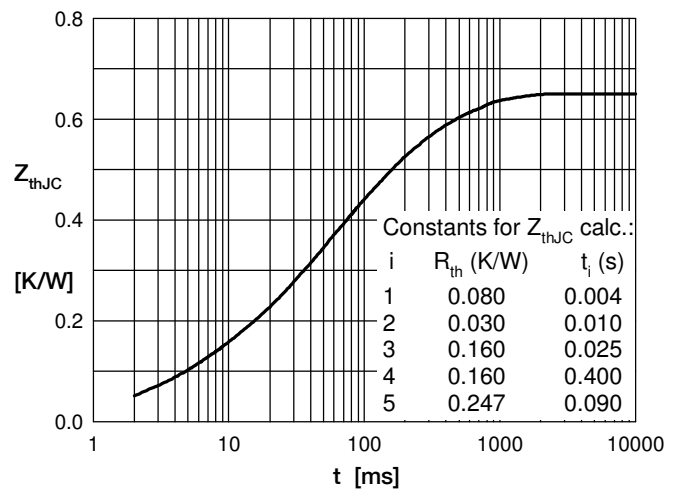

Fig. 6 Transient thermal impedance junction to case vs. time per thyristor

Brake IGBT

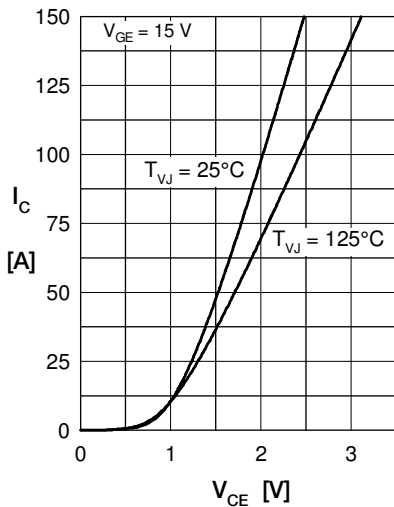

Fig. 1 Typ. output characteristics

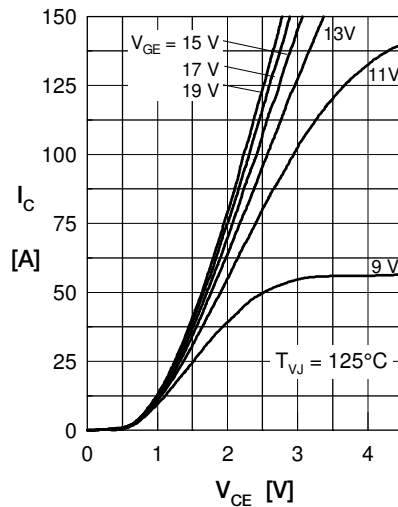

Fig. 2 Typ. output characteristics

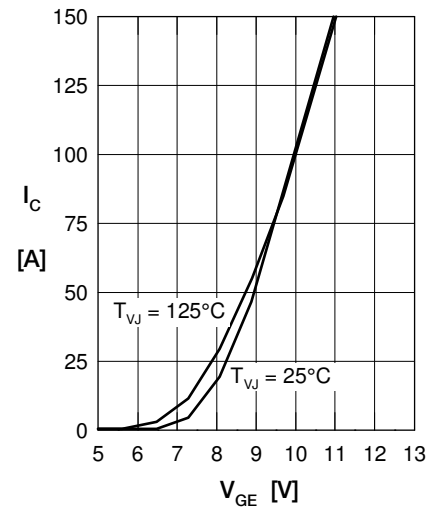

Fig. 3 Typ. transfer characteristics

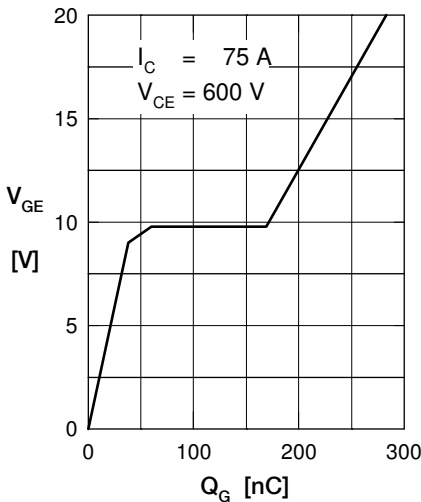

Fig. 4 Typ. turn-on gate charge

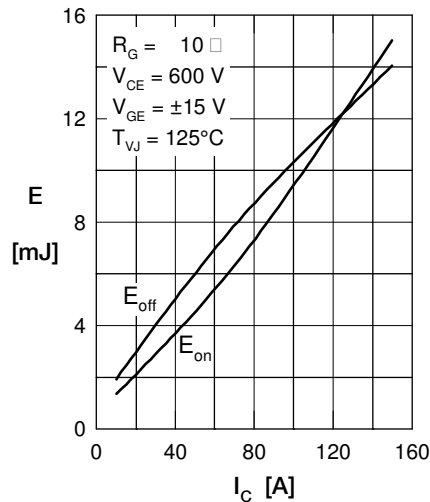

Fig. 5 Typ. switching energy versus collector current

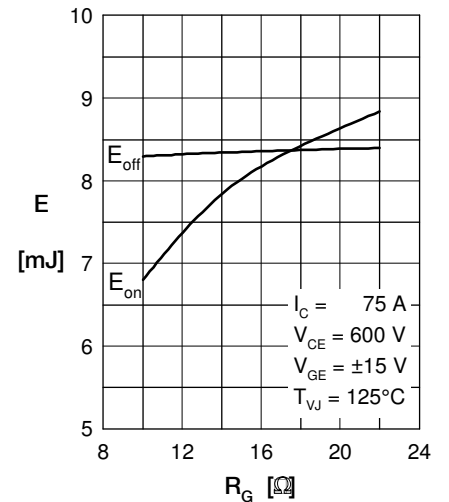

Fig. 6 Typ. switching energy versus gate resistance

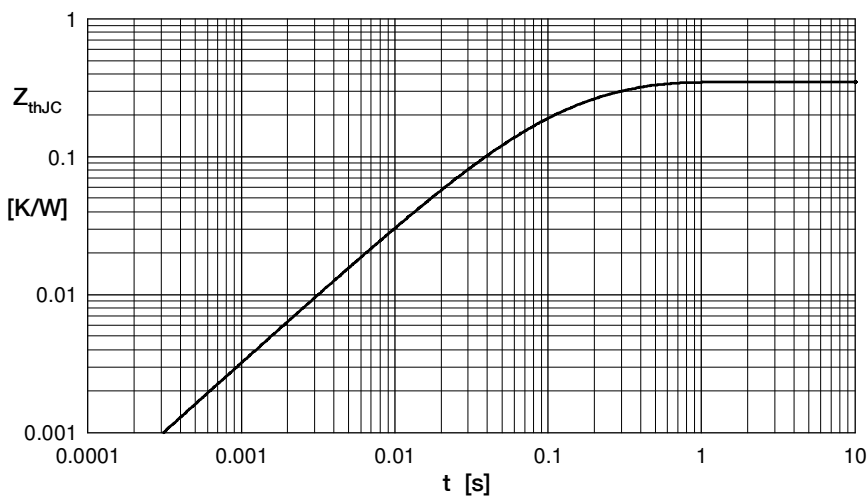

Fig. 7 Typ. transient thermal impedance junction to case

Brake Diode

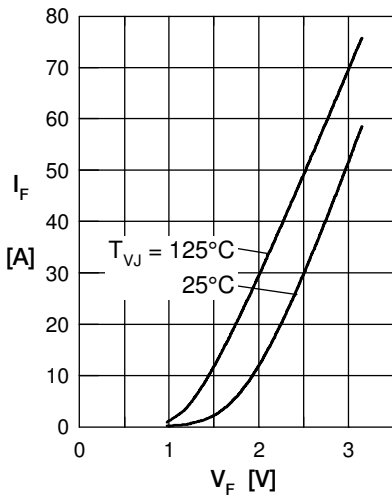

Fig. 1 Forward current I_F vs. V_F

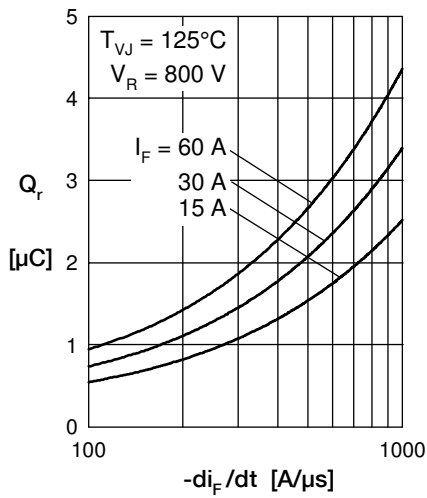

Fig. 2 Typ. reverse recovery charge Q_r versus $-di_F/dt$

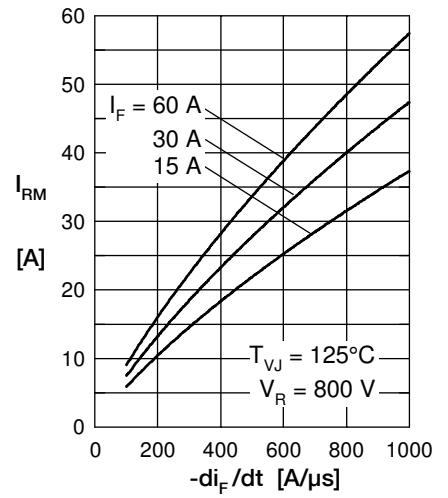

Fig. 3 Typ. peak reverse current I_{RM} versus $-di_F/dt$

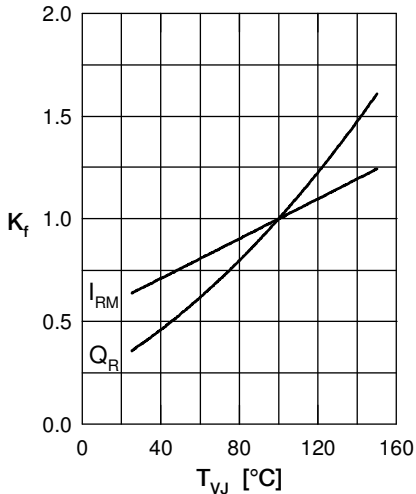

Fig. 4 Dynamic parameters Q_r , I_{RM} versus T_{VJ}

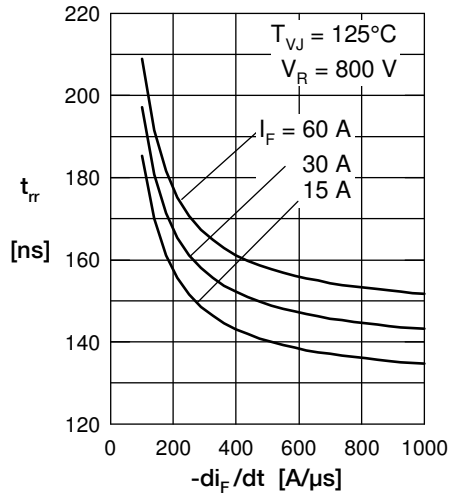

Fig. 5 Typ. recovery time t_{rr} versus $-di_F/dt$

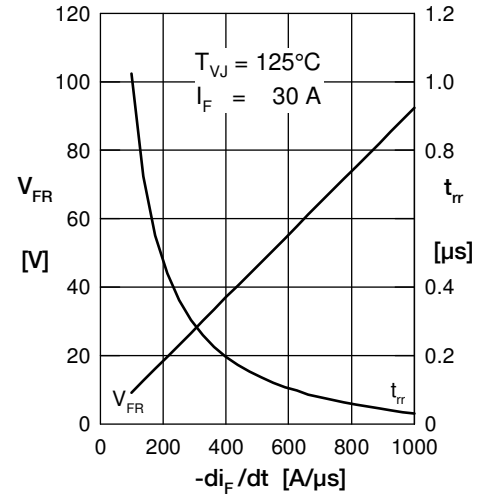

Fig. 6 Typ. peak forward voltage V_{FR} and t_{rr} versus di_F/dt

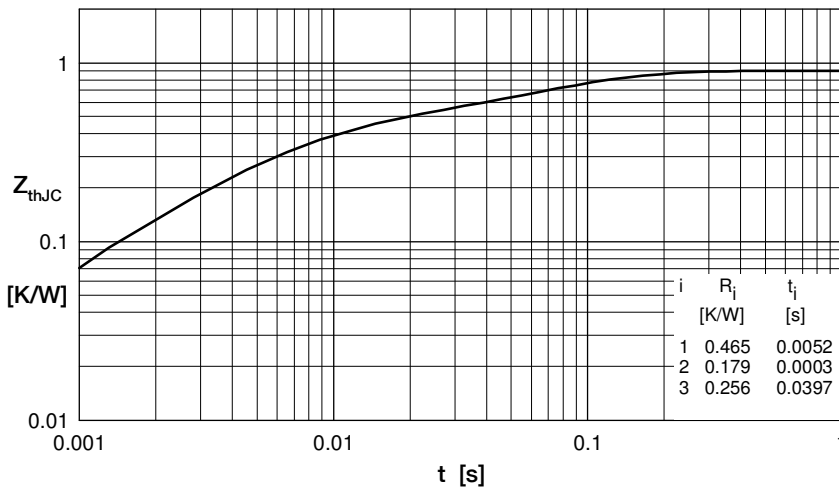

Fig. 7 Transient thermal impedance junction to case

Mouser Electronics

Authorized Distributor

Click to View Pricing, Inventory, Delivery & Lifecycle Information:

[IXYS:](#)

[VVZB135-16IOXT](#)