

Low Dropout, Negative Output Voltage Regulator

Features

- Low Dropout Voltage
 - Typically 120mV @ 50mA; 380mV @ 100mA for -5.0V Output Part
- Tight Output Voltage Tolerance: $\pm 2\%$ Max
- Low Supply Current: 3.5 μ A, Typ
- Small Package: 3-Pin SOT-23A

Applications

- Cellular Phones
- Battery Operated Systems
- Palmtops
- Portable Cameras

Device Selection Table

| Part Number | Output Voltage | Package | Temperature Range |
|-------------|----------------|---------------|-------------------|
| TC593002ECB | 3.0V | 3-Pin SOT-23A | -40°C to +85°C |
| TC595002ECB | 5.0V | 3-Pin SOT-23A | -40°C to +85°C |

Other output voltages are available. Please contact Microchip Technology Inc. for details.

Package Type

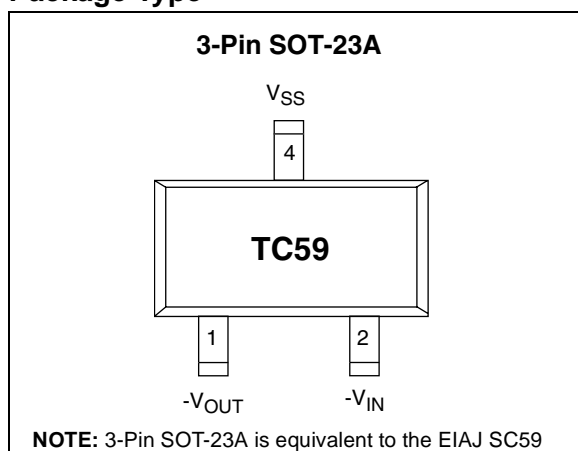

General Description

The TC59 is a low dropout, negative output voltage regulator designed specifically for battery-operated systems. Its full CMOS construction eliminates the wasted ground current typical of bipolar LDOs. This reduced supply current significantly extends battery life, particularly when the TC59 is operated in dropout.

Other TC59 key features include low supply current (typically 3.0 μ A) and low dropout operation (typically 120mV at 50mA). The TC59 is packaged in a small 3-Pin SOT-23A package.

Functional Block Diagram

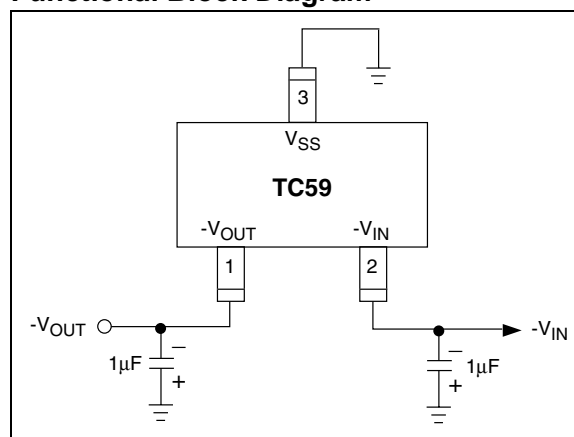

TC59

1.0 ELECTRICAL CHARACTERISTICS

Absolute Maximum Ratings*

| | |
|----------------------------------|-------------------------------------|
| Input Voltage | -12V |
| Output Current | 200mA |
| Output Voltage..... | $-V_{DD} - 0.3V$ to $V_{IN} + 0.3V$ |
| Power Dissipation..... | 150mW |
| Operating Temperature Range..... | -40°C to +85°C |
| Storage Temperature Range | -40°C to +125°C |

Stresses above those listed under "Absolute Maximum Ratings" may cause permanent damage to the device. These are stress ratings only and functional operation of the device at these or any other conditions above those indicated in the operation sections of the specifications is not implied. Exposure to Absolute Maximum Rating conditions for extended periods may affect device reliability.

TC59 ELECTRICAL SPECIFICATIONS

| Electrical Characteristics: $V_{IN} = V_R - 1.0V$ (Note 1), $C_L = 10\mu F$, $T_A = 25^\circ C$ unless otherwise noted. | | | | | | |
|--|--|----------------------------|--|--|----------------------------------|---|
| Symbol | Parameter | Min | Typ | Max | Units | Test Conditions |
| V_{IN} | Input Voltage | — | — | -10 | V | $I_{OUT} = 20mA$ |
| I_{DD} | Supply Current | — | 3 | 7 | μA | |
| $I_{OUT(MAX)}$ | Maximum Output Current | 100 80 60 | — — — | — — — | mA mA mA | $V_{IN} = -6.0V$; $V_R = -5.0V$, $V_{OUT} \leq -4.5V$ $V_{IN} = -5.0V$; $V_R = -4.0V$, $V_{OUT} \leq -3.6V$ $V_{IN} = -4.0V$; $V_R = -3.0V$, $V_{OUT} \leq -2.7V$ |
| V_{OUT} | Output Voltage | $1.02 \times V_R$ | — | $0.98 \times V_R$ | V | $I_{OUT} = 20mA$ |
| TC V_{OUT} | Output Voltage Temperature Coefficient | — | ± 100 | — | ppm/ $^\circ C$ | $I_{OUT} = 20mA$ |
| $\frac{\Delta V_{OUT}}{(\Delta V_{IN} \times V_{OUT})}$ | Line Regulation | — | 0.1 | 0.3 | %/V | $I_{OUT} = 20mA$; $V_R = -5.0V$; $-6.0 < V_{IN} < -10.0V$ $V_R = -4.0V$; $-5.0 < V_{IN} < -10.0V$ $V_R = -3.0V$; $-4.0 < V_{IN} < -10.0V$ |
| ΔV_{OUT} | Load Regulation | — | 40 | 80 | mV | $V_R = -5.0V$; $1mA < I_{OUT} < 50mA$ $V_R = -4.0V$; $1mA < I_{OUT} < 45mA$ $V_R = -3.0V$; $1mA < I_{OUT} < 40mA$ |
| $V_{IN} - V_{OUT}$ | Dropout Voltage | — — — — — — | 120 380 120 380 120 380 | 300 600 300 600 300 600 | mV mV mV mV mV mV | $V_R = -5.0V$; $I_{OUT} = 50mA$ $I_{OUT} = 100mA$ $V_R = -4.0V$; $I_{OUT} = 45mA$ $I_{OUT} = 90mA$ $V_R = -3.0V$; $I_{OUT} = 40mA$ $I_{OUT} = 80mA$ |

Note 1: V_R is the regulator output voltage setting. For example: $V_R = -2.5V, -2.7V, -3.0V, -3.3V, -3.6V, -4.0V, -5.0V$.

2.0 PIN DESCRIPTIONS

The descriptions of the pins are listed in Table 2-1.

TABLE 2-1: PIN FUNCTION TABLE

| Pin No. (3-Pin SOT-23A) | Symbol | Description |
|----------------------------|-----------|---------------------------|
| 1 | V_{OUT} | Regulated voltage output. |
| 2 | V_{IN} | Supply voltage input. |
| 3 | V_{SS} | Ground. |

3.0 DETAILED DESCRIPTION

The TC59 is a low quiescent current, precision fixed negative output voltage LDO. Unlike bipolar linear regulators, the TC59 supply current does not increase proportionally with load current.

3.1 Output Capacitor

A minimum of 1 μ F tantalum output capacitor is required. The requirements for the output capacitor are an equivalent series resistance (esr) greater than 0.1 Ω and less than 5 Ω , with a self-resonant frequency greater than 1MHz. To improve supply noise rejection and transient response, larger output capacitors can be used. Care should be taken when increasing C_{OUT} , that the input impedance is not high enough to cause high input impedance oscillation.

3.2 Input Capacitor

A 1 μ F input capacitor is recommended for most applications when the input impedance is on the order of 10 Ω . When operating off of a battery input, or there is a large distance from the input source to the LDO, larger input capacitance may be required for stability. When large values of output capacitance are used, the input capacitance should be increased to prevent high source impedance oscillations.

4.0 THERMAL CONSIDERATIONS

4.1 Power Dissipation

The amount of power dissipated internal to the low drop out linear regulator is the sum of the power dissipation within the linear pass device (P-Channel MOSFET), and the quiescent current required to bias the internal reference and error amplifier. The internal linear pass device power dissipation is calculated multiplying the voltage across the linear device times the current through the device. The input and output voltages are negative for the TC59. The power dissipation is calculated using the absolute value of the voltage difference between the input and output voltage.

TABLE 4-1: MAXIMUM POWER DISSIPATION

| Package Type | Maximum Power Dissipation |
|--------------|---------------------------|
| SOT-23-3 | 150mW |

EQUATION 4-1:

$$P_D (\text{Pass Device}) = (V_{IN} - V_{OUT}) \times I_{OUT}$$

The internal power dissipation as a result of the bias current for the LDO internal reference and error amplifier is calculated by multiplying the ground or quiescent current times the input voltage.

EQUATION 4-2:

$$P_D (\text{Bias}) = V_{IN} \times I_{GND}$$

The total internal power dissipation is the sum of Equation 4-1 and Equation 4-2.

EQUATION 4-3:

$$P_{TOTAL} = P_D (\text{Pass Device}) + P_D (\text{Bias})$$

For the TC59, the internal quiescent bias current is so low (3μA typical), the P_D (Bias) term of the power dissipation equation can be ignored. The maximum power dissipation can be estimated by using the maximum input voltage and the minimum output voltage to obtain a maximum voltage differential between input and output and multiplying the maximum voltage differential by the maximum output current.

EQUATION 4-4:

$$P_{MAX} = (V_{IN (MAX)} - V_{OUT (MIN)}) \times I_{OUT (MAX)}$$

For example, given the following conditions:

$$V_{IN} = -7.0V \pm 5\%$$

$$V_{OUT} = -5.0V \pm 2\%$$

$$I_{OUT} = 1mA \text{ to } 40mA$$

$$T_{AMBIENT (MAX)} = 55^\circ C$$

$$P_{MAX} = (7V \times (1.05) - (5.0V \times 0.98)) \times 40mA$$

$$P_{MAX} = 98.0 \text{ milli-Watts}$$

To determine the junction temperature of the device, the thermal resistance from junction to air must be known. The SOT-23-3 $R_{\theta JA}$ is estimated to be approximately 359°C/W when mounted on a 4-layer board. The $R_{\theta JA}$ will vary with physical layout, airflow and other application specific conditions.

The device junction temperature is determined by calculating the junction temperature rise above ambient, then adding the rise to the ambient temperature.

EQUATION 4-5: JUNCTION TEMPERATURE (SOT-23 EXAMPLE)

$$T_{JUNCTION} = P_D (MAX) \times R_{\theta JA} + T_{AMBIENT}$$

$$T_{JUNCTION} = 98.0 \text{ milli-Watts} \times 359^\circ C/W + 55^\circ C$$

$$T_{JUNCTION} = 90.2^\circ C$$

5.0 TYPICAL CHARACTERISTICS

Note: The graphs and tables provided following this note are a statistical summary based on a limited number of samples and are provided for informational purposes only. The performance characteristics listed herein are not tested or guaranteed. In some graphs or tables, the data presented may be outside the specified operating range (e.g., outside specified power supply range) and therefore outside the warranted range.

1. OUTPUT VOLTAGE vs. OUTPUT CURRENT

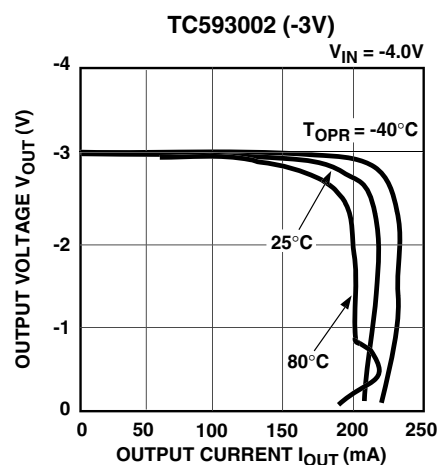
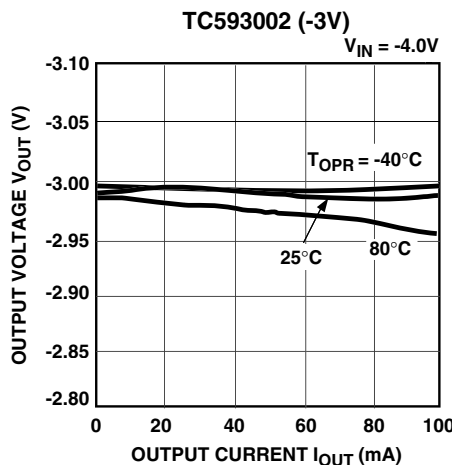
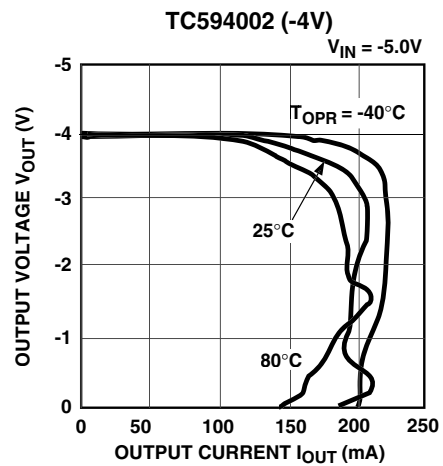
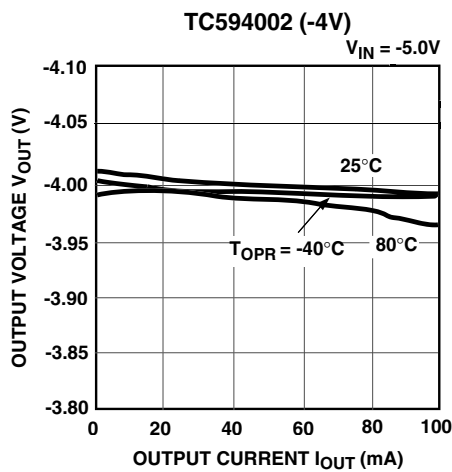
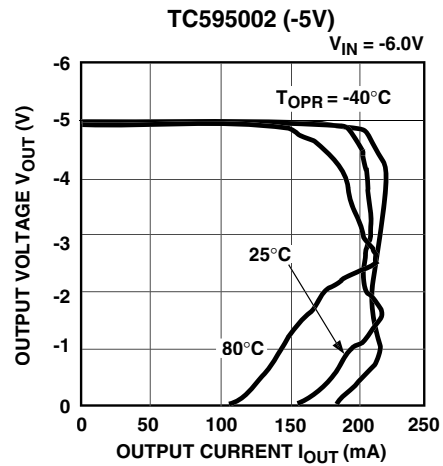
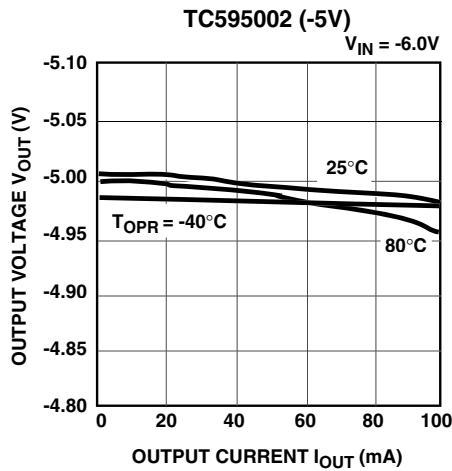

5.0 TYPICAL CHARACTERISTICS (CONTINUED)

2. OUTPUT VOLTAGE vs. INPUT VOLTAGE

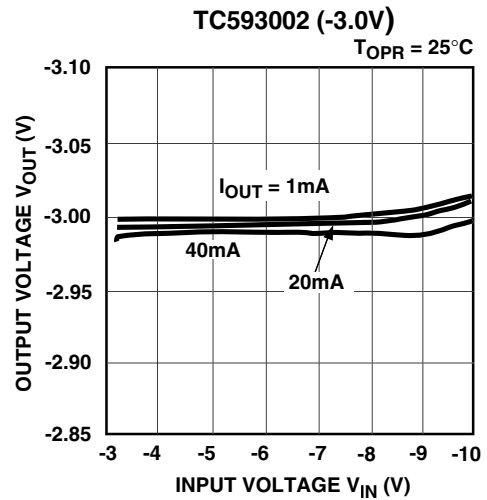
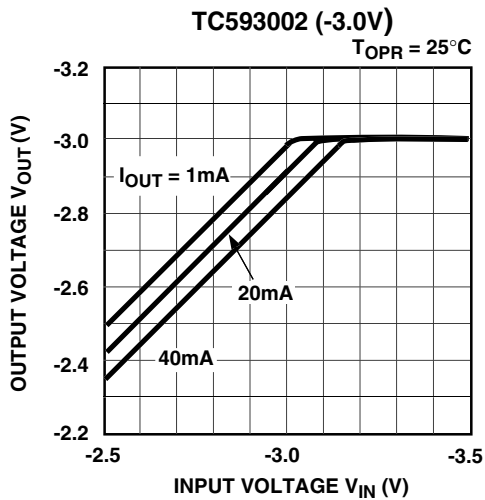
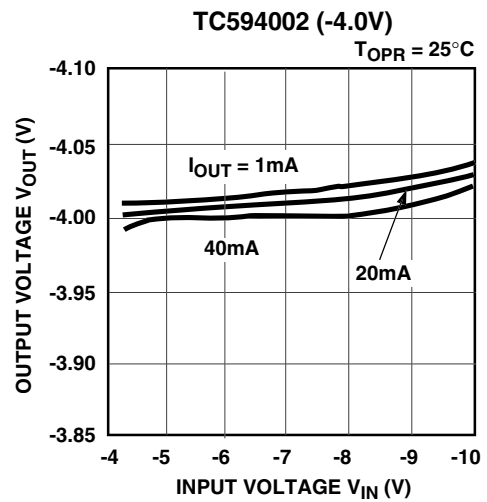
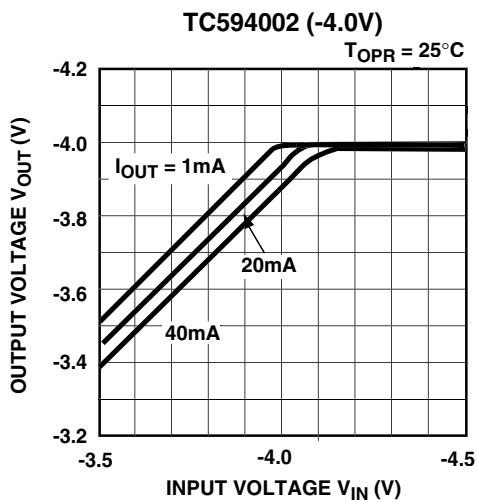
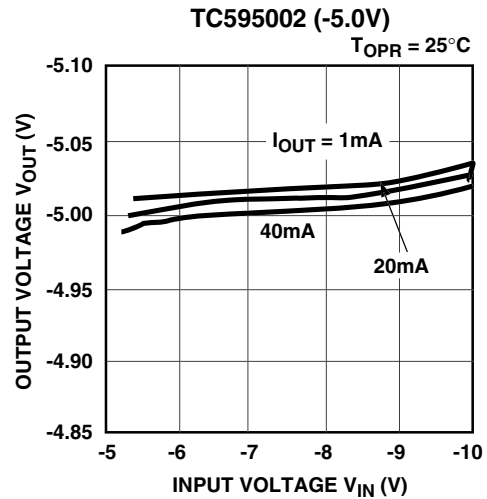
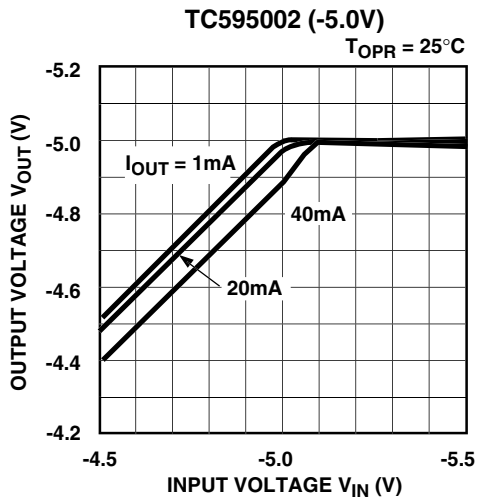

5.0 TYPICAL CHARACTERISTICS (CONTINUED)

3. INPUT/OUTPUT VOLTAGE DIFFERENTIAL vs. OUTPUT CURRENT

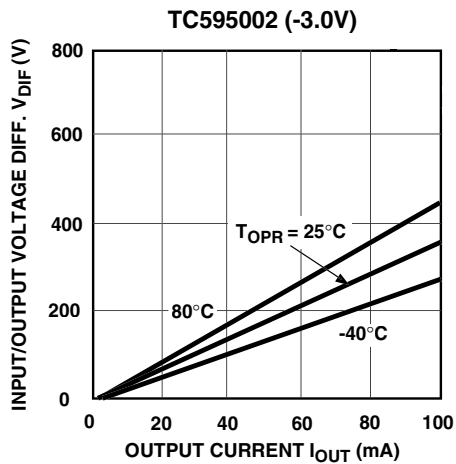
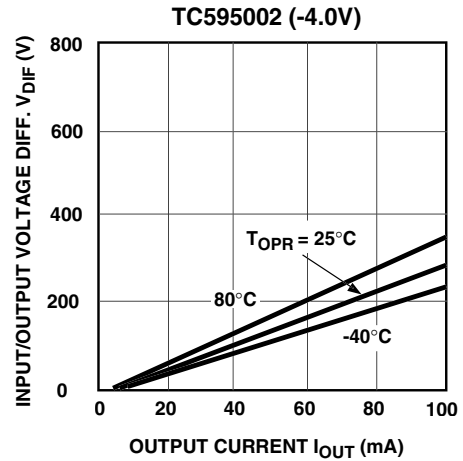
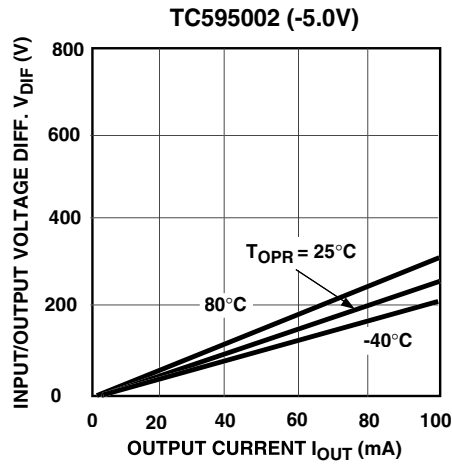

4. SUPPLY CURRENT vs. INPUT VOLTAGE

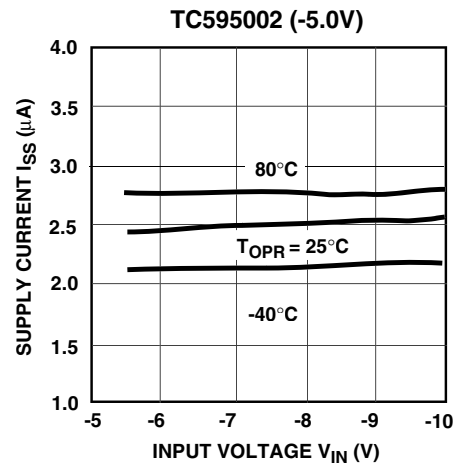
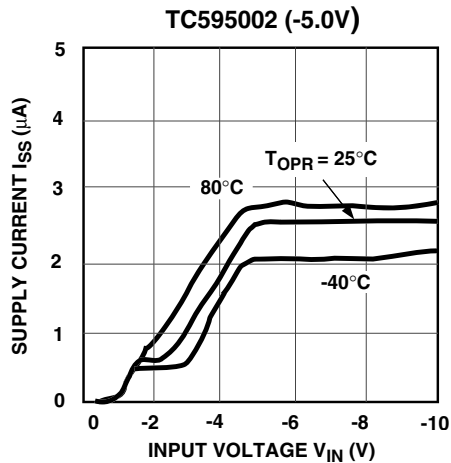

5.0 TYPICAL CHARACTERISTICS (CONTINUED)

4. SUPPLY CURRENT vs. INPUT VOLTAGE (CONTINUED)

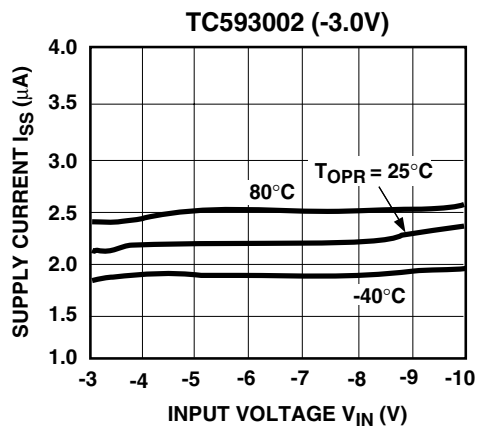
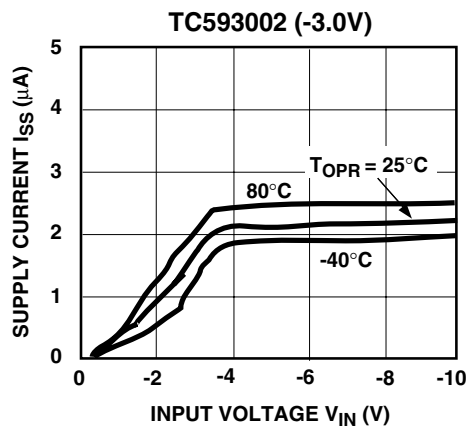
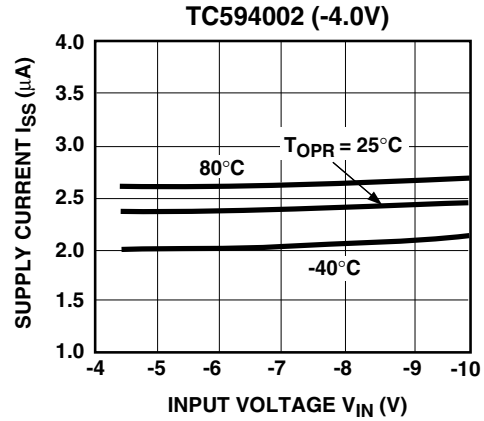
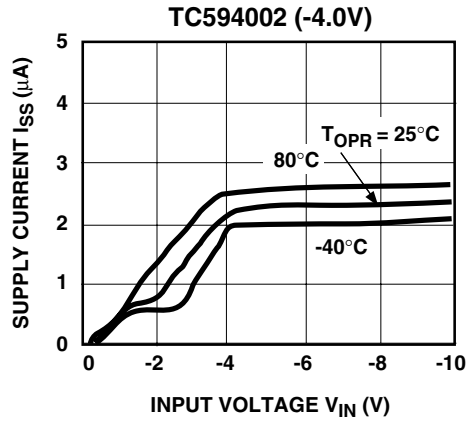

5. OUTPUT VOLTAGE vs. AMBIENT TEMPERATURE

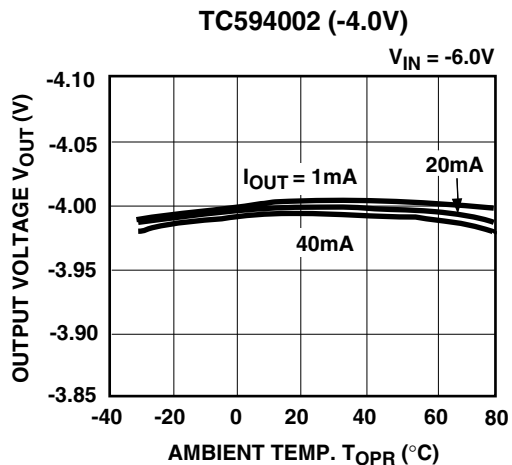
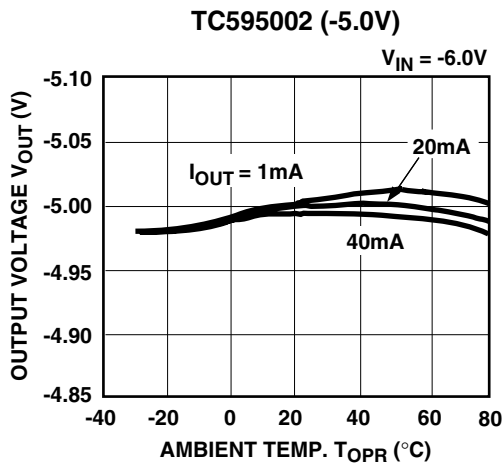

5.0 TYPICAL CHARACTERISTICS (CONTINUED)

5. OUTPUT VOLTAGE vs. AMBIENT TEMPERATURE (CONTINUED)

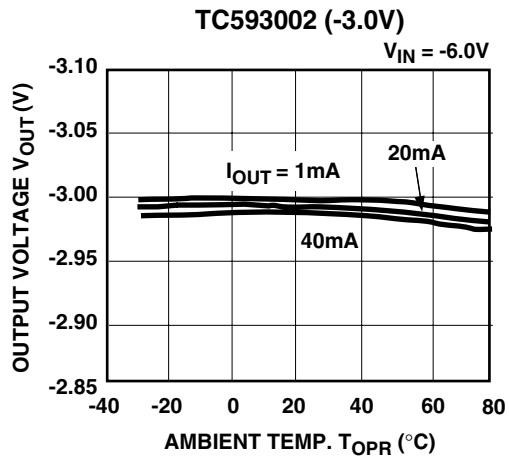

6. SUPPLY CURRENT vs. AMBIENT TEMPERATURE

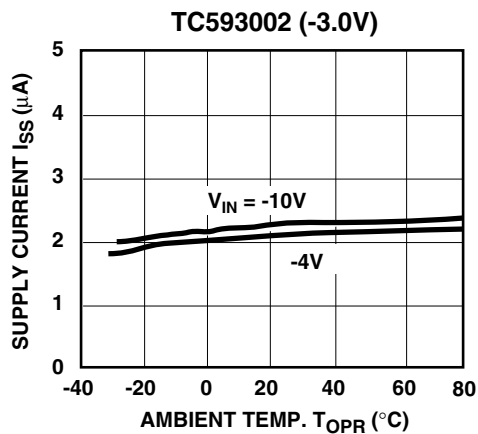
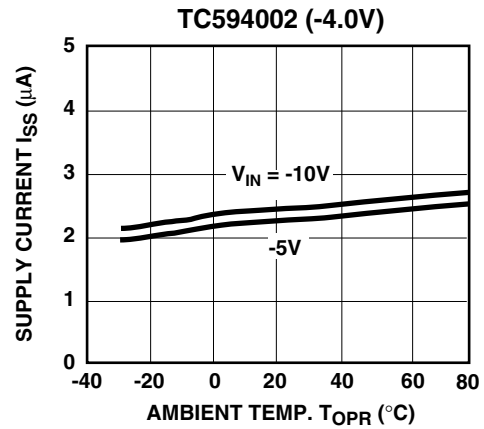
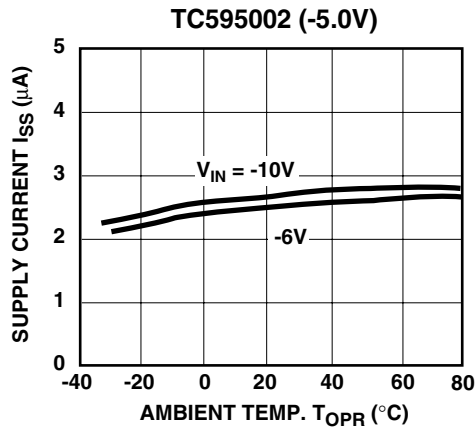

5.0 TYPICAL CHARACTERISTICS (CONTINUED)

7. INPUT TRANSIENT RESPONSE

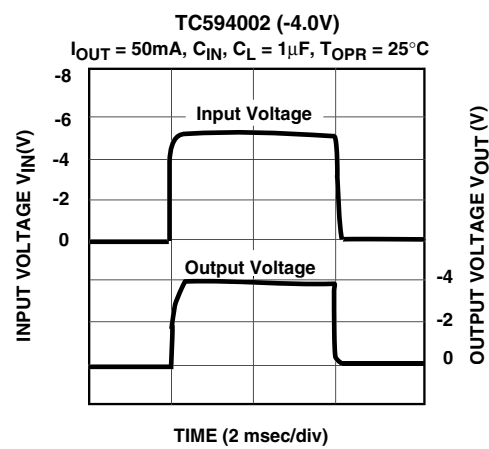
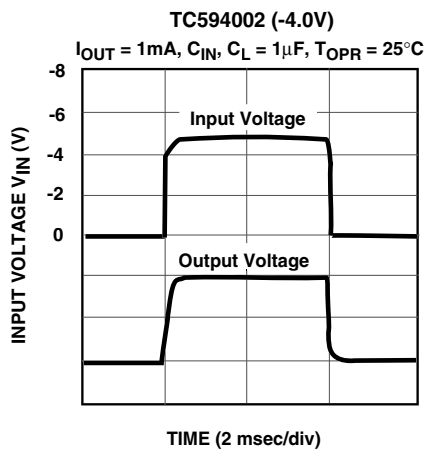
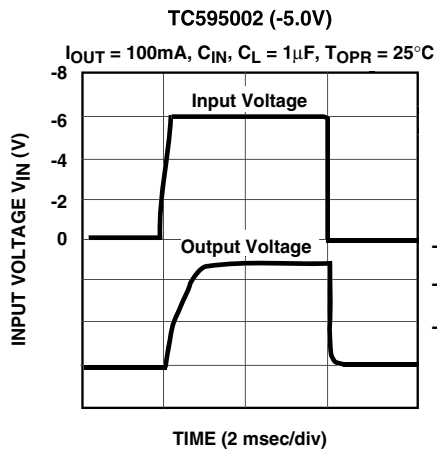
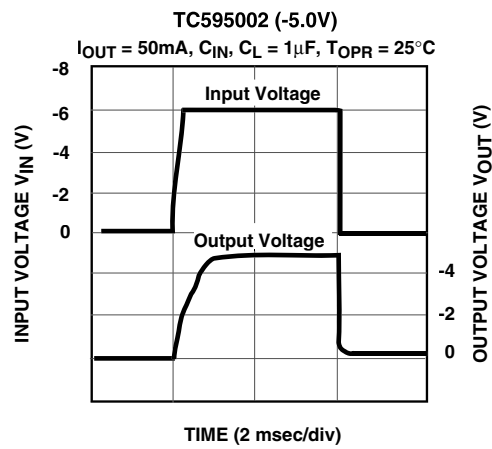
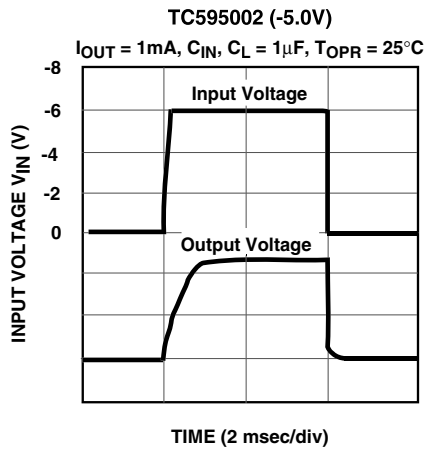

5.0 TYPICAL CHARACTERISTICS (CONTINUED)

7. INPUT TRANSIENT RESPONSE (CONT.)

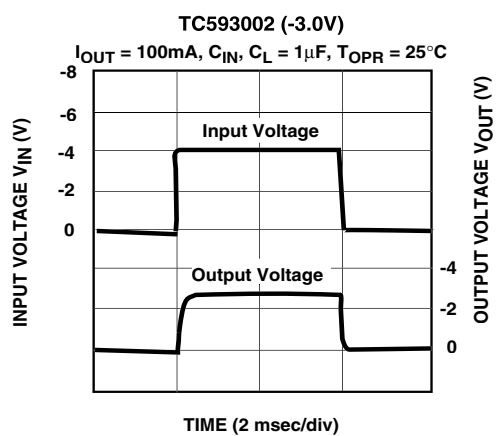
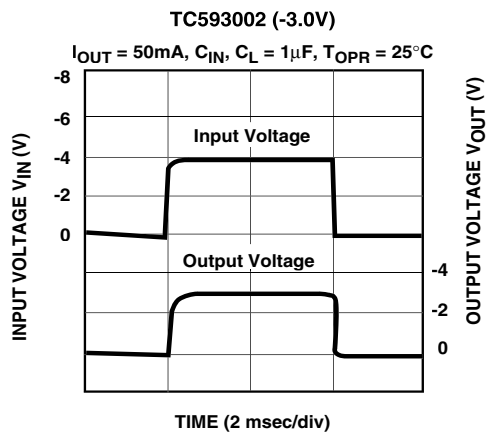
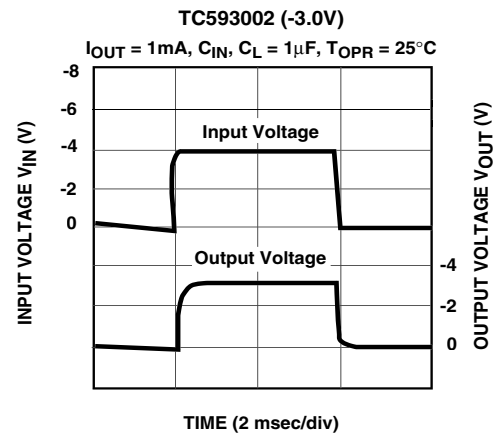
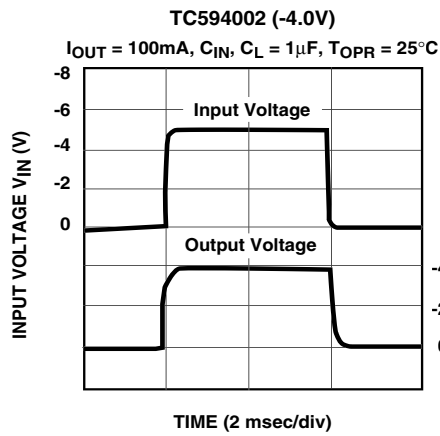

5.0 TYPICAL CHARACTERISTICS (CONTINUED)

8. LOAD TRANSIENT RESPONSE

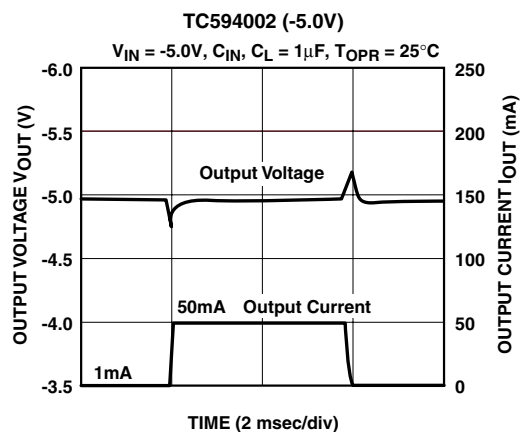
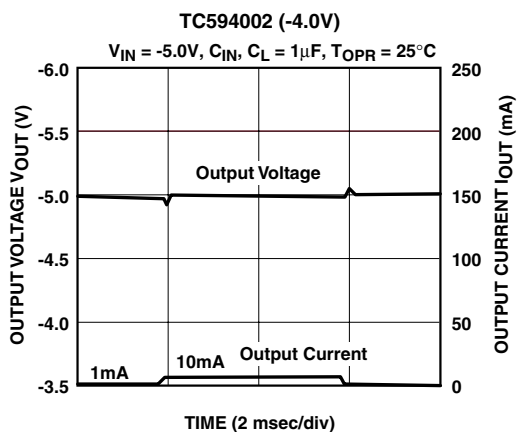
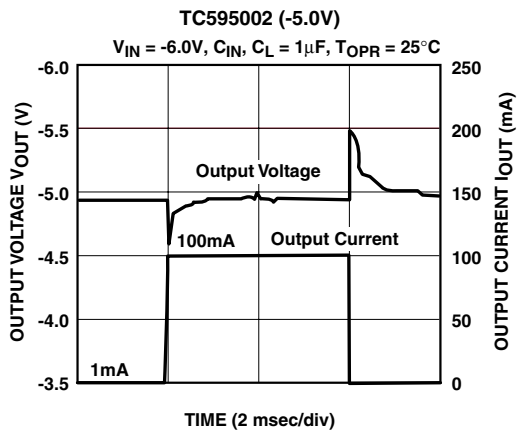
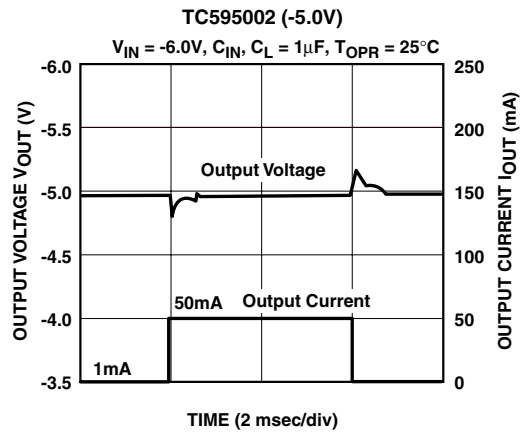
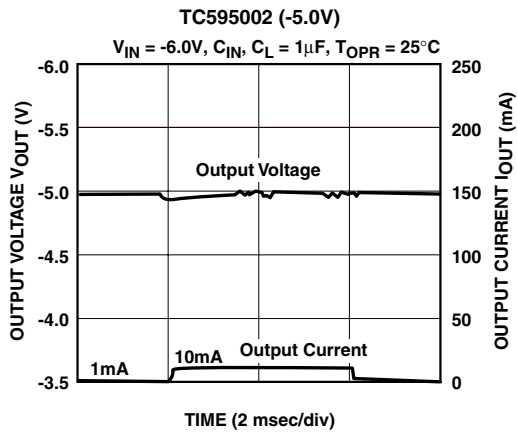

5.0 TYPICAL CHARACTERISTICS (CONTINUED)

8. LOAD TRANSIENT RESPONSE (CONT.)

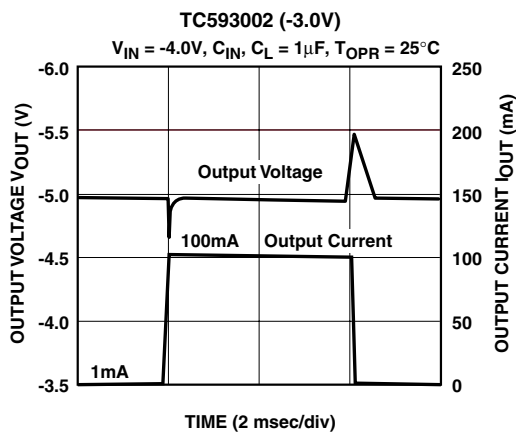
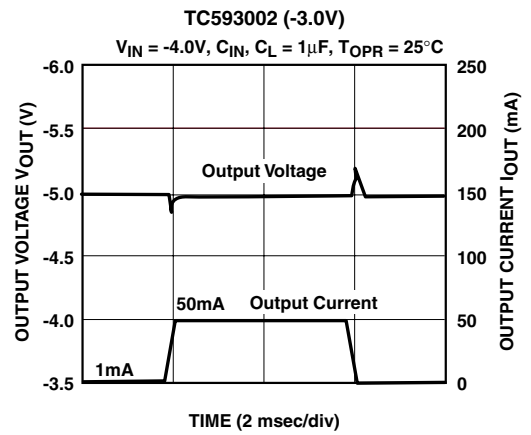
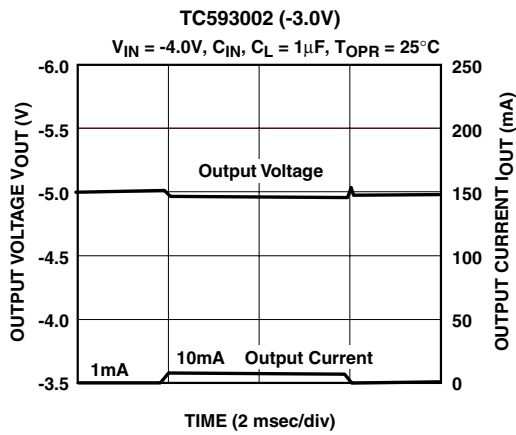
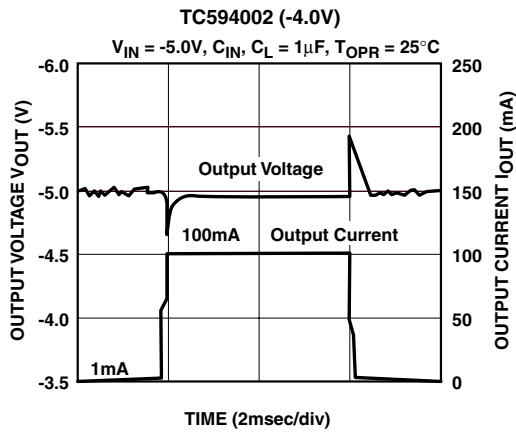

5.0 TYPICAL CHARACTERISTICS (CONTINUED)

9. RIPPLE REJECTION RATE

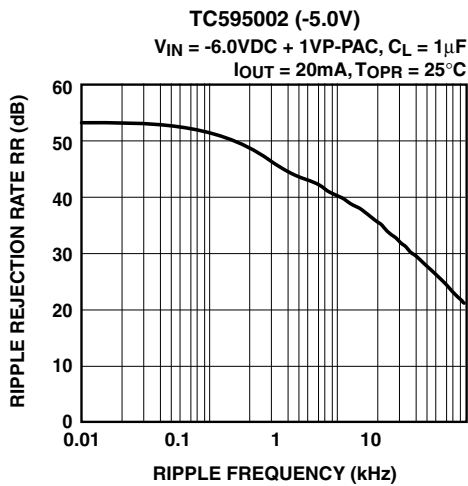
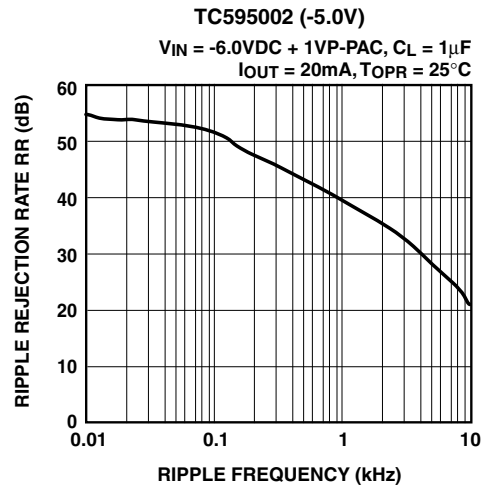
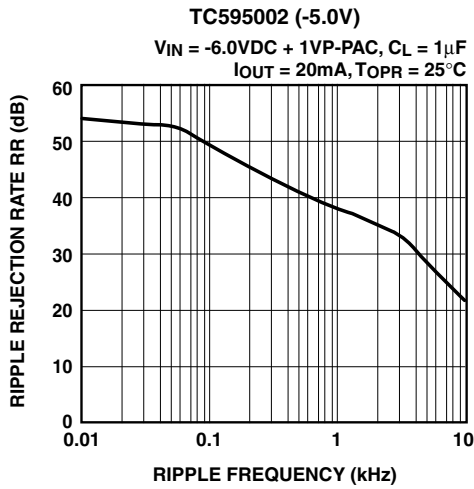

6.0 PACKAGING INFORMATION

6.1 Package Marking Information

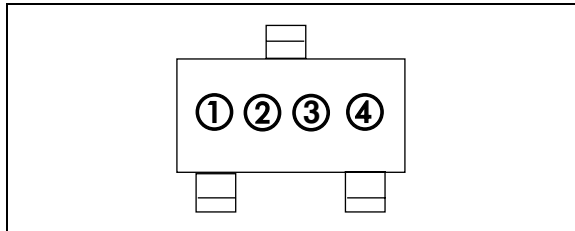

① represents first integer of output voltage

| Symbol | Voltage |
|--------|---------|
| 0 | 0. |
| 1 | 1. |
| 2 | 2. |
| 3 | 3. |
| 4 | 4. |
| 5 | 5. |
| 6 | 6. |
| 7 | 7. |
| 8 | 8. |
| 9 | 9. |

② represents first decimal of output voltage

| Symbol | Voltage | Symbol | Voltage |
|--------|---------|--------|---------|
| A | .0 | F | .5 |
| B | .1 | H | .6 |
| C | .2 | K | .7 |
| D | .3 | L | .8 |
| E | .4 | M | .9 |

③ represents voltage polarity

| Symbol | Polarity |
|--------|----------|
| 5 | - |

④ represents assembly lot code

6.2 Taping Form

Component Taping Orientation for 3-Pin SOT-23A (EIAJ SC-59) Devices

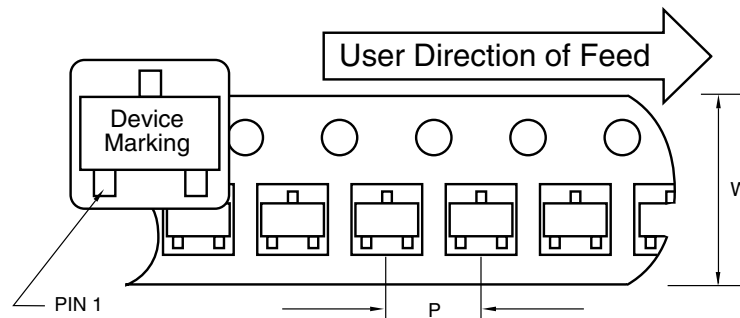

Standard Reel Component Orientation
for TR Suffix Device
(Mark Right Side Up)

Carrier Tape, Number of Components Per Reel and Reel Size

| Package | Carrier Width (W) | Pitch (P) | Part Per Full Reel | Reel Size |
|---------------|-------------------|-----------|--------------------|-----------|
| 3-Pin SOT-23A | 8 mm | 4 mm | 3000 | 7 in |

6.3 Package Dimensions

SOT-23A-3

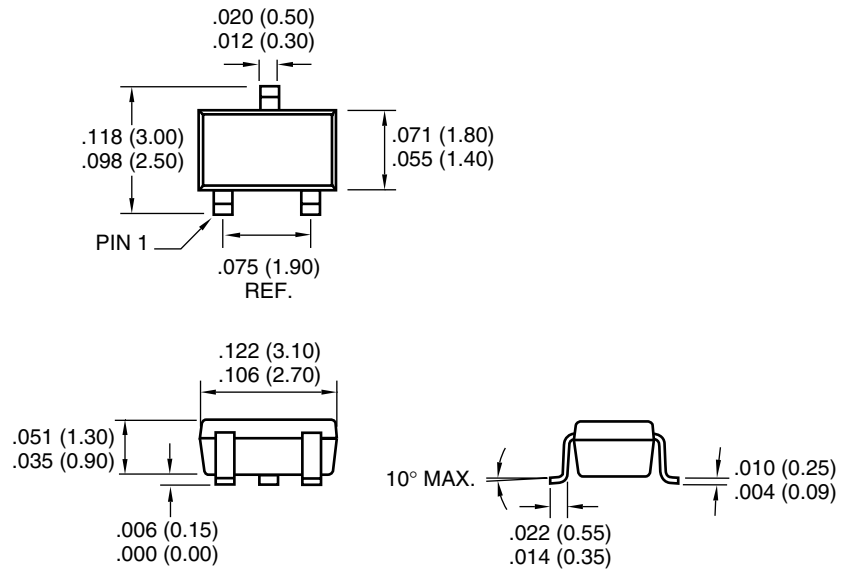

Dimensions: inches (mm)

PRODUCT IDENTIFICATION SYSTEM

To order or obtain information, e.g., on pricing or delivery, refer to the factory or the listed sales office.

| | | | | | |
|-----------------------------|---------------------------------|-----------|-----------|------------|-----------|
| PART CODE | TC59 | 30 | 02 | ECB | XX |
| | TC59 | 50 | 02 | ECB | XX |
| Output Voltage: | _____ | | | | |
| | 50 = -5.0V; 30 = -3.0V | | | | |
| Tolerance: | _____ | | | | |
| | 02 = 2% | | | | |
| Temperature/Package: | _____ | | | | |
| | -40°C to +85°C 3-Pin SOT-23A | | | | |
| Taping Direction: | _____ | | | | |
| | TR: Standard Taping | | | | |

Sales and Support

Data Sheets

Products supported by a preliminary Data Sheet may have an errata sheet describing minor operational differences and recommended workarounds. To determine if an errata sheet exists for a particular device, please contact one of the following:

1. Your local Microchip sales office
2. The Microchip Corporate Literature Center U.S. FAX: (480) 792-7277
3. The Microchip Worldwide Site (www.microchip.com)

Please specify which device, revision of silicon and Data Sheet (include Literature #) you are using.

New Customer Notification System

Register on our web site (www.microchip.com/cn) to receive the most current information on our products.

TC59

NOTES:

Information contained in this publication regarding device applications and the like is intended through suggestion only and may be superseded by updates. It is your responsibility to ensure that your application meets with your specifications. No representation or warranty is given and no liability is assumed by Microchip Technology Incorporated with respect to the accuracy or use of such information, or infringement of patents or other intellectual property rights arising from such use or otherwise. Use of Microchip's products as critical components in life support systems is not authorized except with express written approval by Microchip. No licenses are conveyed, implicitly or otherwise, under any intellectual property rights.

Trademarks

The Microchip name and logo, the Microchip logo, FilterLab, KEELOQ, microID, MPLAB, PIC, PICmicro, PICMASTER, PICSTART, PRO MATE, SEEVAL and The Embedded Control Solutions Company are registered trademarks of Microchip Technology Incorporated in the U.S.A. and other countries.

dsPIC, ECONOMONITOR, FanSense, FlexROM, fuzzyLAB, In-Circuit Serial Programming, ICSP, ICEPIC, microPort, Migratable Memory, MPASM, MPLIB, MPLINK, MPSIM, MXDEV, MXLAB, PICC, PICDEM, PICDEM.net, rPIC, Select Mode and Total Endurance are trademarks of Microchip Technology Incorporated in the U.S.A.

Serialized Quick Turn Programming (SQTP) is a service mark of Microchip Technology Incorporated in the U.S.A.

All other trademarks mentioned herein are property of their respective companies.

© 2002, Microchip Technology Incorporated, Printed in the U.S.A., All Rights Reserved.

 Printed on recycled paper.

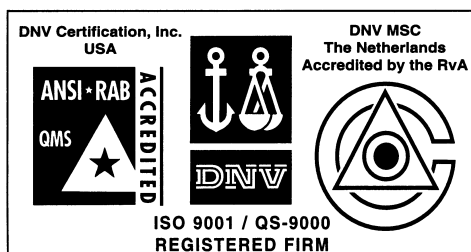

Microchip received QS-9000 quality system certification for its worldwide headquarters, design and wafer fabrication facilities in Chandler and Tempe, Arizona in July 1999 and Mountain View, California in March 2002. The Company's quality system processes and procedures are QS-9000 compliant for its PICmicro® 8-bit MCUs, KEELOQ® code hopping devices, Serial EEPROMs, microperipherals, non-volatile memory and analog products. In addition, Microchip's quality system for the design and manufacture of development systems is ISO 9001 certified.



MICROCHIP

WORLDWIDE SALES AND SERVICE

AMERICAS

Corporate Office

2355 West Chandler Blvd.
Chandler, AZ 85224-6199
Tel: 480-792-7200 Fax: 480-792-7277
Technical Support: 480-792-7627
Web Address: <http://www.microchip.com>

Rocky Mountain

2355 West Chandler Blvd.
Chandler, AZ 85224-6199
Tel: 480-792-7966 Fax: 480-792-7456

Atlanta

500 Sugar Mill Road, Suite 200B
Atlanta, GA 30350
Tel: 770-640-0034 Fax: 770-640-0307

Boston

2 Lan Drive, Suite 120
Westford, MA 01886
Tel: 978-692-3848 Fax: 978-692-3821

Chicago

333 Pierce Road, Suite 180
Itasca, IL 60143
Tel: 630-285-0071 Fax: 630-285-0075

Dallas

4570 Westgrove Drive, Suite 160
Addison, TX 75001
Tel: 972-818-7423 Fax: 972-818-2924

Detroit

Tri-Atria Office Building
32255 Northwestern Highway, Suite 190
Farmington Hills, MI 48334
Tel: 248-538-2250 Fax: 248-538-2260

Kokomo

2767 S. Albright Road
Kokomo, Indiana 46902
Tel: 765-864-8360 Fax: 765-864-8387

Los Angeles

18201 Von Karman, Suite 1090
Irvine, CA 92612
Tel: 949-263-1888 Fax: 949-263-1338

New York

150 Motor Parkway, Suite 202
Hauppauge, NY 11788
Tel: 631-273-5305 Fax: 631-273-5335

San Jose

Microchip Technology Inc.
2107 North First Street, Suite 590
San Jose, CA 95131
Tel: 408-436-7950 Fax: 408-436-7955

Toronto

6285 Northam Drive, Suite 108
Mississauga, Ontario L4V 1X5, Canada
Tel: 905-673-0699 Fax: 905-673-6509

ASIA/PACIFIC

Australia

Microchip Technology Australia Pty Ltd
Suite 22, 41 Rawson Street
Epping 2121, NSW
Australia
Tel: 61-2-9868-6733 Fax: 61-2-9868-6755

China - Beijing

Microchip Technology Consulting (Shanghai)
Co., Ltd., Beijing Liaison Office
Unit 915
Bei Hai Wan Tai Bldg.
No. 6 Chaoyangmen Beidajie
Beijing, 100027, No. China
Tel: 86-10-85282100 Fax: 86-10-85282104

China - Chengdu

Microchip Technology Consulting (Shanghai)
Co., Ltd., Chengdu Liaison Office
Rm. 2401, 24th Floor,
Ming Xing Financial Tower
No. 88 TIDU Street
Chengdu 610016, China
Tel: 86-28-86766200 Fax: 86-28-86766599

China - Fuzhou

Microchip Technology Consulting (Shanghai)
Co., Ltd., Fuzhou Liaison Office
Unit 28F, World Trade Plaza
No. 71 Wusi Road
Fuzhou 350001, China
Tel: 86-591-7503506 Fax: 86-591-7503521

China - Shanghai

Microchip Technology Consulting (Shanghai)
Co., Ltd.
Room 701, Bldg. B
Far East International Plaza
No. 317 Xian Xia Road
Shanghai, 200051
Tel: 86-21-6275-5700 Fax: 86-21-6275-5060

China - Shenzhen

Microchip Technology Consulting (Shanghai)
Co., Ltd., Shenzhen Liaison Office
Rm. 1315, 13/F, Shenzhen Kerry Centre,
Renminnan Lu
Shenzhen 518001, China
Tel: 86-755-2350361 Fax: 86-755-2366086

China - Hong Kong SAR

Microchip Technology Hongkong Ltd.
Unit 901-6, Tower 2, Metroplaza
223 Hing Fong Road
Kwai Fong, N.T., Hong Kong
Tel: 852-2401-1200 Fax: 852-2401-3431

India

Microchip Technology Inc.
India Liaison Office
Divyasree Chambers
1 Floor, Wing A (A3/A4)
No. 11, O'Shaugnessey Road
Bangalore, 560 025, India
Tel: 91-80-2290061 Fax: 91-80-2290062

Japan

Microchip Technology Japan K.K.
Benex S-1 6F
3-18-20, Shinyokohama
Kohoku-Ku, Yokohama-shi
Kanagawa, 222-0033, Japan
Tel: 81-45-471-6166 Fax: 81-45-471-6122

Korea

Microchip Technology Korea
168-1, Youngbo Bldg. 3 Floor
Samsung-Dong, Kangnam-Ku
Seoul, Korea 135-882
Tel: 82-2-554-7200 Fax: 82-2-558-5934

Singapore

Microchip Technology Singapore Pte Ltd.
200 Middle Road
#07-02 Prime Centre
Singapore, 188980
Tel: 65-6334-8870 Fax: 65-6334-8850

Taiwan

Microchip Technology Taiwan
11F-3, No. 207
Tung Hua North Road
Taipei, 105, Taiwan
Tel: 886-2-2717-7175 Fax: 886-2-2545-0139

EUROPE

Denmark

Microchip Technology Nordic ApS
Regus Business Centre
Lautrup høj 1-3
Ballerup DK-2750 Denmark
Tel: 45 4420 9895 Fax: 45 4420 9910

France

Microchip Technology SARL
Parc d'Activite du Moulin de Massy
43 Rue du Saule Trapu
Batiment A - 1er Etage
91300 Massy, France
Tel: 33-1-69-53-63-20 Fax: 33-1-69-30-90-79

Germany

Microchip Technology GmbH
Gustav-Heinemann Ring 125
D-81739 Munich, Germany
Tel: 49-89-627-144 0 Fax: 49-89-627-144-44

Italy

Microchip Technology SRL
Centro Direzionale Colleoni
Palazzo Taurus 1 V. Le Colleoni 1
20041 Agrate Brianza
Milan, Italy
Tel: 39-039-65791-1 Fax: 39-039-6899883

United Kingdom

Microchip Ltd.
505 Eskdale Road
Winnersh Triangle
Wokingham
Berkshire, England RG41 5TU
Tel: 44 118 921 5869 Fax: 44-118 921-5820

05/01/02



Mouser Electronics

Authorized Distributor

Click to View Pricing, Inventory, Delivery & Lifecycle Information:

[Microchip:](#)

[TC595002ECBTR](#) [TC593002ECBTR](#)