



MAQ5300

Automotive Qualified Single Output 300mA μ Cap LDO

General Description

The MAQ5300 is an automotive-qualified, ultra-small, ultra-low dropout CMOS regulator (ULDO) that is ideal for today's most demanding automotive applications including infotainment, camera module, image sensors, and anywhere PCB space is limited. It offers extremely low dropout voltage, very low output noise and can operate from a 2.3V to 5.5V input while delivering up to 300mA.

The MAQ5300 offers 2% initial accuracy, low ground current (typically 85 μ A total), thermal shutdown, and current-limit protection. The MAQ5300 can also be put into a zero-off-mode current state, drawing no current when disabled.

The MAQ5300's operating junction temperature range is -40°C to $+125^{\circ}\text{C}$ and it is available in fixed output voltages in a lead-free (RoHS-compliant) 6-pin 2mm x 2mm DFN package.

Datasheets and support documentation are available on Micrel's website at: www.micrel.com.

Features

- Small 2mm x 2mm DFN package
- Low dropout voltage: 100mV at 300mA
- Output noise 120 μV_{RMS}
- Input voltage range: 2.3V to 5.5V
- 300mA guaranteed output current
- Stable with ceramic output capacitors
- Low quiescent current: 85 μA total
- 30 μs turn-on time
- High output accuracy
 - $\pm 2\%$ initial accuracy
 - $\pm 3\%$ over temperature
- Thermal shutdown and current-limit protection

Applications

- CMOS image sensors
- Backup camera modules
- GPS Receivers
- Infotainment

Typical Application

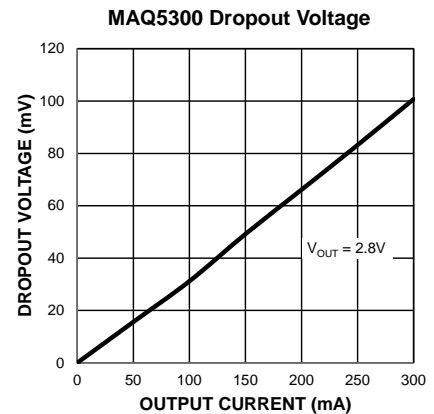
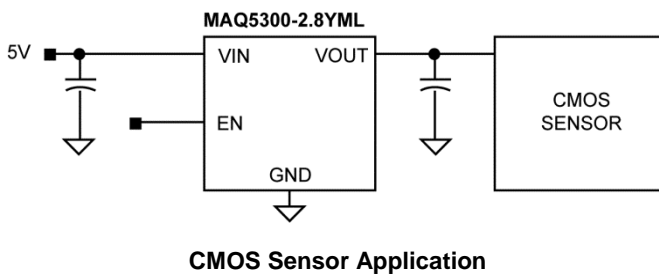

Ordering Information⁽¹⁾

Part Number	Marking Code	Voltage	Temperature Range	Package	Lead Finish
MAQ5300-1.5YML	QMF	1.5V	-40°C to +125°C	6-Pin 2mm x 2mm DFN	Pb-Free
MAQ5300-1.8YML	QMG	1.8V	-40°C to +125°C	6-Pin 2mm x 2mm DFN	Pb-Free
MAQ5300-2.5YML	QMJ	2.5V	-40°C to +125°C	6-Pin 2mm x 2mm DFN	Pb-Free
MAQ5300-2.8YML	QMM	2.8V	-40°C to +125°C	6-Pin 2mm x 2mm DFN	Pb-Free
MAQ5300-2.85YML	QMN	2.85V	-40°C to +125°C	6-Pin 2mm x 2mm DFN	Pb-Free
MAQ5300-3.0YML	QMP	3.0V	-40°C to +125°C	6-Pin 2mm x 2mm DFN	Pb-Free
MAQ5300-3.3YML	QMS	3.3V	-40°C to +125°C	6-Pin 2mm x 2mm DFN	Pb-Free

Note:

- Other voltages are available. Contact Micrel for details.

Pin Configuration

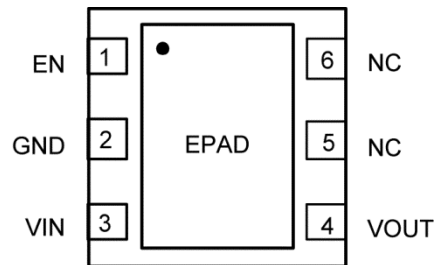

6-Pin 2mm x 2mm DFN (ML)
(Top View)

Pin Description

Pin Number	Pin Name	Pin Function
1	EN	Enable (Input): Active High. High = on, low = off. Do not leave this pin floating.
2	GND	Power Ground.
3	VIN	Supply Voltage (Input): Decouple with a minimum 1 μ F ceramic capacitor.
4	VOUT	Regulated Output Voltage (Output): Decouple with a minimum 1 μ F ceramic capacitor.
5	NC	No Connection.
6	NC	No Connection.
EPAD	EPAD	Exposed pad heat sink. Internally connected to ground. Connect to ground copper on board to lower thermal resistance.

Absolute Maximum Ratings⁽²⁾

Supply Voltage (V_{IN})	0V to +6V
Enable Input (V_{EN})	0V to $V_{IN}+0.3V$
Power Dissipation ⁽⁴⁾	Internally Limited
Lead Temperature (soldering, 10s)	260°C
Storage Temperature (T_S)	-65°C to +150°
ESD Rating	
HBM ⁽⁵⁾	2kV
MM	100V

Operating Ratings⁽³⁾

Supply Voltage (V_{IN})	+2.3V to +5.5V
Enable Input (V_{EN})	0V to V_{IN}
Ambient Temperature (T_A)	-40°C to +125°C
Junction Temperature (T_J)	-40°C to +125°C
Junction Thermal Resistance	
6-pin 2mm x 2mm DFN (θ_{JA})	90°C/W

Electrical Characteristics⁽⁶⁾

$V_{IN} = V_{OUT}+1V$; $C_{OUT} = 1.0\mu F$; $I_{OUT} = 100\mu A$; $T_J = 25^\circ C$, **bold** values indicate $-40^\circ C \leq T_J \leq +125^\circ C$, unless noted.

Parameter	Condition	Min.	Typ.	Max.	Units
Output Voltage Accuracy	Variation from nominal V_{OUT}	-2		+2	%
	Variation from nominal V_{OUT} ; -40°C to +125°C	-3		+3	%
Line Regulation	$V_{IN} = V_{OUT} + 1V$ to 5.5V; $I_{OUT} = 100\mu A$		0.02	0.6	%/V
Load Regulation ⁽⁷⁾	$I_{OUT} = 100\mu A$ to 300mA		0.03	0.6	%
Dropout Voltage ⁽⁸⁾	$I_{OUT} = 150mA$		50	100	mV
	$I_{OUT} = 300mA$		100	200	mV
Ground Pin Current ⁽⁹⁾	$I_{OUT} = 0$ to 300mA, EN = High		85	120	μA
Ground Pin Current in Shutdown	$V_{EN} = 0V$		0.1	1	μA
Ripple Rejection	f = up to 1kHz; $C_{OUT} = 1.0\mu F$		65		dB
	f = 1kHz to 20kHz; $C_{OUT} = 1.0\mu F$		42		dB
Current Limit	$V_{OUT} = 0V$	325	650	875	mA
Output Voltage Noise	$C_{OUT} = 1\mu F$, 10Hz to 100kHz		120		μV_{RMS}
Enable Input					
Enable Input Voltage	Logic Low			0.2	V
	Logic High	1.1			V
Enable Input Current	$V_{IL} \leq 0.2V$		0.01		μA
	$V_{IH} \geq 1.0V$		0.01		μA
Turn-on Time	$C_{OUT} = 1.0\mu F$		30	100	μs
Thermal Protection					
Over-temperature Shutdown	T_J Rising		155		°C
Over-temperature Shutdown Hysteresis			5		°C

Notes:

- Exceeding the absolute maximum ratings may damage the device.
- The device is not guaranteed to function outside its operating ratings.
- The maximum allowable power dissipation for any T_A (ambient temperature) is $P_{D(max)} = (T_{J(max)} - T_A) / \theta_{JA}$. Exceeding the maximum allowable power dissipation will result in excessive die temperature, and the regulator will go into thermal shutdown.
- Devices are ESD sensitive. Handling precautions are recommended. Human body model, 1.5k Ω in series with 100pF.
- Specification for packaged product only.
- Regulation is measured at constant junction temperature using low duty cycle pulse testing. Changes in output voltage due to heating effects are covered by the thermal regulation specification.
- Dropout voltage is defined as the input-to-output differential at which the output voltage drops 2% below its nominal value measured at 1V differential.
- Ground pin current is the regulator quiescent current. The total current drawn from the supply is the sum of the load current plus the ground pin current.

Typical Characteristics

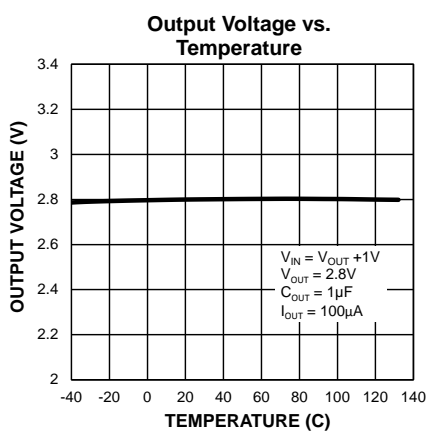
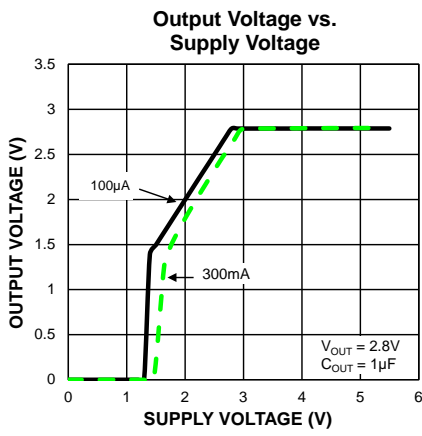
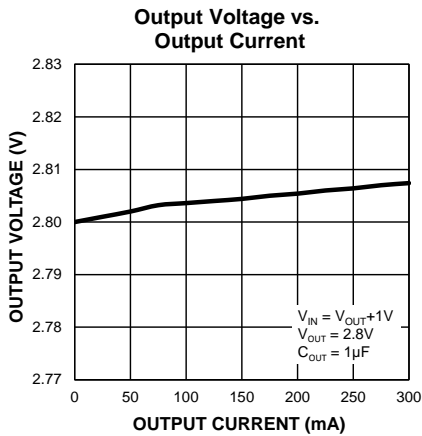
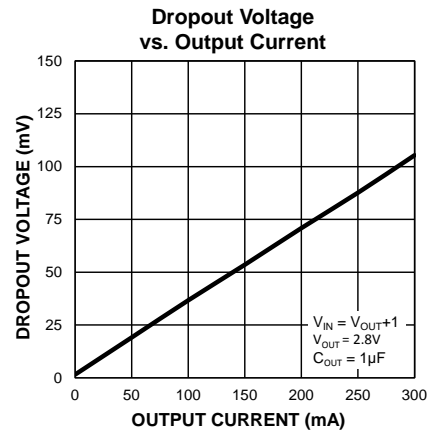
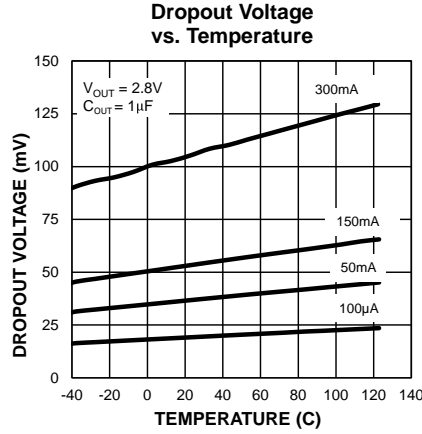
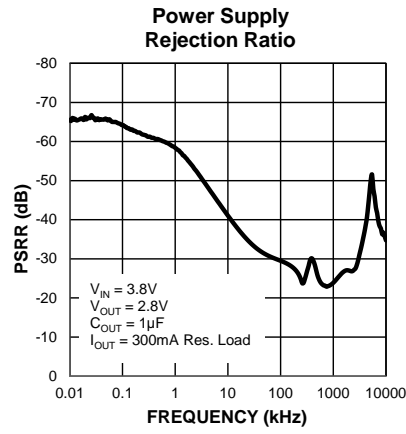
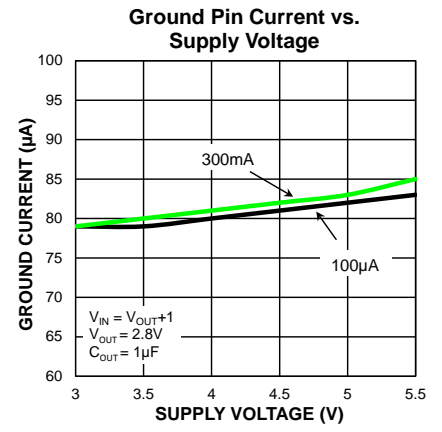
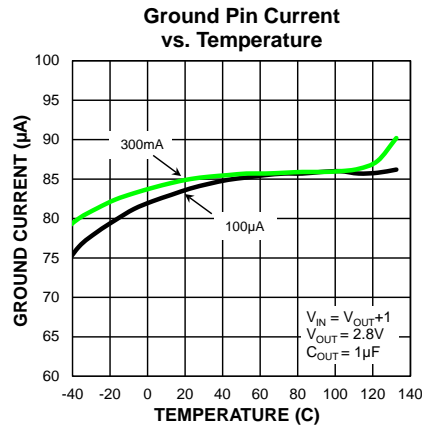
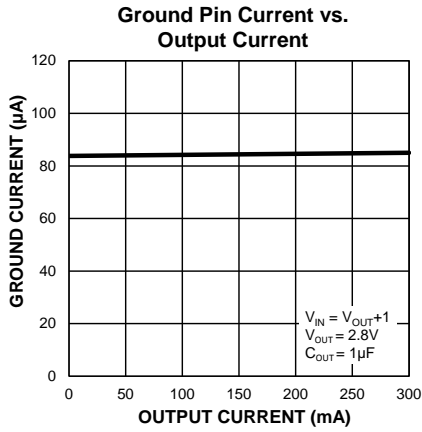

Typical Characteristics (Continued)

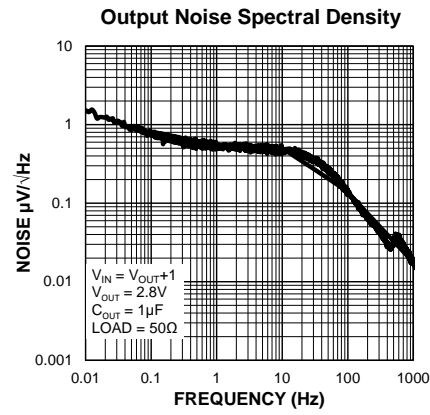
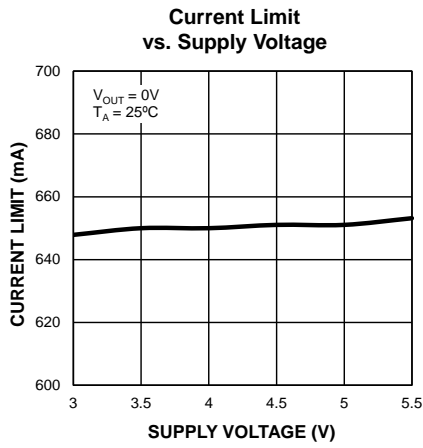

Functional Characteristics

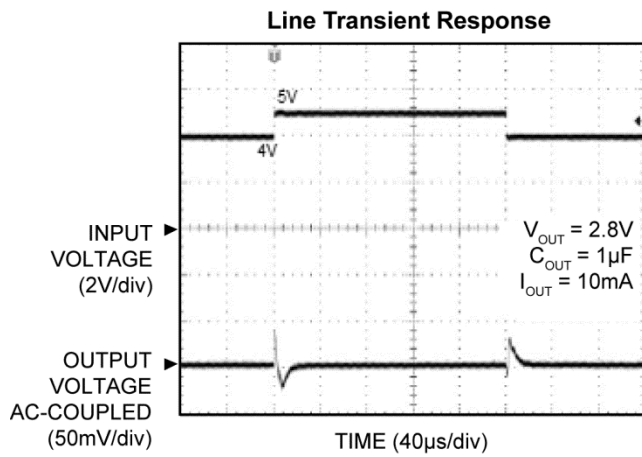
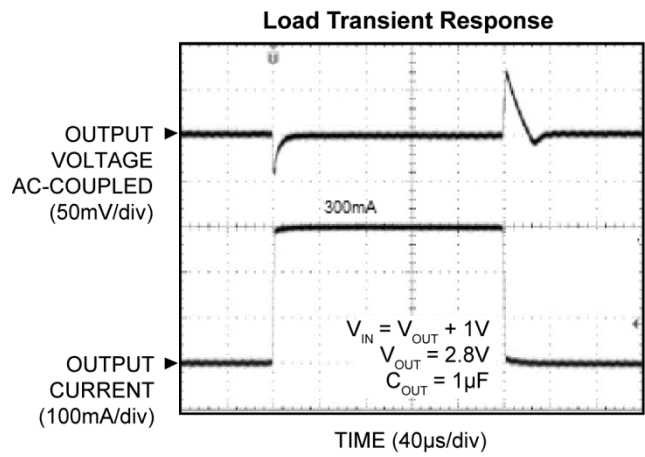
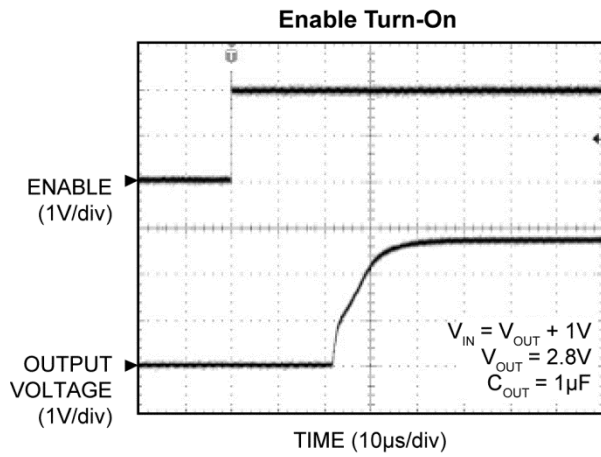

Application Information

Enable/Shutdown

The MAQ5300 comes with an active-high enable pin that allows the regulator to be disabled. Forcing the enable pin low disables the regulator and sends it into a “zero” off-mode-current state. In this state, current consumed by the regulator goes nearly to zero. Forcing the enable pin high enables the output voltage. The active-high enable pin uses CMOS technology and the enable pin cannot be left floating; a floating enable pin may cause an indeterminate state on the output.

Input Capacitor

The MAQ5300 is a high-performance, high bandwidth device that requires a well-bypassed input supply for optimal performance. A minimum 1 μ F X7R ceramic capacitor is required from the VIN pin to ground for stability and decoupling. The capacitor must be placed next to the VIN pin and the VIN pin to capacitor connection routed with a wide (low inductance) PCB trace. The ground terminal of the capacitor is connected directly to the GND pin with a similar low impedance trace. If a ground plane is used, the capacitor ground terminal and GND pin should be connected to the ground plane with a via. Refer to the PCB recommended layout section for a typical layout. X7R dielectric-type ceramic capacitors are used because of their -55°C to 125°C temperature range. X7R-type capacitors have a stable dielectric and change capacitance by $\pm 15\%$ over their operating temperature range. X5R dielectrics have a maximum temperature of only 85°C , while Z5U and Y5V and other lower quality dielectric capacitors must not be used as their capacitance range changes by as much as 50% to 60%. This change may cause problems with stability and regulation. Additional high-frequency capacitors, such as small-valued NPO dielectric-type capacitors, help filter out high-frequency noise.

Larger value, ceramic, tantalum and aluminum electrolytic capacitors may be used at the input, in parallel with the ceramic input capacitor described above.

Output Capacitor

The MAQ5300 requires an X7R ceramic output capacitor of 1 μ F or greater to maintain stability. The LDO is optimized for use with low-ESR ceramic chip capacitors. Higher ESR capacitors, such as aluminum electrolytic and tantalum may cause high frequency oscillation. The output capacitance can be increased, but performance has been optimized for a 1 μ F ceramic output capacitor and does not improve significantly with larger capacitance.

The capacitor must be placed next to the VOUT pin and the VOUT pin to capacitor connection routed with a wide (low inductance) PCB trace. The ground terminal of the capacitor is connected directly to the GND plane with a

similar low impedance trace. If a ground plane is used, the capacitor ground terminal and GND pin should be connected to the ground plane with a via. Refer to the PCB recommended layout section for a typical layout.

X7R dielectric-type ceramic capacitors are used because of their temperature performance. X7R-type capacitors have a stable dielectric and change capacitance by $\pm 15\%$ over their operating temperature range. As with the input capacitor, X5R capacitors may not meet the maximum ambient temperature specification and Z5U, Y5V and other lower quality dielectric capacitors must not be used to prevent stability and regulation problems. Additional high-frequency capacitors, such as small-valued NPO dielectric-type capacitors, help filter out high-frequency noise.

No-Load Stability

The MAQ5300 is stable when operating at no load.

Dropout Voltage

An LDO's dropout voltage is the minimum operating voltage difference between V_{IN} and V_{OUT} at a given output current. Once the dropout voltage is reached, lowering the input voltage will cause the output voltage to decrease and the LDO will cease to operate properly. The typical and worst case dropout voltages are listed in the electrical characteristic table.

Thermal Considerations

The MAQ5300 is designed to provide 300mA of continuous current. Maximum ambient operating temperature can be calculated based on the output current and the voltage drop across the part. For example, given that the input voltage is 3.6V, the output voltage is 2.8V and the output current equals 300mA.

The actual power dissipation of the regulator circuit can be determined using the equation:

$$P_D = (V_{\text{IN}} - V_{\text{OUT}}) I_{\text{OUT}} + V_{\text{IN}} I_{\text{GND}}$$

Because this device is CMOS and the ground current is typically $<100\mu\text{A}$ over the load range, the power dissipation contributed by the ground current is $< 1\%$ and can be ignored for this calculation.

$$PD = (3.6V - 2.8V) \times 300\text{mA}$$

$$PD = 0.24\text{W}$$

To determine the maximum ambient operating temperature of the package, use the junction-to-ambient thermal resistance of the device and the following basic equation:

$$P_{D(\text{MAX})} = \left(\frac{T_{J(\text{MAX})} - T_A}{\theta_{JA}} \right)$$

$T_{J(max)} = 125^{\circ}\text{C}$, the maximum junction temperature of the die, and θ_{JA} is the thermal resistance = 90°C/W .

Substituting P_D for $P_{D(max)}$ and solving for the ambient operating temperature will give the maximum operating conditions for the regulator circuit. The junction-to-ambient thermal resistance is 90°C/W .

The maximum power dissipation must not be exceeded for proper operation.

For example, when operating the MAQ5300-2.8YML at an input voltage of 3.6V and 300mA load, the maximum ambient operating temperature T_A can be determined as follows:

$$0.24\text{W} = (125^{\circ}\text{C} - T_A)/(90^{\circ}\text{C/W})$$

$$T_A = 103^{\circ}\text{C}$$

Therefore, a 2.8V application with 300mA of output current can accept an ambient operating temperature of 103°C .

A via can be placed under the package to maximize thermal performance. Refer to the [PCB Layout Recommendations](#) section for a typical layout.

For a full discussion of heat sinking and thermal effects on voltage regulators, refer to the "Regulator Thermals" section of *Micrel's Designing with Low-Dropout Voltage Regulators* handbook. This information can be found on Micrel's website at:

http://www.micrel.com/_PDF/other/LDOBk_ds.pdf

Typical Application Schematic

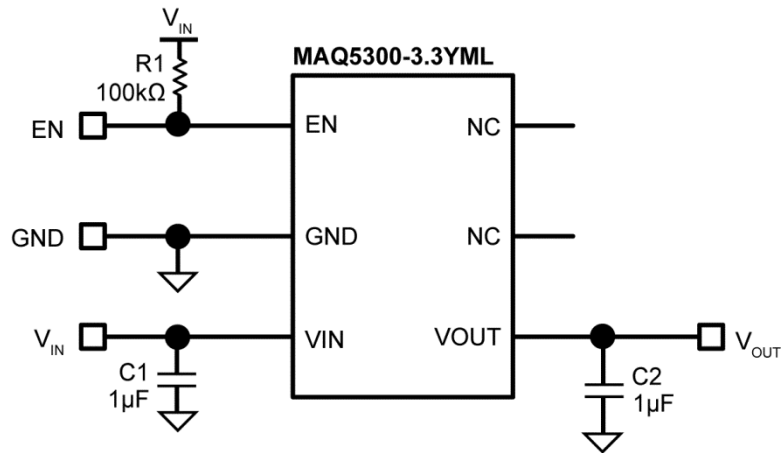

Bill of Materials

Item	Part Number	Manufacturer	Description	Qty.
R1	CRCW0603100KFKEA	Vishay Dale ⁽¹⁰⁾	100kΩ, 1%, 0603 resistor	1
C1, C2	06036C105MAT2A	AVX ⁽¹¹⁾	1uF, 6.3V, X7R, 0603, Ceramic Capacitor	2
U1	MAQ5300-3.3YML	Micrel ⁽¹²⁾	Automotive Qualified Single Output 300mA μCap LDO, 3.3V Fixed Output	1

Notes:

10. Vishay: www.vishay.com

11. AVX: www.avx.com

12. Micrel, Inc.: www.micrel.com

PCB Layout Recommendations

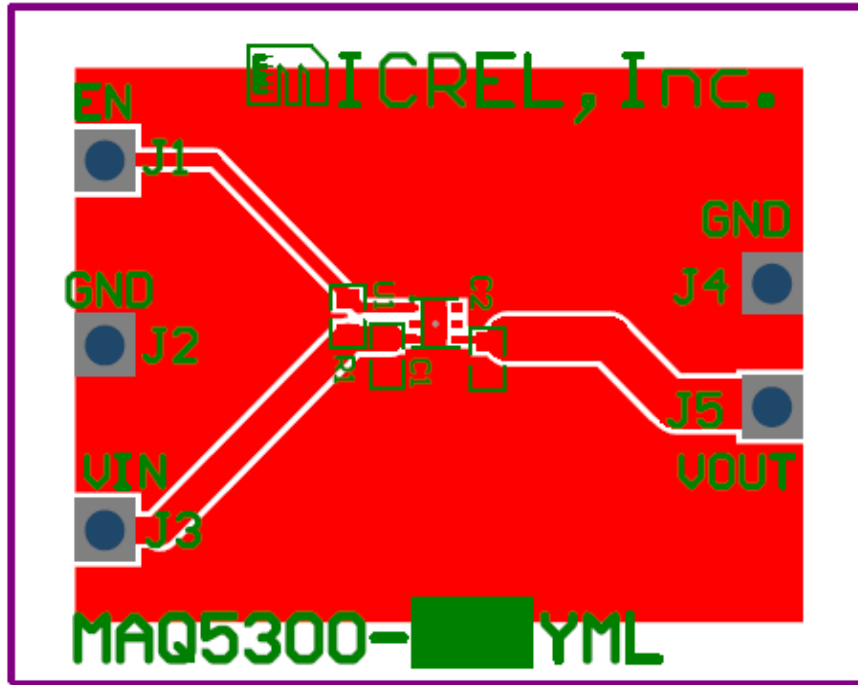

Top Layer

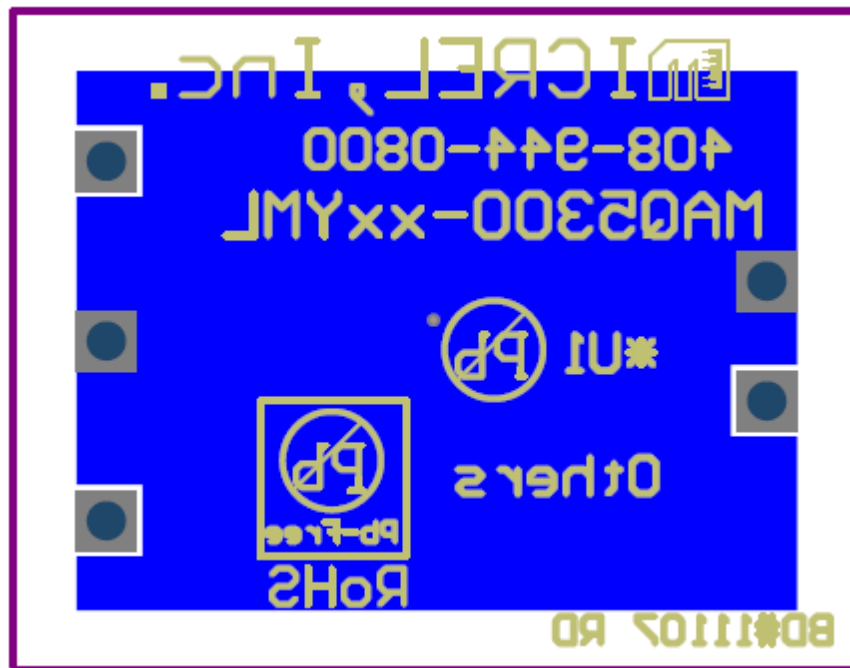

Bottom Layer

Package Information⁽¹³⁾

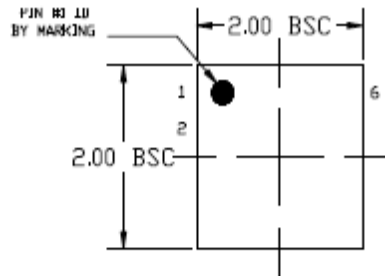

TOP VIEW
NOTE: 1, 2, 3

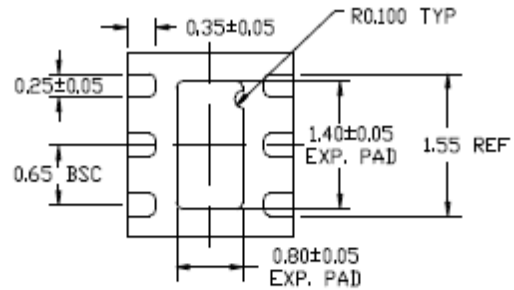

BOTTOM VIEW
NOTE: 1, 2, 3

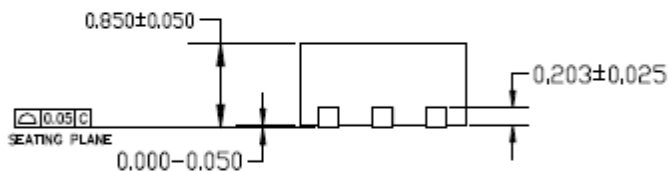

END VIEW
NOTE: 1, 2, 3

NOTE:

1. MAX PACKAGE WARPAGE IS 0.05 MM
2. MAX ALLOWABLE BURR IS 0.076MM IN ALL DIRECTIONS
3. PIN #1 IS ON TOP WILL BE LASER MARKED
4. RED CIRCLE IN LAND PATTERN INDICATE THERMAL VIA. SIZE SHOULD BE 0.30-0.3M IN DIAMETER AND SHOULD BE CONNECTED TO GND FOR MAX THERMAL PERFORMANCE
5. GREEN RECTANGLES (SHADED AREA) INDICATE SOLDER STENCIL OPENING ON EXPOSED PAD AREA. SIZE SHOULD BE 0.60x0.40 MM IN SIZE, 0.20 MM SPACING.

6-Pin 2mm x 2mm DFN (ML)

Note:

13. Package information is correct as of the publication date. For updates and most current information, go to www.micrel.com.

Recommended Landing Pattern⁽¹³⁾

RECOMMENDED LAND PATTERN

NOTE: 4,5

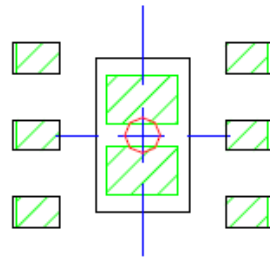

STACKED-UP

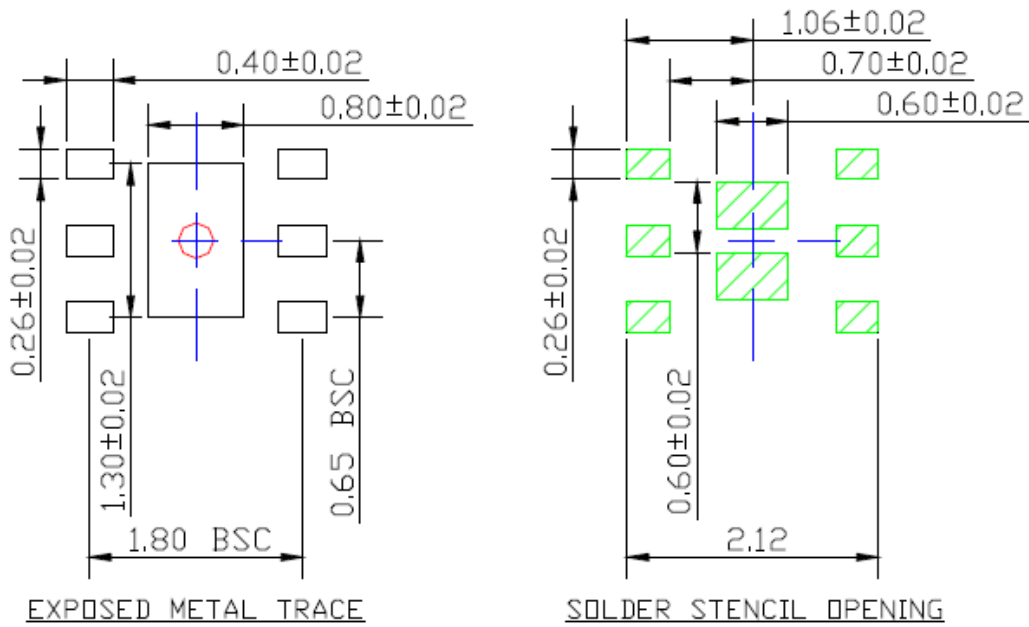

6-Pin 2mm x 2mm DFN (ML)

MICREL, INC. 2180 FORTUNE DRIVE SAN JOSE, CA 95131 USATEL +1 (408) 944-0800 FAX +1 (408) 474-1000 WEB <http://www.micrel.com>

Micrel, Inc. is a leading global manufacturer of IC solutions for the worldwide high performance linear and power, LAN, and timing & communications markets. The Company's products include advanced mixed-signal, analog & power semiconductors; high-performance communication, clock management, MEMS-based clock oscillators & crystal-less clock generators, Ethernet switches, and physical layer transceiver ICs. Company customers include leading manufacturers of enterprise, consumer, industrial, mobile, telecommunications, automotive, and computer products. Corporation headquarters and state-of-the-art wafer fabrication facilities are located in San Jose, CA, with regional sales and support offices and advanced technology design centers situated throughout the Americas, Europe, and Asia. Additionally, the Company maintains an extensive network of distributors and reps worldwide.

Micrel makes no representations or warranties with respect to the accuracy or completeness of the information furnished in this datasheet. This information is not intended as a warranty and Micrel does not assume responsibility for its use. Micrel reserves the right to change circuitry, specifications and descriptions at any time without notice. No license, whether express, implied, arising by estoppel or otherwise, to any intellectual property rights is granted by this document. Except as provided in Micrel's terms and conditions of sale for such products, Micrel assumes no liability whatsoever, and Micrel disclaims any express or implied warranty relating to the sale and/or use of Micrel products including liability or warranties relating to fitness for a particular purpose, merchantability, or infringement of any patent, copyright, or other intellectual property right.

Micrel Products are not designed or authorized for use as components in life support appliances, devices or systems where malfunction of a product can reasonably be expected to result in personal injury. Life support devices or systems are devices or systems that (a) are intended for surgical implant into the body or (b) support or sustain life, and whose failure to perform can be reasonably expected to result in a significant injury to the user. A Purchaser's use or sale of Micrel Products for use in life support appliances, devices or systems is a Purchaser's own risk and Purchaser agrees to fully indemnify Micrel for any damages resulting from such use or sale.

© 2014 Micrel, Incorporated.

Mouser Electronics

Authorized Distributor

Click to View Pricing, Inventory, Delivery & Lifecycle Information:

[Micrel:](#)

[MAQ5300-3.0YML TR](#)

[Microchip:](#)

[MAQ5300-3.0YML-TR](#)