



MIC28303

50V 3A Power Module

Hyper Speed Control™ Family

General Description

Micrel's MIC28303 is synchronous step-down regulator module, featuring a unique adaptive ON-time control architecture. The module incorporates a DC/DC controller, power MOSFETs, bootstrap diode, bootstrap capacitor and an inductor in a single package. The MIC28303 operates over an input supply range from 4.5V to 50V and can be used to supply up to 3A of output current. The output voltage is adjustable down to 0.8V with a guaranteed accuracy of $\pm 1\%$. The device operates with programmable switching frequency from 200kHz to 600kHz.

The MIC28303-1 uses Micrel's HyperLight Load® architecture for improved efficiency at light loads. The MIC28303-2 uses Micrel's Hyper Speed Control™ for ultra-fast transient response.

The MIC28303 offers a full suite of protection features. These include undervoltage lockout, internal soft-start, foldback current limit, "hiccup" mode short-circuit protection, and thermal shutdown.

Datasheets and support documentation are available on Micrel's website at: www.micrel.com.

Features

- Easy to use
 - Stable with low-ESR ceramic output capacitor
 - No compensation and no inductor to choose
- 4.5V to 50V input voltage
- Single-supply operation
- Power Good (PG) output
- Low radiated emission (EMI) per EN55022, Class B
- Adjustable current limit
- Adjustable output voltage from 0.9V to 24V (also limited by duty cycle)
- 200kHz to 600kHz, programmable switching frequency
- Supports safe start-up into a pre-biased output
- -40°C to $+125^{\circ}\text{C}$ junction temperature range
- Available in 64-pin, 12mm x 12mm x 3mm QFN package

Applications

- Distributed power systems
- Industrial, medical, telecom, and automotive

Typical Application

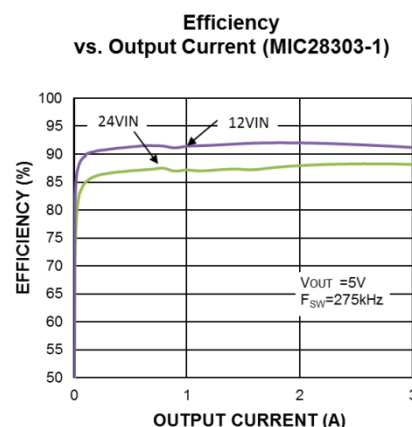
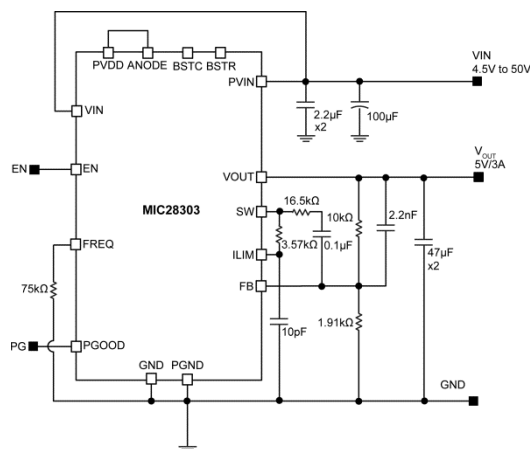

Hyper Speed Control and Any Capacitor are trademarks of Micrel, Inc.

HyperLight Load is a registered trademark of Micrel, Inc.

Micrel Inc. • 2180 Fortune Drive • San Jose, CA 95131 • USA • tel +1 (408) 944-0800 • fax + 1 (408) 474-1000 • <http://www.micrel.com>

Ordering Information

| Part Number | Switching Frequency | Features | Package | Junction Temperature Range | Lead Finish |
|---------------|---------------------|---------------------|------------------------|----------------------------|-------------|
| MIC28303-1YMP | 200kHz to 600kHz | HyperLight Load | 64-pin 12mm × 12mm QFN | −40°C to +125°C | Pb-Free |
| MIC28303-2YMP | 200kHz to 600kHz | Hyper Speed Control | 64-pin 12mm × 12mm QFN | −40°C to +125°C | Pb-Free |

Pin Configuration

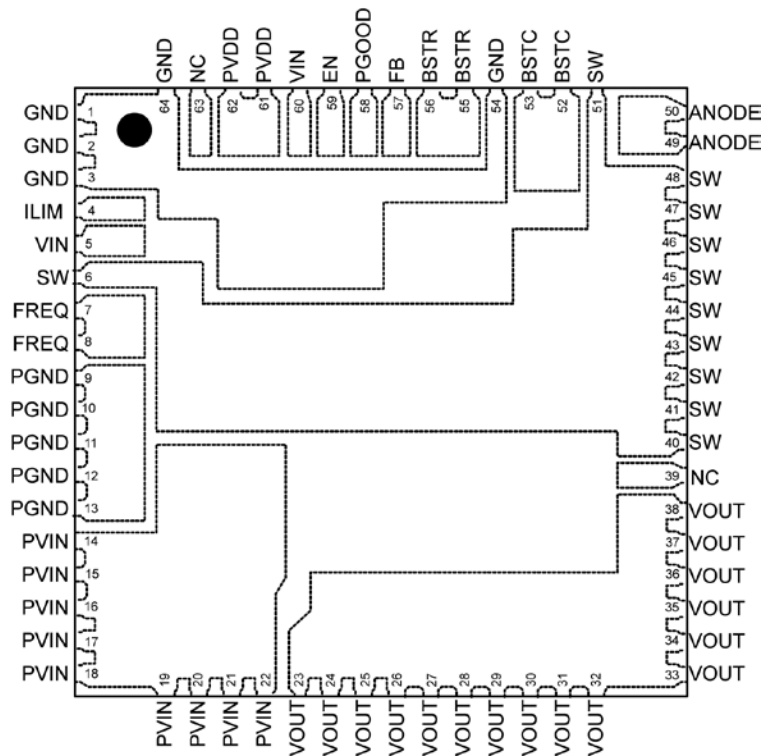

**64-Pin 12mm × 12mm QFN (MP)
(Top View)**

Pin Description

| Pin Number | Pin Name | Pin Function |
|-----------------|----------|---|
| 1, 2, 3, 54, 64 | GND | Analog Ground. Ground for internal controller and feedback resistor network. The analog ground return path should be separate from the power ground (PGND) return path. |
| 4 | ILIM | Current Limit Setting. Connect a resistor from SW (pin 6) to ILIM to set the over-current threshold for the converter. |
| 5, 60 | VIN | Supply Voltage for Controller. The VIN operating voltage range is from 4.5V to 50V. A 0.47μF ceramic capacitor from VIN (pin 60) to GND is required for decoupling. Pin 5 should be externally connected to either PVIN or pin 60 on PCB. |
| 6, 40 to 48, 51 | SW | Switch Node and Current-Sense Input. High current output driver return. The SW pin connects directly to the switch node. Due to the high-speed switching on this pin, the SW pin should be routed away from sensitive nodes. The SW pin also senses the current by monitoring the voltage across the low-side MOSFET during OFF time. |

Pin Description (Continued)

| Pin Number | Pin Name | Pin Function |
|------------|----------|---|
| 7, 8 | FREQ | Switching Frequency Adjust Input. Leaving this pin open will set the switching frequency to 600kHz. Alternatively, a resistor from this pin to ground can be used to lower the switching frequency. |
| 9 to 13 | PGND | Power Ground. PGND is the return path for the buck converter power stage. The PGND pin connects to the sources of low-side N-Channel external MOSFET, the negative terminals of input capacitors, and the negative terminals of output capacitors. The return path for the power ground should be as small as possible and separate from the analog ground (GND) return path. |
| 14 to 22 | PVIN | Power Input Voltage. Connection to the drain of the internal high-side power MOSFET. |
| 23 to 38 | VOUT | Output Voltage. Connection with the internal inductor, the output capacitor should be connected from this pin to PGND as close to the module as possible. |
| 39 | NC | No Connection. Leave it floating. |
| 49, 50 | ANODE | Anode Bootstrap Diode Input. Anode connection of internal bootstrap diode. This pin should be connected to the PVDD pin. |
| 52, 53 | BSTC | Bootstrap Capacitor. Connection to the internal bootstrap capacitor. Leave floating, no connect. |
| 55, 56 | BSTR | Bootstrap Resistor. Connection to the internal bootstrap resistor and high-side power MOSFET drive circuitry. Leave floating, no connect. |
| 57 | FB | Feedback Input. Input to the transconductance amplifier of the control loop. The FB pin is regulated to 0.8V. A resistor divider connecting the feedback to the output is used to set the desired output voltage. |
| 58 | PGOOD | Power Good Output. Open-drain output. An external pull-up resistor to external power rails is required. |
| 59 | EN | Enable Input. A logic signal to enable or disable the buck converter operation. The EN pin is CMOS compatible. Logic high enables the device, logic low shuts down the regulator. In the disable mode, the input supply current for the device is minimized to 4 μ A typically. Do not pull EN to PVDD. |
| 61, 62 | PVDD | Internal +5V Linear Regulator Output. PVDD is the internal supply bus for the device. In the applications with VIN < +5.5V, PVDD should be tied to VIN to by-pass the linear regulator. |
| 63 | NC | No Connection. Leave it floating. |

Absolute Maximum Ratings⁽¹⁾

| | |
|---|------------------------|
| PVIN, VIN to PGND | -0.3V to +56V |
| PVDD, V _{ANODE} to PGND | -0.3V to +6V |
| V _{SW} , V _{FREQ} , V _{ILIM} , V _{EN} | -0.3V to (PVIN +0.3V) |
| V _{BSTC/BSTR} to V _{SW} | -0.3V to 6V |
| V _{BSTC/BSTR} to PGND..... | -0.3V to 56V |
| V _{FB} , V _{PG} to PGND | -0.3V to (PVDD + 0.3V) |
| PGND to AGND..... | -0.3V to +0.3V |
| Junction Temperature | +150°C |
| Storage Temperature (T _S)..... | -65°C to +150°C |
| Lead Temperature (soldering, 10s)..... | 260°C |
| ESD Rating ⁽³⁾ | ESD Sensitive |

Operating Ratings⁽²⁾

| | |
|---|-----------------|
| Supply Voltage (PVIN, VIN) | 4.5V to 50V |
| Enable Input (V _{EN}) | 0V to VIN |
| V _{SW} , V _{FREQ} , V _{ILIM} , V _{EN} | 0V to VIN |
| Power Good (V _{PGOOD})..... | 0V to PVDD |
| Junction Temperature (T _J) | -40°C to +125°C |
| Junction Thermal Resistance | |
| 12mm x 12mm QFN-64 (θ _{JA}) | 20°C/W |
| 12mm x 12mm QFN-64 (θ _{JC})..... | 5°C/W |

Electrical Characteristics⁽⁴⁾

PVIN = VIN = 12V, V_{OUT} = 5V, V_{BST} - V_{SW} = 5V; T_A = 25°C, unless noted. **Bold** values indicate -40°C ≤ T_J ≤ +125°C.

| Parameter | Condition | Min. | Typ. | Max. | Units |
|--|--|--------------|------------|--------------|-------|
| Power Supply Input | | | | | |
| Input Voltage Range (PVIN, VIN) | | 4.5 | | 50 | V |
| Controller Supply Current ⁽⁵⁾ | Current into Pin 60; V _{FB} = 1.5V (MIC28303-1) | | 0.4 | 0.75 | mA |
| | Current into Pin 60; V _{FB} = 1.5V (MIC28303-2) | | 2.1 | 3 | |
| | Current into Pin 60; V _{EN} = 0V | | 0.1 | 10 | μA |
| Operating Current | I _{OUT} = 0A (MIC28303-1) | | 0.7 | | mA |
| | I _{OUT} = 0A (MIC28303-2) | | 27 | | |
| Shutdown Supply Current | PVIN = VIN = 12V, V _{EN} = 0V | | 4 | | μA |
| PVDD Supply⁽⁵⁾ | | | | | |
| PVDD Output Voltage | VIN = 7V to 50V, I _{PVDD} = 10mA | 4.8 | 5.2 | 5.4 | V |
| PVDD UVLO Threshold | PVDD rising | 3.8 | 4.2 | 4.7 | V |
| PVDD UVLO Hysteresis | | | 400 | | mV |
| Load Regulation | I _{PVDD} = 0 to 40mA | 0.6 | 2 | 3.6 | % |
| Reference⁽⁵⁾ | | | | | |
| Feedback Reference Voltage | T _J = 25°C (±1.0%) | 0.792 | 0.8 | 0.808 | V |
| | -40°C ≤ T _J ≤ 125°C (±2%) | 0.784 | 0.8 | 0.816 | |
| FB Bias Current | V _{FB} = 0.8V | | 5 | 500 | nA |

Notes:

- Exceeding the absolute maximum ratings may damage the device.
- The device is not guaranteed to function outside its operating ratings.
- Devices are ESD sensitive. Handling precautions are recommended. Human body model, 1.5kΩ in series with 100pF.
- Specification for packaged product only.
- IC tested prior to assembly.

Electrical Characteristics⁽⁴⁾ (Continued)

PVIN = VIN = 12V, V_{OUT} = 5V, V_{BST} - V_{SW} = 5V; T_A = 25°C, unless noted. **Bold** values indicate -40°C ≤ T_J ≤ +125°C.

| Parameter | Condition | Min. | Typ. | Max. | Units |
|---|--|------------|------|------------|-------------------|
| Enable Control | | | | | |
| EN Logic Level High | | 1.8 | | | V |
| EN Logic Level Low | | | | 0.6 | V |
| EN Hysteresis | | | 200 | | mV |
| EN Bias Current | V _{EN} = 12V | | 5 | 20 | μA |
| Oscillator | | | | | |
| Switching Frequency | FREQ pin = open | 400 | 600 | 750 | kHz |
| | RFREQ = 100kΩ (FREQ pin-to-GND) | | 300 | | |
| Maximum Duty Cycle | | | 85 | | % |
| Minimum Duty Cycle | V _{FB} > 0.8V | | 0 | | % |
| Minimum Off-Time | | 140 | 200 | 260 | ns |
| Soft-Start⁽⁵⁾ | | | | | |
| Soft-Start Time | | | 5 | | ms |
| Short-Circuit Protection⁽⁵⁾ | | | | | |
| Current-Limit Threshold (V _{CL}) | V _{FB} = 0.79V | -30 | -14 | 0 | mV |
| Short-Circuit Threshold | V _{FB} = 0V | -23 | -7 | 9 | mV |
| Current-Limit Source Current | V _{FB} = 0.79V | 60 | 80 | 100 | μA |
| Short-Circuit Source Current | V _{FB} = 0V | 27 | 36 | 47 | μA |
| Leakage | | | | | |
| SW, BSTR Leakage Current | | | | 50 | μA |
| Power Good⁽⁵⁾ | | | | | |
| Power Good Threshold Voltage | Sweep V _{FB} from low-to-high | 85 | 90 | 95 | %V _{OUT} |
| Power Good Hysteresis | Sweep V _{FB} from high-to-low | | 6 | | %V _{OUT} |
| Power Good Delay Time | Sweep V _{FB} from low-to-high | | 100 | | μs |
| Power Good Low Voltage | V _{FB} < 90% × V _{NOM} , I _{PG} = 1mA | | 70 | 200 | mV |
| Thermal Protection | | | | | |
| Overtemperature Shutdown | T _J Rising | | 160 | | °C |
| Overtemperature Shutdown Hysteresis | | | 4 | | °C |

Electrical Characteristics⁽⁴⁾ (Continued)

PVIN = VIN = 12V, V_{OUT} = 5V, V_{BST} - V_{SW} = 5V; T_A = 25°C, unless noted. **Bold** values indicate -40°C ≤ T_J ≤ +125°C.

| Parameter | Condition | Min. | Typ. | Max. | Units |
|---|---|------|------|------|-------|
| Output Characteristic | | | | | |
| Output Voltage Ripple | I _{OUT} = 3A | | 16 | | mV |
| Line Regulation | PVIN = VIN = 7V to 50V, I _{OUT} = 3A | | 0.36 | | % |
| Load Regulation | I _{OUT} = 0A to 3A PVIN= VIN =12V (MIC28303-1) | | 0.75 | | % |
| | I _{OUT} = 0A to 3A PVIN= VIN =12V (MIC28303-2) | | 0.05 | | |
| Output Voltage Deviation from Load Step | I _{OUT} from 0A to 3A at 5A/μs (MIC28303-1) | | 400 | | mV |
| | I _{OUT} from 3A to 0A at 5A/μs (MIC28303-1) | | 500 | | |
| | I _{OUT} from 0A to 3A at 5A/μs (MIC28303-2) | | 400 | | |
| | I _{OUT} from 3A to 0A at 5A/μs (MIC28303-2) | | 500 | | |

Typical Characteristics – 275kHz Switching Frequency

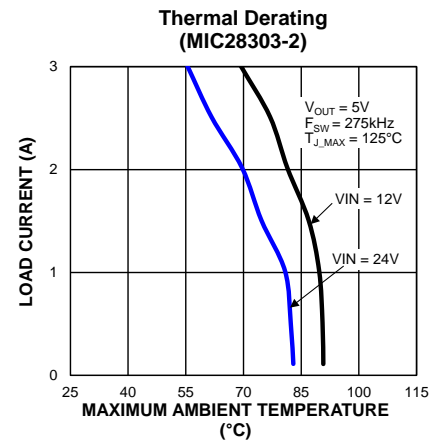
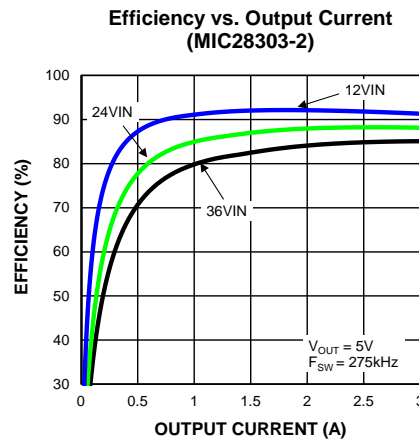
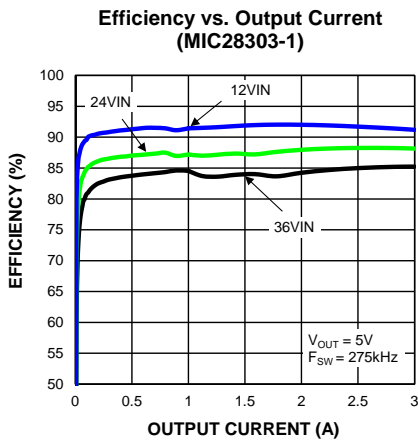
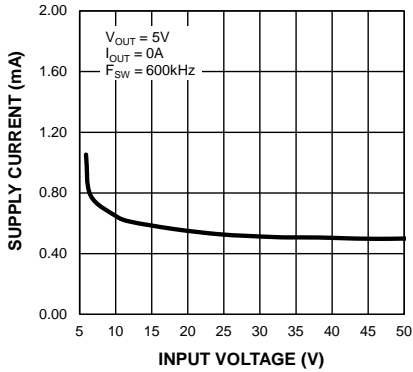

Table 1. Recommended Component Values for 275kHz Switching Frequency

| V_{OUT} | V_{IN} | R3 (R_{in}) | R19 | R15 | R1 (Top Feedback Resistor) | R11 (Bottom Feedback Resistor) | C10 (C_{in}) | C12 (C_{ff}) | C_{OUT} |
|-----------|------------|-----------------|--------------|-------|----------------------------|--------------------------------|------------------|------------------|--------------------|
| 5V | 7V to 18V | 16.5k Ω | 75k Ω | 3.57k | 10k Ω | 1.9k Ω | 0.1 μ F | 2.2nF | 2x47 μ F/6.3V |
| 5V | 18V to 50V | 39.2k Ω | 75k Ω | 3.57k | 10k Ω | 1.9k Ω | 0.1 μ F | 2.2nF | 2x 47 μ F/6.3V |
| 3.3V | 5V to 18V | 16.5k Ω | 75k Ω | 3.57k | 10k Ω | 3.24k Ω | 0.1 μ F | 2.2nF | 2x 47 μ F/6.3V |
| 3.3V | 18V to 50V | 39.2k Ω | 75k Ω | 3.57k | 10k Ω | 3.24k Ω | 0.1 μ F | 2.2nF | 2x 47 μ F/6.3V |

Typical Characteristics

VIN Operating Supply Current vs. Input Voltage (MIC28303-1)



Output Regulation vs. Input Voltage (MIC28303-1)

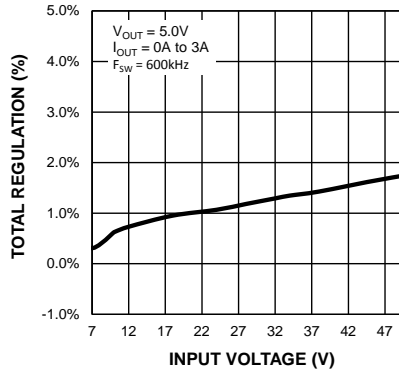

Output Voltage vs. Input Voltage (MIC28303-1)

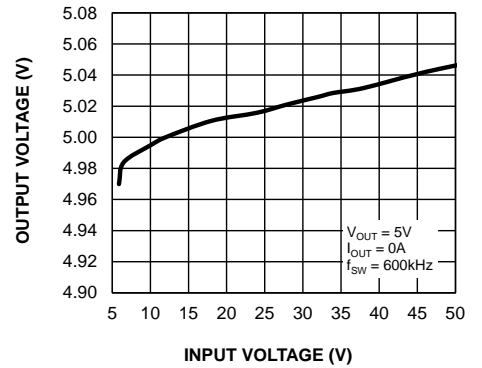

VIN Operating Supply Current vs. Temperature (MIC28303-1)

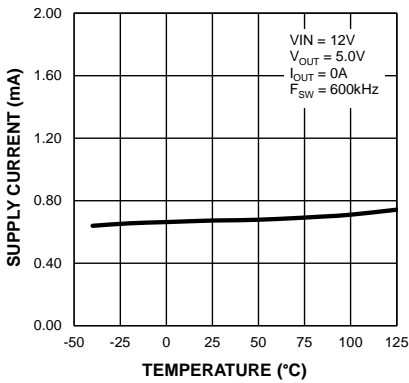

Load Regulation vs. Temperature (MIC28303-1)

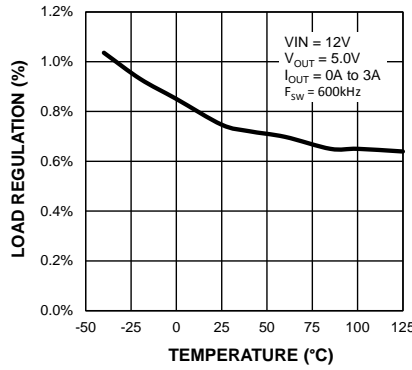

Line Regulation vs. Temperature (MIC28303-1)

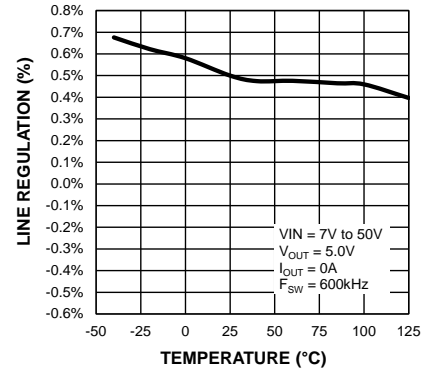

Line Regulation vs. Temperature (MIC28303-1)

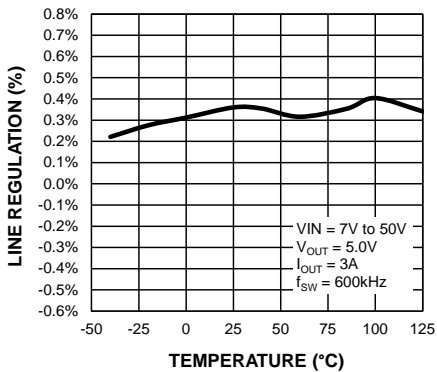

Line Regulation vs. Output Current (MIC28303-1)

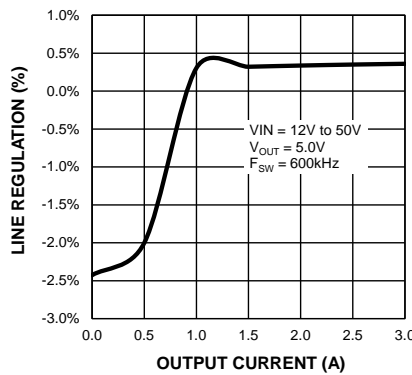

Efficiency (VIN = 12V) vs. Output Current (MIC28303-1)

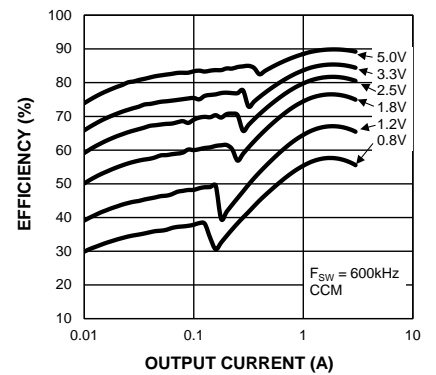

Typical Characteristics (Continued)

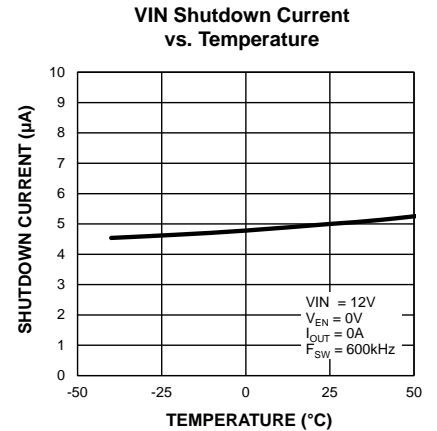
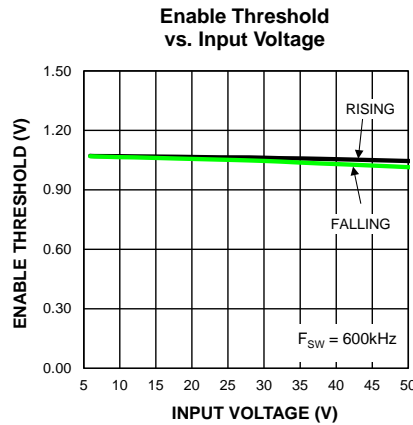
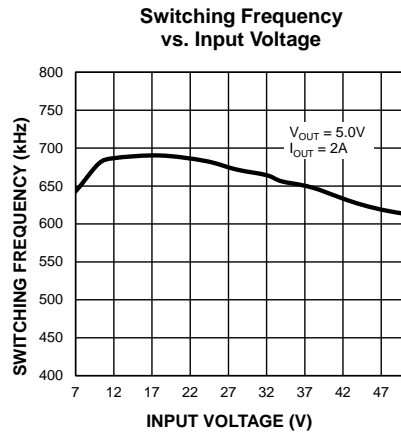
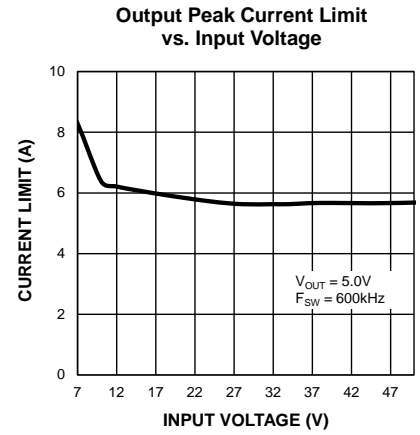
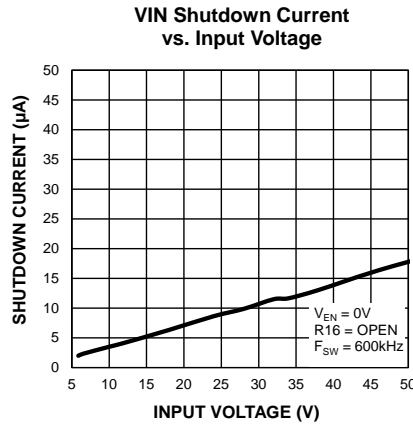
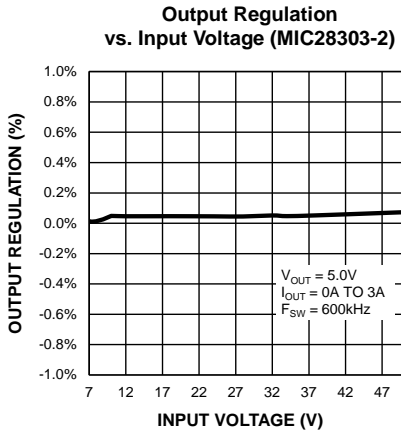
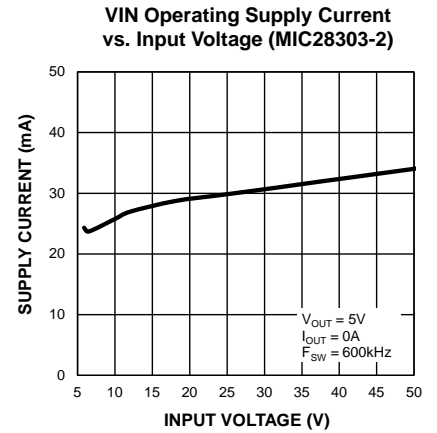
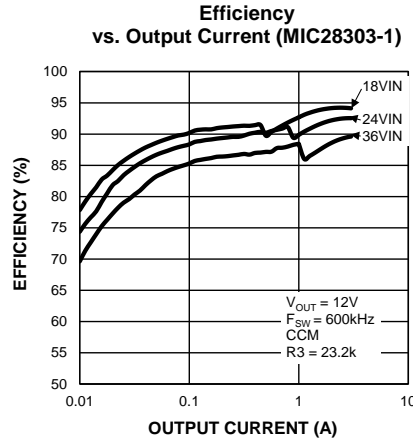
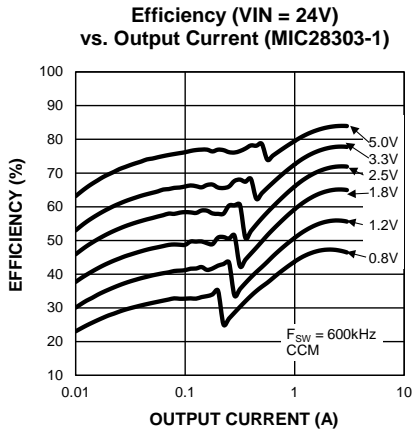

Typical Characteristics (Continued)

Output Peak Current Limit vs. Temperature

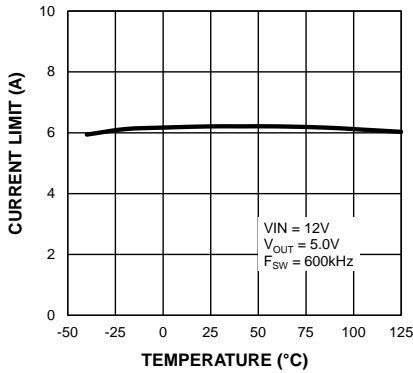

EN Bias Current vs. Temperature

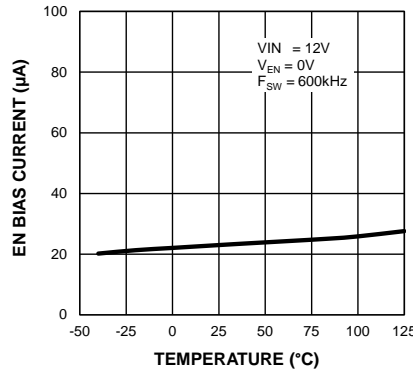

Enable Threshold vs. Temperature

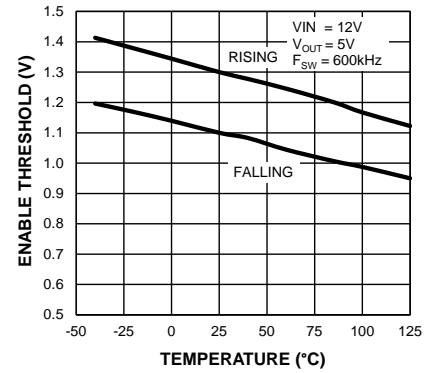

VIN Operating Supply Current vs. Temperature (MIC28303-2)

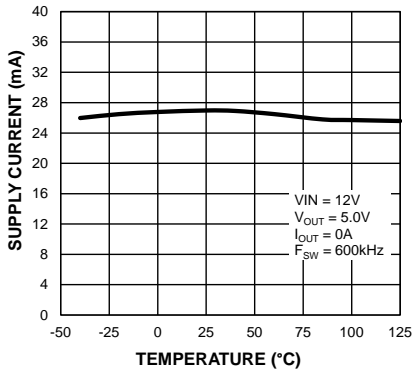

Load Regulation vs. Temperature (MIC28303-2)

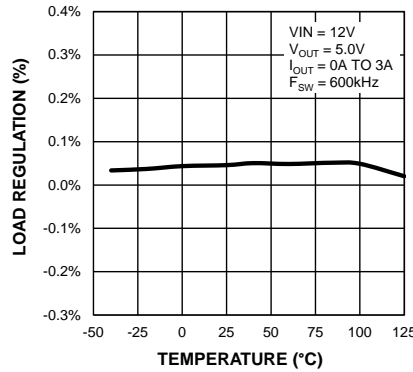

Line Regulation vs. Temperature (MIC28303-2)

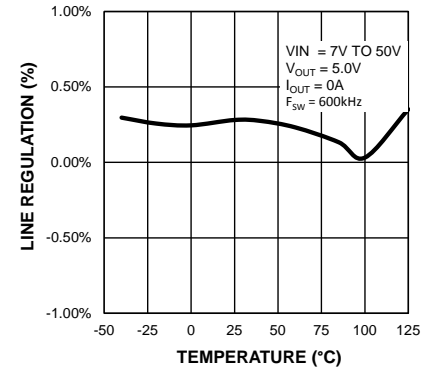

Line Regulation vs. Temperature (MIC28303-2)

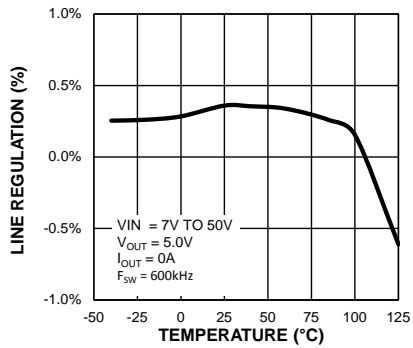

Switching Frequency vs. Temperature (MIC28303-2)

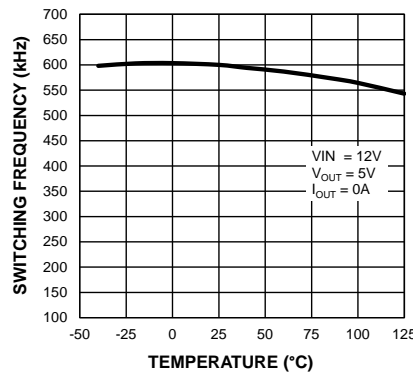

Line Regulation vs. Output Current (MIC28303-2)

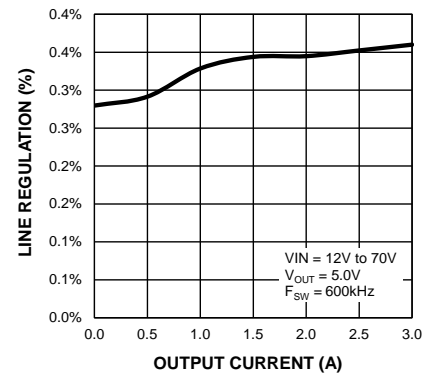

Typical Characteristics (Continued)

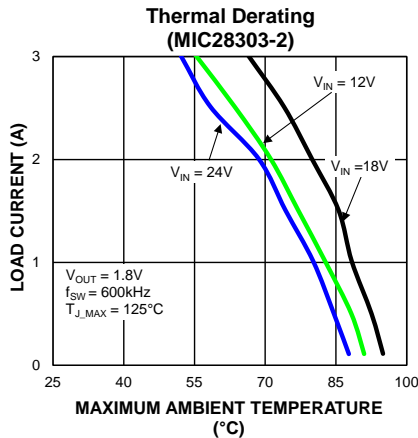
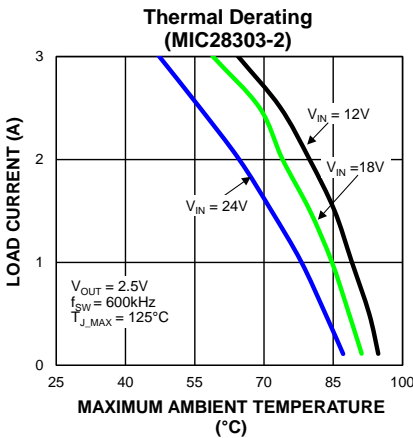
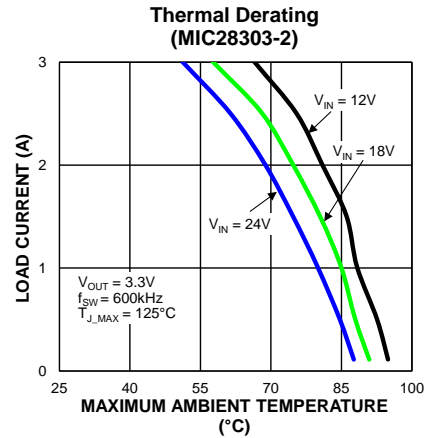
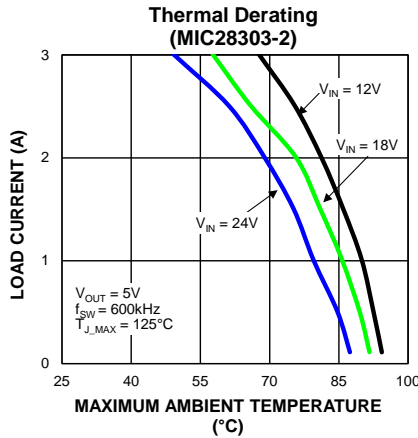
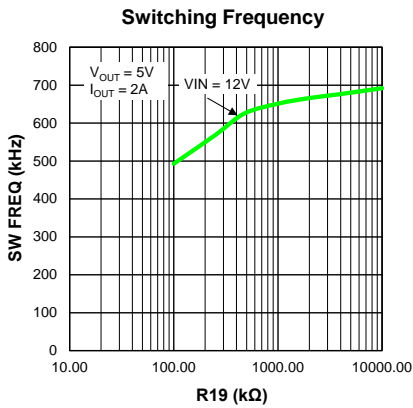
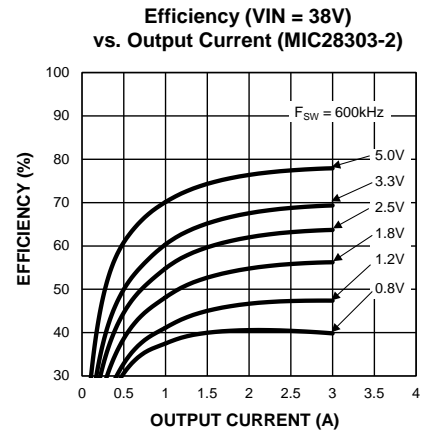
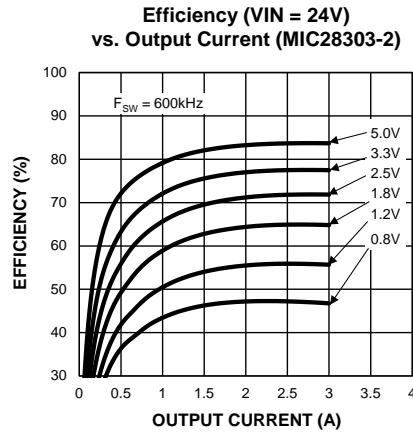
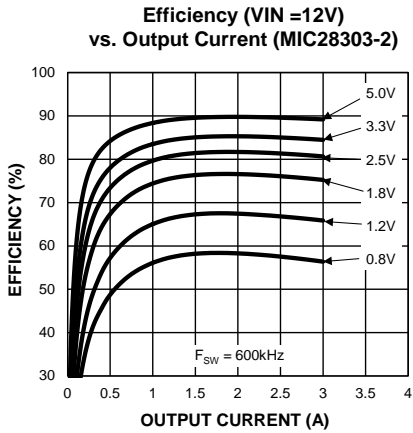

Functional Characteristics – 600kHz Switching Frequency

Enable Turn-On Delay and Rise Time

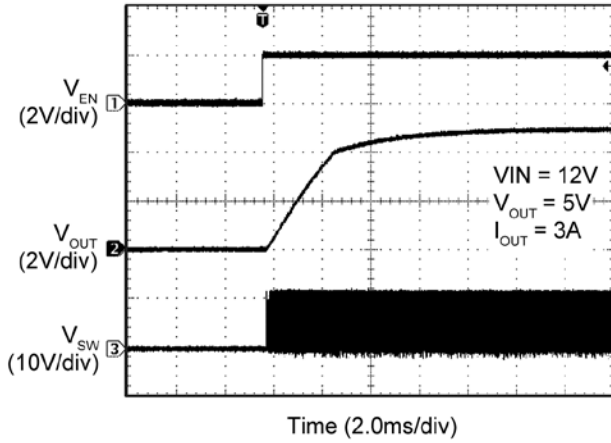

Enable Turn-Off Delay and Fall Time

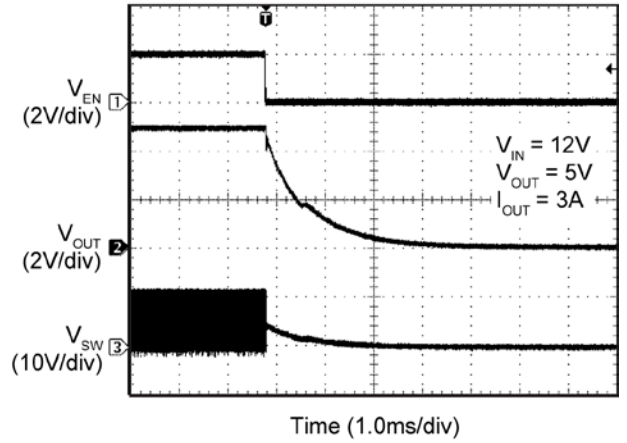

MIC28303-2 VIN Start-Up with Pre-Biased Output

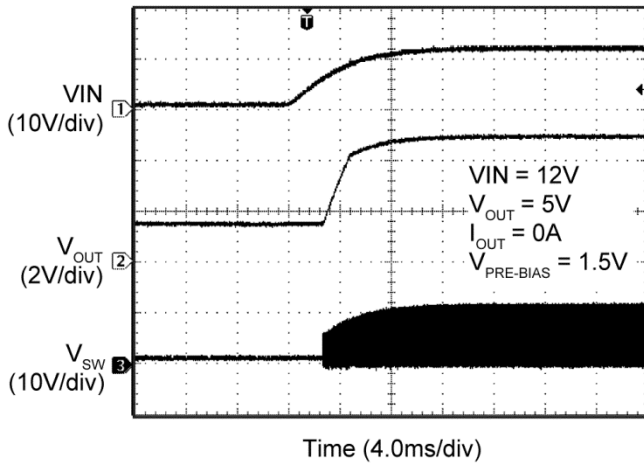

MIC28303-1 VIN Start-Up with Pre-Biased Output

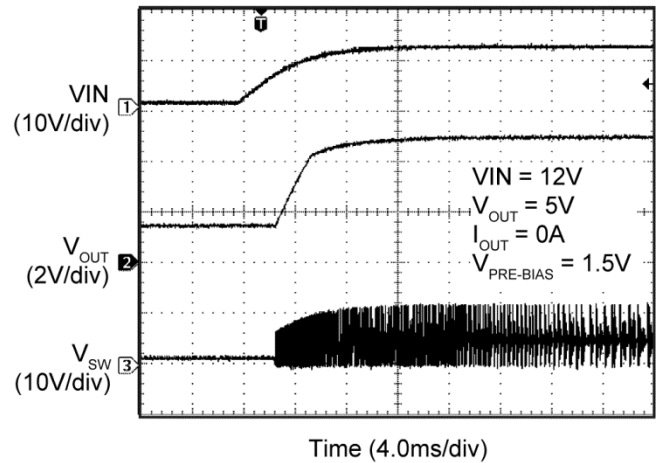

Enable Turn-On/Turn-Off

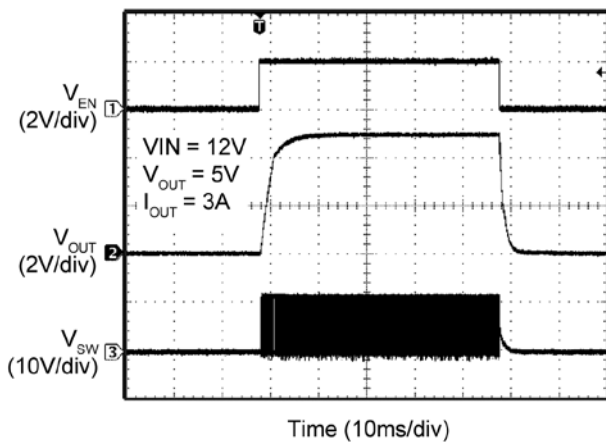

Enable Thresholds

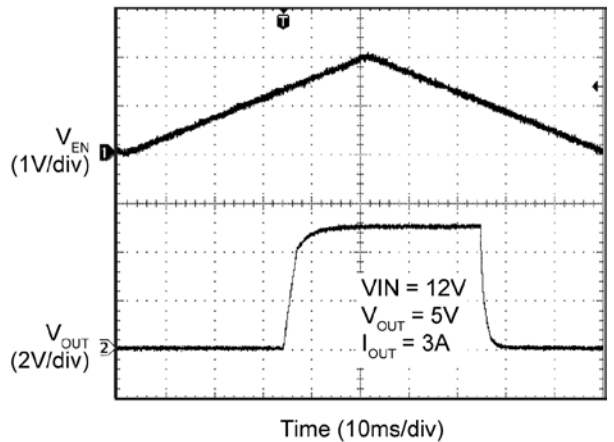

Functional Characteristics – 600kHz Switching Frequency (Continued)

VIN UVLO Thresholds

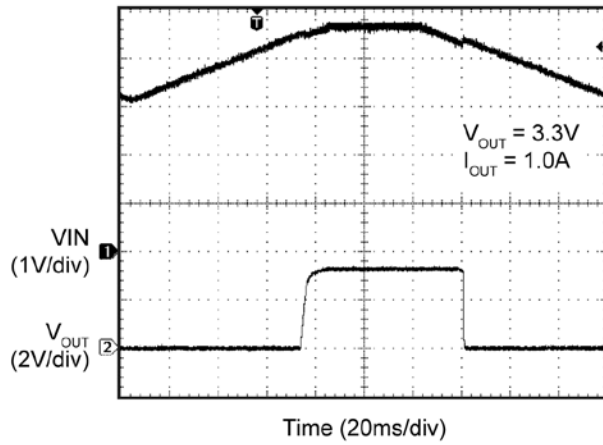

Power-Up into Short Circuit

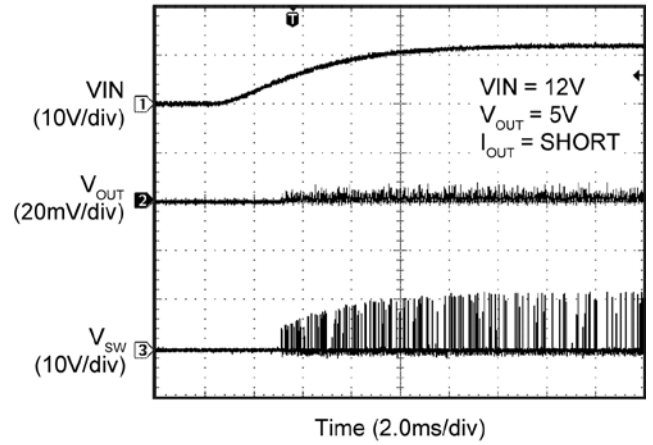

Enabled into Short

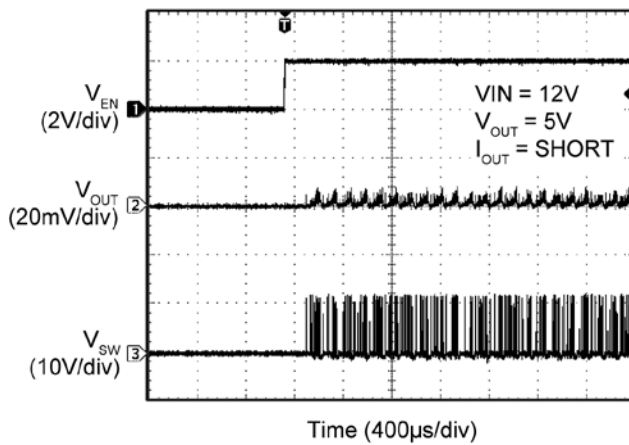

Output Peak Current-Limit Threshold

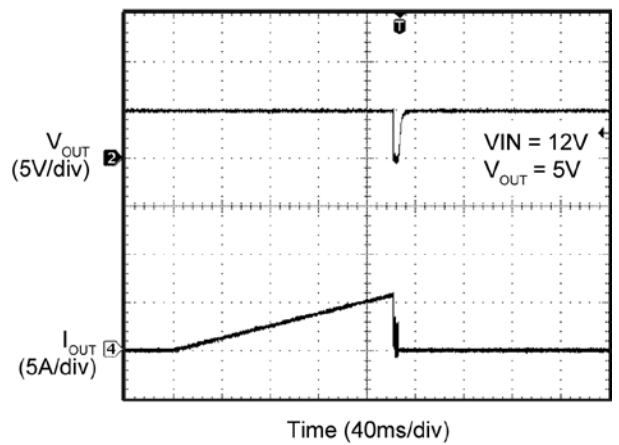

Short Circuit

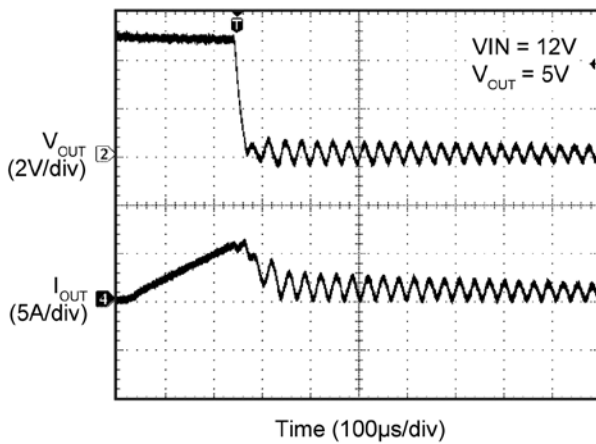

Output Recovery from Thermal Shutdown

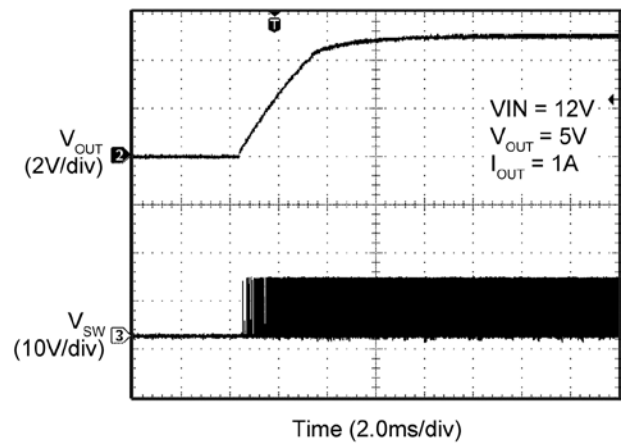

Functional Characteristics – 600kHz Switching Frequency (Continued)

MIC28303-2 Switching Waveforms
($I_{OUT} = 3A$)

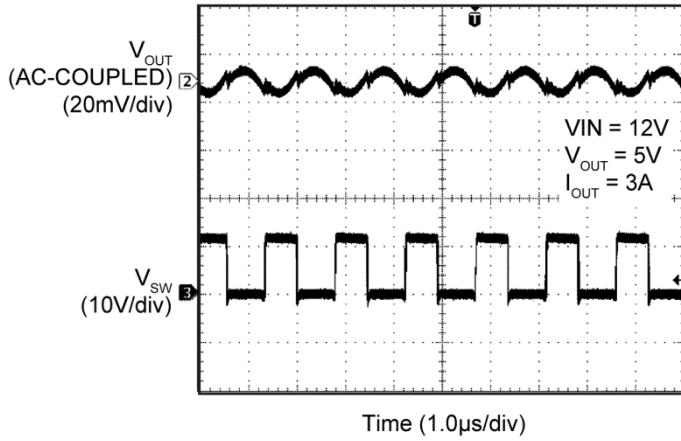

MIC28303-2 Transient Response

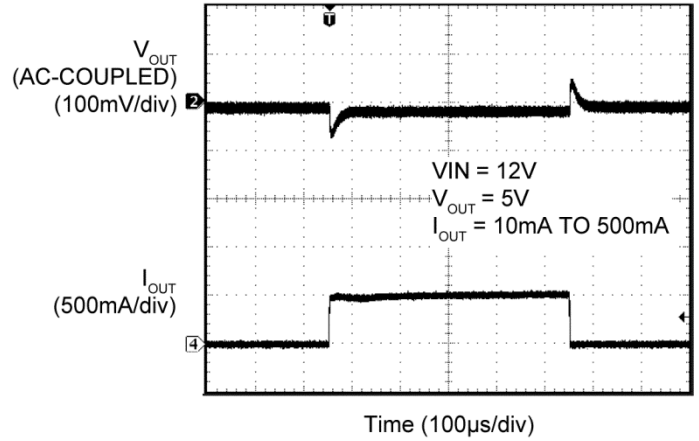

MIC28303-2 Transient Response

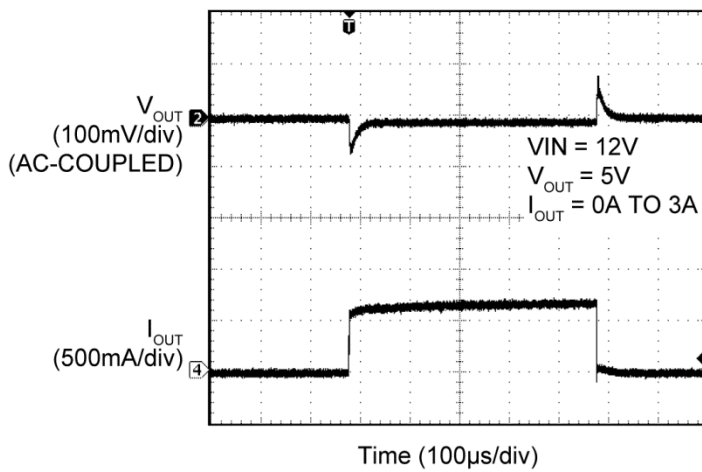

MIC28303-1 Transient Response

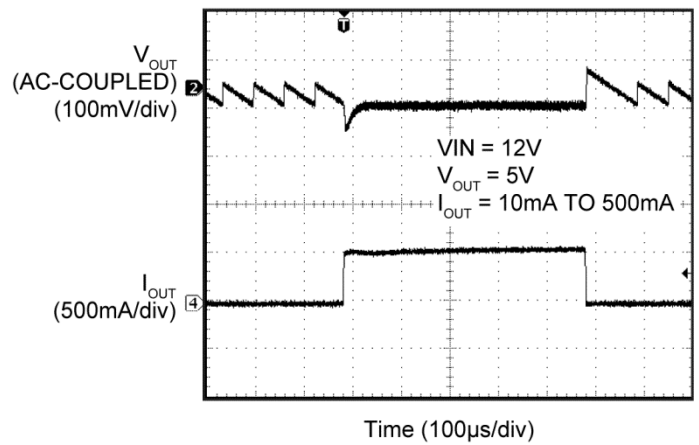

MIC28303-2 Transient Response

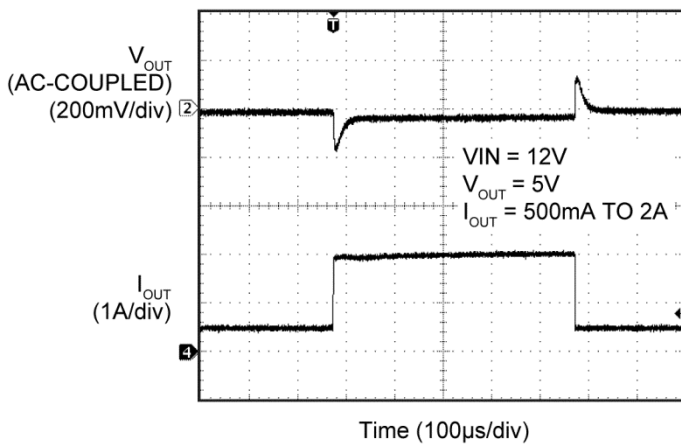

MIC28303-1 Transient Response

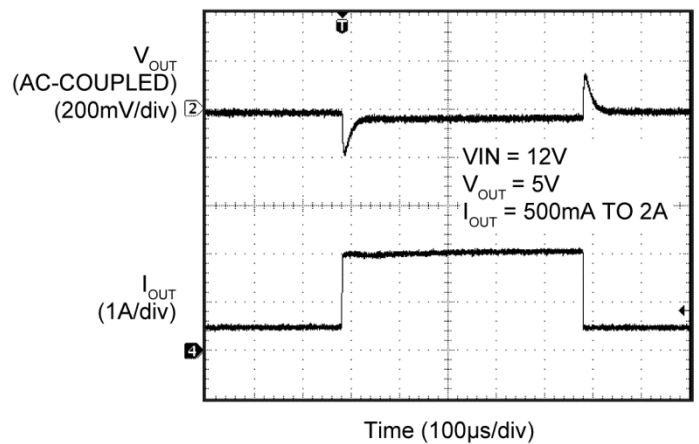

Functional Characteristics – 600kHz Switching Frequency (Continued)

MIC28303-2 Transient Response

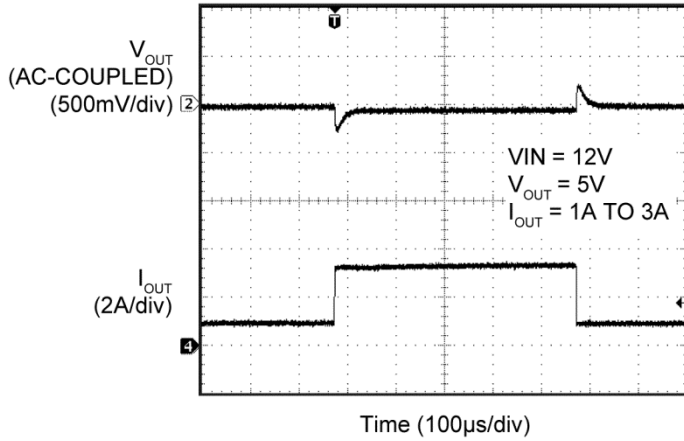

MIC28303-1 Transient Response

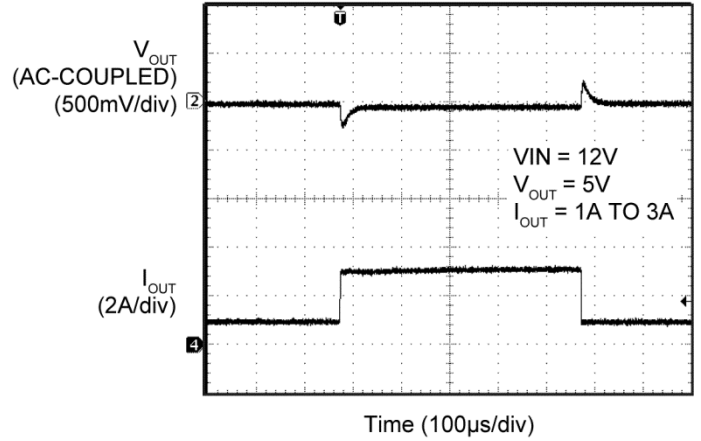

Power Good @ VIN Soft Turn-On

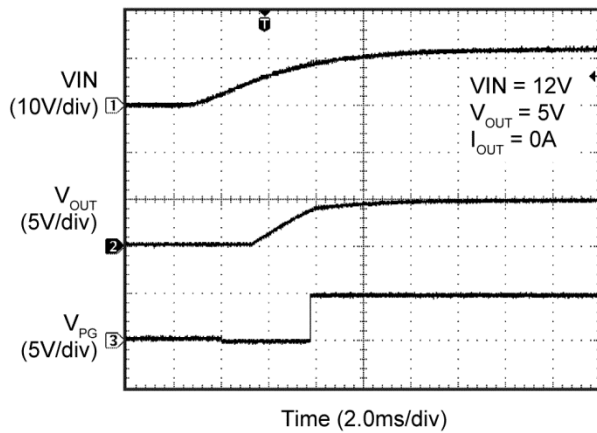

Power Good @ VIN Soft Turn-Off

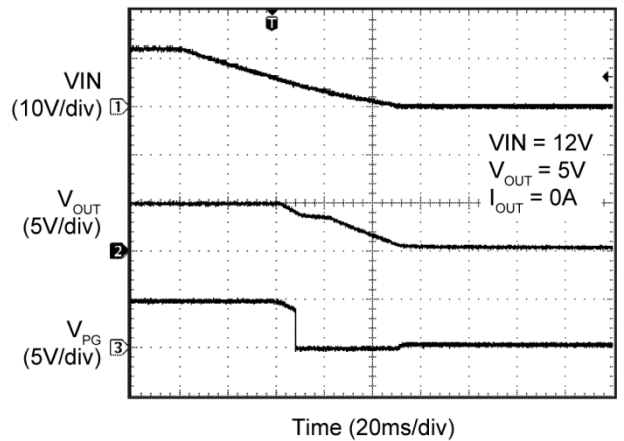

**Radiated Emission – 30MHz to 1000MHz
(VIN = 12V/I_{OUT} = 2A)**

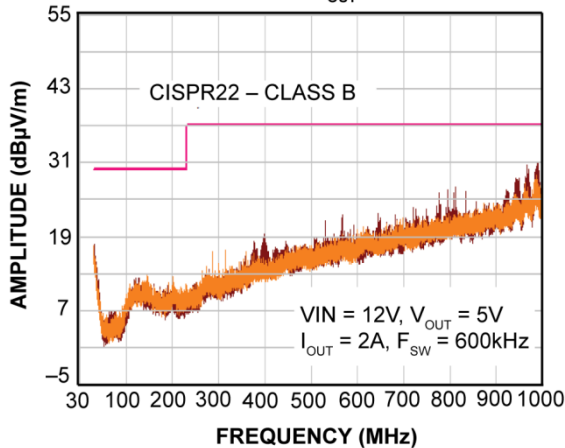

**Radiated Emission – 30MHz to 1000MHz
(VIN = 36V/I_{OUT} = 2A)**

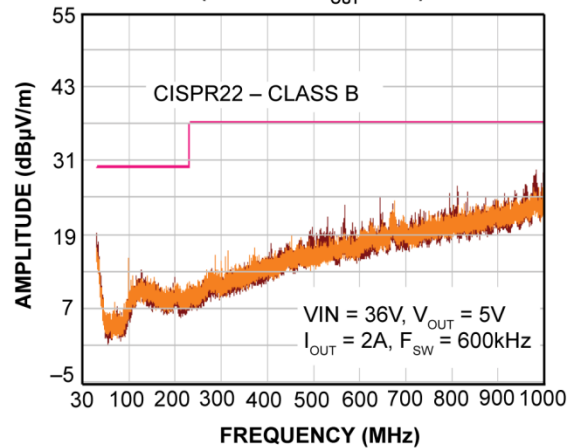

Functional Characteristics – 600kHz Switching Frequency (Continued)

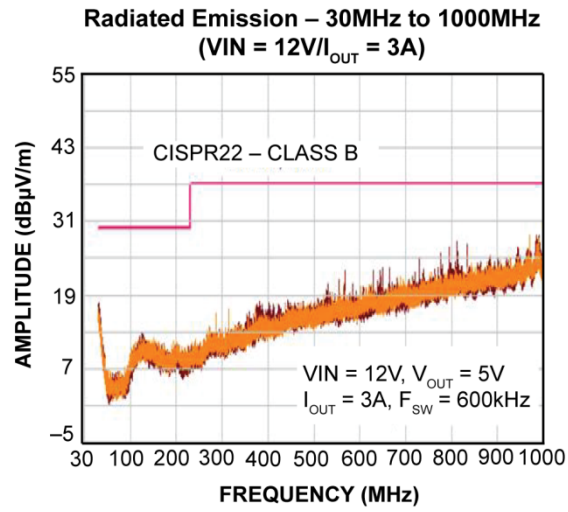

Functional Diagram

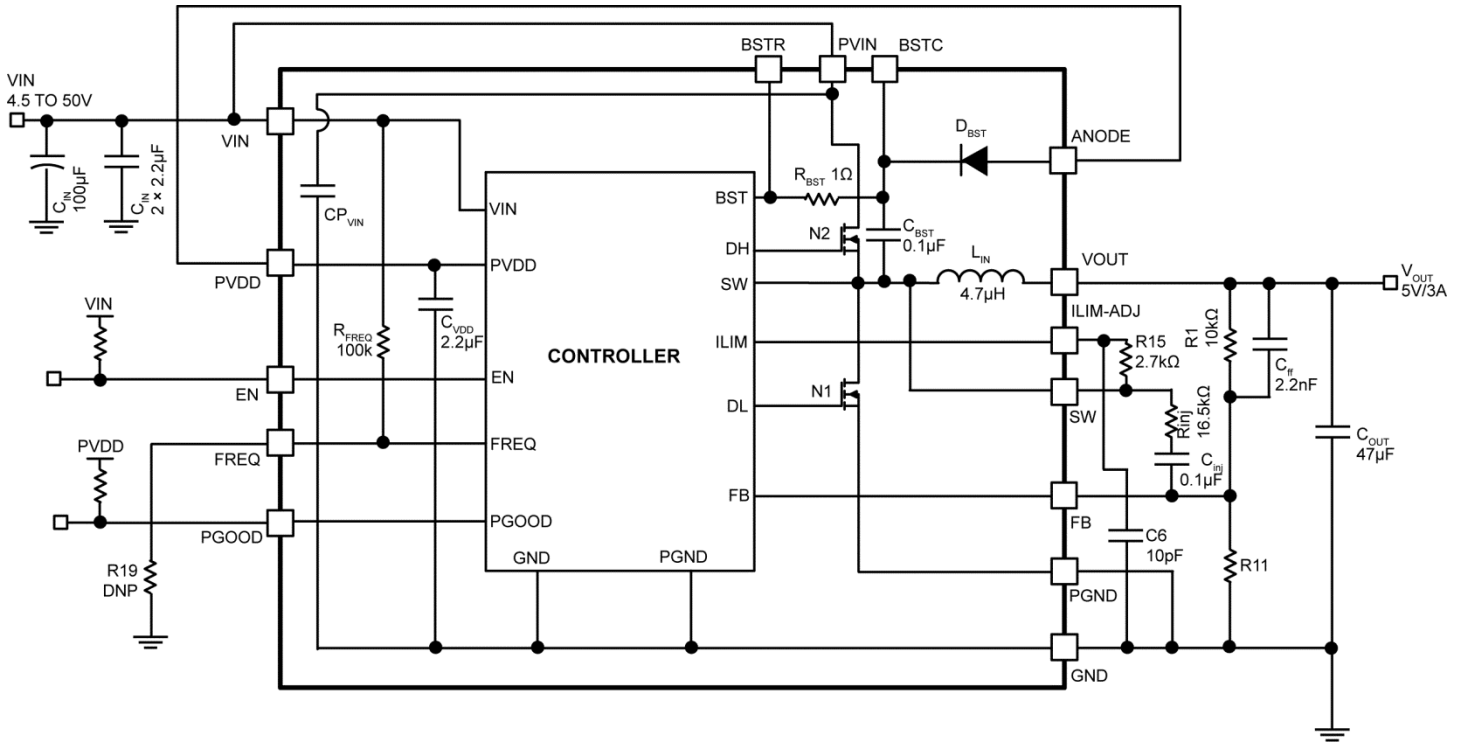

Functional Description

The MIC28303 is an adaptive on-time synchronous buck regulator module built for high-input voltage to low-output voltage conversion applications. The MIC28303 is designed to operate over a wide input voltage range, from 4.5V to 50V, and the output is adjustable with an external resistor divider. An adaptive on-time control scheme is employed to obtain a constant switching frequency and to simplify the control compensation. Hiccup mode over-current protection is implemented by sensing low-side MOSFET's $R_{DS(ON)}$. The device features internal soft-start, enable, UVLO, and thermal shutdown. The module has integrated switching FETs, inductor, bootstrap diode, resistor and capacitor.

Theory of Operation

Per the *Functional Diagram* of the MIC28303 module, the output voltage is sensed by the MIC28303 feedback pin FB via the voltage divider R1 and R11, and compared to a 0.8V reference voltage VREF at the error comparator through a low-gain transconductance (g_m) amplifier. If the feedback voltage decreases and the amplifier output is below 0.8V, then the error comparator will trigger the control logic and generate an ON-time period. The ON-time period length is predetermined by the "Fixed tON Estimator" circuitry:

$$t_{ON(ESTIMATED)} = \frac{V_{OUT}}{V_{IN} \times f_{SW}} \quad \text{Eq. 1}$$

where V_{OUT} is the output voltage, V_{IN} is the power stage input voltage, and f_{SW} is the switching frequency.

At the end of the ON-time period, the internal high-side driver turns off the high-side MOSFET and the low-side driver turns on the low-side MOSFET. The OFF-time period length depends upon the feedback voltage in most cases. When the feedback voltage decreases and the output of the g_m amplifier is below 0.8V, the ON-time period is triggered and the OFF-time period ends. If the OFF-time period determined by the feedback voltage is less than the minimum OFF-time $t_{OFF(MIN)}$, which is about 200ns, the MIC28303 control logic will apply the $t_{OFF(MIN)}$ instead. $t_{OFF(MIN)}$ is required to maintain enough energy in the boost capacitor (C_{BST}) to drive the high-side MOSFET.

The maximum duty cycle is obtained from the 200ns $t_{OFF(MIN)}$:

$$D_{MAX} = \frac{t_S - t_{OFF(MIN)}}{t_S} = 1 - \frac{200ns}{t_S} \quad \text{Eq. 2}$$

Where:

$t_S = 1/f_{SW}$. It is not recommended to use MIC28303 with an OFF-time close to $t_{OFF(MIN)}$ during steady-state operation.

The adaptive ON-time control scheme results in a constant switching frequency in the MIC28303. The actual ON-time and resulting switching frequency will vary with the different rising and falling times of the external MOSFETs. Also, the minimum t_{ON} results in a lower switching frequency in high V_{IN} to V_{OUT} applications. During load transients, the switching frequency is changed due to the varying OFF-time.

To illustrate the control loop operation, both the steady-state and load transient scenarios were analyzed. For easy analysis, the gain of the g_m amplifier is assumed to be 1. With this assumption, the inverting input of the error comparator is the same as the feedback voltage.

Figure 1 shows the MIC28303 control loop timing during steady-state operation. During steady-state, the g_m amplifier senses the feedback voltage ripple, which is proportional to the output voltage ripple plus injected voltage ripple, to trigger the ON-time period. The ON-time is predetermined by the t_{ON} estimator. The termination of the OFF-time is controlled by the feedback voltage. At the valley of the feedback voltage ripple, which occurs when V_{FB} falls below V_{REF} , the OFF period ends and the next ON-time period is triggered through the control logic circuitry.

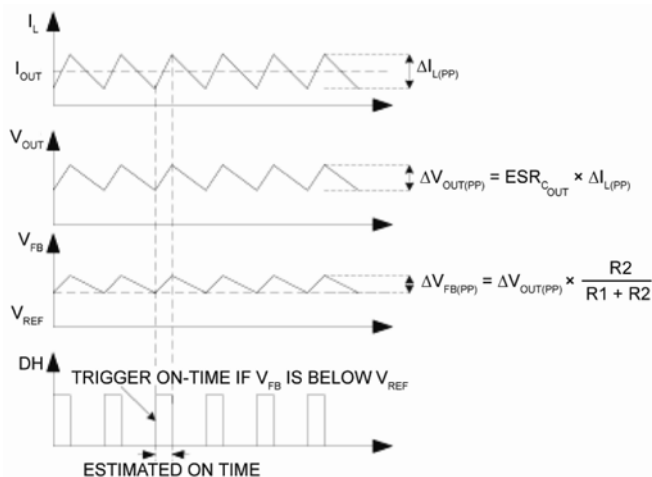

Figure 1. MIC28303 Control Loop Timing

Figure 2 shows the operation of the MIC28303 during a load transient. The output voltage drops due to the sudden load increase, which causes the V_{FB} to be less than V_{REF} . This will cause the error comparator to trigger an ON-time period. At the end of the ON-time period, a minimum OFF-time $t_{OFF(MIN)}$ is generated to charge the bootstrap capacitor (C_{BST}) since the feedback voltage is still below V_{REF} . Then, the next ON-time period is triggered due to the low feedback voltage. Therefore, the switching frequency changes during the load transient, but returns to the nominal fixed frequency once the output has stabilized at the new load current level. With the varying duty cycle and switching frequency, the output recovery time is fast and the output voltage deviation is small.

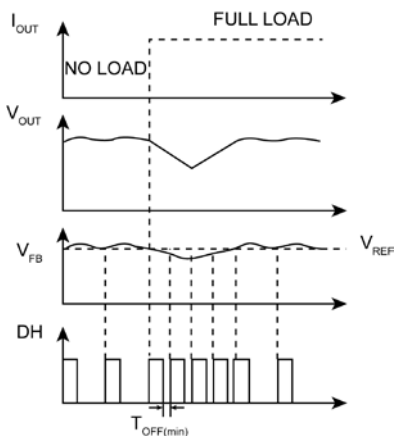

Figure 2. MIC28303 Load Transient Response

Unlike true current-mode control, the MIC28303 uses the output voltage ripple to trigger an ON-time period. The output voltage ripple is proportional to the inductor current ripple if the ESR of the output capacitor is large enough.

In order to meet the stability requirements, the MIC28303 feedback voltage ripple should be in phase with the inductor current ripple and are large enough to be sensed by the g_m amplifier and the error comparator. The recommended feedback voltage ripple is 20mV~100mV over full input voltage range. If a low ESR output capacitor is selected, then the feedback voltage ripple may be too small to be sensed by the g_m amplifier and the error comparator. Also, the output voltage ripple and the feedback voltage ripple are not necessarily in phase with the inductor current ripple if the ESR of the output capacitor is very low. In these cases, ripple injection is required to ensure proper operation. Please refer to “Ripple Injection” subsection in [Application Information](#) for more details about the ripple injection technique.

Discontinuous Mode (MIC28303-1 only)

In continuous mode, the inductor current is always greater than zero; however, at light loads, the MIC28303-1 is able to force the inductor current to operate in discontinuous mode. Discontinuous mode is where the inductor current falls to zero, as indicated by trace (I_L) shown in [Figure 3](#). During this period, the efficiency is optimized by shutting down all the non-essential circuits and minimizing the supply current. The MIC28303-1 wakes up and turns on the high-side MOSFET when the feedback voltage V_{FB} drops below 0.8V.

The MIC28303-1 has a zero crossing comparator (ZC) that monitors the inductor current by sensing the voltage drop across the low-side MOSFET during its ON-time. If the $V_{FB} > 0.8V$ and the inductor current goes slightly negative, then the MIC28303-1 automatically powers down most of the IC circuitry and goes into a low-power mode.

Once the MIC28303-1 goes into discontinuous mode, both DL and DH are low, which turns off the high-side and low-side MOSFETs. The load current is supplied by the output capacitors and V_{OUT} drops. If the drop of V_{OUT} causes V_{FB} to go below V_{REF} , then all the circuits will wake up into normal continuous mode. First, the bias currents of most circuits reduced during the discontinuous mode are restored, and then a t_{ON} pulse is triggered before the drivers are turned on to avoid any possible glitches. Finally, the high-side driver is turned on. [Figure 3](#) shows the control loop timing in discontinuous mode.

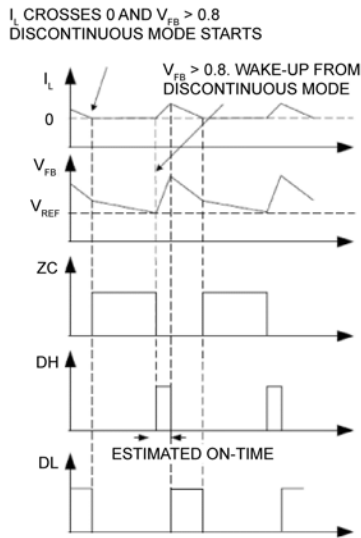

Figure 3. MIC28302-1 Control Loop Timing (Discontinuous Mode)

During discontinuous mode, the bias current of most circuits is substantially reduced. As a result, the total power supply current during discontinuous mode is only about 400µA, allowing the MIC28303-1 to achieve high efficiency in light load applications.

Soft-Start

Soft-start reduces the input power supply surge current at startup by controlling the output voltage rise time. The input surge appears while the output capacitor is charged up. A slower output rise time will draw a lower input surge current.

The MIC28303 implements an internal digital soft-start by making the 0.8V reference voltage V_{REF} ramp from 0 to 100% in about 5ms with 9.7mV steps. Therefore, the output voltage is controlled to increase slowly by a staircase V_{FB} ramp. Once the soft-start cycle ends, the related circuitry is disabled to reduce current consumption. PVDD must be powered up at the same time or after V_{IN} to make the soft-start function correctly.

Current Limit

The MIC28303 uses the $R_{DS(ON)}$ of the low side MOSEFET and external resistor connected from ILIM pin to SW node to decide the current limit.

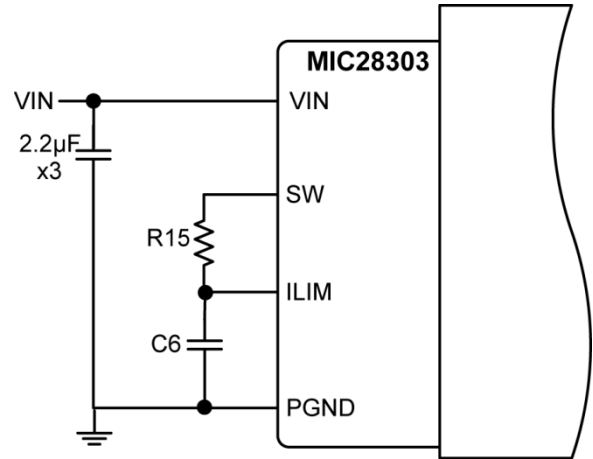

Figure 4. MIC28303 Current-Limiting Circuit

In each switching cycle of the MIC28303, the inductor current is sensed by monitoring the low-side MOSFET in the OFF period. The sensed voltage $V(ILIM)$ is compared with the power ground (PGND) after a blanking time of 150ns. In this way the drop voltage over the resistor R15 (V_{CL}) is compared with the drop over the bottom FET generating the short current limit. The small capacitor (C6) connected from ILIM pin to PGND filters the switching node ringing during the off-time allowing a better short limit measurement. The time constant created by R15 and C6 should be much less than the minimum off time.

The V_{CL} drop allows programming of short limit through the value of the resistor (R15). If the absolute value of the voltage drop on the bottom FET is greater than V_{CL} . In that case the $V(ILIM)$ is lower than PGND and a short circuit event is triggered. A hiccup cycle to treat the short event is generated. The hiccup sequence including the soft start reduces the stress on the switching FETs and protects the load and supply for severe short conditions.

The short-circuit current limit can be programmed by using Equation 3.

$$R15 = \frac{(I_{CLIM} - \Delta I_{L(PP)} \times 0.5) \times R_{DS(ON)} + V_{CL}}{I_{CL}} \quad \text{Eq. 3}$$

Where:

I_{CLIM} = Desired current limit

$R_{DS(ON)}$ = On-resistance of low-side power MOSFET, 57m Ω typically

V_{CL} = Current-limit threshold (typical absolute value is 14mV per the [Electrical Characteristics](#))

I_{CL} = Current-limit source current (typical value is 80 μ A, per the Electrical Characteristics table).

$\Delta I_{L(PP)}$ = Inductor current peak-to-peak, since the inductor is integrated use Equation 4 to calculate the inductor ripple current.

The peak-to-peak inductor current ripple is:

$$\Delta I_{L(PP)} = \frac{V_{OUT} \times (V_{IN(max)} - V_{OUT})}{V_{IN(max)} \times f_{sw} \times L} \quad \text{Eq. 4}$$

The MIC28303 has 4.7 μ H inductor integrated into the module. The typical value of $R_{WINDING(DCR)}$ of this particular inductor is in the range of 45m Ω .

In case of hard short, the short limit is folded down to allow an indefinite hard short on the output without any destructive effect. It is mandatory to make sure that the inductor current used to charge the output capacitance during soft start is under the folded short limit; otherwise the supply will go in hiccup mode and may not be finishing the soft start successfully.

The MOSFET $R_{DS(ON)}$ varies 30% to 40% with temperature; therefore, it is recommended to add a 50% margin to I_{CLIM} in Equation 3 to avoid false current limiting due to increased MOSFET junction temperature rise. [Table 2](#) shows typical output current limit value for a given R15 with C6 = 10pF.

Table 2. Typical Output Current-Limit Value

| R15 | Typical Output Current Limit |
|----------------|------------------------------|
| 1.81k Ω | 3A |
| 2.7k Ω | 6.3A |

Application Information

Simplified Input Transient Circuitry

The 56V absolute maximum rating of the MIC28303 allows simplifying the transient voltage suppressor on the input supply side which is very common in industrial applications. The input supply voltage V_{IN} Figure 5 may be operating at 12V input rail most of the time, but can encounter noise spike of 50V for a short duration. By using MIC28303, which has 56V absolute maximum voltage rating, the input transient suppressor is not needed. Which saves on component count, form factor, and ultimately the system becomes less expensive.

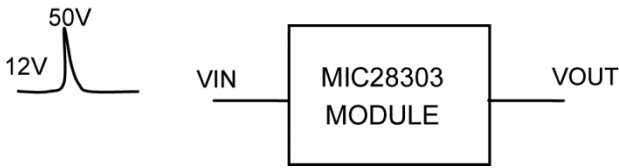

Figure 5. Simplified Input Transient Circuitry

Setting the Switching Frequency

The MIC28303 switching frequency can be adjusted by changing the value of resistor R19. The top resistor of 100kΩ is internal to module and is connected between VIN and FREQ pin, so the value of R19 sets the switching frequency. The switching frequency also depends upon VIN, VOUT and load conditions.

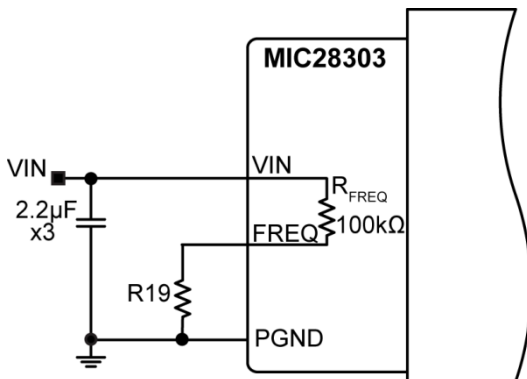

Figure 6. Switching Frequency Adjustment

Equation 5 gives the estimated switching frequency:

$$f_{SW_ADJ} = f_o \times \frac{R19}{R19 + 100k\Omega} \tag{Eq. 5}$$

Where:

f_o = Switching frequency when R19 is open

For more precise setting, it is recommended to use Figure 7:

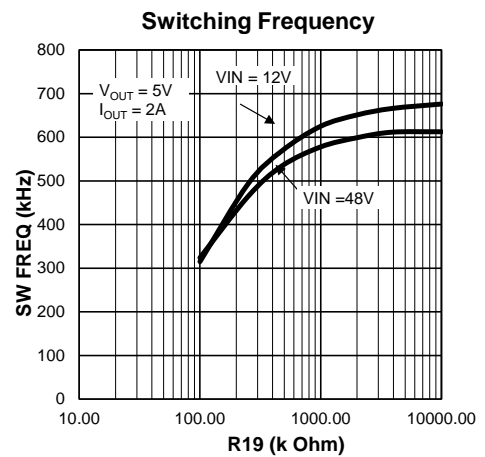

Figure 7. Switching Frequency vs. R19

Output Capacitor Selection

The type of the output capacitor is usually determined by the application and its equivalent series resistance (ESR). Voltage and RMS current capability are two other important factors for selecting the output capacitor. Recommended capacitor types are MLCC, tantalum, low-ESR aluminum electrolytic, OS-CON and POSCAP. The output capacitor's ESR is usually the main cause of the output ripple. The MIC28303 requires ripple injection and the output capacitor ESR effects the control loop from a stability point of view.

The maximum value of ESR is calculated as in Equation 6:

$$ESR_{C_{OUT}} \leq \frac{\Delta V_{OUT(pp)}}{\Delta I_{L(pp)}} \quad \text{Eq. 6}$$

Where:

$\Delta V_{OUT(pp)}$ = Peak-to-peak output voltage ripple

$\Delta I_{L(pp)}$ = Peak-to-peak inductor current ripple

The total output ripple is a combination of the ESR and output capacitance. The total ripple is calculated in Equation 7:

$$\Delta V_{OUT(pp)} = \sqrt{\left(\frac{\Delta I_{L(pp)}}{C_{OUT} \times f_{SW} \times 8}\right)^2 + (\Delta I_{L(pp)} \times ESR_{C_{OUT}})^2} \quad \text{Eq. 7}$$

Where:

D = Duty cycle

C_{OUT} = Output capacitance value

f_{sw} = Switching frequency

As described in the “[Theory of Operation](#)” subsection in [Functional Description](#), the MIC28303 requires at least 20mV peak-to-peak ripple at the FB pin to make the g_m amplifier and the error comparator behave properly. Also, the output voltage ripple should be in phase with the inductor current. Therefore, the output voltage ripple caused by the output capacitors value should be much smaller than the ripple caused by the output capacitor ESR. If low-ESR capacitors, such as ceramic capacitors, are selected as the output capacitors, a ripple injection method should be applied to provide enough feedback voltage ripple. Please refer to the “Ripple Injection” subsection for more details.

The voltage rating of the capacitor should be twice the output voltage for a tantalum and 20% greater for aluminum electrolytic or OS-CON.

The output capacitor RMS current is calculated in Equation 8:

$$I_{C_{OUT}(RMS)} = \frac{\Delta I_{L(pp)}}{\sqrt{12}} \quad \text{Eq. 8}$$

The power dissipated in the output capacitor is:

$$P_{DISS(C_{OUT})} = I_{C_{OUT}(RMS)}^2 \times ESR_{C_{OUT}} \quad \text{Eq. 9}$$

Input Capacitor Selection

The input capacitor for the power stage input PVIN should be selected for ripple current rating and voltage rating. Tantalum input capacitors may fail when subjected to high inrush currents, caused by turning the input supply on. A tantalum input capacitor’s voltage rating should be at least two times the maximum input voltage to maximize reliability. Aluminum electrolytic, OS-CON, and multilayer polymer film capacitors can handle the higher inrush currents without voltage de-rating. The input voltage ripple will primarily depend on the input capacitor’s ESR. The peak input current is equal to the peak inductor current, so:

$$\Delta V_{IN} = I_{L(pk)} \times ESR_{C_{IN}} \quad \text{Eq. 10}$$

The input capacitor must be rated for the input current ripple. The RMS value of input capacitor current is determined at the maximum output current. Assuming the peak-to-peak inductor current ripple is low:

$$I_{C_{IN}(RMS)} \approx I_{OUT(max)} \times \sqrt{D \times (1-D)} \quad \text{Eq. 11}$$

The power dissipated in the input capacitor is:

$$P_{DISS(C_{IN})} = I_{C_{IN}(RMS)}^2 \times ESR_{C_{IN}} \quad \text{Eq. 12}$$

The general rule is to pick the capacitor with a ripple current rating equal to or greater than the calculated worst ($V_{IN,MAX}$) case RMS capacitor current. Its voltage rating should be 20% to 50% higher than the maximum input voltage. Typically the input ripple (dV) needs to be kept down to less than $\pm 10\%$ of input voltage. The ESR also increases the input ripple.

Equation 13 should be used to calculate the input capacitor. Also it is recommended to keep some margin on the calculated value:

$$C_{IN} \approx \frac{I_{OUT(max)} \times (1-D)}{F_{SW} \times dV} \quad \text{Eq. 13}$$

Where:

dV = The input ripple and F_{SW} is the switching frequency

Output Voltage Setting Components

The MIC28303 requires two resistors to set the output voltage as shown in Figure 8:

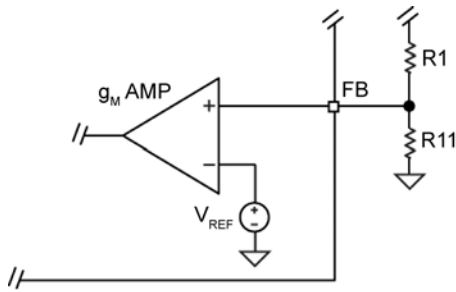

Figure 8. Voltage-Divider Configuration

The output voltage is determined by Equation 14:

$$V_{OUT} = V_{FB} \times \left(1 + \frac{R1}{R11}\right) \quad \text{Eq. 14}$$

Where:

$V_{FB} = 0.8V$

A typical value of R1 used on the standard evaluation board is 10kΩ. If R1 is too large, it may allow noise to be introduced into the voltage feedback loop. If R1 is too small in value, it will decrease the efficiency of the power supply, especially at light loads. Once R1 is selected, R11 can be calculated using Equation 15:

$$R11 = \frac{V_{FB} \times R1}{V_{OUT} - V_{FB}} \quad \text{Eq. 15}$$

Ripple Injection

The V_{FB} ripple required for proper operation of the MIC28303 g_M amplifier and error comparator is 20mV to 100mV. However, the output voltage ripple is generally designed as 1% to 2% of the output voltage. For a low output voltage, such as a 1V, the output voltage ripple is only 10mV to 20mV, and the feedback voltage ripple is less than 20mV. If the feedback voltage ripple is so small that the g_M amplifier and error comparator cannot sense it, then the MIC28303 will lose control and the output voltage is not regulated. In order to have some amount of V_{FB} ripple, a ripple injection method is applied for low output voltage ripple applications. The table 2 summarizes the ripple injection component values for ceramic output capacitor.

The applications are divided into three situations according to the amount of the feedback voltage ripple:

1. Enough ripple at the feedback voltage due to the large ESR of the output capacitors (Figure 9):

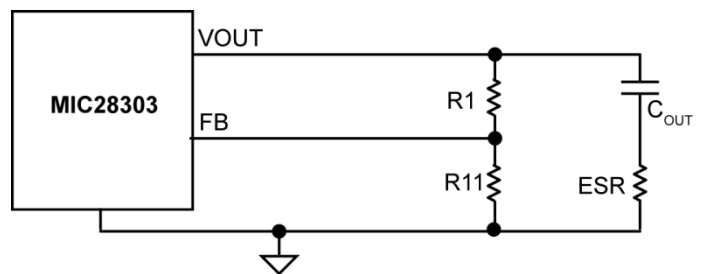

Figure 9. Enough Ripple at FB

As shown in Figure 10, the converter is stable without any ripple injection.

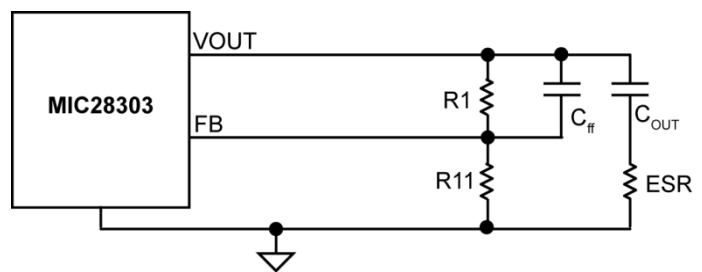

Figure 10. Inadequate Ripple at FB

The feedback voltage ripple is:

$$\Delta V_{FB(PP)} = \frac{R11}{R1 + R11} \times ESR_{C_{OUT}} \times \Delta I_{L(PP)} \quad \text{Eq. 16}$$

Where:

$\Delta I_{L(PP)}$ = The peak-to-peak value of the inductor current ripple

- Inadequate ripple at the feedback voltage due to the small ESR of the output capacitors, such is the case with ceramic output capacitor.

The output voltage ripple is fed into the FB pin through a feed-forward capacitor C_{ff} in this situation, as shown in [Figure 11](#). The typical C_{ff} value is between 1nF and 100nF.

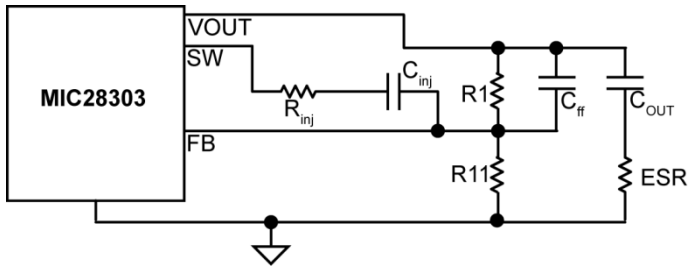

Figure 11. Invisible Ripple at FB

With the feed-forward capacitor, the feedback voltage ripple is very close to the output voltage ripple:

$$\Delta V_{FB(PP)} \approx ESR \times \Delta I_{L(PP)} \quad \text{Eq. 17}$$

- Virtually no ripple at the FB pin voltage due to the very-low ESR of the output capacitors.

In this situation, the output voltage ripple is less than 20mV. Therefore, additional ripple is injected into the FB pin from the switching node SW via a resistor R_{inj} and a capacitor C_{inj} , as shown in [Figure 11](#). The injected ripple is:

$$\Delta V_{FB(PP)} = V_{IN} \times K_{div} \times D \times (1-D) \times \frac{1}{f_{SW} \times \tau} \quad \text{Eq. 18}$$

$$K_{div} = \frac{R1//R11}{R_{inj} + R1//R11} \quad \text{Eq. 19}$$

Where:

V_{IN} = Power stage input voltage

D = Duty cycle

f_{SW} = Switching frequency

$\tau = (R1//R11//R_{inj}) \times C_{ff}$

In Equations 18 and 19, it is assumed that the time constant associated with C_{ff} must be much greater than the switching period:

$$\frac{1}{f_{SW} \times \tau} = \frac{T}{\tau} \ll 1 \quad \text{Eq. 20}$$

If the voltage divider resistors $R1$ and $R11$ are in the k Ω range, then a C_{ff} of 1nF to 100nF can easily satisfy the large time constant requirements. Also, a 100nF injection capacitor C_{inj} is used in order to be considered as short for a wide range of the frequencies.

The process of sizing the ripple injection resistor and capacitors is:

Step 1. Select C_{ff} to feed all output ripples into the feedback pin and make sure the large time constant assumption is satisfied. Typical choice of C_{ff} is 1nF to 100nF if $R1$ and $R11$ are in k Ω range.

Step 2. Select R_{inj} according to the expected feedback voltage ripple using Equation 22:

$$K_{div} = \frac{\Delta V_{FB(PP)}}{V_{IN}} \times \frac{f_{SW} \times \tau}{D \times (1-D)} \quad \text{Eq. 21}$$

Then the value of R_{inj} is obtained as:

$$R_{inj} = (R1//R11) \times \left(\frac{1}{K_{div}} - 1 \right) \quad \text{Eq. 22}$$

Step 3. Select C_{inj} as 100nF, which could be considered as short for a wide range of the frequencies.

[Table 3](#) summarizes the typical value of components for particular input and output voltage, and 600kHz switching frequency design, for details refer to the [Bill of Materials](#) section.

Table 3. Recommended Component Values for 600kHz Switching Frequency

| V _{OUT} | V _{IN} | R3 (R _{inj}) | R1 (Top Feedback Resistor) | R11 (Bottom Feedback Resistor) | R19 | C10 (C _{inj}) | C12 (C _{ff}) | C _{OUT} |
|------------------|-----------------|---------------------------|-------------------------------|-----------------------------------|-----|----------------------------|---------------------------|--------------------------|
| 0.9V | 5V to 50V | 16.5kΩ | 10kΩ | 80.6kΩ | DNP | 0.1μF | 2.2nF | 47μF/6.3V or 2 x 22μF |
| 1.2V | 5V to 50V | 16.5kΩ | 10kΩ | 20kΩ | DNP | 0.1μF | 2.2nF | 47μF/6.3V or 2 x 22μF |
| 1.8V | 5V to 50V | 16.5kΩ | 10kΩ | 8.06kΩ | DNP | 0.1μF | 2.2nF | 47μF/6.3V or 2 x 22μF |
| 2.5V | 5V to 50V | 16.5kΩ | 10kΩ | 4.75kΩ | DNP | 0.1μF | 2.2nF | 47μF/6.3V or 2 x 22μF |
| 3.3V | 5V to 50V | 16.5kΩ | 10kΩ | 3.24kΩ | DNP | 0.1μF | 2.2nF | 47μF/6.3V or 2 x 22μF |
| 5V | 7V to 50V | 16.5kΩ | 10kΩ | 1.9kΩ | DNP | 0.1μF | 2.2nF | 47μF/6.3V or 2 x 22μF |
| 12V | 18V to 50V | 23.2kΩ | 10kΩ | 715Ω | DNP | 0.1μF | 2.2nF | 47μF/16V or 2 x 22μF |

Thermal Measurements and Safe Operating Area

Measuring the IC's case temperature is recommended to ensure it is within its operating limits. Although this might seem like a very elementary task, it is easy to get erroneous results. The most common mistake is to use the standard thermal couple that comes with a thermal meter. This thermal couple wire gauge is large, typically 22 gauge, and behaves like a heatsink, resulting in a lower case measurement.

Two methods of temperature measurement are using a smaller thermal couple wire or an infrared thermometer. If a thermal couple wire is used, it must be constructed of 36-gauge wire or higher (smaller wire size) to minimize the wire heat-sinking effect. In addition, the thermal couple tip must be covered in either thermal grease or thermal glue to make sure that the thermal couple junction is making good contact with the case of the IC. Omega brand thermal couple (5SC-TT-K-36-36) is adequate for most applications.

Wherever possible, an infrared thermometer is recommended. The measurement spot size of most infrared thermometers is too large for an accurate reading on a small form factor ICs.

However, an IR thermometer from Optris has a 1mm spot size, which makes it a good choice for measuring the hottest point on the case. An optional stand makes it easy to hold the beam on the IC for long periods of time.

The safe operating area (SOA) of the MIC28303 is shown in the [Typical Characteristics – 275kHz Switching Frequency](#) section. These thermal measurements were taken on MIC28303 evaluation board. Since the MIC28303 is an entire system comprised of switching regulator controller, MOSFETs and inductor, the part needs to be considered as a system. The SOA curves will give guidance to reasonable use of the MIC28303.

Emission Characteristics of MIC28303

The MIC28303 integrates switching components in a single package, so the MIC28303 has reduced emission compared to standard buck regulator with external MOSFETS and inductors. The radiated EMI scans for MIC28303 are shown in the [Typical Characteristics](#) section. The limit on the graph is per EN55022 Class B standard.

PCB Layout Guidelines

Warning: To minimize EMI and output noise, follow these layout recommendations.

PCB layout is critical to achieve reliable, stable and efficient performance. A ground plane is required to control EMI and minimize the inductance in power, signal and return paths.

The following figures optimized from small form factor point of view shows top and bottom layer of a four layer PCB. It is recommended to use mid layer 1 as a continuous ground plane.

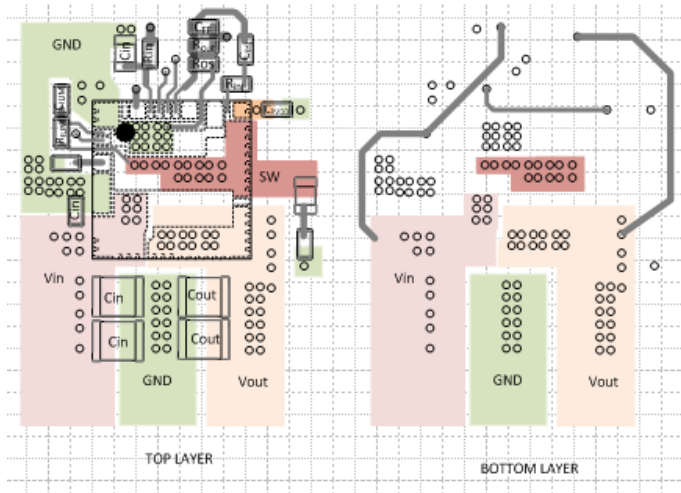

Figure 12. Top And Bottom Layer of a Four-Layer Board

The following guidelines should be followed to insure proper operation of the MIC28303 converter:

IC

- The analog ground pin (GND) must be connected directly to the ground planes. Do not route the GND pin to the PGND pin on the top layer.
- Place the IC close to the point of load (POL).
- Use fat traces to route the input and output power lines.
- Analog and power grounds should be kept separate and connected at only one location.

Input Capacitor

- Place the input capacitors on the same side of the board and as close to the IC as possible.
- Place several vias to the ground plane close to the input capacitor ground terminal.
- Use either X7R or X5R dielectric input capacitors. Do not use Y5V or Z5U type capacitors.
- Do not replace the ceramic input capacitor with any other type of capacitor. Any type of capacitor can be placed in parallel with the input capacitor.
- If a Tantalum input capacitor is placed in parallel with the input capacitor, it must be recommended for switching regulator applications and the operating voltage must be derated by 50%.
- In “Hot-Plug” applications, a Tantalum or Electrolytic bypass capacitor must be used to limit the over-voltage spike seen on the input supply with power is suddenly applied.

RC Snubber

- Place the RC snubber on the same side of the board and as close to the SW pin as possible.

SW Node

- Do not route any digital lines underneath or close to the SW node.
- Keep the switch node (SW) away from the feedback (FB) pin.

Output Capacitor

- Use a wide trace to connect the output capacitor ground terminal to the input capacitor ground terminal.
- Phase margin will change as the output capacitor value and ESR changes. Contact the factory if the output capacitor is different from what is shown in the BOM.
- The feedback trace should be separate from the power trace and connected as close as possible to the output capacitor. Sensing a long high-current load trace can degrade the DC load regulation.

Typical Application Schematic

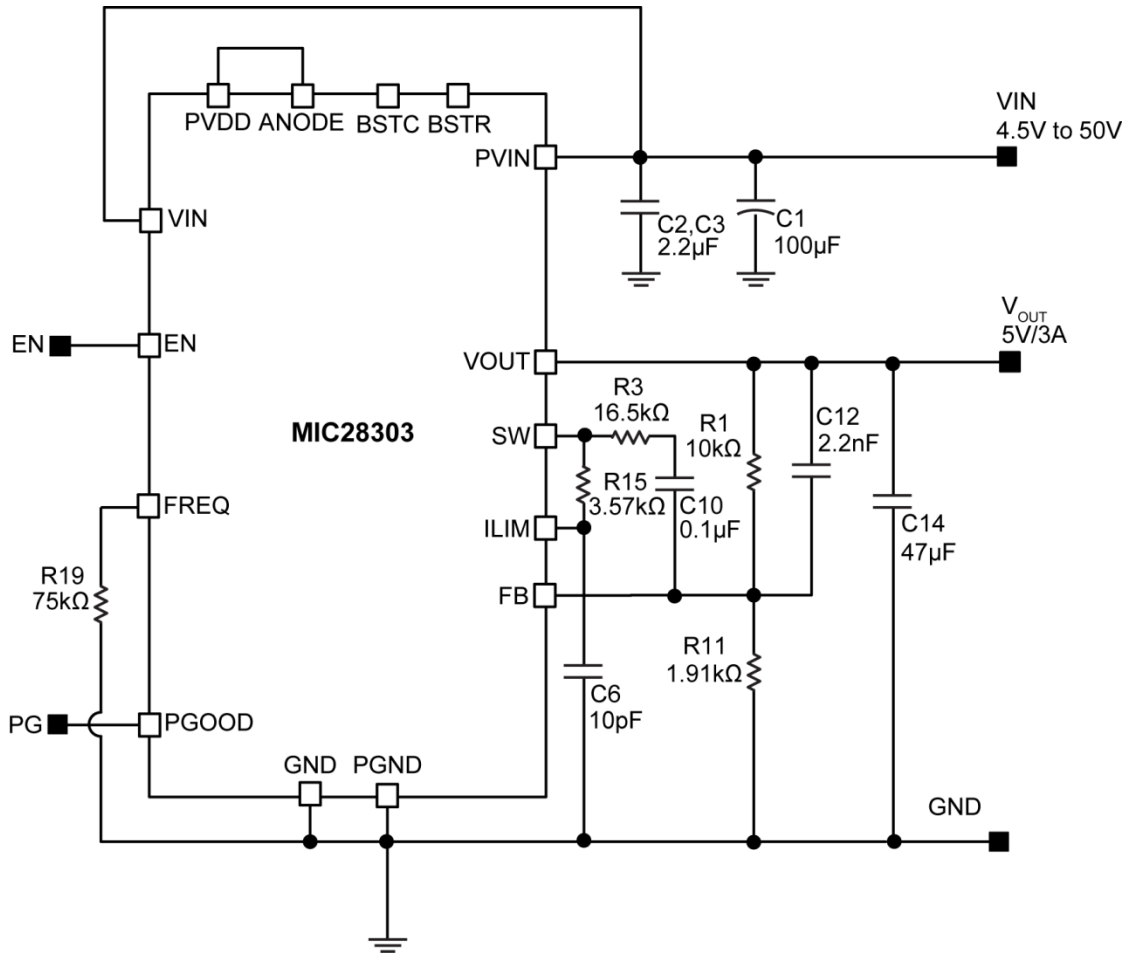

Figure 13. Typical Application Schematic of MIC28303

Bill of Materials

| Item | Part Number | Manufacturer | Description | Qty. |
|--------|--------------------|------------------------------|--|------|
| C1 | EEU-FC2A101 | Panasonic ⁽⁶⁾ | 100µF Aluminum Capacitor, 100V | 1 |
| C2, C3 | GRM32ER72A225K | Murata ⁽⁷⁾ | 2.2µF/100V Ceramic Capacitor, X7R, Size 1210 | 2 |
| | C3225X7R2A225K | TDK ⁽⁸⁾ | | |
| | 12101C225KAT2A | AVX ⁽⁹⁾ | | |
| C6 | GCM1885C2A100JA16D | Murata | 10pF, 100V, 0603, NPO | 1 |
| | 06031A100JAT2A | AVX | | |
| C12 | GRM188R72A222KA01D | Murata | 2.2nF/100V Ceramic Capacitor, X7R, Size 0603 | 1 |
| | 06031C222KAT2A | AVX | | |
| | C1608X7R2A222K | TDK | | |
| C14 | GRM31CR60J476ME19K | Murata | 47µF/6.3V Ceramic Capacitor, X5R, Size 1210 | 1 |
| | 12106D476MAT2A | AVX | | |
| C10 | GRM188R71H104KA93D | Murata | 0.1µF/6.3V Ceramic Capacitor, X7R, Size 0603 | 1 |
| | 06035C104KAT2A | AVX | | |
| | C1608X7R1H104K | TDK | | |
| R1 | CRCW060310K0FKEA | Vishay Dale ⁽¹⁰⁾ | 10kΩ Resistor, Size 0603, 1% | 1 |
| R3 | CRCW06031652F | Vishay Dale | 16.5kΩ Resistor, Size 0603, 1% | 1 |
| R11 | CRCW06031K91FKEA | Vishay Dale | 1.91kΩ Resistor, Size 0603, 1% | 1 |
| R15 | CRCW06033K57FKEA | Vishay Dale | 3.57kΩ Resistor, Size 0603, 1% | 1 |
| R19 | CRCW060375K0FKEA | Vishay Dale | 75kΩ Resistor, Size 0603, 1% | 1 |
| U1 | MIC28303-1YMP | Micrel, Inc. ⁽¹¹⁾ | 50V, 3A Power Module | 1 |
| | MIC28303-2YMP | | | |

Notes:6. Panasonic: www.panasonic.com.7. Murata: www.murata.com.8. TDK: www.tdk.com.9. AVX: www.avx.com.10. Vishay: www.vishay.com.11. Micrel, Inc.: www.micrel.com.

Package Information⁽¹²⁾

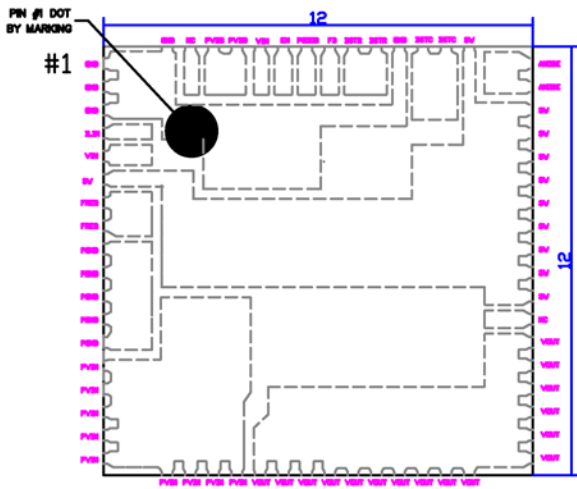

Top View
NOTE: 1, 2, 3

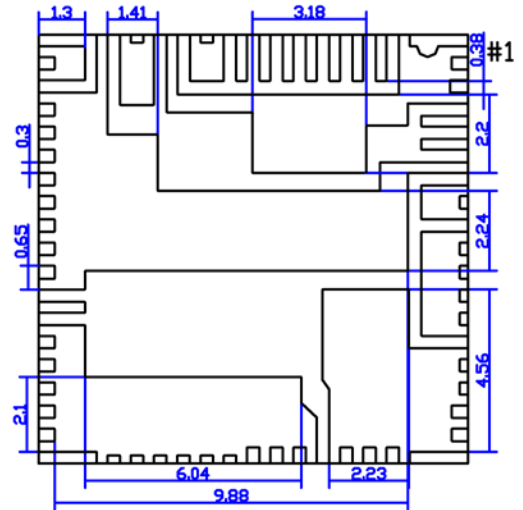

Bottom View
NOTE: 1, 2, 3

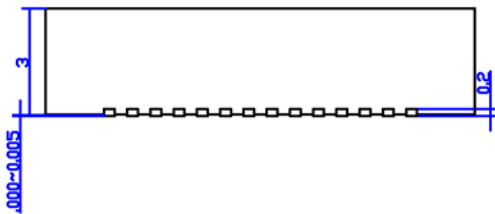

Top View
NOTE: 1, 2, 3

64-Pin 12mm x 12mm QFN (MP)

Note:

12. Package information is correct as of the publication date. For updates and most current information, go to www.micrel.com.

Recommended Land Pattern

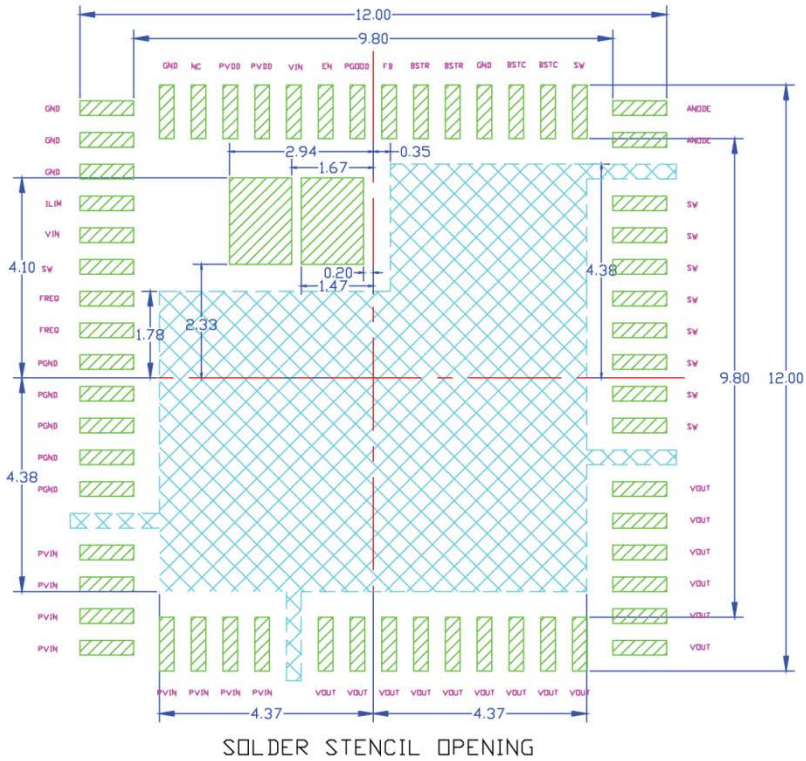
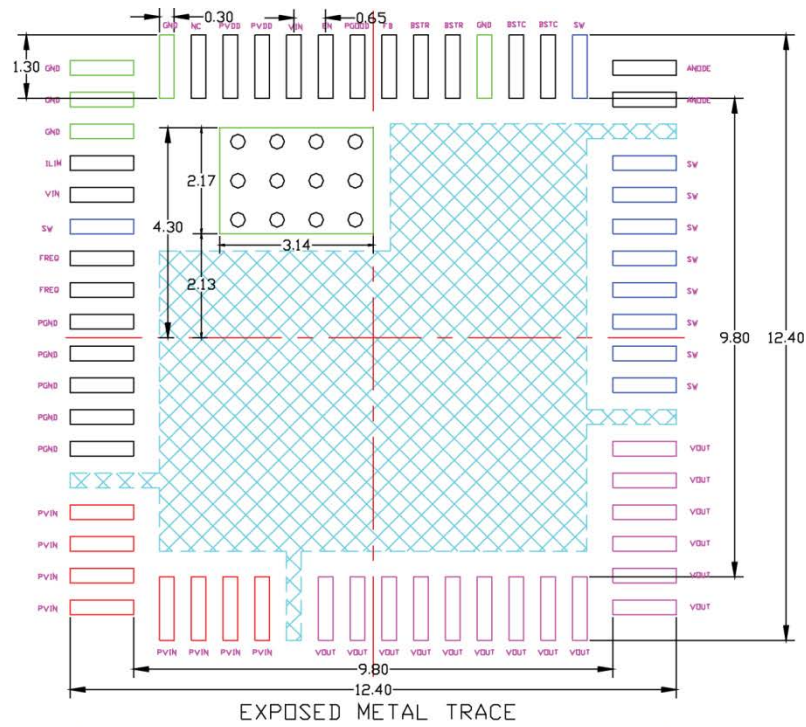

Recommended Land Pattern (Continued)

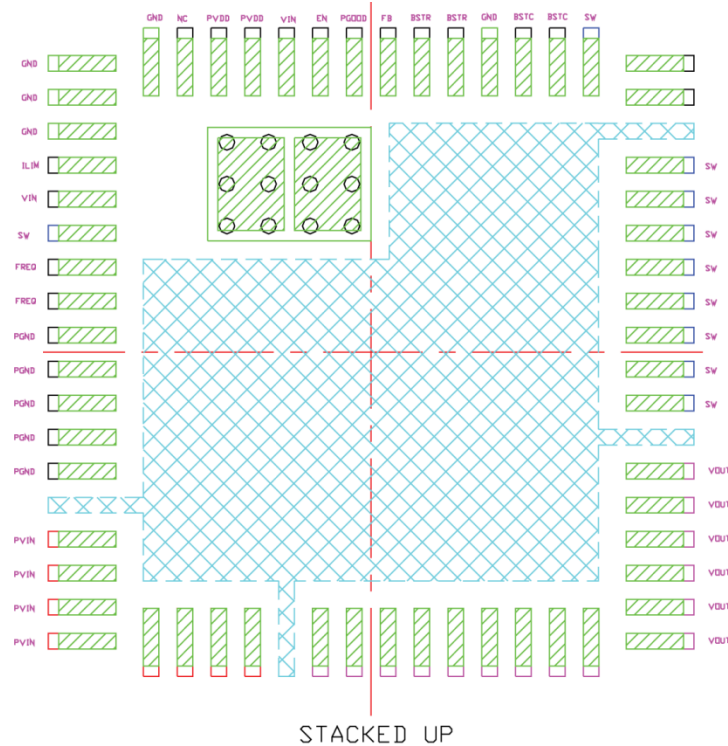

NOTE:

1. MAX PACKAGE WARPAGE IS 0.05 MM
2. MAX ALLOWABLE BURR IS 0.076MM IN ALL DIRECTIONS
3. PIN #1 IS ON TOP WILL BE LASER MARKED
4. BLACK CIRCLES IN LAND PATTERN REPRESENT THERMAL VIA, RECOMMENDED SIZE IS 0.30-0.35mm, AT 0.80mm PITCH & SHOULD BE CONNECTED TO GND FOR MAXIMUM PERFORMANCE.
5. GREEN RECTANGLES (SHADED AREA) REPRESENT SOLDER STENCIL OPENING ON EXPOSED PAD AREA.
6. CYAN COLORED SHADED PAD REPRESENT EXPOSED TRACE KEEP OUT AREA.

MICREL, INC. 2180 FORTUNE DRIVE SAN JOSE, CA 95131 USA
TEL +1 (408) 944-0800 FAX +1 (408) 474-1000 WEB <http://www.micrel.com>

Micrel, Inc. is a leading global manufacturer of IC solutions for the worldwide high performance linear and power, LAN, and timing & communications markets. The Company's products include advanced mixed-signal, analog & power semiconductors; high-performance communication, clock management, MEMs-based clock oscillators & crystal-less clock generators, Ethernet switches, and physical layer transceiver ICs. Company customers include leading manufacturers of enterprise, consumer, industrial, mobile, telecommunications, automotive, and computer products. Corporation headquarters and state-of-the-art wafer fabrication facilities are located in San Jose, CA, with regional sales and support offices and advanced technology design centers situated throughout the Americas, Europe, and Asia. Additionally, the Company maintains an extensive network of distributors and reps worldwide.

Micrel makes no representations or warranties with respect to the accuracy or completeness of the information furnished in this datasheet. This information is not intended as a warranty and Micrel does not assume responsibility for its use. Micrel reserves the right to change circuitry, specifications and descriptions at any time without notice. No license, whether express, implied, arising by estoppel or otherwise, to any intellectual property rights is granted by this document. Except as provided in Micrel's terms and conditions of sale for such products, Micrel assumes no liability whatsoever, and Micrel disclaims any express or implied warranty relating to the sale and/or use of Micrel products including liability or warranties relating to fitness for a particular purpose, merchantability, or infringement of any patent, copyright, or other intellectual property right.

Micrel Products are not designed or authorized for use as components in life support appliances, devices or systems where malfunction of a product can reasonably be expected to result in personal injury. Life support devices or systems are devices or systems that (a) are intended for surgical implant into the body or (b) support or sustain life, and whose failure to perform can be reasonably expected to result in a significant injury to the user. A Purchaser's use or sale of Micrel Products for use in life support appliances, devices or systems is a Purchaser's own risk and Purchaser agrees to fully indemnify Micrel for any damages resulting from such use or sale.

© 2015 Micrel, Incorporated.

Mouser Electronics

Authorized Distributor

Click to View Pricing, Inventory, Delivery & Lifecycle Information:

[Micrel:](#)

[MIC28303-2YMP TR](#) [MIC28303-2YMP-TR](#) [MIC28303-1YMP-TR](#)