

General Description

The LM2576 series of monolithic integrated circuits provide all the active functions for a step-down (buck) switching regulator. Fixed versions are available with a 3.3V, 5V, or 12V fixed output. Adjustable versions have an output voltage range from 1.23V to 37V. Both versions are capable of driving a 3A load with excellent line and load regulation.

These regulators are simple to use because they require a minimum number of external components and include internal frequency compensation and a fixed-frequency oscillator.

The LM2576 series offers a high efficiency replacement for popular three-terminal adjustable linear regulators. It substantially reduces the size of the heat sink, and in many cases no heat sink is required.

A standard series of inductors available from several different manufacturers are ideal for use with the LM2576 series. This feature greatly simplifies the design of switch-mode power supplies.

The feedback voltage is guaranteed to $\pm 2\%$ tolerance for adjustable versions, and the output voltage is guaranteed to $\pm 3\%$ for fixed versions, within specified input voltages and output load conditions. The oscillator frequency is guaranteed to $\pm 10\%$. External shutdown is included, featuring less than 200 μ A standby current. The output switch includes cycle-by-cycle current limiting and thermal shutdown for full protection under fault conditions.

Features

- 3.3V, 5V, 12V, and adjustable output versions
- Voltage over specified line and load conditions:
Fixed version: $\pm 3\%$ max. output voltage
Adjustable version: $\pm 2\%$ max. feedback voltage
- Guaranteed 3A output current
- Wide input voltage range:
4V to 40V
- Wide output voltage range
1.23V to 37V
- Requires only 4 external components
- 52kHz fixed frequency internal oscillator
- Low power standby mode I_Q typically < 200 μ A
- 80% efficiency (adjustable version typically > 80%)
- Uses readily available standard inductors
- Thermal shutdown and current limit protection
- 100% electrical thermal limit burn-in

Applications

- Simple high-efficiency step-down (buck) regulator
- Efficient pre-regulator for linear regulators
- On-card switching regulators
- Positive to negative converter (inverting Buck-Boost)
- Isolated Flyback Converter using minimum number of external components
- Negative Boost Converter

Typical Applications

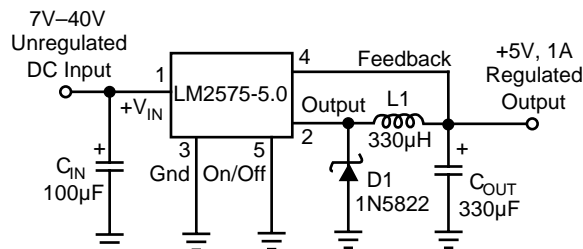

Note: Pin numbers are for TO-220 Package

Fixed Regulator in Typical Application

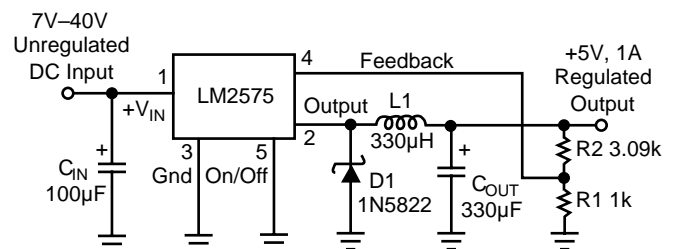

Note: Pin numbers are for TO-220 Package

$$V_{OUT} = 1.23 \left(1 + \frac{R_2}{R_1} \right)$$

Adjustable Regulator in Fixed Output Application

Ordering Information

Part Number [†]		Range	Temperature Package
Standard	RoHS Compliant**		
LM2576BT ^{††}	LM2576WT ^{††}	-40°C to +85°C	TO-220-5
LM2576-3.3BT [†]	LM2576-3.3WT [†]	-40°C to +85°C	TO-220-5
LM2576-5.0BT [†]	LM2576-5.0WT [†]	-40°C to +85°C	TO-220-5
LM2576-12BT [†]	LM2576-12WT [†]	-40°C to +85°C	TO-220-5
LM2576BU*	LM2576WU*	-40°C to +85°C	TO-263-5
LM2576-3.3BU	LM2576-3.3WU	-40°C to +85°C	TO-263-5
LM2576-5.0BU	LM2576-5.0WU	-40°C to +85°C	TO-263-5
LM2576-12BU	LM2576-12WU	-40°C to +85°C	TO-263-5

* Adjustable output regulators.

**RoHS compliant with "hot-melting solder" exemption.

[†] Contact factory for bent or staggered leads option.

Pin Configurations

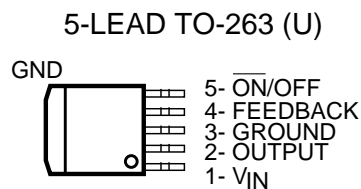
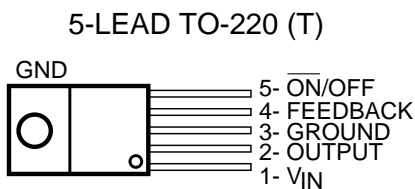

Absolute Maximum Ratings (Note 1)

Maximum Supply Voltage	45V
ON/OFF Pin Input Voltage	$-0.3V \leq V \leq +40V$
Output Voltage to Ground (Steady State)	-1V
Power Dissipation	Internally Limited
Storage Temperature Range	-65°C to $+150^{\circ}\text{C}$
Minimum ESD Rating	
C = 100pF, R = 1.5k Ω	2 kV
FB Pin	1 kV
Lead Temperature (soldering, 10 sec.)	260°C
Maximum Junction Temperature	150°C

Operating Ratings

Temperature Range	$-40^{\circ}\text{C} \leq T_J \leq +125^{\circ}\text{C}$
Supply Voltage	40V

Electrical Characteristics Specifications with standard typeface are for $T_J = 25^{\circ}\text{C}$, and those with **boldface type** apply over **full Operating Temperature Range**. Unless otherwise specified, $V_{IN} = 12\text{V}$, and $I_{LOAD} = 500\text{mA}$.

Symbol	Parameter	Conditions	Typ	LM2576	
				Limit (Note 2)	Units (Limits)
SYSTEM PARAMETERS, ADJUSTABLE REGULATORS (Note 3) Test Circuit <i>Figure 1</i>					
V_{OUT}	Feedback Voltage	$V_{IN} = 12\text{V}$, $I_{LOAD} = 0.5\text{A}$ $V_{OUT} = 5\text{V}$	1.230	1.217 1.243	V V(min) V(max)
V_{OUT}	Feedback Voltage LM2576	$0.5\text{A} \leq I_{LOAD} \leq 3\text{A}$, $8\text{V} \leq V_{IN} \leq 40\text{V}$ $V_{OUT} = 5\text{V}$	1.230	1.193/ 1.180 1.267/ 1.280	V V(min) V(max)
η	Efficiency	$V_{IN} = 12\text{V}$, $I_{LOAD} = 3\text{A}$, $V_{OUT} = 5\text{V}$	82		%
SYSTEM PARAMETERS, 3.3V REGULATORS (Note 3) Test Circuit <i>Figure 1</i>					
V_{OUT}	Output Voltage	$V_{IN} = 12\text{V}$, $I_{LOAD} = 0.5\text{A}$ $V_{OUT} = 3.3\text{V}$	3.3	3.234 3.366	V V(min) V(max)
V_{OUT}	Output Voltage LM2576-3.3	$0.5\text{A} \leq I_{LOAD} \leq 3\text{A}$, $6\text{V} \leq V_{IN} \leq 40\text{V}$ $V_{OUT} = 3.3\text{V}$	3.3	3.168/ 3.135 3.432/ 3.465	V V(min) V(max)
η	Efficiency	$V_{IN} = 12\text{V}$, $I_{LOAD} = 3\text{A}$	75		%
SYSTEM PARAMETERS, 5V REGULATORS (Note 3) Test Circuit <i>Figure 1</i>					
V_{OUT}	Output Voltage	$V_{IN} = 12\text{V}$, $I_{LOAD} = 0.5\text{A}$ $V_{OUT} = 5\text{V}$	5.0	4.900 5.100	V V(min) V(max)
V_{OUT}	Output Voltage LM2576-5.0	$0.5\text{A} \leq I_{LOAD} \leq 3\text{A}$, $8\text{V} \leq V_{IN} \leq 40\text{V}$ $V_{OUT} = 5\text{V}$	5.0	4.800/ 4.750 5.200/ 5.250	V V(min) V(max)
η	Efficiency	$V_{IN} = 12\text{V}$, $I_{LOAD} = 3\text{A}$	82		%
SYSTEM PARAMETERS, 12V REGULATORS (Note 3) Test Circuit <i>Figure 1</i>					
V_{OUT}	Output Voltage	$V_{IN} = 25\text{V}$, $I_{LOAD} = 0.5\text{A}$ $V_{OUT} = 12\text{V}$	12	11.760 12.240	V V(min) V(max)
V_{OUT}	Output Voltage LMLM2576-12	$0.5\text{A} \leq I_{LOAD} \leq 3\text{A}$, $15\text{V} \leq V_{IN} \leq 40\text{V}$ $V_{OUT} = 12\text{V}$	12	11.520/ 11.400 12.480/ 12.600	V V(min) V(max)
η	Efficiency	$V_{IN} = 25\text{V}$, $I_{LOAD} = 3\text{A}$	88		%

Electrical Characteristics (continued)

Symbol	Parameter	Conditions	Typ	LM2576	Units (Limits)
				Limit (Note 2)	
DEVICE PARAMETERS, ADJUSTABLE REGULATOR					
I_B	Feedback Bias Current	$V_{OUT} = 5V$	50	100/500	nA
DEVICE PARAMETERS, FIXED and ADJUSTABLE REGULATORS					
f_O	Oscillator Frequency		52	47/42 58/63	kHz kHz (min) kHz (max)
V_{SAT}	Saturation Voltage	$I_{OUT} = 3A$ (Note 4)	1.4	1.8/2.0	V V(max)
DC	Max Duty Cycle (ON)	(Note 5)	98	93	% %(min)
I_{CL}	Current Limit	Peak Current, $t_{ON} \leq 3\mu s$ (Note 4)	5.8	4.2/3.5 6.9/7.5	A A(min) A(max)
I_L	Output Leakage Current	$V_{IN} = 40V$, (Note 6), (Note 6)	7.5	2 30	mA(max) mA mA(max)
I_Q	Quiescent Current	(Note 6)	5	10	mA mA(max)
I_{STBY}	Standby Quiescent Current	ON/OFF Pin = 5V (OFF)	50	200	μA μA (max)
θ_{JA} θ_{JA} θ_{JC}	Thermal Resistance	T,U Package, Junction to Ambient (Note 7) T,U Package, Junction to Ambient (Note 8) T,U Package, Junction to Case	65 45 2		$^{\circ}C/W$

Electrical Characteristics (continued)

Symbol	Parameter	Conditions	Typ	LM2576	Units (Limits)
				Limit (Note 2)	

ON/OFF CONTROL, FIXED and ADJUSTABLE REGULATORS Test Circuit *Figure 1*

V_{IH}	ON/OFF Pin Logic	$V_{OUT} = 0V$	1.4	2.2/2.4	V(min)
V_{IL}	Input Level	$V_{OUT} = 5V$	1.2	1.0/0.8	V(max)
I_{IH}	ON /OFF Pin Logic Current	ON /OFF Pin = 5V (OFF)	4	30	μA $\mu A(max)$
I_{IL}		ON/OFF Pin = 0V (ON)	0.01	10	μA $\mu A(max)$

Note 1: Absolute Maximum Rating indicate limits beyond which damage to the device may occur. Operating Ratings indicate conditions for which the device is intended to be functional, but do not guarantee specific performance limits. For guaranteed specifications and test conditions, see the Electrical Characteristics.

Note 2: All limits guaranteed at room temperature (standard type face) and at **temperature extremes (bold type face)**. All room temperature limits are 100% production tested. All limits at **temperature extreme** are guaranteed via testing.

Note 3: External components such as the catch diode, inductor, input and output capacitors can affect switching regulator system performance. When the LM2576/LM1576 is used as shown in *Figure 1* test circuit, system performance will be shown in system parameters section of Electrical Characteristics.

Note 4: Output (pin 2) sourcing current. No diode, inductor or capacitor connected to output.

Note 5: Feedback (pin 4) removed from output and connected to 0V.

Note 6: Feedback (pin 4) removed from output and connected to 12V to force the output transistor OFF.

Note 7: Junction to ambient thermal resistance (no external heat sink) for the 5-lead TO-220 package mounted vertically, with 1/2" leads in a socket, or on PC board with minimum copper area.

Note 8: Junction to ambient thermal resistance (no external heat sink) for the 5-lead TO-220 package mounted vertically, with 1/4" leads soldered to PC board containing approximately 4 square inches of copper area surrounding the leads.

Note 9: Junction to ambient thermal resistance with approximately 1 square inch of pc board copper surrounding the leads. Additional copper will lower thermal resistance further.

Typical Performance Characteristics

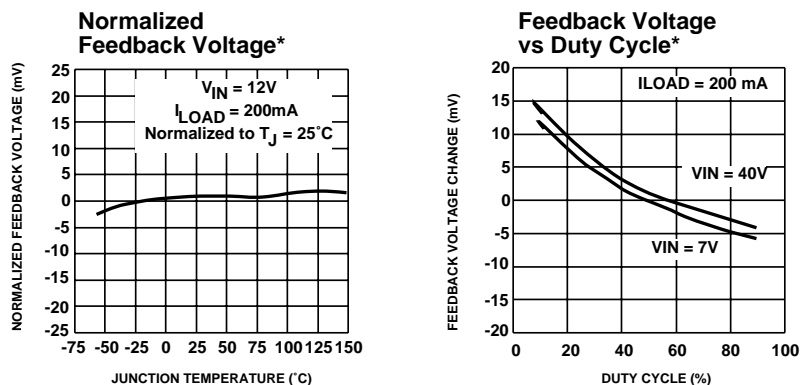

* Adjustable version only

Typical Performance Characteristics (continued) (Circuit of Figure 1)

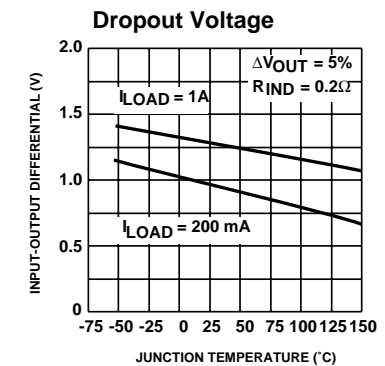
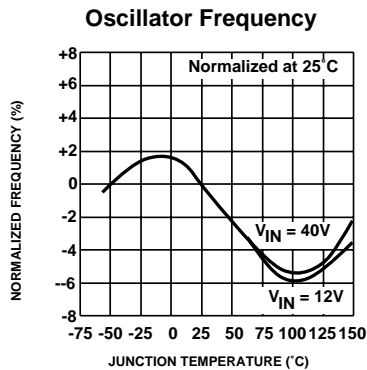
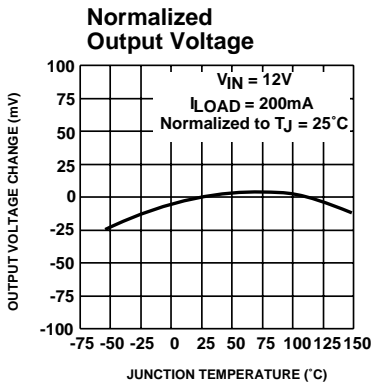
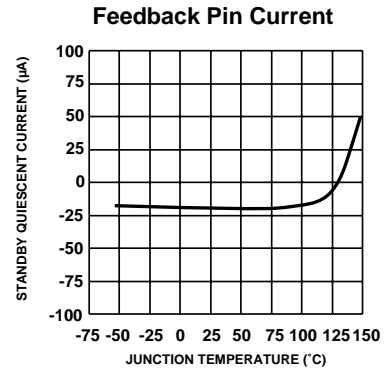
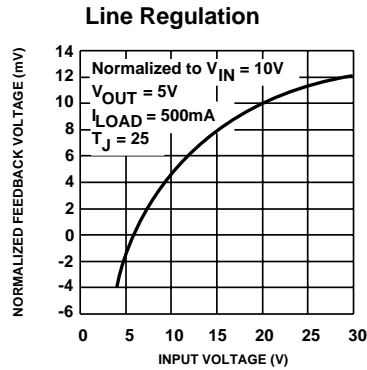
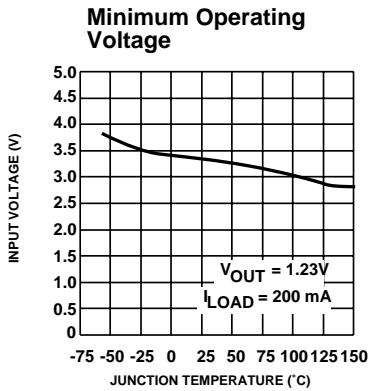
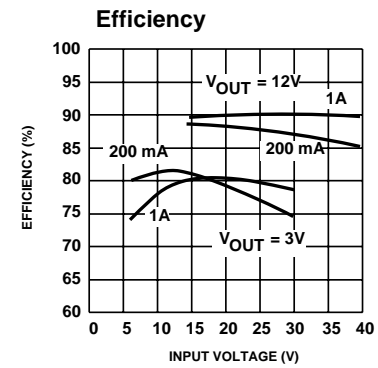
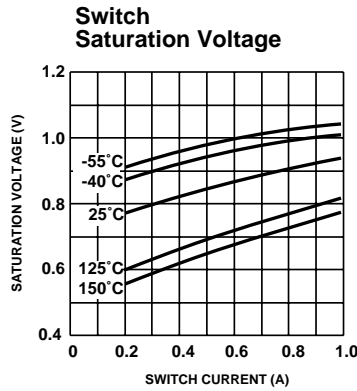
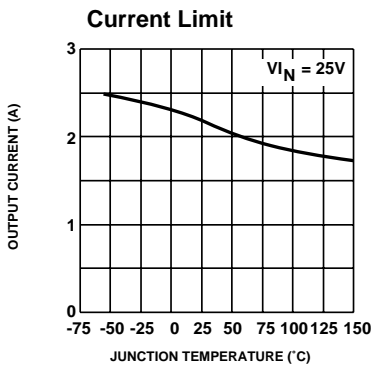
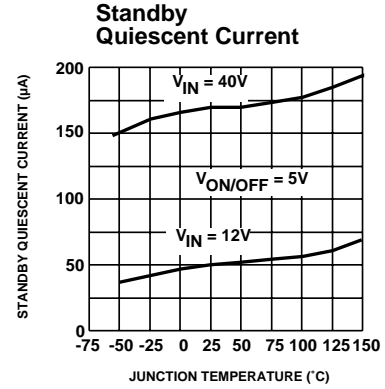
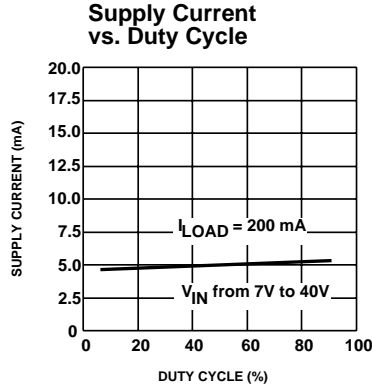
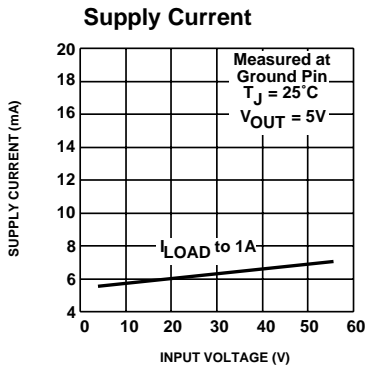

Typical Performance Characteristics (Circuit of Figure 1)

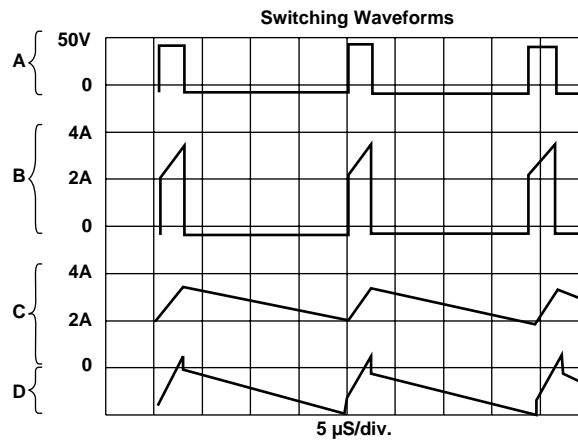
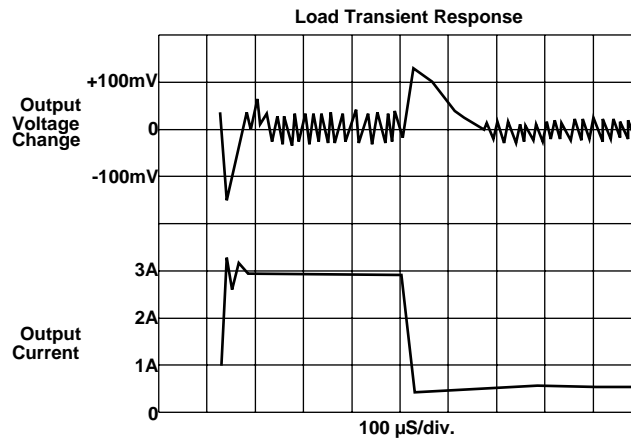

$$V_{OUT} = 5V \quad V_{IN} = 45V$$

- A: Output pin voltage 50V/div
- B: Output pin current 2A/div
- C: Inductor current 2A/div
- D: Output ripple voltage 50 mV/div., AC coupled

Horizontal Time Base: 5μS/div

Test Circuits and Layout Guidelines

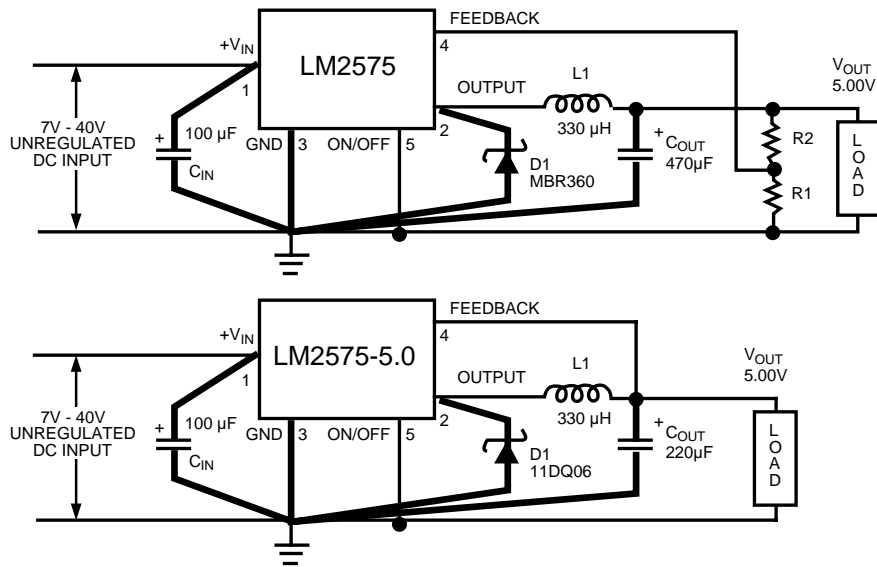

C_{IN} — 100µF, 75V Aluminum Electrolytic
 C_{OUT} — 470µF, 15V Aluminum Electrolytic
 D1 — Schottky, MBR360
 $L1$ — 330µH, 415-0926 (AIE)
 $R1$ — 1k, 0.01%
 $R2$ — 3.065k, 0.01%
 5-pin TO-220 socket—2936 (Loranger Mfg. Co.)
 4-pin TO-3 socket—8112-AG7 (Augat Inc.)

C_{IN} — 100µF, 75V Aluminum Electrolytic
 C_{OUT} — 330µF, 15V Aluminum Electrolytic
 D1 — Schottky, 11DQ06
 $L1$ — 100µH, 415-0926 (AIE)
 5-pin TO-220 socket—2936 (Loranger Mfg. Co.)
 4-pin TO-3 socket—8112-AG7 (Augat Inc.)

Note: Pin numbers are for TO-220 Package

Figure 1.

As in any switching regulator, layout is very important. Rapidly switching currents associated with wiring inductance generate voltage transients which can cause problems. For minimal stray inductance and ground loops, the length of the leads indicated by heavy lines should be kept as short as possible. Single-point grounding (as indicated) or ground plane construction should be used for best results.

Block Diagrams

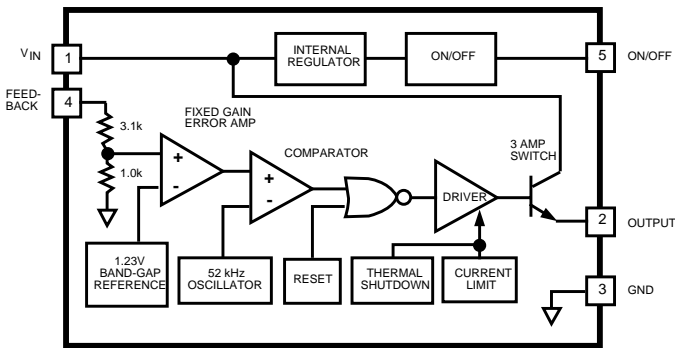

Note: Pin numbers are for the TO-220 package

Fixed Regulator

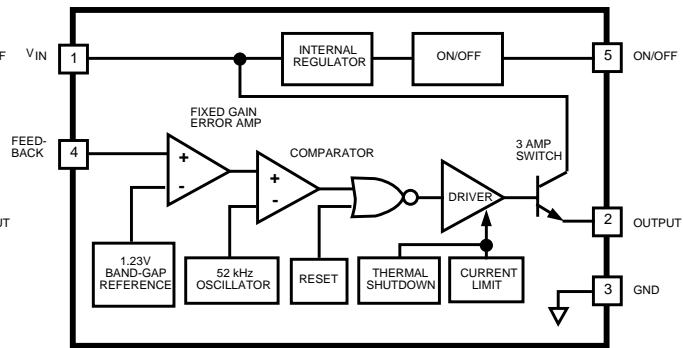

Adjustable Regulator

Package Information

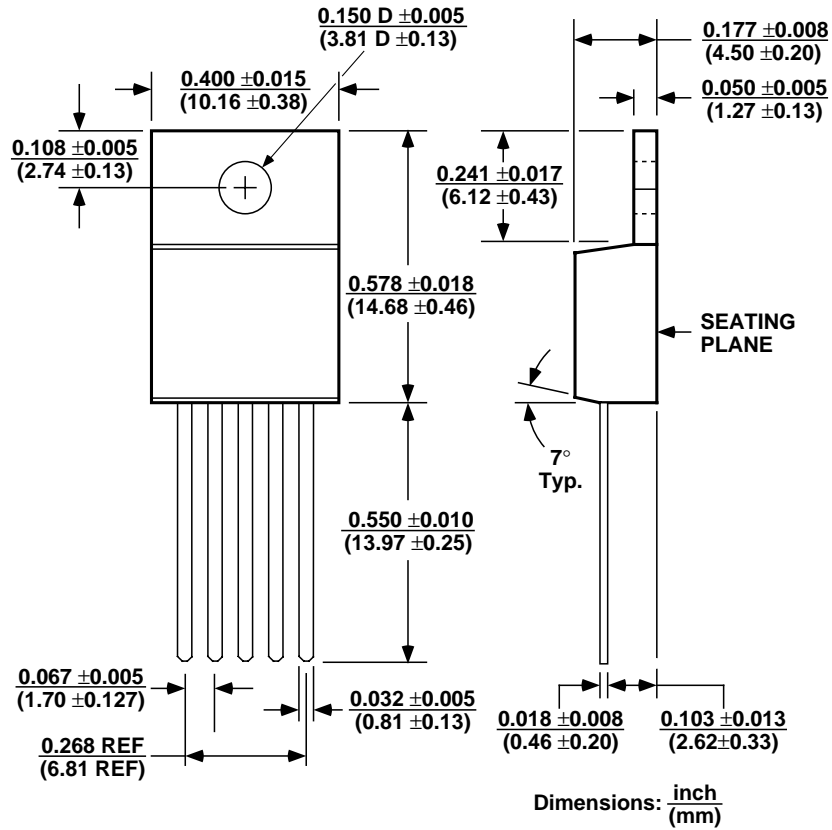

5-Lead TO-220 (T)

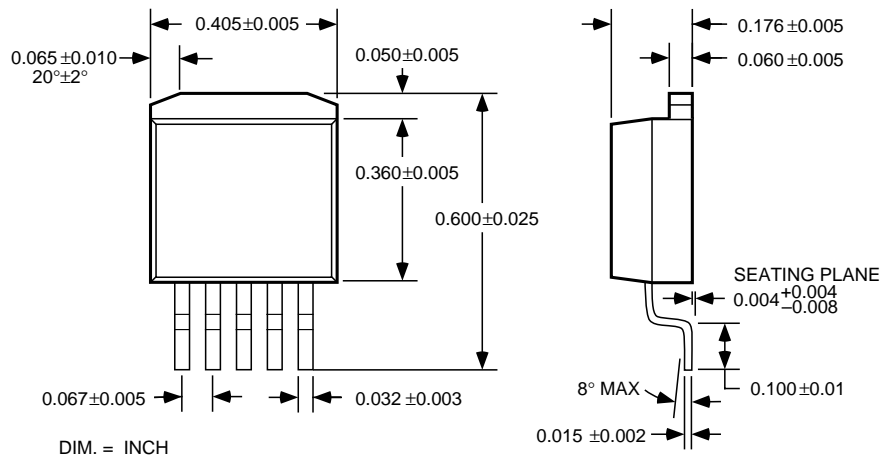

5-Lead TO-263 (U)

MICREL INC. 2180 FORTUNE DRIVE SAN JOSE, CA 95131 USA

TEL + 1 (408) 944-0800 FAX + 1 (408) 474-1000 WEB <http://www.micrel.com>

This information furnished by Micrel in this data sheet is believed to be accurate and reliable. However no responsibility is assumed by Micrel for its use. Micrel reserves the right to change circuitry and specifications at any time without notification to the customer.

Micrel Products are not designed or authorized for use as components in life support appliances, devices or systems where malfunction of a product can reasonably be expected to result in personal injury. Life support devices or systems are devices or systems that (a) are intended for surgical implant into the body or (b) support or sustain life, and whose failure to perform can be reasonably expected to result in a significant injury to the user. A Purchaser's use or sale of Micrel Products for use in life support appliances, devices or systems is a Purchaser's own risk and Purchaser agrees to fully indemnify Micrel for any damages resulting from such use or sale.

© 2005 Micrel, Incorporated.

Mouser Electronics

Authorized Distributor

Click to View Pricing, Inventory, Delivery & Lifecycle Information:

[Micrel:](#)

[LM2576-5.0WU](#) [LM2576WU](#) [LM2576WT](#) [LM2576-12WU](#) [LM2576-3.3WU](#) [LM2576-5.0WT](#) [LM2576WU TR](#)
[LM2576-12WT](#) [LM2576-3.3WT](#) [LM2576WU-TR](#) [LM2576-5.0WU-TR](#) [LM2576-3.3WU-TR](#) [LM2576-12WU-TR](#)