

Enhancement Mode pHEMT Technology (E-pHEMT) High Linearity Amplifier

The MMG20271H9 is a high dynamic range, single-stage, low noise amplifier MMIC, housed in a SOT-89 standard plastic package. With high OIP3 and low noise figure, it can be utilized as a driver amplifier in the transmit chain and as a second-stage LNA in the receive chain. It is ideal for cellular, PCS, LTE, TD-SCDMA, W-CDMA base station, wireless LAN and other systems in the 1500 to 2700 MHz frequency range.

Features

- Frequency: 1500-2700 MHz
- Noise Figure: 1.7 dB @ 2140 MHz
- P1dB: 27.5 dBm @ 2140 MHz
- Small-Signal Gain: 16 dB @ 2140 MHz
- Third Order Output Intercept Point: 43.1 dBm @ 2140 MHz
- Class 2 HBM ESD Immunity
- Single 5 V Supply
- Supply Current: 215 mA
- 50 Ohm Operation (some external matching required)
- Cost-effective SOT-89 Surface Mount Plastic Package
- In Tape and Reel. T1 Suffix = 1,000 Units, 12 mm Tape Width, 7-inch Reel.

MMG20271H9T1

**1500-2700 MHz, 16 dB
27.5 dBm
E-pHEMT LNA/GPA**



SOT-89

Table 1. Typical Performance (1)

Characteristic	Symbol	1500 MHz	1900 MHz	2140 MHz	2700 MHz	Unit
Noise Figure	NF	1.9	1.8	1.7	1.8	dB
Input Return Loss (S11)	IRL	-11	-12.1	-13.5	-18.5	dB
Output Return Loss (S22)	ORL	-24	-25.3	-35	-28	dB
Small-Signal Gain (S21)	G _p	18	16.6	16	14.3	dB
Power Output @ 1dB Compression	P1dB	27.5	27.5	27.5	27.6	dBm
Third Order Input Intercept Point	IIP3	23	25.2	27.1	29.9	dBm
Third Order Output Intercept Point	OIP3	41	41.8	43.1	44.2	dBm

1. V_{DD} = 5 Vdc, T_A = 25°C, 50 ohm system, application circuit tuned for specified frequency.

Table 2. Maximum Ratings

Rating	Symbol	Value	Unit
Supply Voltage	V _{DD}	6	V
Supply Current	I _{DD}	400	mA
RF Input Power	P _{in}	25	dBm
Storage Temperature Range	T _{stg}	-65 to +150	°C
Junction Temperature	T _J	175	°C

Table 3. Thermal Characteristics

Characteristic	Symbol	Value (2)	Unit
Thermal Resistance, Junction to Case Case Temperature 91°C, 5 Vdc, 220 mA, no RF applied	R _{θJC}	29	°C/W

2. Refer to AN1955, *Thermal Measurement Methodology of RF Power Amplifiers*. Go to <http://www.freescale.com/rf>. Select Documentation/Application Notes - AN1955.

Table 4. Electrical Characteristics ($V_{DD} = 5$ Vdc, 2140 MHz, $T_A = 25^\circ\text{C}$, 50 ohm system, in Freescale Application Circuit)

Characteristic	Symbol	Min	Typ	Max	Unit
Small-Signal Gain (S21)	G_p	13.4	16	—	dB
Input Return Loss (S11)	IRL	—	-13.5	—	dB
Output Return Loss (S22)	ORL	—	-35	—	dB
Power Output @ 1dB Compression	P1dB	—	27.5	—	dBm
Third Order Input Intercept Point	IIP3	—	27.1	—	dBm
Third Order Output Intercept Point	OIP3	—	43.1	—	dBm
Reverse Isolation (S12)	S12	—	-22	—	dB
Noise Figure	NF	—	1.7	—	dB
Supply Current	I_{DD}	177	215	271	mA
Supply Voltage	V_{DD}	—	5	—	V

Table 5. ESD Protection Characteristics

Test Methodology	Class
Human Body Model (per JESD22-A114)	2
Machine Model (per EIA/JESD22-A115)	A
Charge Device Model (per JESD22-C101)	IV

Table 6. Moisture Sensitivity Level

Test Methodology	Rating	Package Peak Temperature	Unit
Per JESD22-A113, IPC/JEDEC J-STD-020	1	260	$^\circ\text{C}$

Table 7. Functional Pin Description

Pin Number	Pin Function
1	RF_{in}
2	Ground
3	RF_{out}/DC Supply

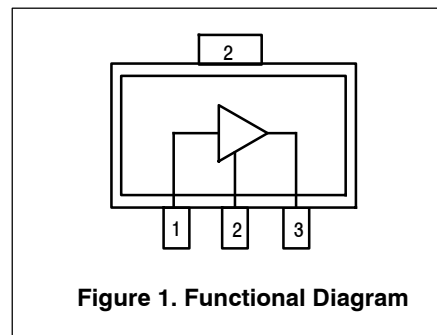

50 OHM APPLICATION CIRCUIT: 2140 MHz

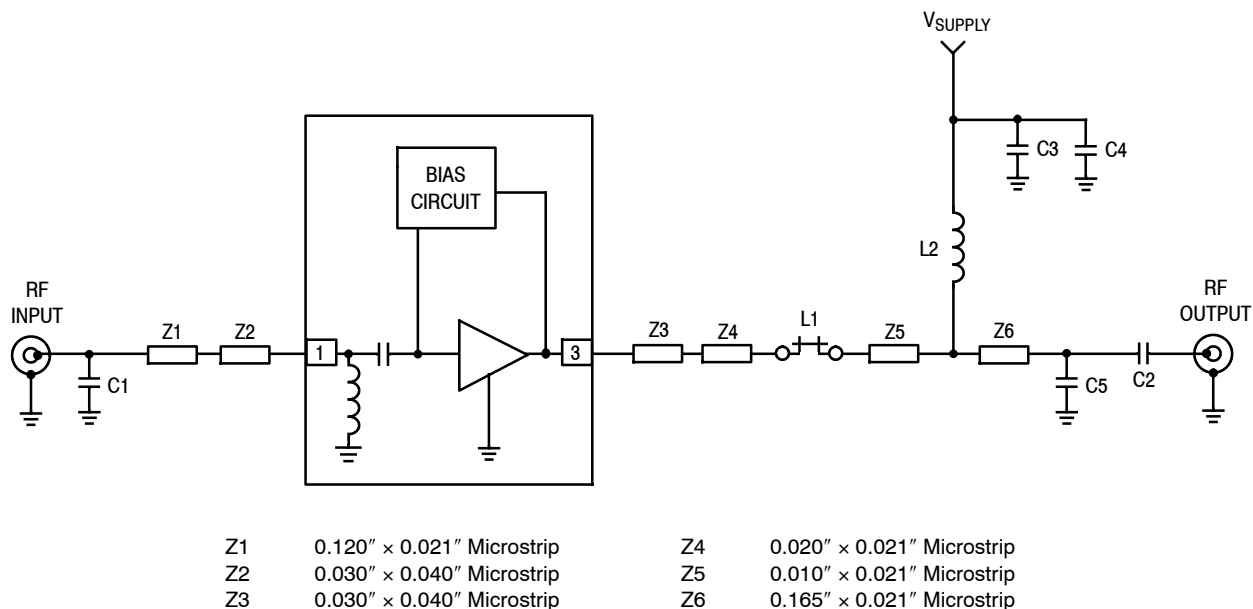

Figure 2. MMG20271H9T1 Test Circuit Schematic

Table 8. MMG20271H9T1 Test Circuit Component Designations and Values

Part	Description	Part Number	Manufacturer
C1	1.5 pF Chip Capacitor	GRM1555C1H1R5BA01	Murata
C2, C3	18 pF Chip Capacitors	GRM1555C1H180GA01	Murata
C4	0.1 μF Chip Capacitor	GRM155R61A104K01D	Murata
C5	1.2 pF Chip Capacitor	GRM1555C1H1R2BA01	Murata
L1 (1)	0 Ω, 1 A Chip Resistor	ERJ2GE0R00X	Panasonic
L2	23 nH Inductor	0402CS-23NXGL	Coilcraft
PCB	0.010", ε _r = 3.48, Multilayer	RO4350B	Rogers

1. Location L1 can be an inductor, resistor or jumper depending on frequency.

50 OHM APPLICATION CIRCUIT: 2140 MHz

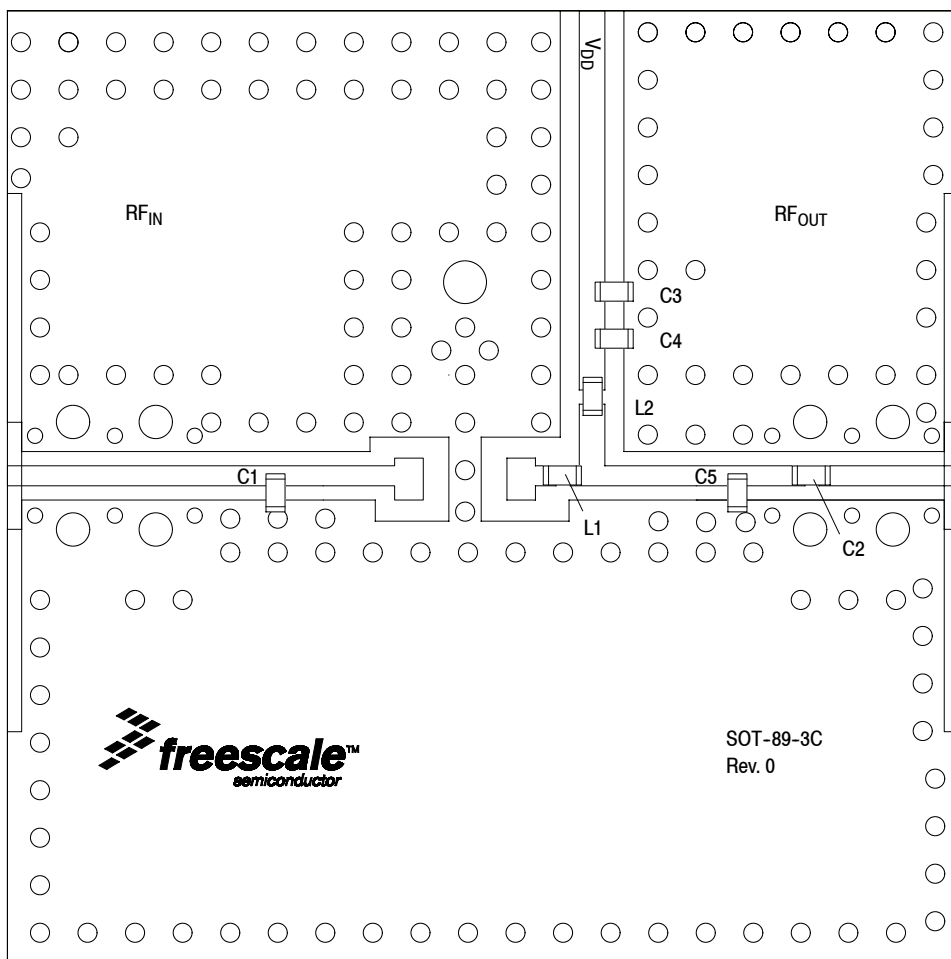

Figure 3. MMG20271H9T1 Test Circuit Component Layout

Table 8. MMG20271H9T1 Test Circuit Component Designations and Values

Part	Description	Part Number	Manufacturer
C1	1.5 pF Chip Capacitor	GRM1555C1H1R5BA01	Murata
C2, C3	18 pF Chip Capacitors	GRM1555C1H180GA01	Murata
C4	0.1 μ F Chip Capacitor	GRM155R61A104K01D	Murata
C5	1.2 pF Chip Capacitor	GRM1555C1H1R2BA01	Murata
L1 (1)	0 Ω , 1 A Chip Resistor	ERJ2GE0R00X	Panasonic
L2	23 nH Inductor	0402CS-23NXGL	Coilcraft
PCB	0.010", $\epsilon_r = 3.48$, Multilayer	RO4350B	Rogers

1. Location L1 can be an inductor, resistor or jumper depending on frequency.
 (Test Circuit Component Designations and Values table repeated for reference.)

50 OHM TYPICAL CHARACTERISTICS: 2140 MHz

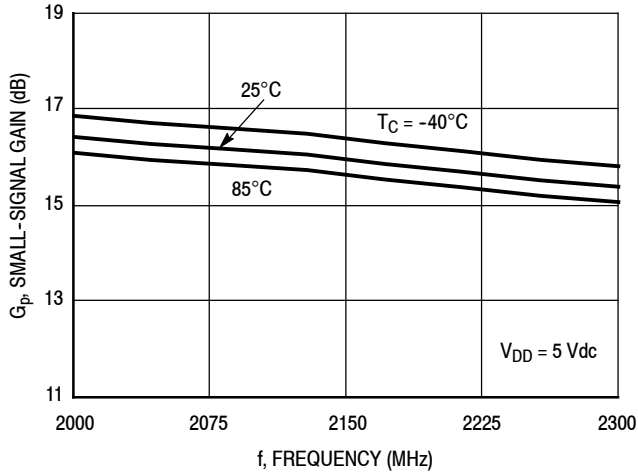

Figure 4. Small-Signal Gain (S21) versus Frequency versus Temperature

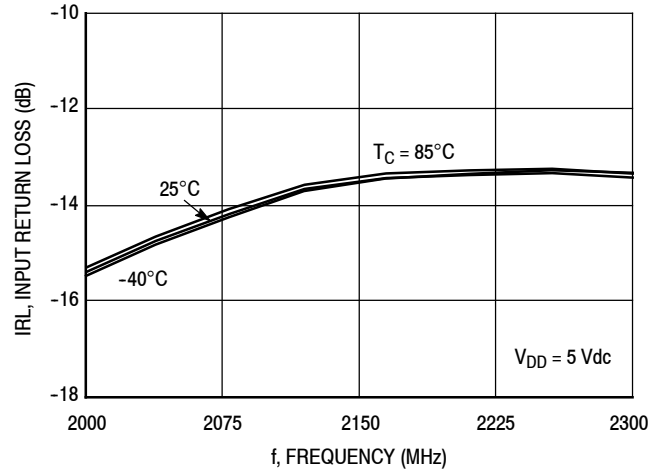

Figure 5. Input Return Loss (S11) versus Frequency versus Temperature

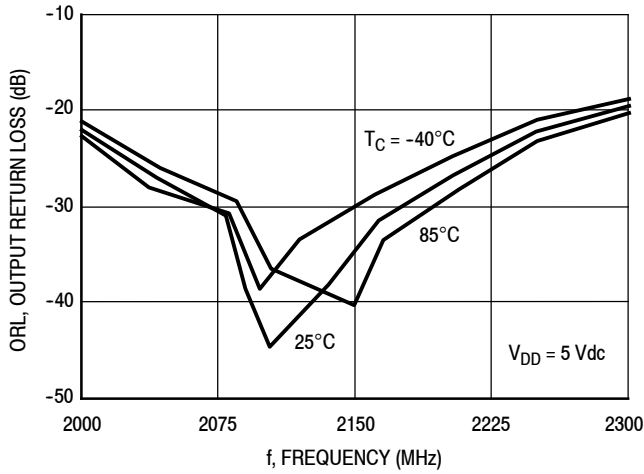

Figure 6. Output Return Loss (S22) versus Frequency versus Temperature

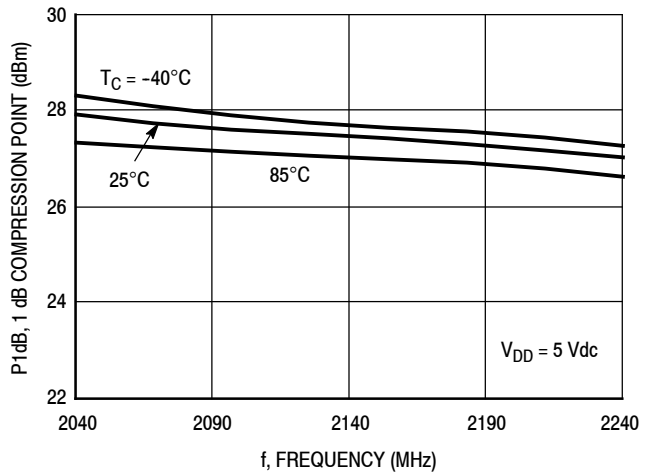

Figure 7. P1dB versus Frequency versus Temperature

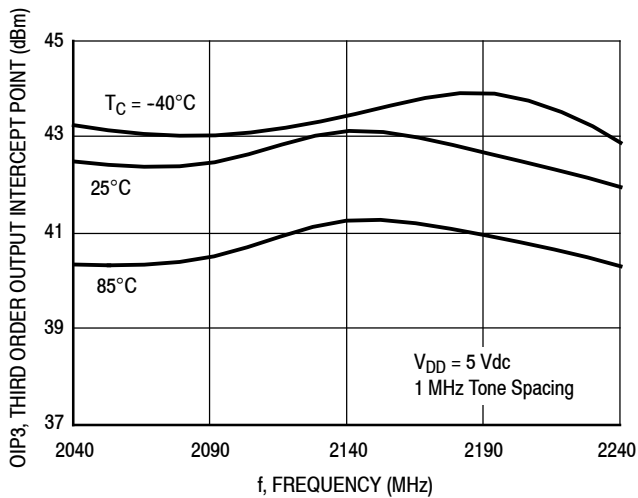

Figure 8. Third Order Output Intercept Point versus Frequency versus Temperature

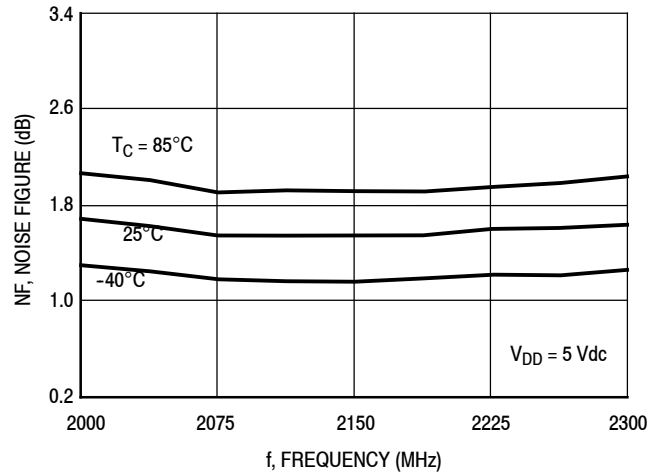

Figure 9. Noise Figure versus Frequency versus Temperature

50 OHM TYPICAL CHARACTERISTICS: 2140 MHz

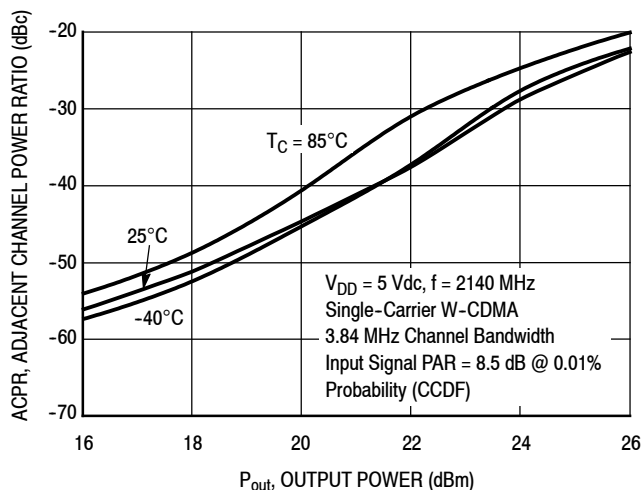

Figure 10. Single-Carrier W-CDMA Adjacent Channel Power Ratio versus Output Power

50 OHM APPLICATION CIRCUIT: 1900 MHz

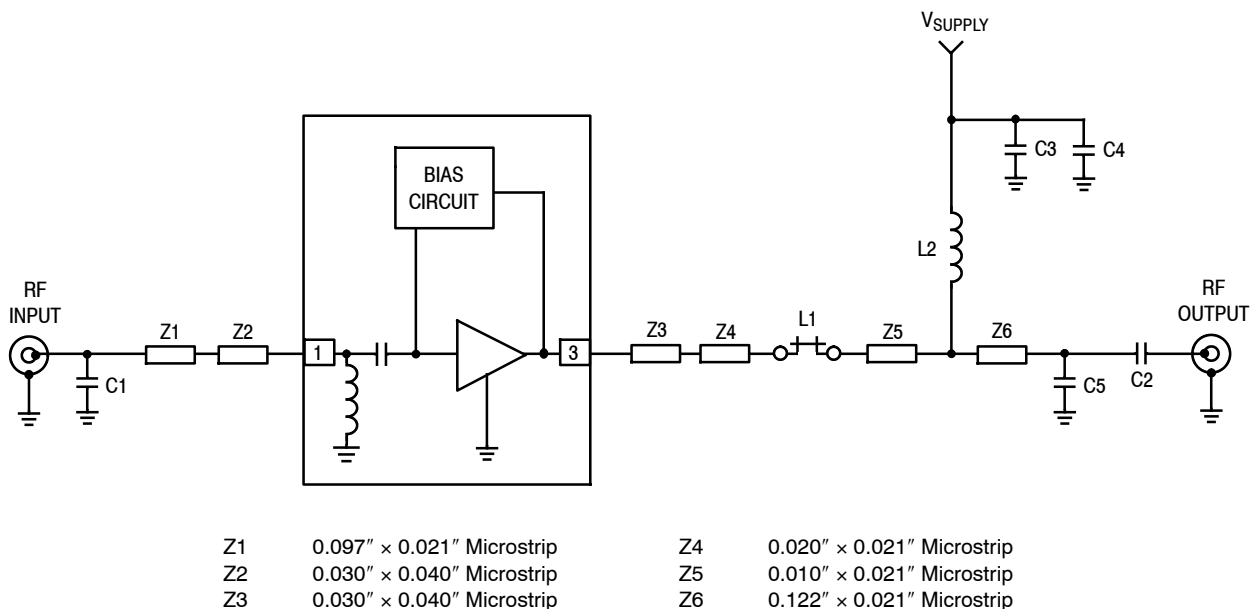

Figure 11. MMG20271H9T1 Test Circuit Schematic

Table 9. MMG20271H9T1 Test Circuit Component Designations and Values

Part	Description	Part Number	Manufacturer
C1	1.8 pF Chip Capacitor	GRM1555C1H1R8BA01	Murata
C2, C3	18 pF Chip Capacitors	GRM1555C1H180GA01	Murata
C4	0.1 μF Chip Capacitor	GRM155R61A104K01D	Murata
C5	1.5 pF Chip Capacitor	GRM1555C1H1R5BA01	Murata
L1 (1)	1.2 nH Inductor	0402CS-1N2XJL	Coilcraft
L2	23 nH Inductor	0402CS-23NXGL	Coilcraft
PCB	0.010", ε _r = 3.48, Multilayer	RO4350B	Rogers

1. Location L1 can be an inductor, resistor or jumper depending on frequency.

50 OHM APPLICATION CIRCUIT: 1900 MHz

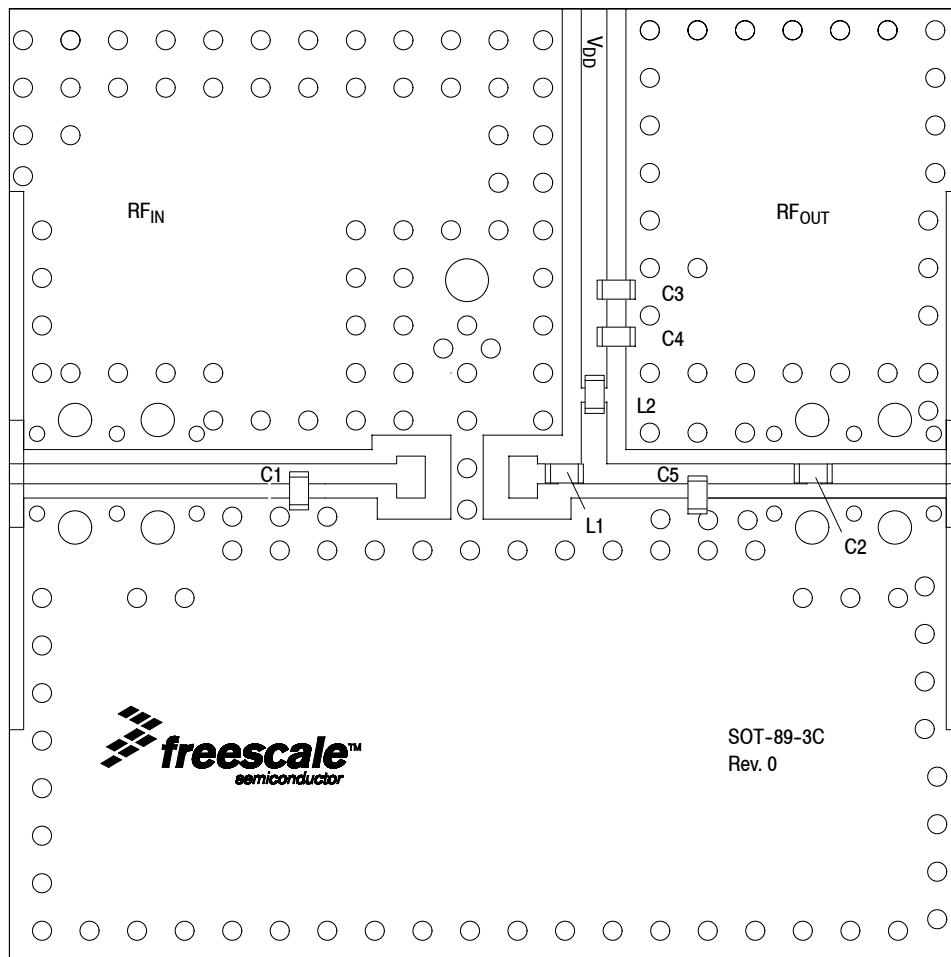

Figure 12. MMG20271H9T1 Test Circuit Component Layout

Table 9. MMG20271H9T1 Test Circuit Component Designations and Values

Part	Description	Part Number	Manufacturer
C1	1.8 pF Chip Capacitor	GRM1555C1H1R8BA01	Murata
C2, C3	18 pF Chip Capacitors	GRM1555C1H180GA01	Murata
C4	0.1 μ F Chip Capacitor	GRM155R61A104K01D	Murata
C5	1.5 pF Chip Capacitor	GRM1555C1H1R5BA01	Murata
L1 (1)	1.2 nH Inductor	0402CS-1N2XJL	Coilcraft
L2	23 nH Inductor	0402CS-23NXGL	Coilcraft
PCB	0.010", $\epsilon_r = 3.48$, Multilayer	RO4350B	Rogers

1. Location L1 can be an inductor, resistor or jumper depending on frequency.
 (Test Circuit Component Designations and Values table repeated for reference.)

50 OHM TYPICAL CHARACTERISTICS: 1900 MHz

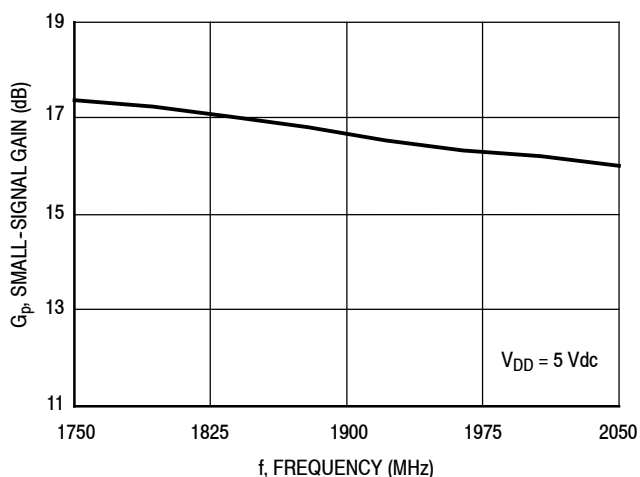

Figure 13. Small-Signal Gain (S21) versus Frequency

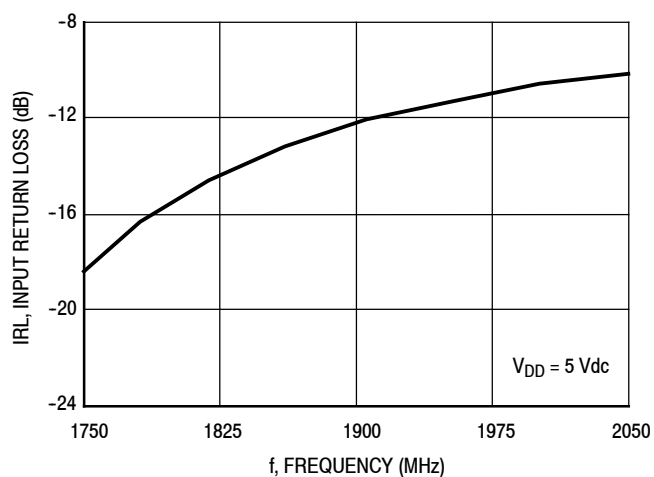

Figure 14. Input Return Loss (S11) versus Frequency

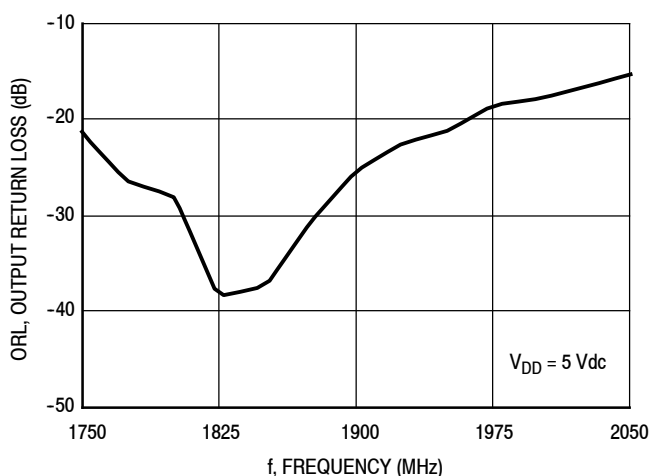

Figure 15. Output Return Loss (S22) versus Frequency

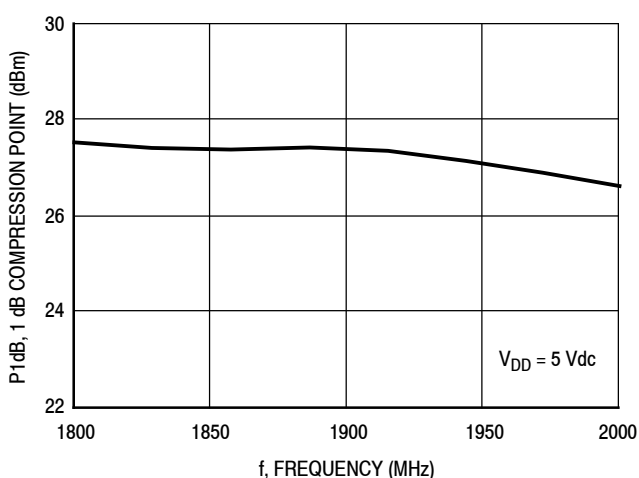

Figure 16. P1dB versus Frequency

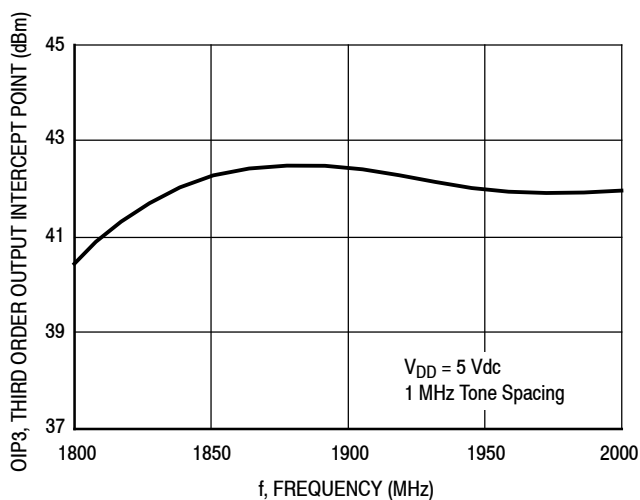

Figure 17. Third Order Output Intercept Point versus Frequency

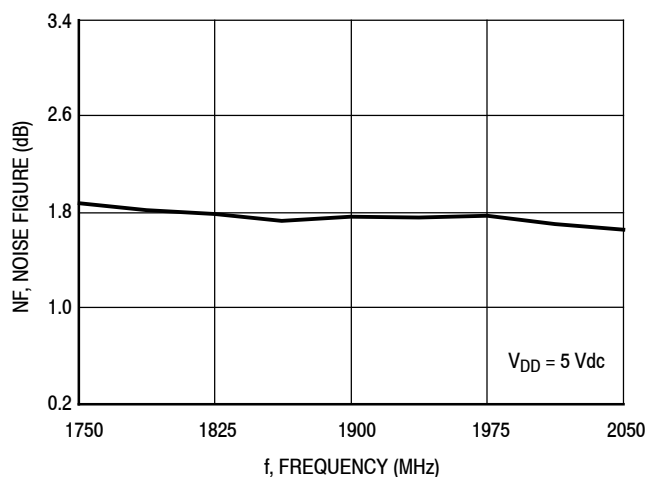
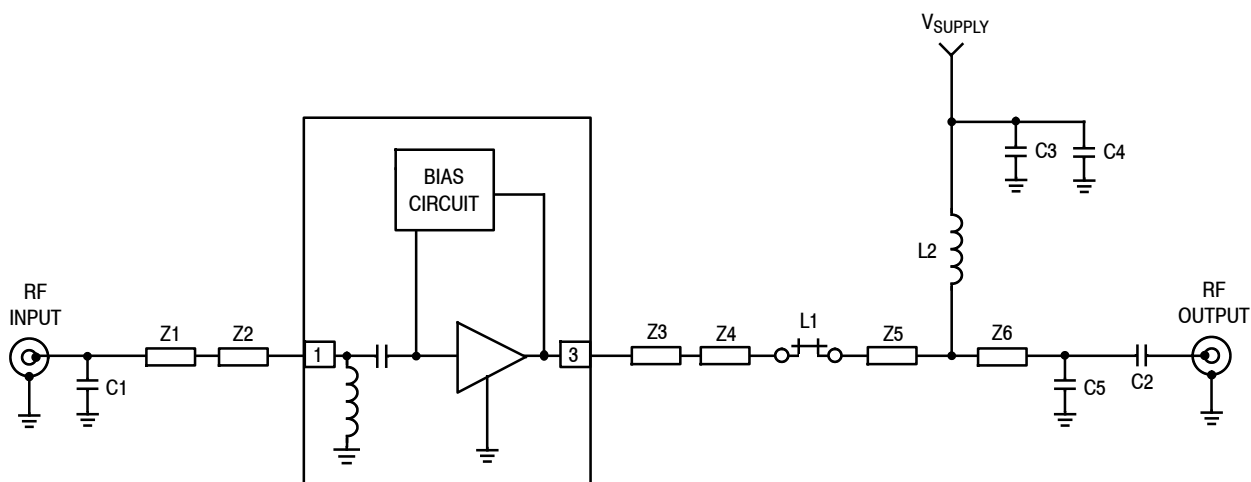

Figure 18. Noise Figure versus Frequency

50 OHM APPLICATION CIRCUIT: 2700 MHz



Z1	0.080" × 0.021" Microstrip	Z4	0.020" × 0.021" Microstrip
Z2	0.030" × 0.040" Microstrip	Z5	0.010" × 0.021" Microstrip
Z3	0.030" × 0.040" Microstrip	Z6	0.048" × 0.021" Microstrip

Figure 19. MMG20271H9T1 Test Circuit Schematic

Table 10. MMG20271H9T1 Test Circuit Component Designations and Values

Part	Description	Part Number	Manufacturer
C1	1.5 pF Chip Capacitor	GRM1555C1H1R5BA01	Murata
C2, C3	18 pF Chip Capacitors	GRM1555C1H180GA01	Murata
C4	0.1 μF Chip Capacitor	GRM155R61A104K01D	Murata
C5	1.0 pF Chip Capacitor	GRM1555C1H1R0BA01	Murata
L1 (1)	0 Ω, 1 A Chip Resistor	ERJ2GE0R00X	Panasonic
L2	23 nH Inductor	0402CS-23NXGL	Coilcraft
PCB	0.010", ε _r = 3.48, Multilayer	RO4350B	Rogers

1. Location L1 can be an inductor, resistor or jumper depending on frequency.

50 OHM APPLICATION CIRCUIT: 2700 MHz

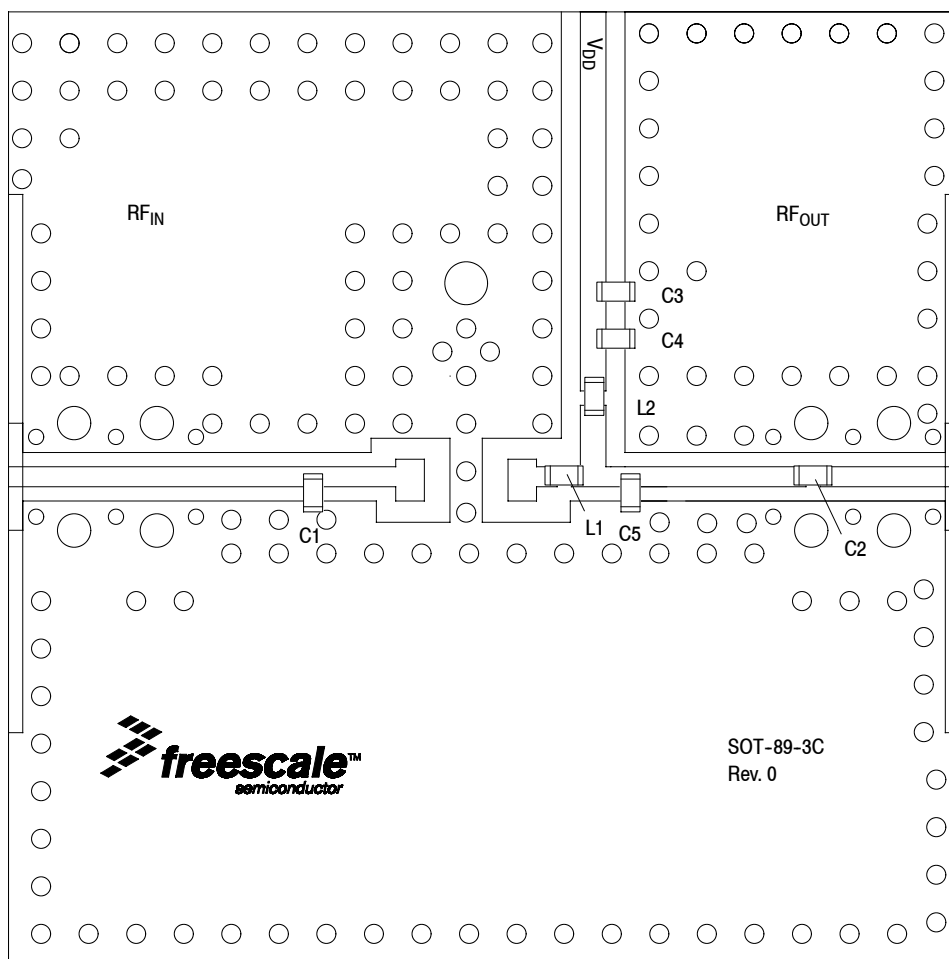

Figure 20. MMG20271H9T1 Test Circuit Component Layout

Table 10. MMG20271H9T1 Test Circuit Component Designations and Values

Part	Description	Part Number	Manufacturer
C1	1.5 pF Chip Capacitor	GRM1555C1H1R5BA01	Murata
C2, C3	18 pF Chip Capacitors	GRM1555C1H180GA01	Murata
C4	0.1 μ F Chip Capacitor	GRM155R61A104K01D	Murata
C5	1.0 pF Chip Capacitor	GRM1555C1H1R0BA01	Murata
L1 (1)	0 Ω , 1 A Chip Resistor	ERJ2GE0R00X	Panasonic
L2	23 nH Inductor	0402CS-23NXGL	Coilcraft
PCB	0.010", $\epsilon_r = 3.48$, Multilayer	RO4350B	Rogers

1. Location L1 can be an inductor, resistor or jumper depending on frequency.
 (Test Circuit Component Designations and Values table repeated for reference.)

50 OHM TYPICAL CHARACTERISTICS: 2700 MHz

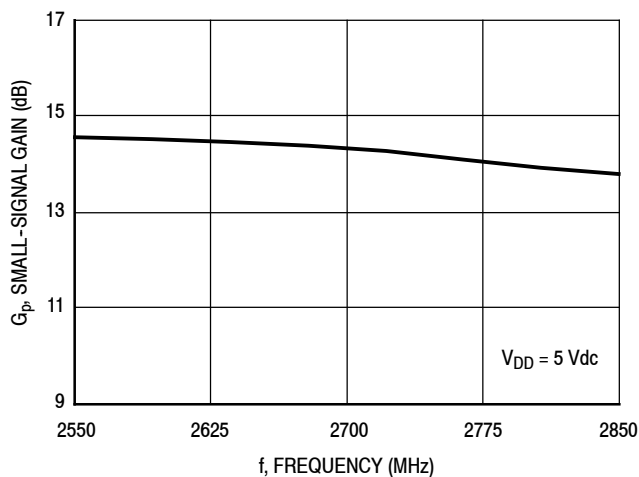

Figure 21. Small-Signal Gain (S21) versus Frequency

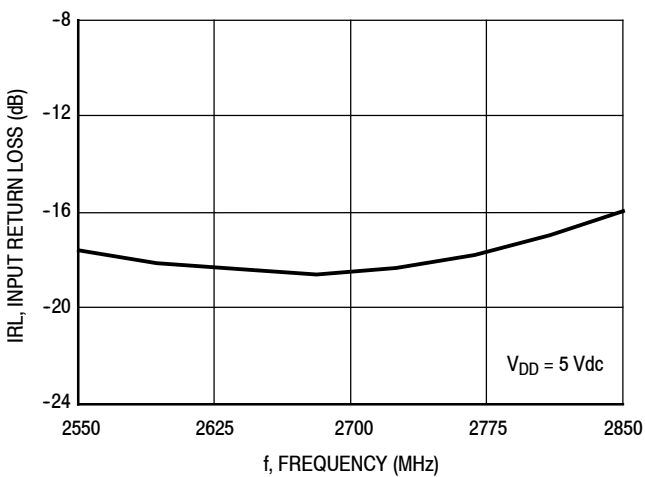

Figure 22. Input Return Loss (S11) versus Frequency

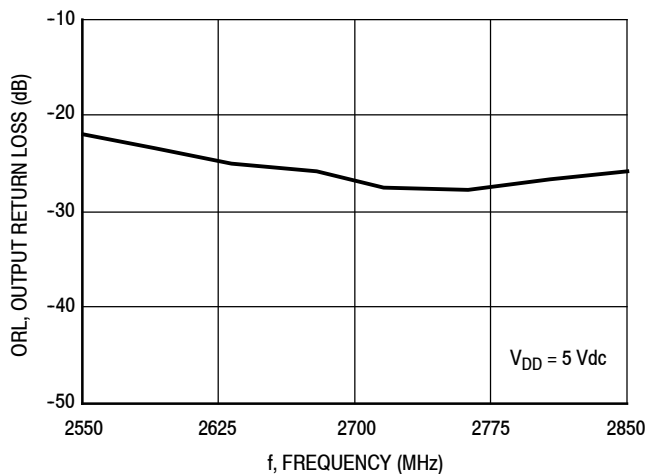

Figure 23. Output Return Loss (S22) versus Frequency

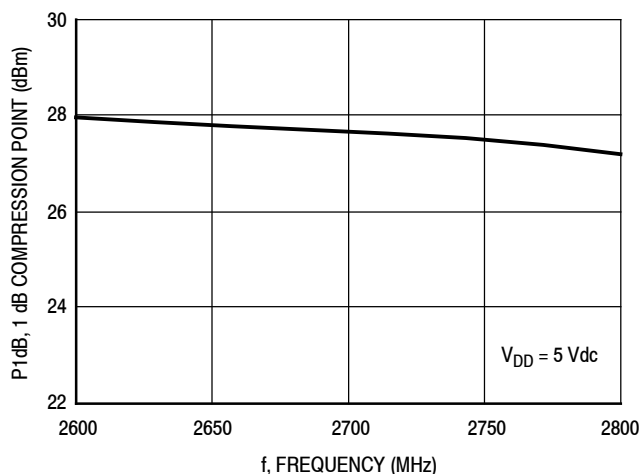

Figure 24. P1dB versus Frequency

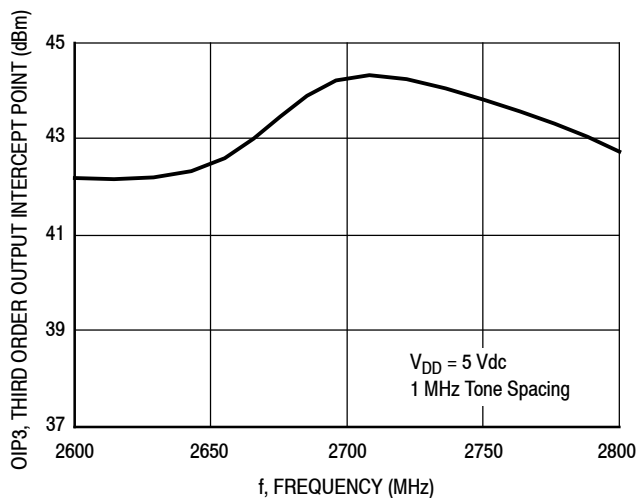

Figure 25. Third Order Output Intercept Point versus Frequency

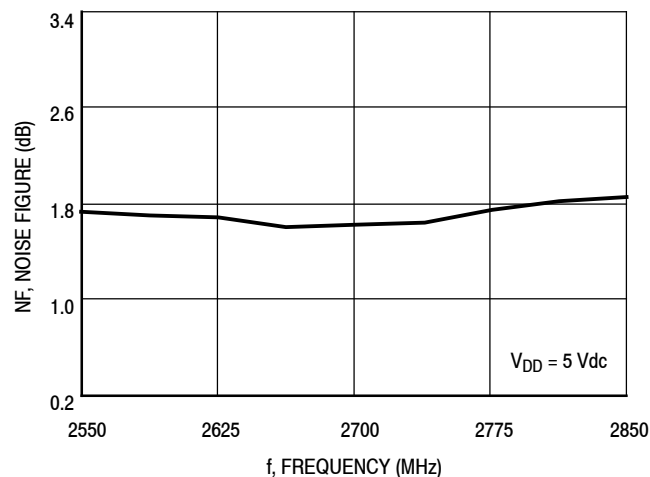

Figure 26. Noise Figure versus Frequency

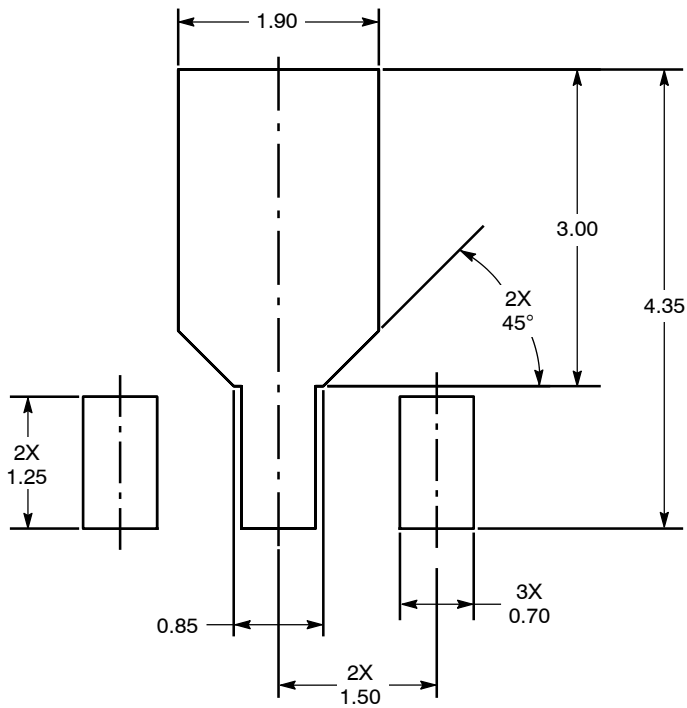
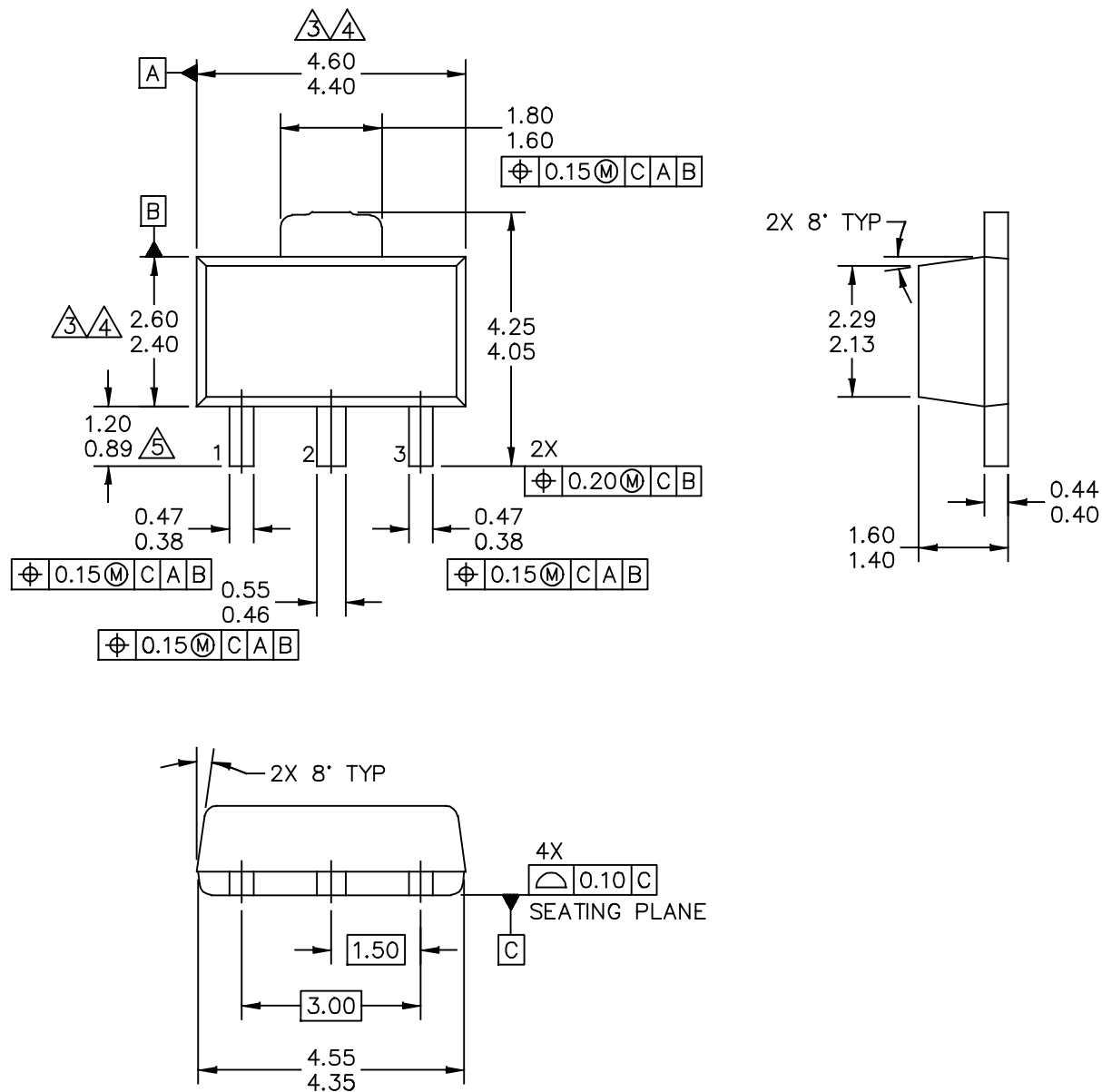

Figure 27. PCB Pad Layout for SOT-89A

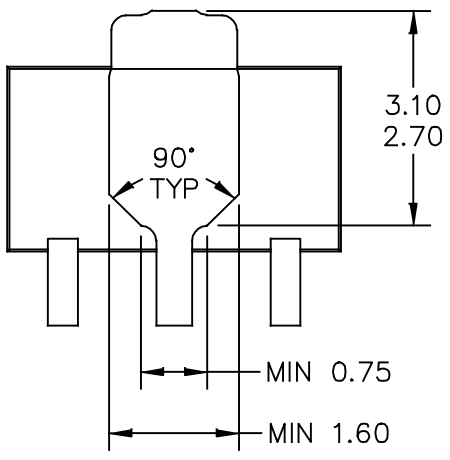

Figure 28. Product Marking

PACKAGE DIMENSIONS



© FREESCALE SEMICONDUCTOR, INC. ALL RIGHTS RESERVED.		MECHANICAL OUTLINE		PRINT VERSION NOT TO SCALE	
TITLE: SOT-89A, 3 LEAD, 4.5 X 2.5 PKG, 1.5 MM PITCH			DOCUMENT NO: 98ASA00241D		REV: 0
			CASE NUMBER: 2142-01		15 JUL 2010
			STANDARD: NON-JEDEC		



BOTTOM VIEW

© FREESCALE SEMICONDUCTOR, INC. ALL RIGHTS RESERVED.	MECHANICAL OUTLINE	PRINT VERSION NOT TO SCALE	
TITLE: SOT-89A, 3 LEAD, 4.5 X 2.5 PKG, 1.5 MM PITCH	DOCUMENT NO: 98ASA00241D	REV: 0	
	CASE NUMBER: 2142-01	15 JUL 2010	
	STANDARD: NON-JEDEC		

NOTES:

1. DIMENSIONING AND TOLERANCING PER ASME Y14.5M – 1994.

2. ALL DIMENSIONS ARE IN MILLIMETERS.

3. DIMENSIONS DOES NOT INCLUDE MOLD FLASH. PROTRUSIONS OR GATE BURRS. MOLD FLASH, PROTRUSIONS OR GATE BURRS SHALL NOT EXCEED 0.5 MM PER END. DIMENSION DOES NOT INCLUDE INTERLEAD FLASH OR PROTRUSION. INTERLEAD FLASH OR PROTRUSION SHALL NOT EXCEED 0.5 MM PER SIDE.

4. DIMENSION ARE DETERMINED AT THE OUTMOST EXTREMES OF THE PLASTIC BODY EXCLUSIVE OF MOLD FLASH, TIE BAR BURRS, GATE BURRS AND INTERLEAD FLASH, BUT INCLUDING ANY MISMATCH BETWEEN THE TOP AND BOTTOM OF THE PLASTIC BODY.

5. TERMINAL NUMBERS ARE SHOWN FOR REFERENCE ONLY.

© FREESCALE SEMICONDUCTOR, INC. ALL RIGHTS RESERVED.	MECHANICAL OUTLINE	PRINT VERSION NOT TO SCALE	
TITLE: SOT-89A, 3 LEAD, 4.5 X 2.5 PKG, 1.5 MM PITCH	DOCUMENT NO: 98ASA00241D	REV: 0	
	CASE NUMBER: 2142-01	15 JUL 2010	
	STANDARD: NON-JEDEC		

Refer to the following resources to aid your design process.

Application Notes

- AN1955: Thermal Measurement Methodology of RF Power Amplifiers
- AN3100: General Purpose Amplifier and MMIC Biasing

Software

- .s2p File

Development Tools

- Printed Circuit Boards

For Software and Tools, do a Part Number search at <http://www.freescale.com>, and select the “Part Number” link. Go to Software & Tools on the part’s Product Summary page to download the respective tool.

FAILURE ANALYSIS

At this time, because of the physical characteristics of the part, failure analysis is limited to electrical signature analysis. In cases where Freescale is contractually obligated to perform failure analysis (FA) services, full FA may be performed by third party vendors with moderate success. For updates contact your local Freescale Sales Office.

REVISION HISTORY

The following table summarizes revisions to this document.

Revision	Date	Description
0	Dec. 2011	<ul style="list-style-type: none"> • Initial Release of Data Sheet
1	Sept. 2014	<ul style="list-style-type: none"> • Table 2, Maximum Ratings: updated Junction Temperature from 150°C to 175°C to reflect recent test results of the device, p. 1 • Revised Failure Analysis information, p. 17

How to Reach Us:

Home Page:
freescale.com

Web Support:
freescale.com/support

Information in this document is provided solely to enable system and software implementers to use Freescale products. There are no express or implied copyright licenses granted hereunder to design or fabricate any integrated circuits based on the information in this document.

Freescale reserves the right to make changes without further notice to any products herein. Freescale makes no warranty, representation, or guarantee regarding the suitability of its products for any particular purpose, nor does Freescale assume any liability arising out of the application or use of any product or circuit, and specifically disclaims any and all liability, including without limitation consequential or incidental damages. "Typical" parameters that may be provided in Freescale data sheets and/or specifications can and do vary in different applications, and actual performance may vary over time. All operating parameters, including "typicals," must be validated for each customer application by customer's technical experts. Freescale does not convey any license under its patent rights nor the rights of others. Freescale sells products pursuant to standard terms and conditions of sale, which can be found at the following address: freescale.com/SalesTermsandConditions.

Freescale and the Freescale logo are trademarks of Freescale Semiconductor, Inc., Reg. U.S. Pat. & Tm. Off. All other product or service names are the property of their respective owners.

© 2011, 2014 Freescale Semiconductor, Inc.

Mouser Electronics

Authorized Distributor

Click to View Pricing, Inventory, Delivery & Lifecycle Information:

[Freescale Semiconductor:](#)

[MMG20271H9T1](#)