

RF Power Field Effect Transistors

N-Channel Enhancement-Mode Lateral MOSFETs

Designed primarily for pulse wideband applications with frequencies up to 150 MHz. Devices are unmatched and are suitable for use in industrial, medical and scientific applications.

- Typical Pulse Performance at 130 MHz: $V_{DD} = 50$ Volts, $I_{DQ} = 150$ mA, $P_{out} = 1000$ Watts Peak (200 W Avg.), Pulse Width = 100 μ sec, Duty Cycle = 20%
 Power Gain — 26 dB
 Drain Efficiency — 71%
- Capable of Handling 10:1 VSWR, @ 50 Vdc, 130 MHz, 1000 Watts Peak Power

Features

- Characterized with Series Equivalent Large-Signal Impedance Parameters
- CW Operation Capability with Adequate Cooling
- Qualified Up to a Maximum of 50 V_{DD} Operation
- Integrated ESD Protection
- Designed for Push-Pull Operation
- Greater Negative Gate-Source Voltage Range for Improved Class C Operation
- In Tape and Reel. R6 Suffix = 150 Units, 56 mm Tape Width, 13 inch Reel.
 R5 Suffix = 50 Units, 56 mm Tape Width, 13 Inch Reel.

MRF6VP11KHR6
MRF6VP11KGSR5

1.8-150 MHz, 1000 W, 50 V
LATERAL N-CHANNEL
BROADBAND
RF POWER MOSFETs

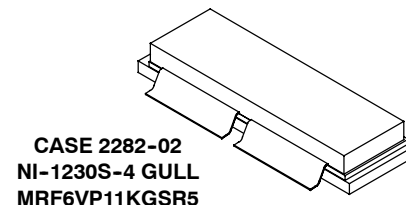
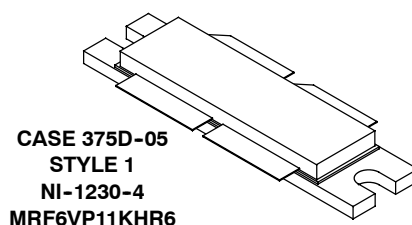

PARTS ARE PUSH-PULL

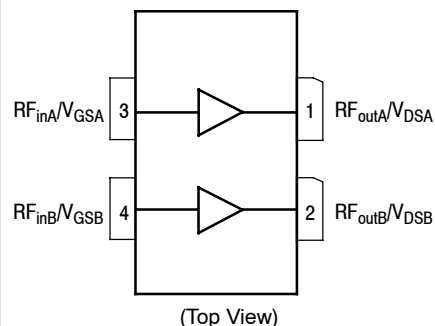

Figure 1. Pin Connections

Table 1. Maximum Ratings

Rating	Symbol	Value	Unit
Drain-Source Voltage	V_{DSS}	-0.5, +110	Vdc
Gate-Source Voltage	V_{GS}	-6.0, +10	Vdc
Storage Temperature Range	T_{stg}	-65 to +150	$^{\circ}$ C
Case Operating Temperature	T_C	150	$^{\circ}$ C
Operating Junction Temperature (1,2)	T_J	225	$^{\circ}$ C

Table 2. Thermal Characteristics

Characteristic	Symbol	Value (2,3)	Unit
Thermal Resistance, Junction to Case CW: Case Temperature 67 $^{\circ}$ C, 1000 W CW, 100 MHz	$R_{\theta JC}$	0.13	$^{\circ}$ C/W
Thermal Impedance, Junction to Case Pulse: Case Temperature 80 $^{\circ}$ C, 1000 W Peak, 100 μ sec Pulse Width, 20% Duty Cycle	$Z_{\theta JC}$	0.03	$^{\circ}$ C/W

1. Continuous use at maximum temperature will affect MTTF.
2. MTTF calculator available at <http://www.freescale.com/rf>. Select Software & Tools/Development Tools/Calculators to access MTTF calculators by product.
3. Refer to AN1955, *Thermal Measurement Methodology of RF Power Amplifiers*. Go to <http://www.freescale.com/rf>. Select Documentation/Application Notes - AN1955.

Table 3. ESD Protection Characteristics

Test Methodology	Class
Human Body Model (per JESD22-A114)	2, passes 2000 V
Machine Model (per EIA/JESD22-A115)	A, passes 125 V
Charge Device Model (per JESD22-C101)	IV, passes 2000 V

Table 4. Electrical Characteristics ($T_A = 25^\circ\text{C}$ unless otherwise noted)

Characteristic	Symbol	Min	Typ	Max	Unit
----------------	--------	-----	-----	-----	------

Off Characteristics (1)

Gate-Source Leakage Current ($V_{GS} = 5\text{ Vdc}$, $V_{DS} = 0\text{ Vdc}$)	I_{GSS}	—	—	10	μA
Drain-Source Breakdown Voltage ($I_D = 300\text{ mA}$, $V_{GS} = 0\text{ Vdc}$)	$V_{(BR)DSS}$	110	—	—	Vdc
Zero Gate Voltage Drain Leakage Current ($V_{DS} = 50\text{ Vdc}$, $V_{GS} = 0\text{ Vdc}$)	I_{DSS}	—	—	100	μA
Zero Gate Voltage Drain Leakage Current ($V_{DS} = 100\text{ Vdc}$, $V_{GS} = 0\text{ Vdc}$)	I_{DSS}	—	—	5	mA

On Characteristics

Gate Threshold Voltage (1) ($V_{DS} = 10\text{ Vdc}$, $I_D = 1600\ \mu\text{A}$)	$V_{GS(th)}$	1	1.63	3	Vdc
Gate Quiescent Voltage (2) ($V_{DD} = 50\text{ Vdc}$, $I_D = 150\text{ mA}$, Measured in Functional Test)	$V_{GS(Q)}$	1.5	2.2	3.5	Vdc
Drain-Source On-Voltage (1) ($V_{GS} = 10\text{ Vdc}$, $I_D = 4\text{ A}$)	$V_{DS(on)}$	—	0.28	—	Vdc

Dynamic Characteristics (1)

Reverse Transfer Capacitance ($V_{DS} = 50\text{ Vdc} \pm 30\text{ mV(rms)ac}$ @ 1 MHz, $V_{GS} = 0\text{ Vdc}$)	C_{rss}	—	3.3	—	pF
Output Capacitance ($V_{DS} = 50\text{ Vdc} \pm 30\text{ mV(rms)ac}$ @ 1 MHz, $V_{GS} = 0\text{ Vdc}$)	C_{oss}	—	147	—	pF
Input Capacitance ($V_{DS} = 50\text{ Vdc}$, $V_{GS} = 0\text{ Vdc} \pm 30\text{ mV(rms)ac}$ @ 1 MHz)	C_{iss}	—	506	—	pF

Functional Tests (2,3) (In Freescale Test Fixture, 50 ohm system) $V_{DD} = 50\text{ Vdc}$, $I_{DQ} = 150\text{ mA}$, $P_{out} = 1000\text{ W Peak}$ (200 W Avg.), $f = 130\text{ MHz}$, 100 μsec Pulse Width, 20% Duty Cycle

Power Gain	G_{ps}	24	26	28	dB
Drain Efficiency	η_D	69	71	—	%
Input Return Loss	IRL	—	-16	-9	dB

- Each side of device measured separately.
- Measurements made with device in push-pull configuration.
- Measurements made with device in straight lead configuration before any lead forming operation is applied. Lead forming is used for gull wing (GS) parts.

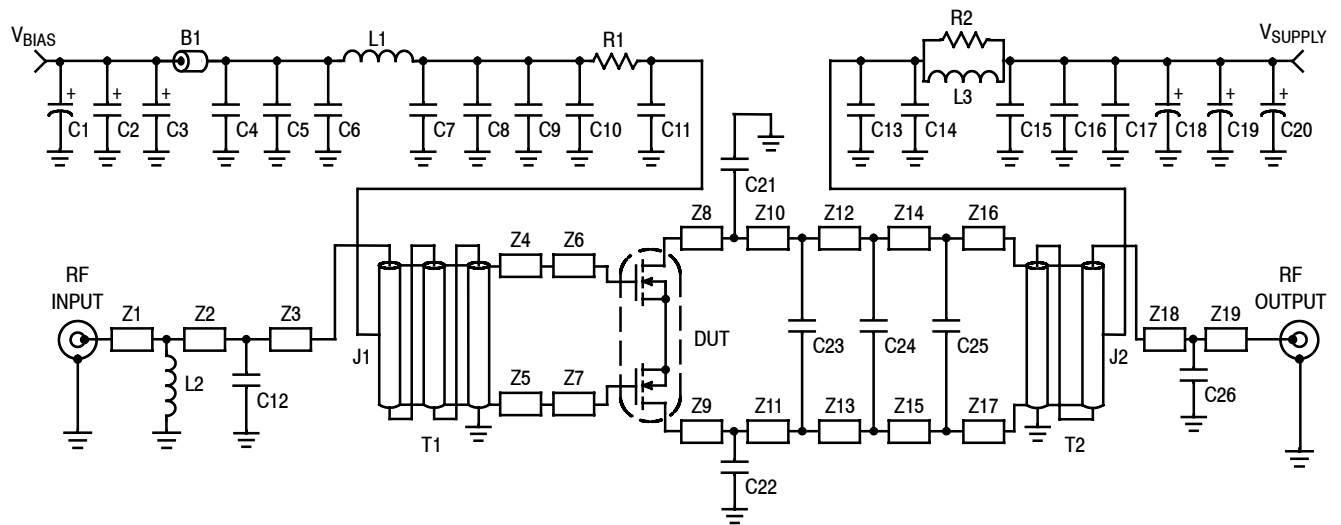

Z1	0.175" x 0.082" Microstrip	Z12, Z13	0.206" x 0.253" Microstrip
Z2*	1.461" x 0.082" Microstrip	Z14, Z15	0.116" x 0.253" Microstrip
Z3*	0.080" x 0.082" Microstrip	Z16*, Z17*	0.035" x 0.253" Microstrip
Z4, Z5	0.133" x 0.193" Microstrip	Z18	0.275" x 0.082" Microstrip
Z6, Z7, Z8, Z9	0.500" x 0.518" Microstrip	Z19	0.845" x 0.082" Microstrip
Z10, Z11	0.102" x 0.253" Microstrip		

*Line length includes microstrip bends.

Figure 2. MRF6VP11KHR6 Test Circuit Schematic

Table 5. MRF6VP11KHR6 Test Circuit Component Designations and Values

Part	Description	Part Number	Manufacturer
B1	95 Ω , 100 MHz Long Ferrite Bead	2743021447	Fair-Rite
C1	47 μ F, 50 V Electrolytic Capacitor	476KXM050M	Illinois Cap
C2	22 μ F, 35 V Tantalum Capacitor	T491X226K035AT	Kemet
C3	10 μ F, 35 V Tantalum Capacitor	T491D106K035AT	Kemet
C4, C9, C17	10K pF Chip Capacitors	ATC200B103KT50XT	ATC
C5, C16	20K pF Chip Capacitors	ATC200B203KT50XT	ATC
C6, C15	0.1 μ F, 50 V Chip Capacitors	CDR33BX104AKYS	Kemet
C7	2.2 μ F, 50 V Chip Capacitor	C1825C225J5RAC	Kemet
C8	0.22 μ F, 100 V Chip Capacitor	C1825C223K1GAC	Kemet
C10, C11, C13, C14	1000 pF Chip Capacitors	ATC100B102JT50XT	ATC
C12	18 pF Chip Capacitor	ATC100B180JT500XT	ATC
C18, C19, C20	470 μ F, 63 V Electrolytic Capacitors	MCGPR63V477M13X26-RH	Multicomp
C21, C22	47 pF Chip Capacitors	ATC100B470JT500XT	ATC
C23	75 pF Chip Capacitor	ATC100B750JT500XT	ATC
C24, C25	100 pF Chip Capacitors	ATC100B101JT500XT	ATC
C26	33 pF Chip Capacitor	ATC100B330JT500XT	ATC
J1, J2	Jumpers from PCB to T1 and T2	Copper Foil	
L1	82 nH Inductor	1812SMS-82NJLC	CoilCraft
L2	47 nH Inductor	1812SMS-47NJLC	CoilCraft
L3*	10 Turn, 18 AWG Inductor, Hand Wound	Copper Wire	
R1	1 K Ω , 1/4 W Carbon Leaded Resistor	MCCFR0W4J0102A50	Multicomp
R2	20 Ω , 3 W Chip Resistor	CPF320R000FKE14	Vishay
T1	Balun	TUI-9	Comm Concepts
T2	Balun	TUO-4	Comm Concepts
PCB	0.030", $\epsilon_r = 2.55$	CuClad 250GX-0300-55-22	Arlon

*L3 is wrapped around R2.

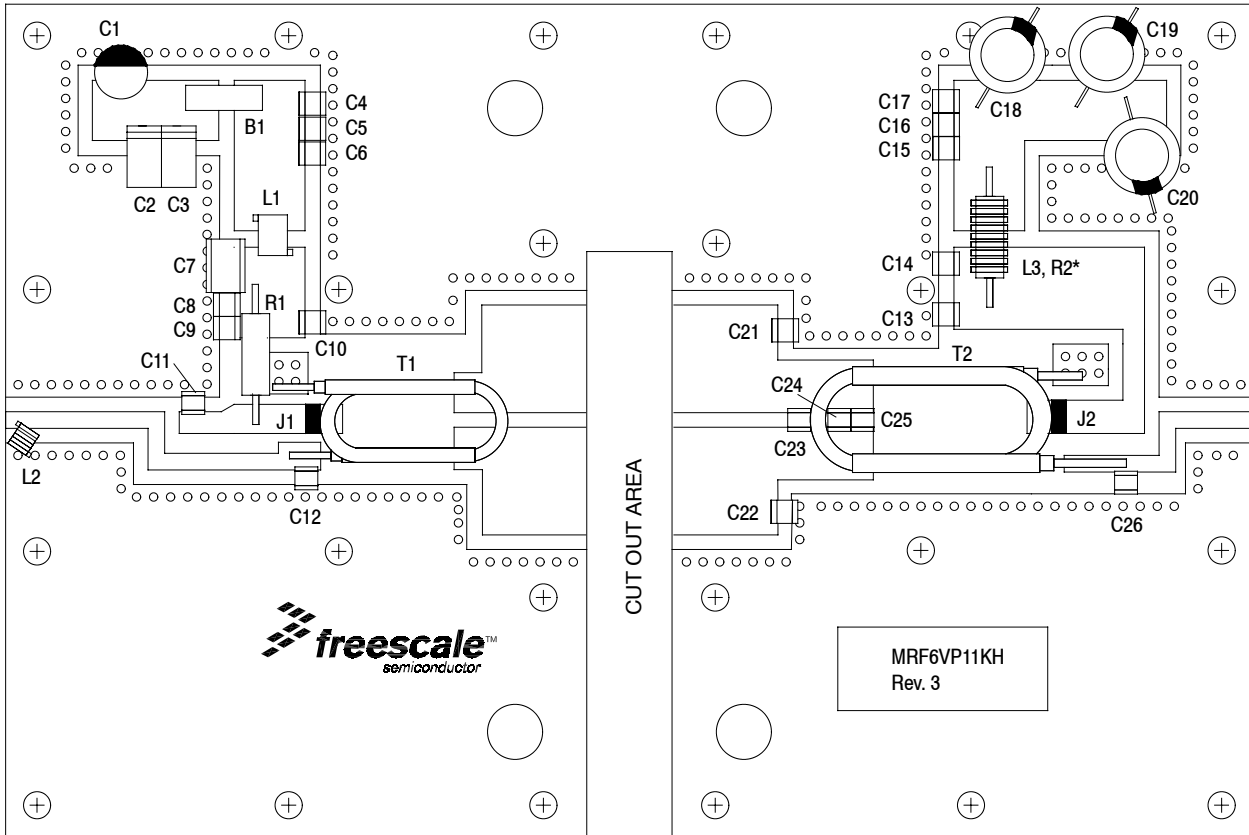

* L3 is wrapped around R2.

Figure 3. MRF6VP11KHR6 Test Circuit Component Layout

TYPICAL CHARACTERISTICS

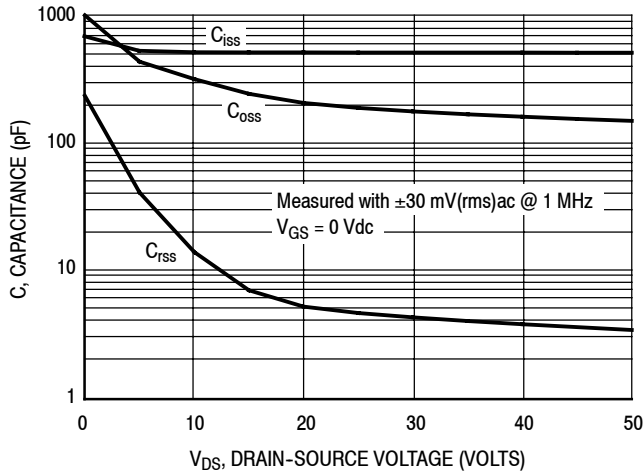

Note: Each side of device measured separately.

Figure 4. Capacitance versus Drain-Source Voltage

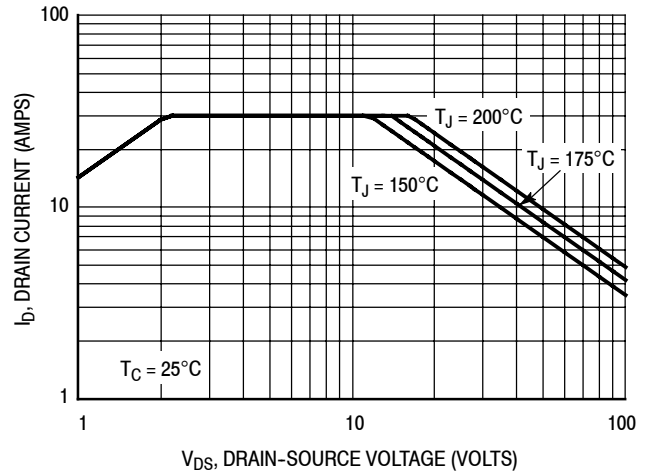

Note: Each side of device measured separately.

Figure 5. DC Safe Operating Area

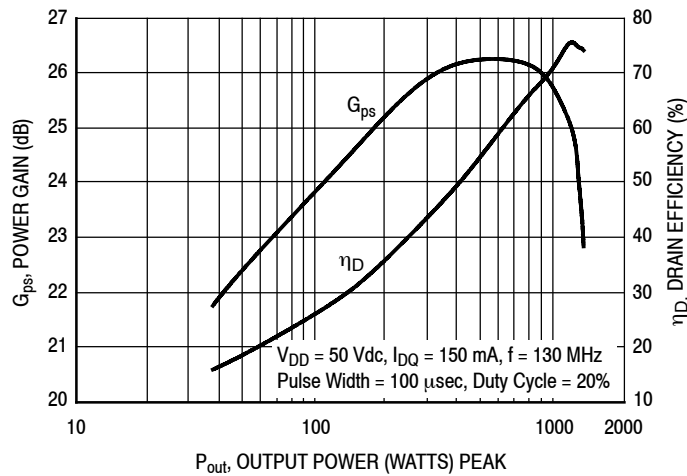

Figure 6. Power Gain and Drain Efficiency versus Output Power

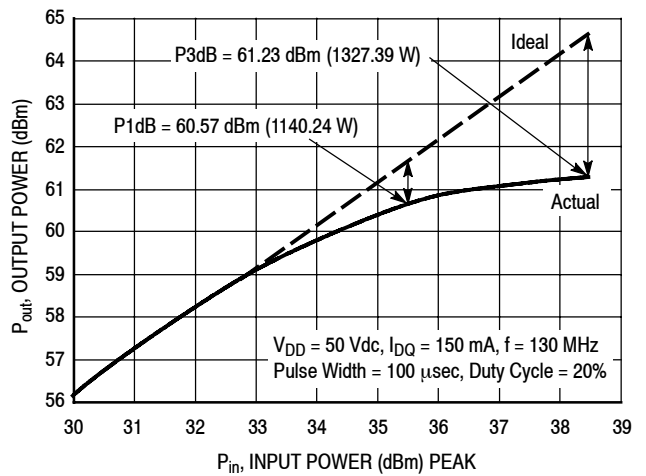

Figure 7. Output Power versus Input Power

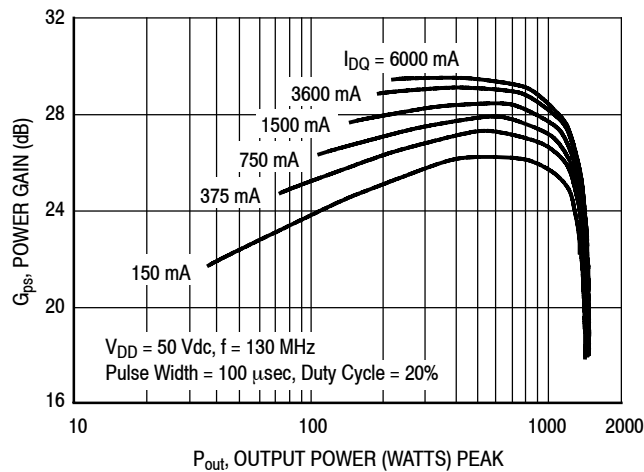

Figure 8. Power Gain versus Output Power

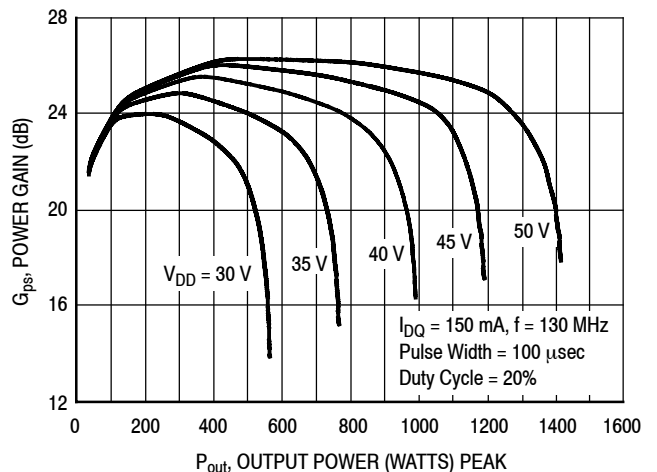

Figure 9. Power Gain versus Output Power

TYPICAL CHARACTERISTICS

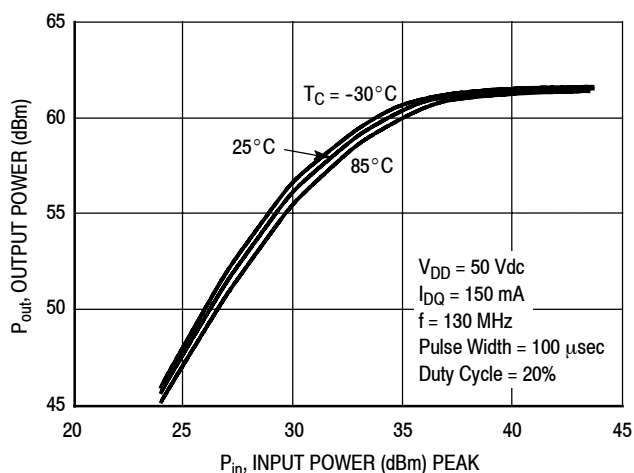

Figure 10. Output Power versus Input Power

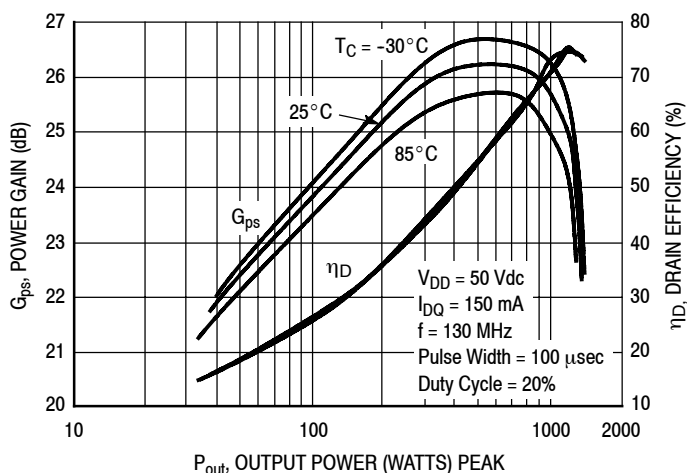

Figure 11. Power Gain and Drain Efficiency versus Output Power

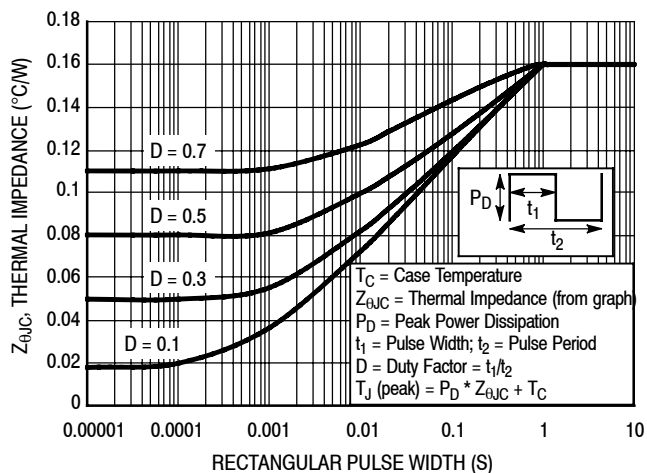
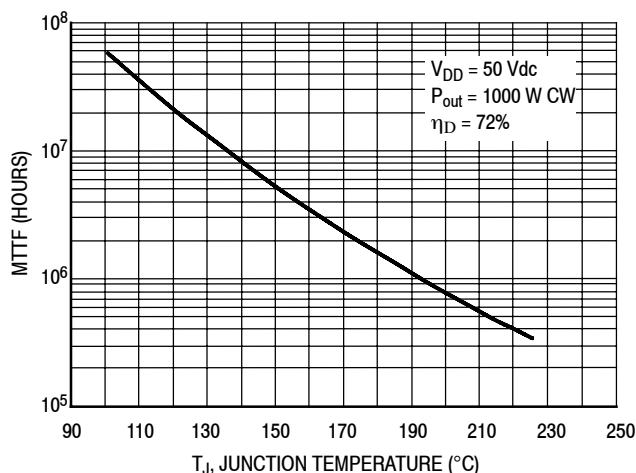

Figure 12. Transient Thermal Impedance



Note: MTTF value represents the total cumulative operating time under indicated test conditions.

MTTF calculator available at freescale.com/RFpower. Select Software & Tools/Development Tools/Calculators to access MTTF calculators by product.

For Pulse applications or CW conditions, use the MTTF calculator referenced above.

Figure 13. MTTF versus Junction Temperature - CW

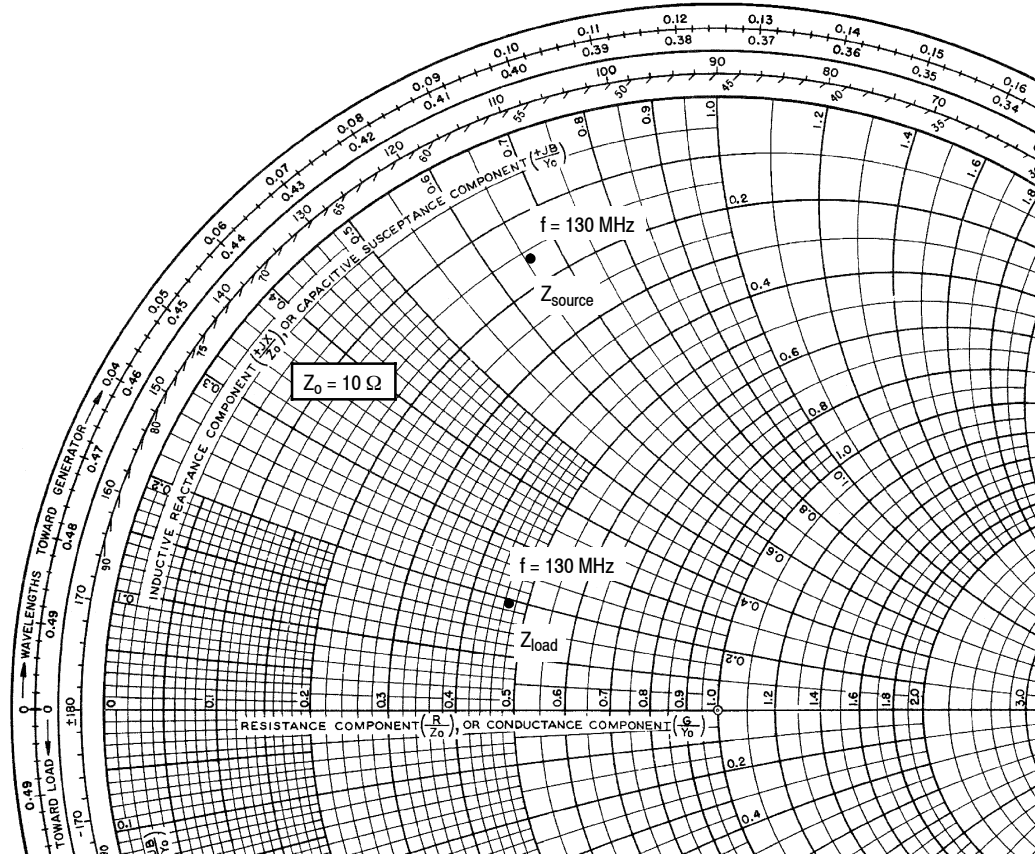

$V_{DD} = 50 \text{ Vdc}$, $I_{DQ} = 150 \text{ mA}$, $P_{out} = 1000 \text{ W Peak}$

f MHz	Z_{source} Ω	Z_{load} Ω
130	$1.58 + j6.47$	$4.6 + j1.85$

Z_{source} = Test circuit impedance as measured from gate to gate, balanced configuration.

Z_{load} = Test circuit impedance as measured from drain to drain, balanced configuration.

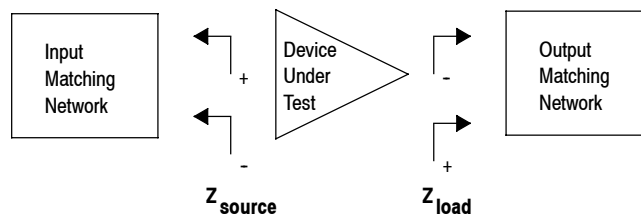
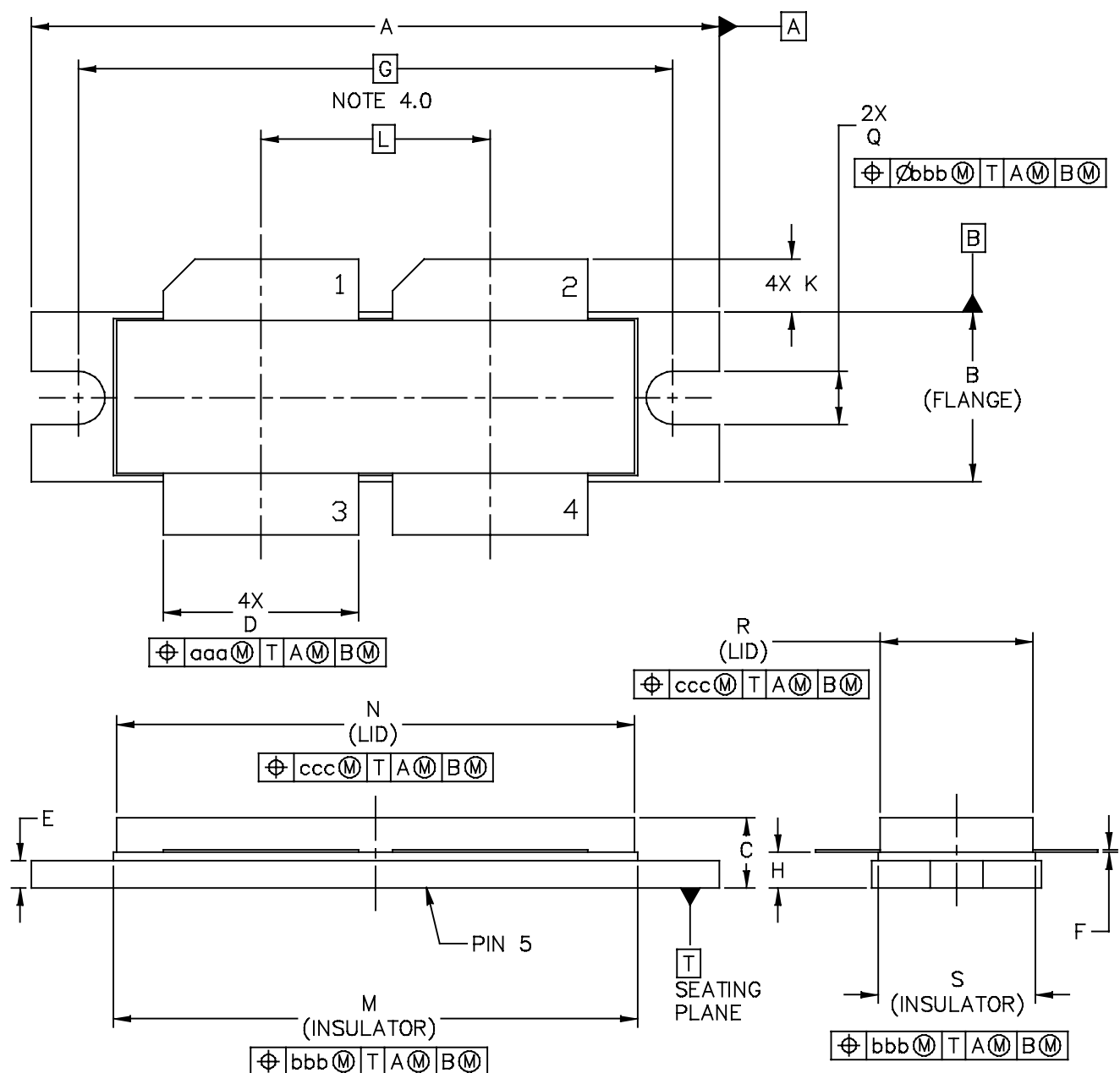

Figure 14. Series Equivalent Source and Load Impedance

PACKAGE DIMENSIONS



© FREESCALE SEMICONDUCTOR, INC. ALL RIGHTS RESERVED.		MECHANICAL OUTLINE	PRINT VERSION NOT TO SCALE
TITLE: NI-1230	DOCUMENT NO: 98ASB16977C		REV: E
	CASE NUMBER: 375D-05		31 MAR 2005
	STANDARD: NON-JEDEC		

NOTES:

- 1.0 INTERPRET DIMENSIONS AND TOLERANCES PER ASME Y14.5M-1994.
- 2.0 CONTROLLING DIMENSION: INCH
- 3.0 DIMENSION H IS MEASURED .030 (0.762) AWAY FROM PACKAGE BODY.
- 4.0 RECOMMENDED BOLT CENTER DIMENSION OF 1.52 (38.61) BASED ON M3 SCREW.

STYLE 1:

- PIN 1 - DRAIN
- 2 - DRAIN
- 3 - GATE
- 4 - GATE
- 5 - SOURCE

DIM	INCH		MILLIMETER		DIM	INCH		MILLIMETER	
	MIN	MAX	MIN	MAX		MIN	MAX	MIN	MAX
A	1.615	1.625	41.02	41.28	N	1.218	1.242	30.94	31.55
B	.395	.405	10.03	10.29	Q	.120	.130	3.05	3.3
C	.150	.200	3.81	5.08	R	.355	.365	9.01	9.27
D	.455	.465	11.56	11.81	S	.365	.375	9.27	9.53
E	.062	.066	1.57	1.68					
F	.004	.007	0.1	0.18					
G	1.400 BSC		35.56 BSC		aaa	.013		0.33	
H	.082	.090	2.08	2.29	bbb	.010		0.25	
K	.117	.137	2.97	3.48	ccc	.020		0.51	
L	.540 BSC		13.72 BSC						
M	1.219	1.241	30.96	31.52					
© FREESCALE SEMICONDUCTOR, INC. ALL RIGHTS RESERVED.			MECHANICAL OUTLINE			PRINT VERSION NOT TO SCALE			
TITLE: NI-1230					DOCUMENT NO: 98ASB16977C				REV: E
					CASE NUMBER: 375D-05				31 MAR 2005
					STANDARD: NON-JEDEC				

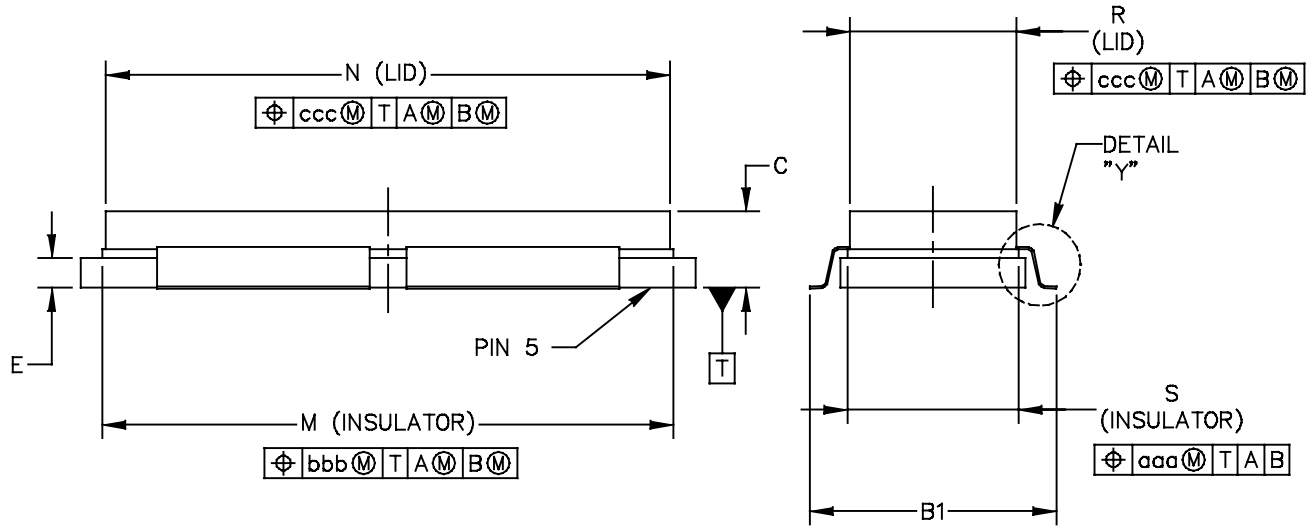
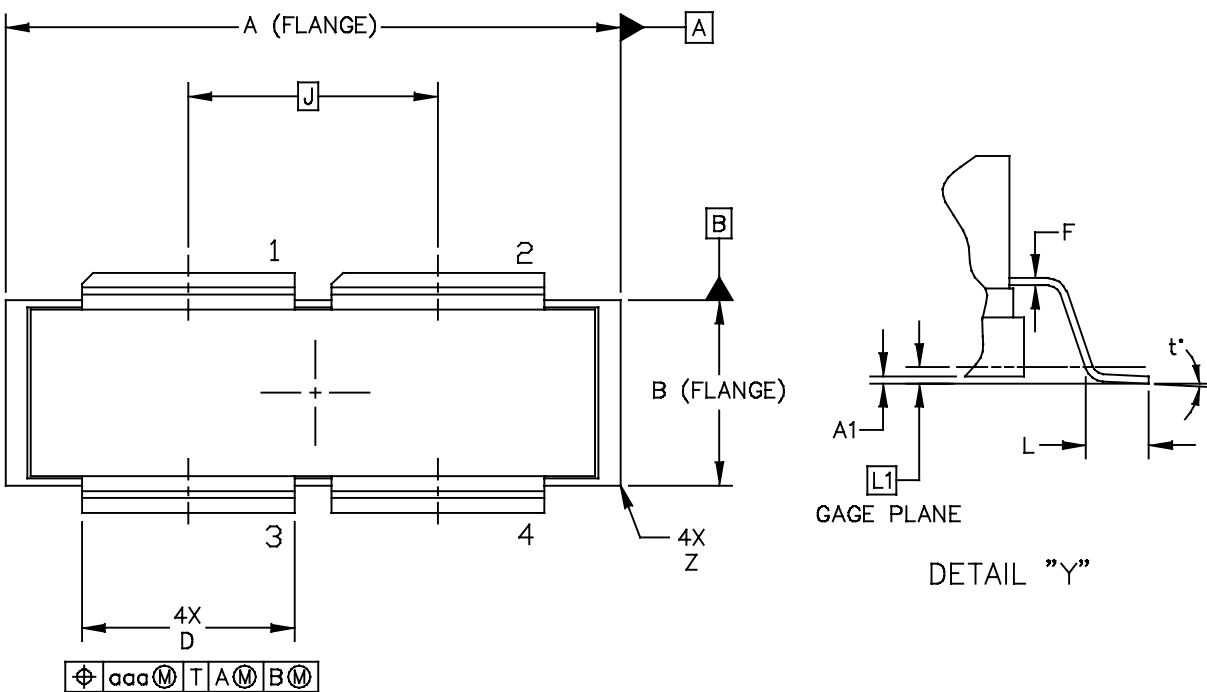

© FREESCALE SEMICONDUCTOR, INC. ALL RIGHTS RESERVED.		MECHANICAL OUTLINE	PRINT VERSION NOT TO SCALE
TITLE: NI-1230S-4 GULL		DOCUMENT NO: 98ASA00459D	REV: 0
		CASE NUMBER: 2282-02	10 AUG 2012
		STANDARD: NON-JEDEC	

NOTES:

1. INTERPRET DIMENSIONS AND TOLERANCES PER ASME Y14.5M-1994.
2. CONTROLLING DIMENSION: INCH
3. DIMENSION A1 IS MEASURED WITH REFERENCE TO DATUM T. THE POSITIVE VALUE IMPLIES THAT THE PACKAGE BOTTOM IS HIGHER THAN THE LEAD BOTTOM.

DIM	INCHES		MILLIMETERS		DIM	INCHES		MILLIMETERS	
	MIN	MAX	MIN	MAX		MIN	MAX	MIN	MAX
A	1.265	1.275	32.13	32.39	R	.355	.365	9.02	9.27
A1	-.001	.011	-0.03	0.28	S	.365	.375	9.27	9.53
B	.395	.405	10.03	10.29	Z	R.000	R.040	R0.00	R1.02
B1	.564	.574	14.32	14.58	t*	0*	8*	0*	8*
C	.150	.200	3.81	5.08					
D	.455	.465	11.56	11.81	aaa	.013		0.33	
E	.062	.066	1.57	1.68	bbb	.010		0.25	
F	.004	.007	0.10	0.18	ccc	.020		0.51	
J	.540 BSC		13.72 BSC						
L	.038	.046	0.97	1.17					
L1	.01 BSC		0.25 BSC						
M	1.219	1.241	30.96	31.52					
N	1.218	1.242	30.94	31.55					
© FREESCALE SEMICONDUCTOR, INC. ALL RIGHTS RESERVED.			MECHANICAL OUTLINE			PRINT VERSION NOT TO SCALE			
TITLE: NI-1230S-4 GULL					DOCUMENT NO: 98ASA00459D			REV: 0	
					CASE NUMBER: 2282-02			10 AUG 2012	
					STANDARD: NON-JEDEC				

Refer to the following documents to aid your design process.

Application Notes

- AN1955: Thermal Measurement Methodology of RF Power Amplifiers

Engineering Bulletins

- EB212: Using Data Sheet Impedances for RF LDMOS Devices

Software

- Electromigration MTTF Calculator
- RF High Power Model

For Software, do a Part Number search at <http://www.freescale.com>, and select the “Part Number” link. Go to the Software & Tools tab on the part’s Product Summary page to download the respective tool.

REVISION HISTORY

The following table summarizes revisions to this document.

Revision	Date	Description
0	Jan. 2008	• Initial Release of Data Sheet
1	Apr. 2008	• Corrected description and part number for the R1 resistor and updated R2 resistor to latest RoHS compliant part number in Table 5, Test Circuit Component Designations and Values, p. 3. • Added Fig. 12, Maximum Transient Thermal Impedance, p. 6
2	July 2008	• Added MTTF CW graph, Fig. 13, MTTF versus Junction Temperature, p. 6
3	Sept. 2008	• Added Note to Fig. 4, Capacitance versus Drain-Source Voltage, to denote that each side of device is measured separately, p. 5 • Updated Fig. 5, DC Safe Operating Area, to clarify that measurement is on a per-side basis, p. 5 • Corrected Fig. 13, MTTF versus Junction Temperature – CW, to reflect the correct die size and increased the MTTF factor accordingly, p. 6 • Corrected Fig. 14, MTTF versus Junction Temperature – Pulsed, to reflect the correct die size and increased the MTTF factor accordingly, p. 6
4	Dec. 2008	• Fig. 15, Series Equivalent Source and Load Impedance, corrected Z_{source} copy to read “Test circuit impedance as measured from gate to gate, balanced configuration” and Z_{load} copy to read “Test circuit impedance as measured from drain to drain, balanced configuration”, p. 7
5	July 2009	• Added 1000 W CW thermal data at 100 MHz to Thermal Characteristics table, p. 1 • Changed “EKME630ELL471MK25S” part number to “MCGPR63V477M13X26-RH”, changed R1 Description from “1 K Ω , 1/4 W Axial Leaded Resistor” to “1 K Ω , 1/4 W Carbon Leaded Resistor” and “CMF601000ROFKEK” part number to “MCCFR0W4J0102A50”, Table 5, Test Circuit Component Designations and Values, p. 3 • Corrected Fig. 13, MTTF versus Junction Temperature – CW, to reflect change in Drain Efficiency from 70% to 72%, p. 6 • Added Electromigration MTTF Calculator and RF High Power Model availability to Product Documentation, Tools and Software, p. 20
6	Dec. 2009	• Device frequency range improved from 10–150 MHz to 1.8–150 MHz, p. 1 • Reporting of pulsed thermal data now shown using the $Z_{\theta JC}$ symbol, Table 2. Thermal Characteristics, p. 1
7	Apr. 2010	• Operating Junction Temperature increased from 200°C to 225°C in Maximum Ratings table and related “Continuous use at maximum temperature will affect MTTF” footnote added, p. 1
8	Sept. 2012	• Added part number MRF6VP11KGSR5, p. 1 • Added 2282-02 (NI-1230S-4 Gull) package isometric, p. 1, and Mechanical Outline, p. 10, 11 • Table 3, ESD Protection Characteristics: added the device’s ESD passing level as applicable to each ESD class, p. 2 • Modified figure titles and/or graph axes labels to clarify application use, p. 5, 6 • Fig. 12, Transient Thermal Impedance: graph updated to show correct CW operation, p. 6 • Fig. 13, MTTF versus Junction Temperature – CW: MTTF end temperature on graph changed to match maximum operating junction temperature, p. 6 • Fig. 14, MTTF versus Junction Temperature – Pulsed removed, p. 6. Refer to the device’s MTTF Calculator available at freescale.com/RFpower . Select Software & Tools/Development Tools/Calculators to access MTTF calculators by product.

How to Reach Us:

Home Page:
freescale.com

Web Support:
freescale.com/support

Information in this document is provided solely to enable system and software implementers to use Freescale products. There are no express or implied copyright licenses granted hereunder to design or fabricate any integrated circuits based on the information in this document.

Freescale reserves the right to make changes without further notice to any products herein. Freescale makes no warranty, representation, or guarantee regarding the suitability of its products for any particular purpose, nor does Freescale assume any liability arising out of the application or use of any product or circuit, and specifically disclaims any and all liability, including without limitation consequential or incidental damages. "Typical" parameters that may be provided in Freescale data sheets and/or specifications can and do vary in different applications, and actual performance may vary over time. All operating parameters, including "typicals," must be validated for each customer application by customer's technical experts. Freescale does not convey any license under its patent rights nor the rights of others. Freescale sells products pursuant to standard terms and conditions of sale, which can be found at the following address: freescale.com/SalesTermsandConditions.

Freescale, the Freescale logo, Altivec, C-5, CodeTest, CodeWarrior, ColdFire, C-Ware, Energy Efficient Solutions logo, Kinetis, mobileGT, PowerQUICC, Processor Expert, QorIQ, Qorivva, StarCore, Symphony, and VortiQa are trademarks of Freescale Semiconductor, Inc., Reg. U.S. Pat. & Tm. Off. Airfast, BeeKit, BeeStack, ColdFire+, CoreNet, Flexis, MagniV, MXC, Platform in a Package, QorIQ Qonverge, QUICC Engine, Ready Play, SafeAssure, SMARTMOS, TurboLink, Vybrid, and Xtrinsic are trademarks of Freescale Semiconductor, Inc. All other product or service names are the property of their respective owners.

© 2008-2010, 2012 Freescale Semiconductor, Inc.

Mouser Electronics

Authorized Distributor

Click to View Pricing, Inventory, Delivery & Lifecycle Information:

[Freescale Semiconductor:](#)

[MRF6VP11KHR5](#) [MRF6VP11KGSR5](#)