



15GN01CA

RF Transistor 8V, 50mA, $f_T=1.5\text{GHz}$, NPN Single CP

ON Semiconductor®
<http://onsemi.com>

Features

- Small ON-resistance [$R_{on}=2\Omega$ ($I_B=3\text{mA}$)]
- Small output capacitance [$C_{ob}=1.2\text{pF}$ ($V_{CB}=10\text{V}$)]

Specifications

Absolute Maximum Ratings at $T_a=25^\circ\text{C}$

Parameter	Symbol	Conditions	Ratings	Unit
Collector-to-Base Voltage	V_{CBO}		15	V
Collector-to-Emitter Voltage	V_{CEO}		8	V
Emitter-to-Base Voltage	V_{EBO}		3	V
Collector Current	I_C		50	mA
Collector Dissipation	P_C		200	mW
Junction Temperature	T_j		150	$^\circ\text{C}$
Storage Temperature	T_{stg}		-55 to +150	$^\circ\text{C}$

Stresses exceeding Maximum Ratings may damage the device. Maximum Ratings are stress ratings only. Functional operation above the Recommended Operating Conditions is not implied. Extended exposure to stresses above the Recommended Operating Conditions may affect device reliability.

Package Dimensions

unit : mm (typ)

7013A-009

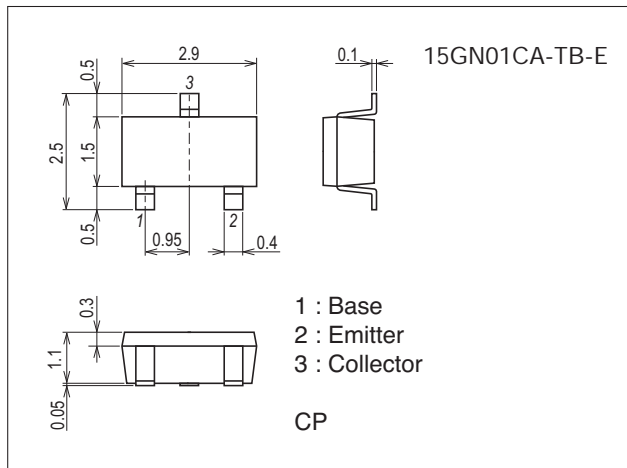

Product & Package Information

- Package : CP
- JEITA, JEDEC : SC-59, TO-236, SOT-23, TO-236AB
- Minimum Packing Quantity : 3,000 pcs./reel

Packing Type: TB

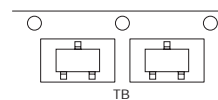

Marking

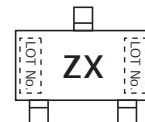

Electrical Connection

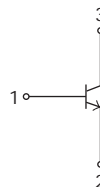

15GN01CA

Electrical Characteristics at Ta=25°C

Parameter	Symbol	Conditions	Ratings			Unit
			min	typ	max	
Collector Cutoff Current	I_{CBO}	$V_{CB}=10V, I_E=0A$			0.5	μA
Emitter Cutoff Current	I_{EBO}	$V_{EB}=2V, I_C=0A$			0.5	μA
DC Current Gain	h_{FE}	$V_{CE}=5V, I_C=10mA$	200		400	
Gain-Bandwidth Product	f_T	$V_{CE}=5V, I_C=10mA$	1.0	1.5		GHz
Output Capacitance	C_{ob}	$V_{CB}=10V, f=1MHz$		1.2	1.6	pF
Collector-to-Emitter Saturation Voltage	$V_{CE(sat)}$	$I_C=20mA, I_B=2mA$		0.06	0.12	V
Output ON resistance	R_{on}	$I_B=3mA, f=10kHz$		2.0		Ω

Ordering Information

Device	Package	Shipping	memo
15GN01CA-TB-E	CP	3,000pcs./reel	Pb Free

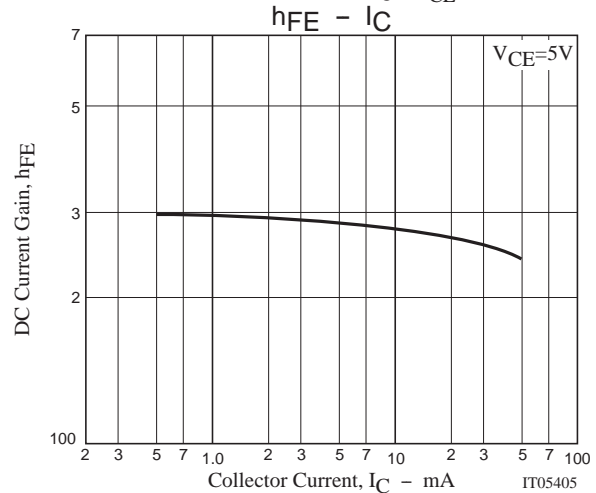
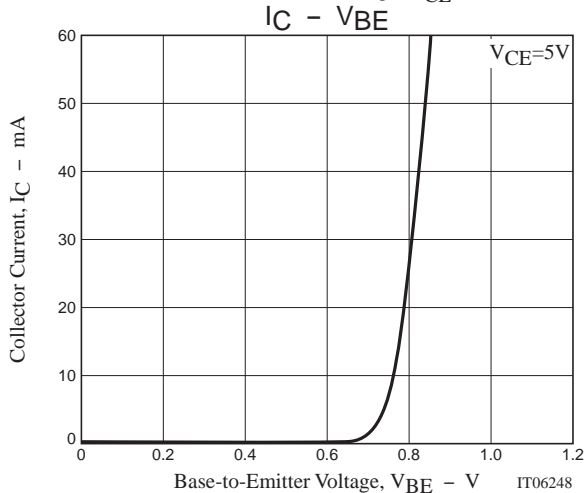
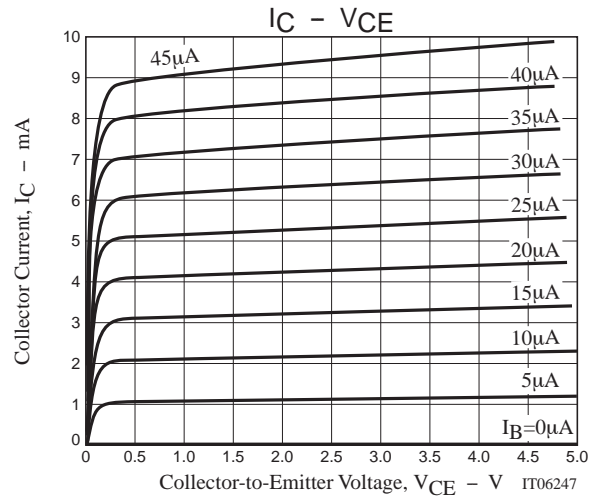
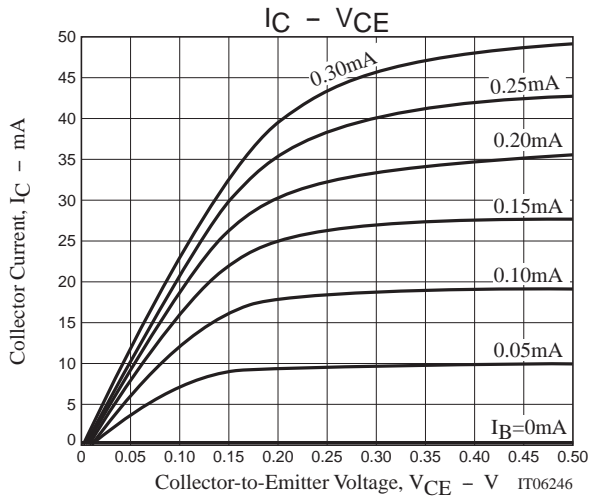

15GN01CA

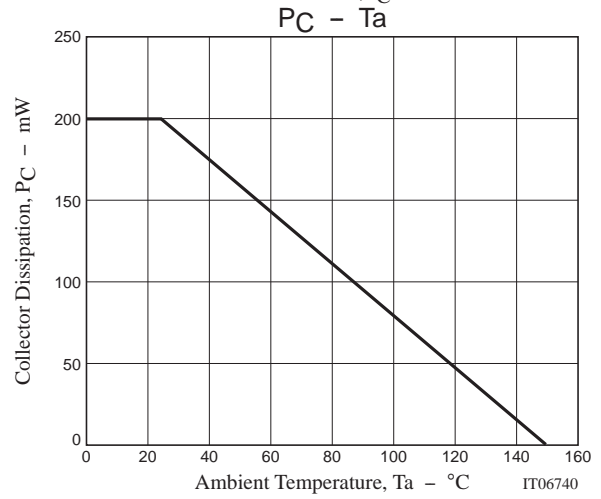
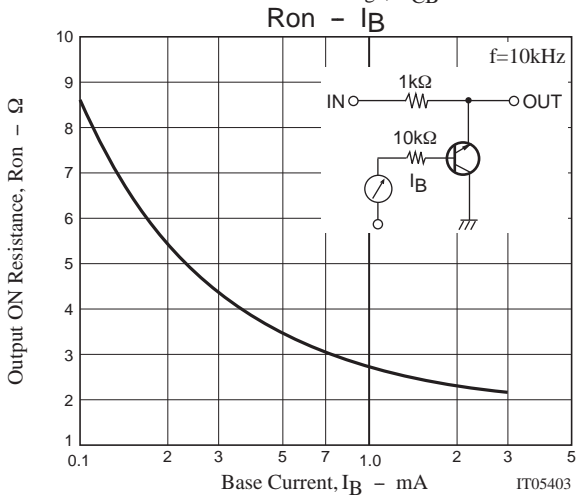
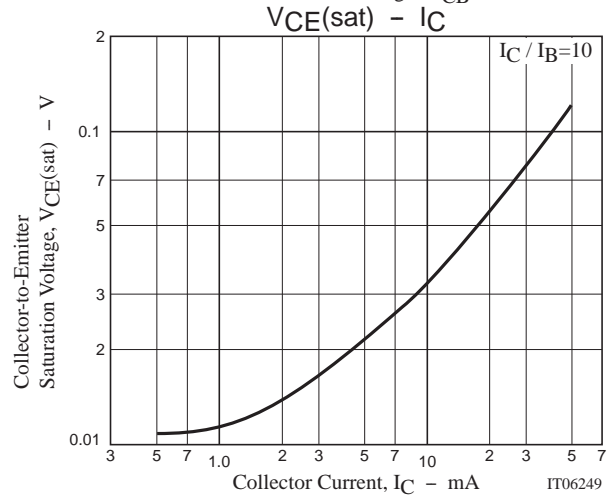
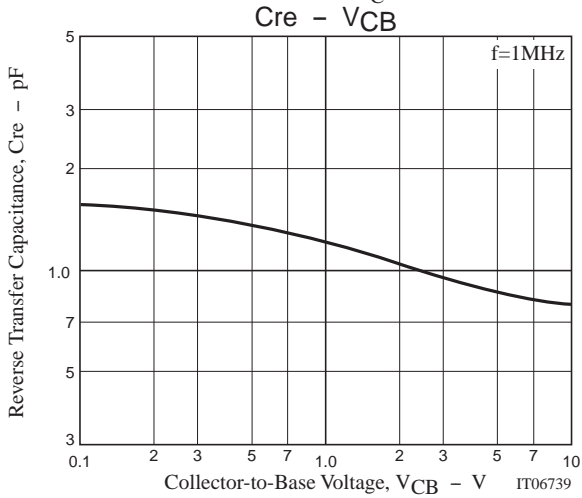
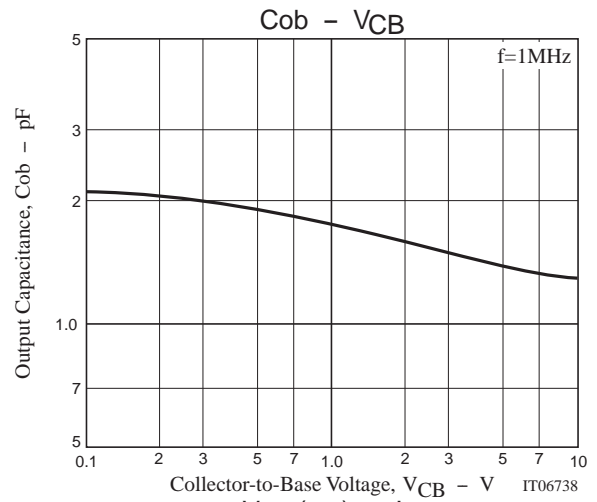
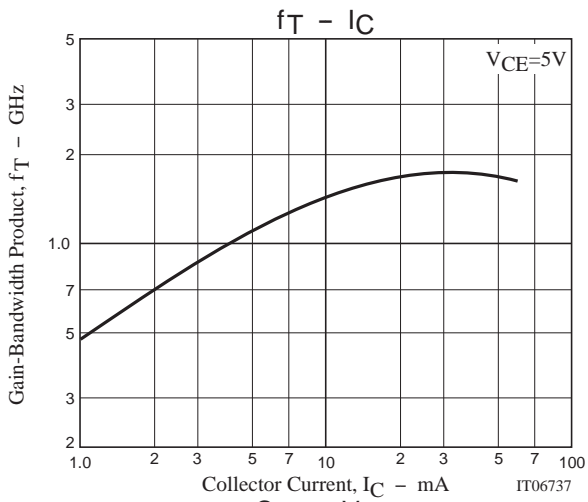

15GN01CA

S Parameters (Common emitter)

$V_{CE}=5V, I_C=5mA, Z_O=50\Omega$

Freq(MHz)	S11	$\angle S11$	S21	$\angle S21$	S12	$\angle S12$	S22	$\angle S22$
100	0.650	-26.84	4.392	121.74	0.029	71.26	0.776	-10.73
200	0.554	-37.39	2.798	110.97	0.050	66.90	0.737	-14.52
300	0.494	-47.15	2.148	103.12	0.070	63.30	0.720	-18.26
400	0.444	-56.64	1.787	96.10	0.087	61.98	0.708	-22.11
500	0.406	-65.32	1.537	89.48	0.101	59.57	0.697	-25.85
600	0.377	-73.55	1.369	83.71	0.113	57.85	0.691	-29.52
700	0.348	-83.03	1.245	77.82	0.126	56.52	0.687	-33.29
800	0.325	-90.95	1.137	72.30	0.137	54.57	0.684	-37.14
900	0.306	-99.25	1.058	67.12	0.148	53.75	0.682	-40.75
1000	0.288	-107.53	0.990	62.37	0.153	52.46	0.682	-44.56

$V_{CE}=5V, I_C=10mA, Z_O=50\Omega$

Freq(MHz)	S11	$\angle S11$	S21	$\angle S21$	S12	$\angle S12$	S22	$\angle S22$
100	0.583	-32.15	6.240	118.82	0.026	70.44	0.703	-12.56
200	0.482	-45.75	3.926	108.10	0.046	66.49	0.659	-15.99
300	0.419	-57.88	2.944	99.96	0.063	65.05	0.637	-19.29
400	0.368	-69.02	2.390	92.67	0.078	62.34	0.624	-22.85
500	0.336	-79.50	2.027	86.17	0.092	61.46	0.615	-26.37
600	0.310	-89.29	1.769	80.51	0.103	60.64	0.610	-29.81
700	0.291	-99.92	1.586	74.79	0.114	59.47	0.606	-33.39
800	0.274	-108.75	1.441	69.42	0.125	58.90	0.605	-37.06
900	0.262	-118.49	1.317	64.61	0.135	57.84	0.605	-40.43
1000	0.251	-127.56	1.217	59.88	0.144	57.55	0.606	-44.25

$V_{CE}=5V, I_C=20mA, Z_O=50\Omega$

Freq(MHz)	S11	$\angle S11$	S21	$\angle S21$	S12	$\angle S12$	S22	$\angle S22$
100	0.513	-40.12	8.263	115.87	0.025	68.95	0.625	-14.43
200	0.407	-57.84	5.054	104.00	0.043	68.30	0.576	-17.14
300	0.347	-73.04	3.701	95.34	0.056	66.04	0.557	-19.89
400	0.303	-87.02	2.936	87.98	0.071	64.63	0.545	-22.91
500	0.281	-98.99	2.433	81.63	0.083	64.43	0.538	-26.26
600	0.266	-110.32	2.091	76.17	0.095	63.54	0.537	-29.36
700	0.257	-122.12	1.853	70.61	0.106	63.34	0.536	-33.02
800	0.248	-131.81	1.662	65.60	0.117	62.91	0.538	-36.53
900	0.244	-141.38	1.504	60.76	0.128	62.37	0.538	-39.95
1000	0.245	-150.77	1.376	56.40	0.137	62.62	0.540	-43.80

$V_{CE}=5V, I_C=30mA, Z_O=50\Omega$

Freq(MHz)	S11	$\angle S11$	S21	$\angle S21$	S12	$\angle S12$	S22	$\angle S22$
100	0.471	-46.44	9.316	113.49	0.025	70.19	0.582	-15.62
200	0.368	-67.17	5.557	100.99	0.040	68.06	0.532	-17.38
300	0.313	-84.43	3.987	92.10	0.053	66.90	0.516	-19.75
400	0.280	-100.24	3.124	84.66	0.067	65.61	0.506	-22.58
500	0.265	-112.71	2.570	78.56	0.080	66.29	0.504	-25.96
600	0.256	-124.16	2.191	73.18	0.092	65.10	0.502	-29.15
700	0.255	-135.95	1.921	67.77	0.103	66.41	0.502	-32.85
800	0.252	-145.81	1.714	62.74	0.113	65.20	0.506	-36.31
900	0.254	-154.35	1.544	58.35	0.125	65.56	0.508	-39.87
1000	0.255	-163.19	1.411	53.83	0.137	64.48	0.513	-43.71

15GN01CA

Embossed Taping Specification

15GN01CA-TB-E

1. Packing Format

Package Name	Carrier Tape Type	Maximum Number of devices contained (pcs)			Packing format	
		Reel	Inner box	Outer box	Inner BOX (C-1)	Outer BOX (A-7)
CP	CP	3,000	15,000	90,000	5 reels contained Dimensions:mm (external) 183×72×185	6 inner boxes contained Dimensions:mm (external) 440×195×210

Packing method

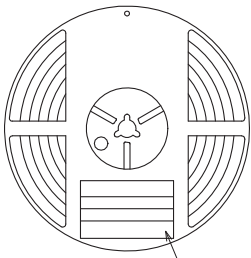

Reel label

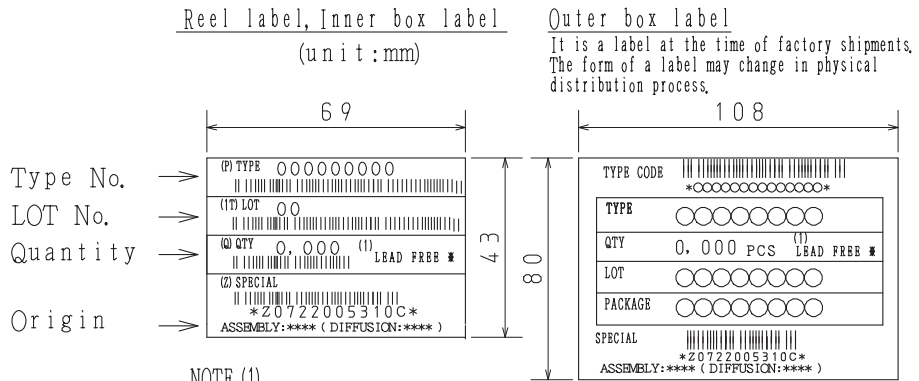

NOTE (1)

The LEAD FREE * description shows that the surface treatment of the terminal is lead free.

Label	JEITA Phase
LEAD FREE 3	JEITA Phase 3A
LEAD FREE 4	JEITA Phase 3

2. Taping configuration

2-1. Carrier tape size (unit:mm)

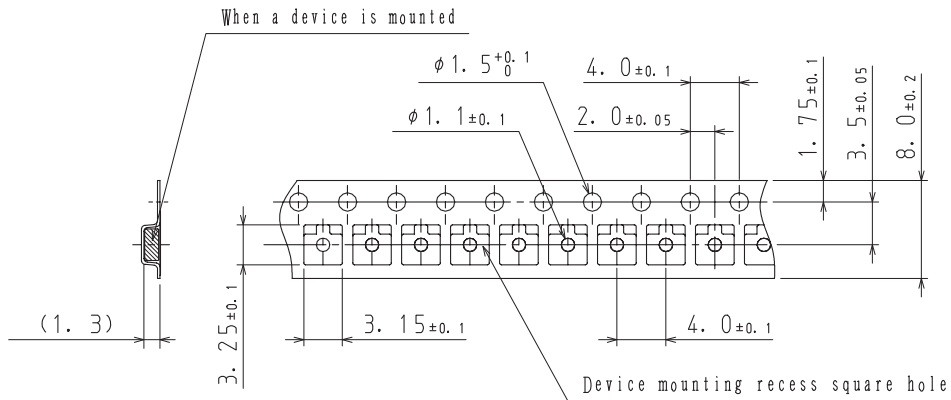

2-2. Device placement direction

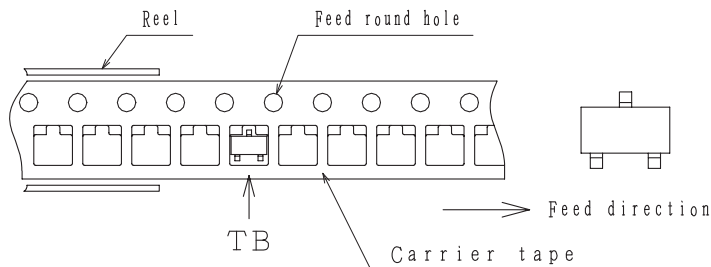

Those with one electrode terminal on the feed hole side.....TB

15GN01CA

Outline Drawing 15GN01CA-TB-E

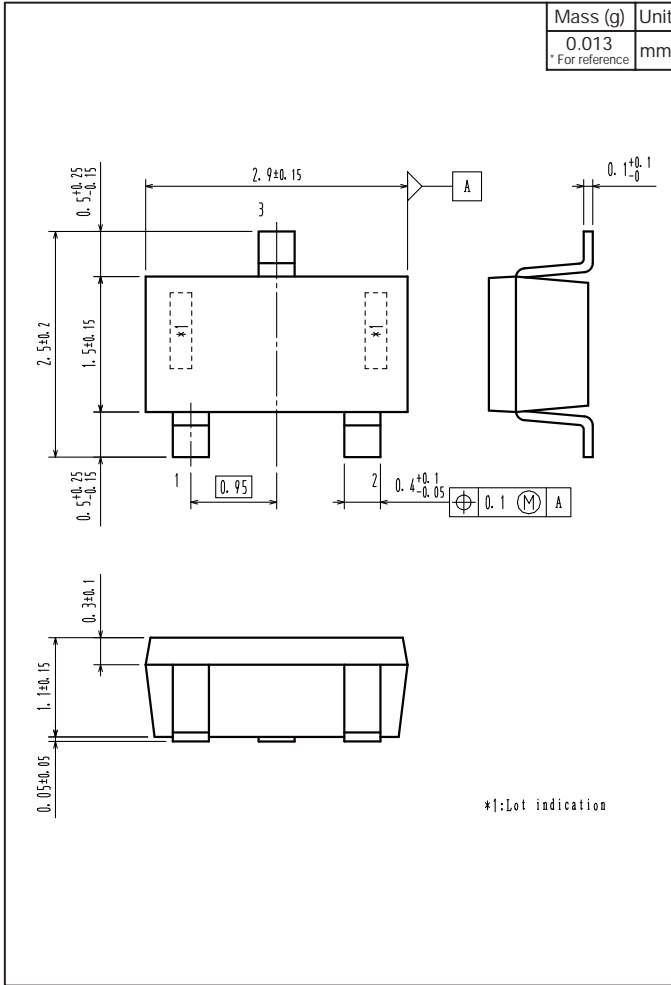

Land Pattern Example

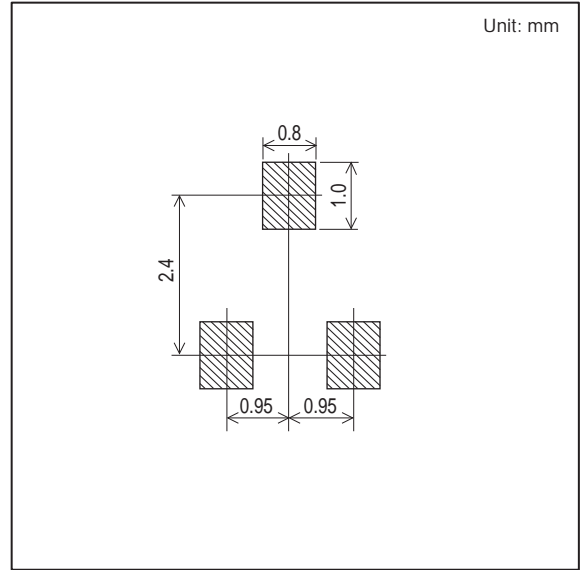

ON Semiconductor and the ON logo are registered trademarks of Semiconductor Components Industries, LLC (SCILLC). SCILLC owns the rights to a number of patents, trademarks, copyrights, trade secrets, and other intellectual property. A listing of SCILLC's product/patent coverage may be accessed at www.onsemi.com/site/pdf/Patent-Marking.pdf. SCILLC reserves the right to make changes without further notice to any products herein. SCILLC makes no warranty, representation or guarantee regarding the suitability of its products for any particular purpose, nor does SCILLC assume any liability arising out of the application or use of any product or circuit, and specifically disclaims any and all liability, including without limitation special, consequential or incidental damages. "Typical" parameters which may be provided in SCILLC data sheets and/or specifications can and do vary in different applications and actual performance may vary over time. All operating parameters, including "Typicals" must be validated for each customer application by customer's technical experts. SCILLC does not convey any license under its patent rights nor the rights of others. SCILLC products are not designed, intended, or authorized for use as components in systems intended for surgical implant into the body, or other applications intended to support or sustain life, or for any other application in which the failure of the SCILLC product could create a situation where personal injury or death may occur. Should Buyer purchase or use SCILLC products for any such unintended or unauthorized application, Buyer shall indemnify and hold SCILLC and its officers, employees, subsidiaries, affiliates, and distributors harmless against all claims, costs, damages, and expenses, and reasonable attorney fees arising out of, directly or indirectly, any claim of personal injury or death associated with such unintended or unauthorized use, even if such claim alleges that SCILLC was negligent regarding the design or manufacture of the part. SCILLC is an Equal Opportunity/Affirmative Action Employer. This literature is subject to all applicable copyright laws and is not for resale in any manner.

Mouser Electronics

Authorized Distributor

Click to View Pricing, Inventory, Delivery & Lifecycle Information:

[ON Semiconductor:](#)

[15GN01CA-TB-E](#)