

MBR140SF, NRVB140SF

Surface Mount Schottky Power Rectifier

Plastic SOD-123 Package

This device uses the Schottky Barrier principle with a large area metal-to-silicon power diode. Ideally suited for low voltage, high frequency rectification or as free wheeling and polarity protection diodes in surface mount applications where compact size and weight are critical to the system. This package also provides an easy to work with alternative to leadless 34 package style. Because of its small size, it is ideal for use in portable and battery powered products such as cellular and cordless phones, chargers, notebook computers, printers, PDAs and PCMCIA cards. Typical applications are AC-DC and DC-DC converters, reverse battery protection, and “Oring” of multiple supply voltages and any other application where performance and size are critical.

Features

- Guardring for Stress Protection
- Low Forward Voltage
- 125°C Operating Junction Temperature
- Epoxy Meets UL 94 V-0 @ 0.125 in
- Package Designed for Optimal Automated Board Assembly
- ESD Rating:
 - ◆ Human Body Model = 3B
 - ◆ Machine Model = C
- NRVB Prefix for Automotive and Other Applications Requiring Unique Site and Control Change Requirements; AEC-Q101 Qualified and PPAP Capable
- These Devices are Pb-Free, Halogen Free/BFR Free and are RoHS Compliant

Mechanical Characteristics

- Device Marking: L4F
- Polarity Designator: Cathode Band
- Weight: 11.7 mg (approximately)
- Case: Epoxy, Molded
- Finish: All External Surfaces Corrosion Resistant and Terminal Leads are Readily Solderable
- Lead and Mounting Surface Temperature for Soldering Purposes: 260°C Max. for 10 Seconds



ON Semiconductor®

<http://onsemi.com>

**SCHOTTKY BARRIER
RECTIFIER
1.0 AMPERES
40 VOLTS**

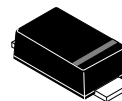

**SOD-123FL
CASE 498**

MARKING DIAGRAM

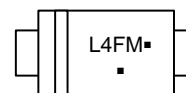

L4F = Specific Device Code
M = Date Code
▪ = Pb-Free Package

(Note: Microdot may be in either location)

ORDERING INFORMATION

| Device | Package | Shipping† |
|--------------|------------------------|-----------------------------|
| MBR140SFT1G | SOD-123FL (Pb-Free) | 3,000 / Tape & Reel ** |
| NRVB140SFT1G | SOD-123FL (Pb-Free) | 3,000 / Tape & Reel ** |
| MBR140SFT3G | SOD-123FL (Pb-Free) | 10,000 / Tape & Reel *** |
| NRVB140SFT3G | SOD-123FL (Pb-Free) | 10,000 / Tape & Reel *** |

** 8 mm Tape, 7" Reel

*** 8 mm Tape, 13" Reel

†For information on tape and reel specifications, including part orientation and tape sizes, please refer to our Tape and Reel Packaging Specifications Brochure, BRD8011/D.

MBR140SF, NRVB140SF

MAXIMUM RATINGS

| Rating | Symbol | Value | Unit |
|---|---------------------------------|------------|------------------|
| Peak Repetitive Reverse Voltage Working Peak Reverse Voltage DC Blocking Voltage | V_{RRM} V_{RWM} V_R | 40 | V |
| Average Rectified Forward Current (At Rated V_R , $T_L = 112^\circ\text{C}$) | I_O | 1.0 | A |
| Peak Repetitive Forward Current (At Rated V_R , Square Wave, 100 kHz, $T_L = 95^\circ\text{C}$) | I_{FRM} | 2.0 | A |
| Non-Repetitive Peak Surge Current (Non-Repetitive peak surge current, halfwave, single phase, 60 Hz) | I_{FSM} | 30 | A |
| Storage Temperature | T_{stg} | -55 to 150 | $^\circ\text{C}$ |
| Operating Junction Temperature | T_J | -55 to 125 | $^\circ\text{C}$ |
| Voltage Rate of Change (Rated V_R , $T_J = 25^\circ\text{C}$) | dv/dt | 10,000 | V/ μs |

Stresses exceeding those listed in the Maximum Ratings table may damage the device. If any of these limits are exceeded, device functionality should not be assumed, damage may occur and reliability may be affected.

THERMAL CHARACTERISTICS

| Characteristic | Symbol | Value | Unit |
|--|-----------|-------|---------------------------|
| Thermal Resistance, Junction-to-Lead (Note 1) | R_{tjl} | 26 | $^\circ\text{C}/\text{W}$ |
| Thermal Resistance, Junction-to-Lead (Note 2) | R_{tjl} | 21 | |
| Thermal Resistance, Junction-to-Ambient (Note 1) | R_{tja} | 325 | |
| Thermal Resistance, Junction-to-Ambient (Note 2) | R_{tja} | 82 | |

- Mounted with minimum recommended pad size, PC Board FR4.
- Mounted with 1 in. copper pad (Cu area 700 mm²).

ELECTRICAL CHARACTERISTICS

| Characteristic | Symbol | Value | | Unit |
|--|--------|--------------------------|--------------------------|------|
| | | $T_J = 25^\circ\text{C}$ | $T_J = 85^\circ\text{C}$ | |
| Maximum Instantaneous Forward Voltage (Note 3), See Figure 2 ($I_F = 0.1\text{ A}$) ($I_F = 1.0\text{ A}$) ($I_F = 3.0\text{ A}$) | V_F | $T_J = 25^\circ\text{C}$ | $T_J = 85^\circ\text{C}$ | V |
| | | 0.36 | 0.30 | |
| | | 0.55 | 0.515 | |
| | | 0.85 | 0.88 | |
| Maximum Instantaneous Reverse Current (Note 3), See Figure 4 ($V_R = 40\text{ V}$) ($V_R = 20\text{ V}$) | I_R | $T_J = 25^\circ\text{C}$ | $T_J = 85^\circ\text{C}$ | mA |
| | | 0.5 | 25 | |
| | | 0.15 | 18 | |

Product parametric performance is indicated in the Electrical Characteristics for the listed test conditions, unless otherwise noted. Product performance may not be indicated by the Electrical Characteristics if operated under different conditions.

- Pulse Test: Pulse Width $\leq 250\ \mu\text{s}$, Duty Cycle $\leq 2\%$.

MBR140SF, NRVB140SF

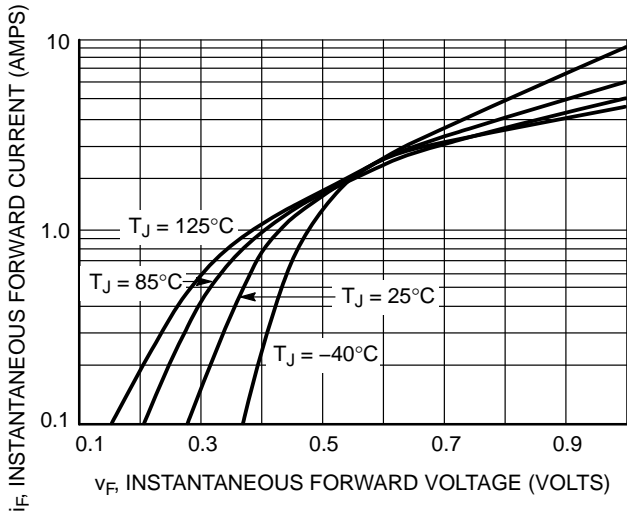

Figure 1. Typical Forward Voltage

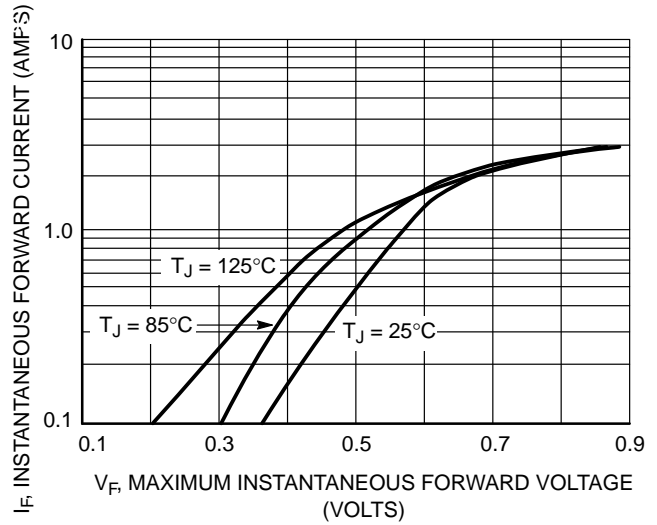

Figure 2. Maximum Forward Voltage

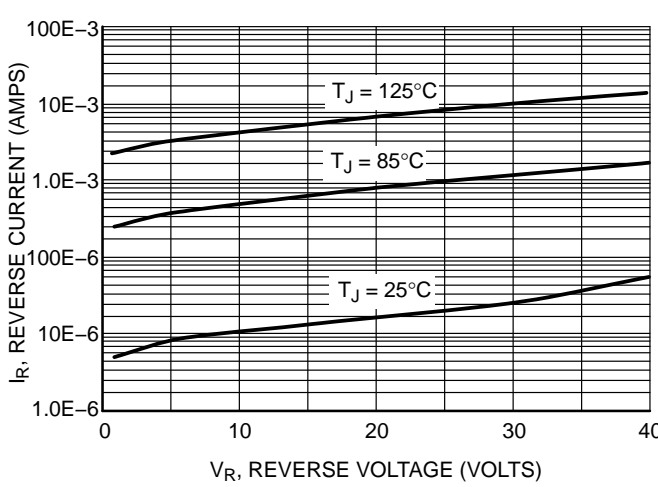

Figure 3. Typical Reverse Current

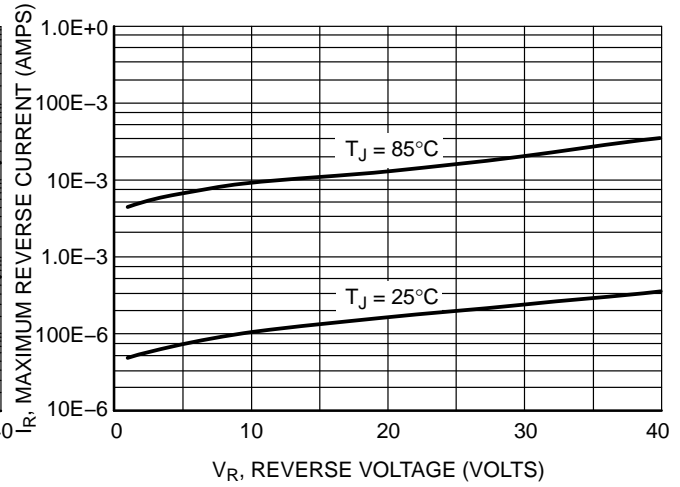

Figure 4. Maximum Reverse Current

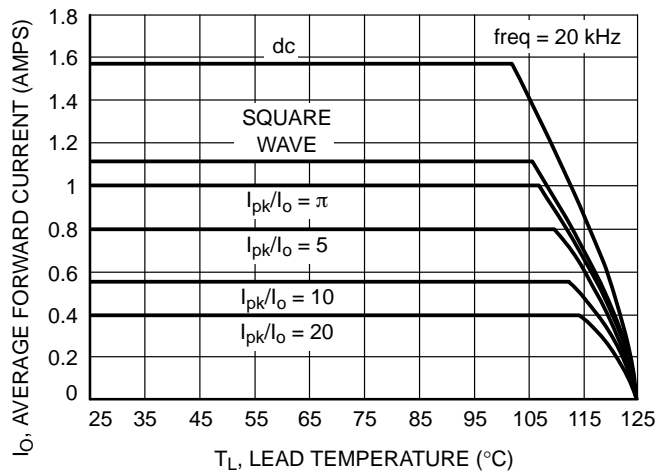

Figure 5. Current Derating

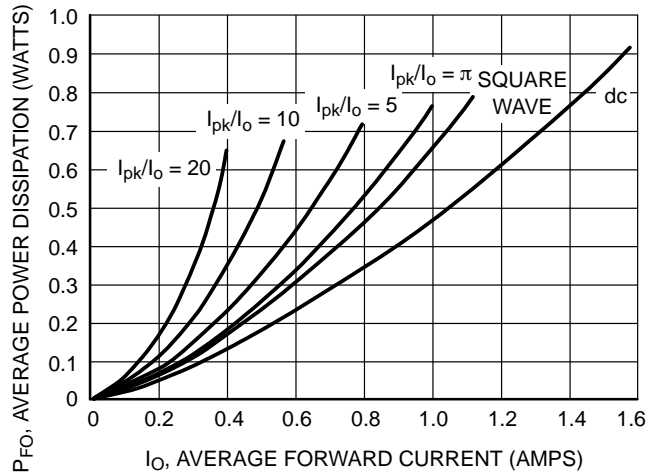

Figure 6. Forward Power Dissipation

MBR140SF, NRVB140SF

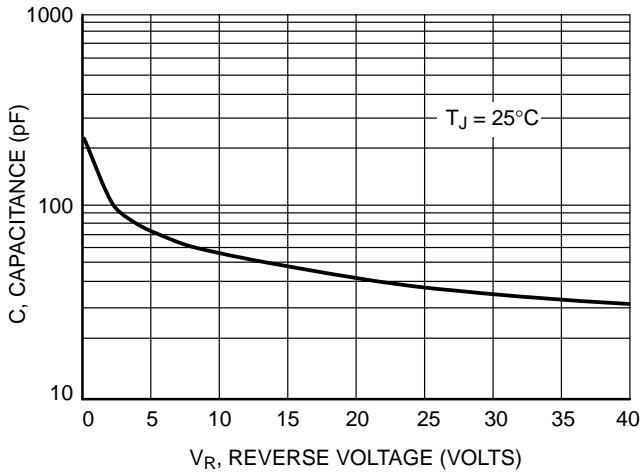

Figure 7. Capacitance

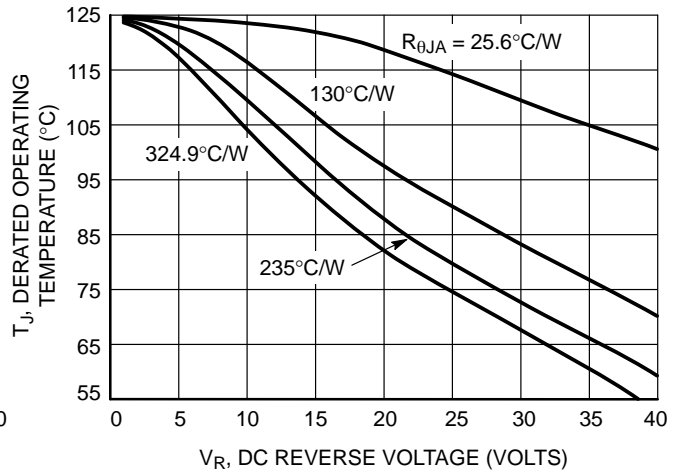

Figure 8. Typical Operating Temperature Derating*

* Reverse power dissipation and the possibility of thermal runaway must be considered when operating this device under any reverse voltage conditions. Calculations of T_J therefore must include forward and reverse power effects. The allowable operating T_J may be calculated from the equation: $T_J = T_{Jmax} - r(t)(P_f + P_r)$ where
 $r(t)$ = thermal impedance under given conditions,
 P_f = forward power dissipation, and
 P_r = reverse power dissipation

This graph displays the derated allowable T_J due to reverse bias under DC conditions only and is calculated as $T_J = T_{Jmax} - r(t)P_r$, where $r(t) = R_{thja}$. For other power applications further calculations must be performed.

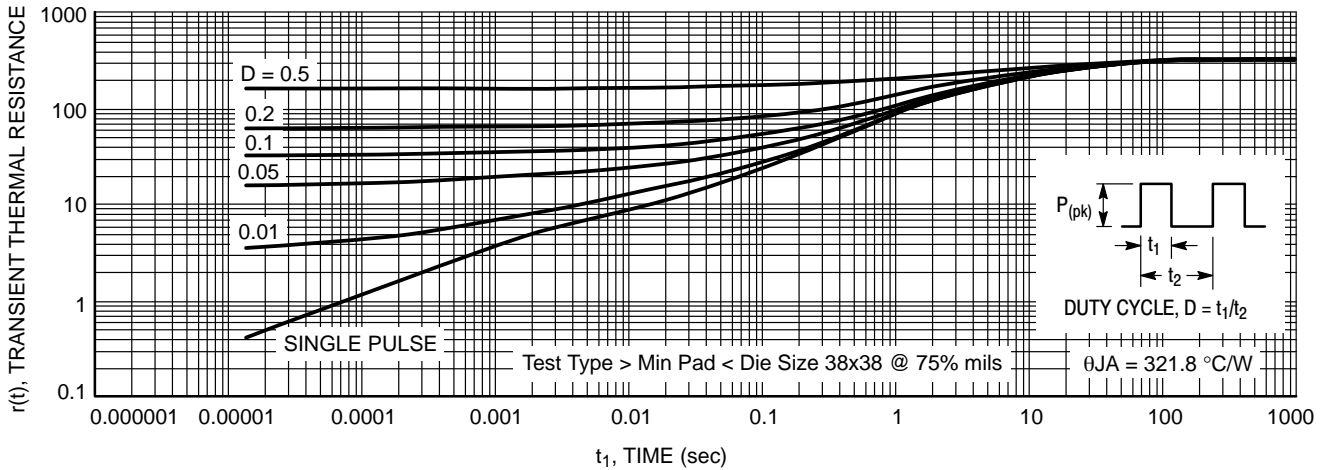
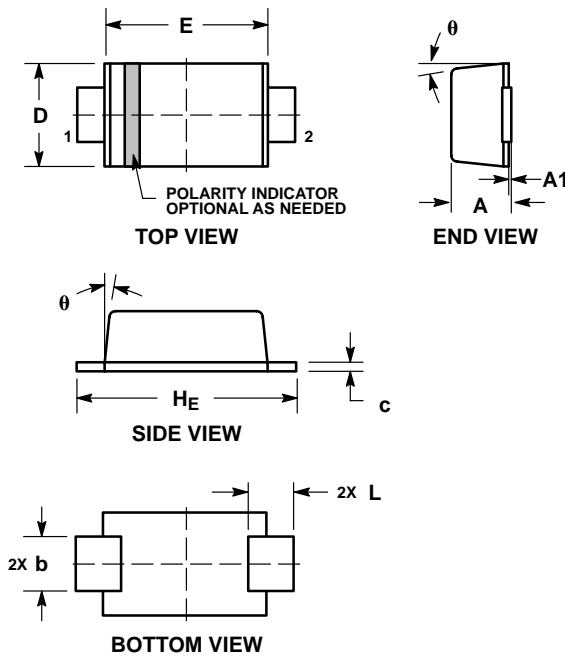

Figure 9. Thermal Response

MBR140SF, NRVB140SF

PACKAGE DIMENSIONS

SOD-123FL
CASE 498
ISSUE D



NOTES:

1. DIMENSIONING AND TOLERANCING PER ANSI Y14.5M, 1982.
2. CONTROLLING DIMENSION: MILLIMETER.
3. DIMENSIONS A AND B DO NOT INCLUDE MOLD FLASH.
4. DIMENSIONS D AND J ARE TO BE MEASURED ON FLAT SECTION OF THE LEAD: BETWEEN 0.10 AND 0.25 MM FROM THE LEAD TIP.

| DIM | MILLIMETERS | | | INCHES | | |
|-----|-------------|------|------|--------|-------|-------|
| | MIN | NOM | MAX | MIN | NOM | MAX |
| A | 0.90 | 0.95 | 0.98 | 0.035 | 0.037 | 0.039 |
| A1 | 0.00 | 0.05 | 0.10 | 0.000 | 0.002 | 0.004 |
| b | 0.70 | 0.90 | 1.10 | 0.028 | 0.035 | 0.043 |
| c | 0.10 | 0.15 | 0.20 | 0.004 | 0.006 | 0.008 |
| D | 1.50 | 1.65 | 1.80 | 0.059 | 0.065 | 0.071 |
| E | 2.50 | 2.70 | 2.90 | 0.098 | 0.106 | 0.114 |
| L | 0.55 | 0.75 | 0.95 | 0.022 | 0.030 | 0.037 |
| HE | 3.40 | 3.60 | 3.80 | 0.134 | 0.142 | 0.150 |
| θ | 0° | - | 8° | 0° | - | 8° |

RECOMMENDED SOLDERING FOOTPRINT*

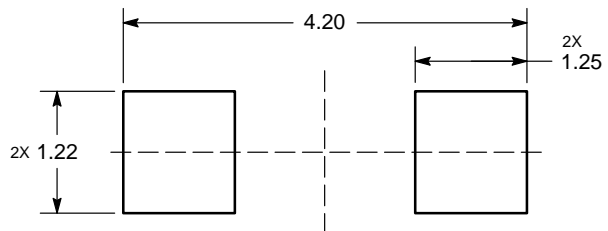

DIMENSIONS: MILLIMETERS

*For additional information on our Pb-Free strategy and soldering details, please download the ON Semiconductor Soldering and Mounting Techniques Reference Manual, SOLDERRM/D.

ON Semiconductor and the are registered trademarks of Semiconductor Components Industries, LLC (SCILLC) or its subsidiaries in the United States and/or other countries. SCILLC owns the rights to a number of patents, trademarks, copyrights, trade secrets, and other intellectual property. A listing of SCILLC's product/patent coverage may be accessed at www.onsemi.com/site/pdf/Patent-Marking.pdf. SCILLC reserves the right to make changes without further notice to any products herein. SCILLC makes no warranty, representation or guarantee regarding the suitability of its products for any particular purpose, nor does SCILLC assume any liability arising out of the application or use of any product or circuit, and specifically disclaims any and all liability, including without limitation special, consequential or incidental damages. "Typical" parameters which may be provided in SCILLC data sheets and/or specifications can and do vary in different applications and actual performance may vary over time. All operating parameters, including "Typicals" must be validated for each customer application by customer's technical experts. SCILLC does not convey any license under its patent rights nor the rights of others. SCILLC products are not designed, intended, or authorized for use as components in systems intended for surgical implant into the body, or other applications intended to support or sustain life, or for any other application in which the failure of the SCILLC product could create a situation where personal injury or death may occur. Should Buyer purchase or use SCILLC products for any such unintended or unauthorized application, Buyer shall indemnify and hold SCILLC and its officers, employees, subsidiaries, affiliates, and distributors harmless against all claims, costs, damages, and expenses, and reasonable attorney fees arising out of, directly or indirectly, any claim of personal injury or death associated with such unintended or unauthorized use, even if such claim alleges that SCILLC was negligent regarding the design or manufacture of the part. SCILLC is an Equal Opportunity/Affirmative Action Employer. This literature is subject to all applicable copyright laws and is not for resale in any manner.

PUBLICATION ORDERING INFORMATION

LITERATURE FULFILLMENT:
Literature Distribution Center for ON Semiconductor
P.O. Box 5163, Denver, Colorado 80217 USA
Phone: 303-675-2175 or 800-344-3860 Toll Free USA/Canada
Fax: 303-675-2176 or 800-344-3867 Toll Free USA/Canada
Email: orderlit@onsemi.com

N. American Technical Support: 800-282-9855 Toll Free
USA/Canada
Europe, Middle East and Africa Technical Support:
Phone: 421 33 790 2910
Japan Customer Focus Center
Phone: 81-3-5817-1050

ON Semiconductor Website: www.onsemi.com
Order Literature: <http://www.onsemi.com/orderlit>
For additional information, please contact your local Sales Representative

Mouser Electronics

Authorized Distributor

Click to View Pricing, Inventory, Delivery & Lifecycle Information:

[ON Semiconductor:](#)

[MBR140SFT1G](#) [MBR140SFT3G](#) [NRVB140SFT1G](#) [NRVB140SFT3G](#)