

# MBRA130LT3G, NRVBA130LT3G

## Surface Mount Schottky Power Rectifier

### SMA Power Surface Mount Package

This device employs the Schottky Barrier principle in a metal-to-silicon power rectifier. Features epitaxial construction with oxide passivation and metal overlay contact. Ideally suited for low voltage, high frequency switching power supplies; free wheeling diodes and polarity protection diodes.

#### Features

- Compact Package with J-Bend Leads Ideal for Automated Handling
- Highly Stable Oxide Passivated Junction
- Guardring for Over-Voltage Protection
- Low Forward Voltage Drop
- AEC-Q101 Qualified and PPAP Capable
- NRVBA Prefix for Automotive and Other Applications Requiring Unique Site and Control Change Requirements
- All Packages are Pb-Free\*

#### Mechanical Characteristics:

- Case: Molded Epoxy
- Epoxy Meets UL 94 V-0 @ 0.125 in
- Weight: 70 mg (approximately)
- Finish: All External Surfaces Corrosion Resistant and Terminal Leads are Readily Solderable
- Lead and Mounting Surface Temperature for Soldering Purposes: 260°C Max. for 10 Seconds
- Polarity: Cathode Lead Indicated by Either Notch in Plastic Body or Polarity Band
- Device Meets MSL1 Requirements
- ESD Ratings:
  - ◆ Machine Model = C (> 400 V)
  - ◆ Human Body Model = 3B (> 8000 V)



ON Semiconductor®

<http://onsemi.com>

**SCHOTTKY BARRIER  
RECTIFIER  
1.0 AMPERES, 30 VOLTS**



**SMA  
CASE 403D  
PLASTIC**

#### MARKING DIAGRAM



B1L3 = Specific Device Code  
A = Assembly Location  
Y = Year  
WW = Work Week  
▪ = Pb-Free Package

#### ORDERING INFORMATION

| Device       | Package          | Shipping†                 |
|--------------|------------------|---------------------------|
| MBRA130LT3G  | SMA<br>(Pb-Free) | 5,000 /<br>Tape & Reel ** |
| NRVBA130LT3G | SMA<br>(Pb-Free) | 5,000 /<br>Tape & Reel ** |

\*\* 12 mm Tape, 13" Reel

†For information on tape and reel specifications, including part orientation and tape sizes, please refer to our Tape and Reel Packaging Specification Brochure, BRD8011/D.

\*For additional information on our Pb-Free strategy and soldering details, please download the ON Semiconductor Soldering and Mounting Techniques Reference Manual, SOLDERRM/D.

# MBRA130LT3G, NRVBA130LT3G

## MAXIMUM RATINGS

| Rating  | Symbol                          | Value       | Unit             |
|---|---------------------------------|-------------|------------------|
| Peak Repetitive Reverse Voltage<br>Working Peak Reverse Voltage<br>DC Blocking Voltage                      | $V_{RRM}$<br>$V_{RWM}$<br>$V_R$ | 30          | V                |
| Average Rectified Forward Current<br>(At Rated $V_R$ , $T_C = 105^\circ\text{C}$ )                          | $I_O$                           | 1.0         | A                |
| Peak Repetitive Forward Current<br>(At Rated $V_R$ , Square Wave, 100 kHz, $T_C = 105^\circ\text{C}$ )      | $I_{FRM}$                       | 2.0         | A                |
| Non-Repetitive Peak Surge Current<br>(Surge Applied at Rated Load Conditions Halfwave, Single Phase, 60 Hz) | $I_{FSM}$                       | 25          | A                |
| Storage Temperature   | $T_{stg}$                       | -55 to +150 | $^\circ\text{C}$ |
| Operating Junction Temperature  | $T_J$                           | -55 to +125 | $^\circ\text{C}$ |
| Voltage Rate of Change, (Rated $V_R$ , $T_J = 25^\circ\text{C}$ )   | dv/dt                           | 10,000      | V/ $\mu\text{s}$ |

Stresses exceeding Maximum Ratings may damage the device. Maximum Ratings are stress ratings only. Functional operation above the Recommended Operating Conditions is not implied. Extended exposure to stresses above the Recommended Operating Conditions may affect device reliability.

## THERMAL CHARACTERISTICS

| Characteristic                                    | Symbol          | Value | Unit                      |
|---|-----------------|-------|---------------------------|
| Thermal Resistance — Junction-to-Lead (Note 1)    | $R_{\theta JL}$ | 35    | $^\circ\text{C}/\text{W}$ |
| Thermal Resistance — Junction-to-Ambient (Note 1) | $R_{\theta JA}$ | 86    |                           |

1. Mounted on 2" Square PC Board with 1" Square Total Pad Size, PC Board FR4.

## ELECTRICAL CHARACTERISTICS

| Characteristic  | Symbol | Value                    |                           | Unit  |
|---|--------|--------------------------|---------------------------|-------|
|   |        | $T_J = 25^\circ\text{C}$ | $T_J = 100^\circ\text{C}$ |       |
| Maximum Instantaneous Forward Voltage (Note 2)<br><br>( $I_F = 1.0\text{ A}$ ) see Figure 2<br>( $I_F = 2.0\text{ A}$ ) | $V_F$  | 0.41                     | 0.35                      | Volts |
|   |        | 0.47                     | 0.43                      |       |
| Maximum Instantaneous Reverse Current<br><br>( $V_R = 30\text{ V}$ ) see Figure 4<br>( $V_R = 15\text{ V}$ )            | $I_R$  | $T_J = 25^\circ\text{C}$ | $T_J = 100^\circ\text{C}$ | mA    |
|   |        | 1.0                      | 25                        |       |
|   |        | 0.4                      | 12                        |       |

2. Pulse Test: Pulse Width  $\leq 250\ \mu\text{s}$ , Duty Cycle  $\leq 2.0\%$ .

# MBRA130LT3G, NRVBA130LT3G

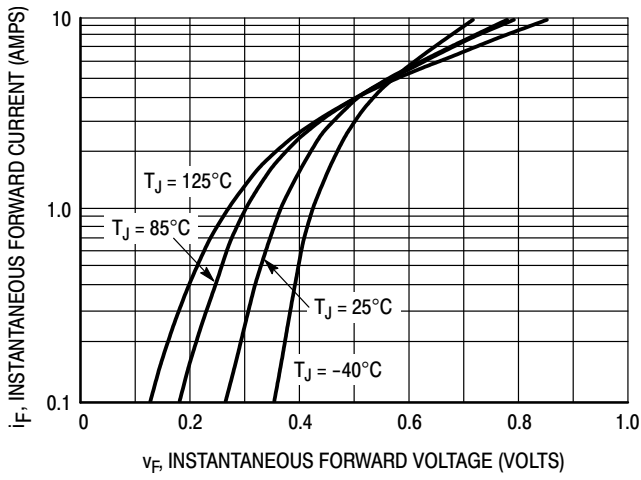

Figure 1. Typical Forward Voltage

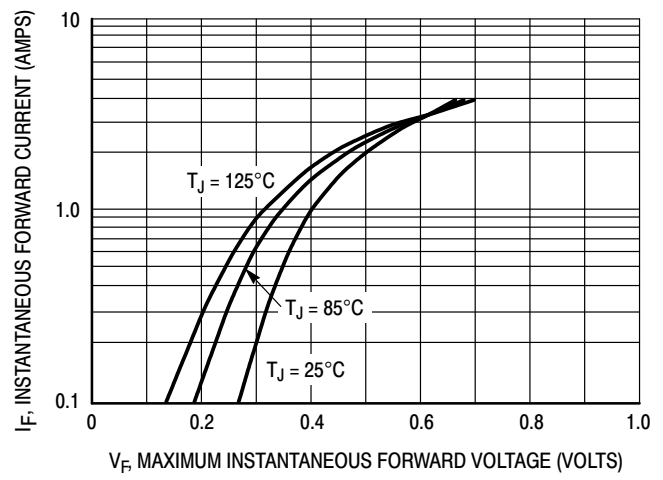

Figure 2. Maximum Forward Voltage

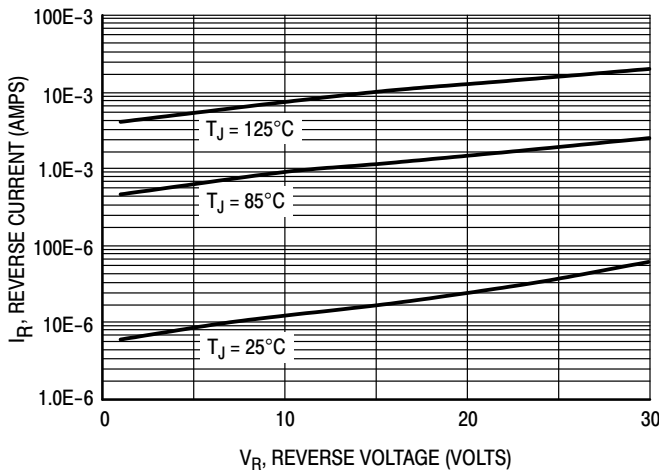

Figure 3. Typical Reverse Current

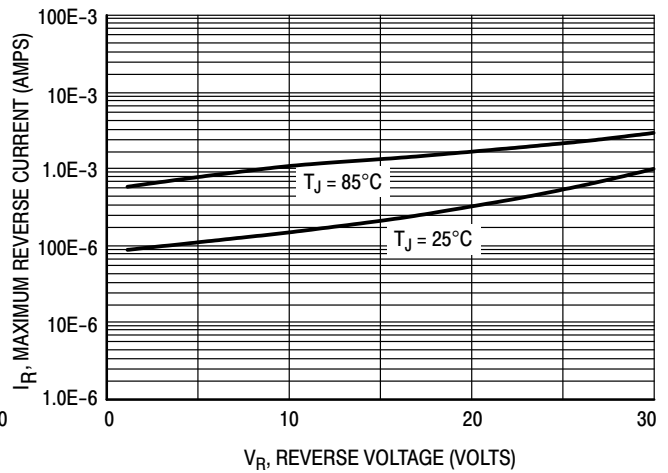

Figure 4. Maximum Reverse Current

# MBRA130LT3G, NRVBA130LT3G

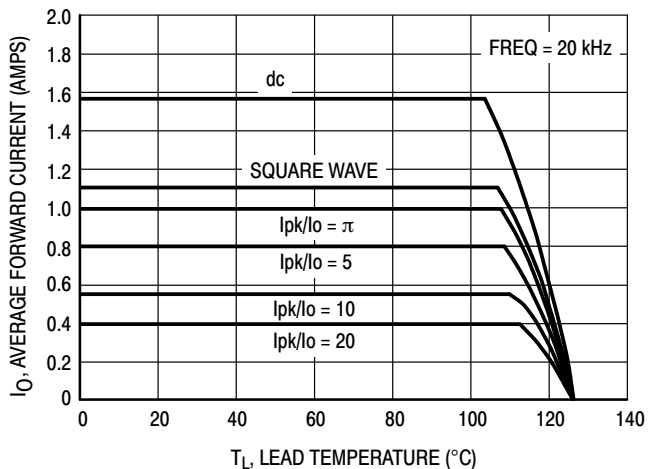

Figure 5. Current Derating

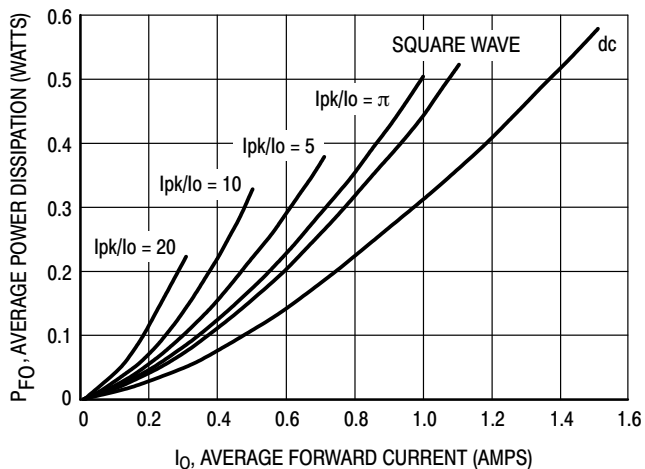

Figure 6. Forward Power Dissipation

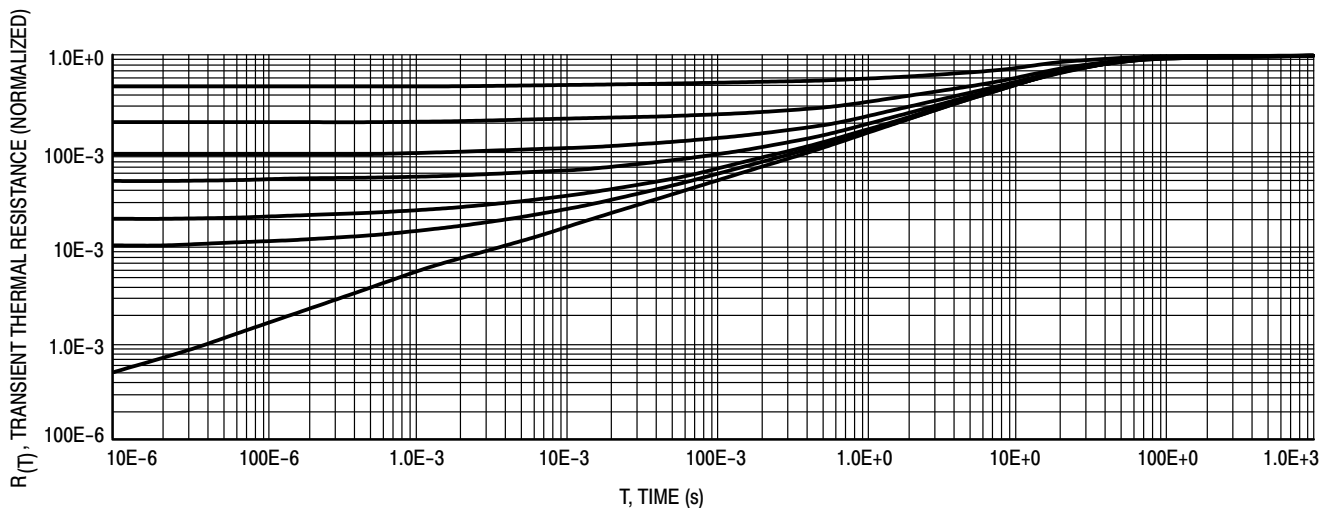

Figure 7. Thermal Response

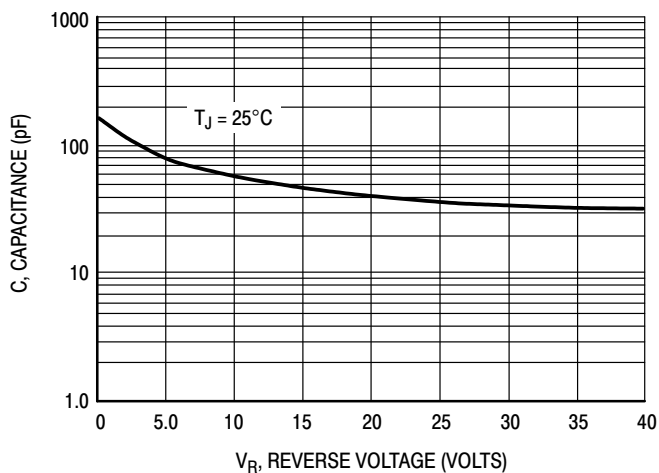
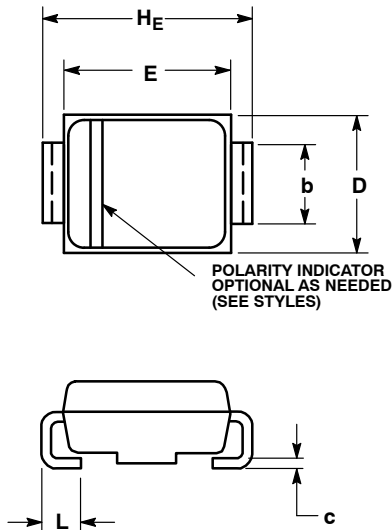

Figure 8. Capacitance

# MBRA130LT3G, NRVBA130LT3G

## PACKAGE DIMENSIONS

SMA  
CASE 403D-02  
ISSUE F



- NOTES:
1. DIMENSIONING AND TOLERANCING PER ANSI Y14.5M, 1982.
  2. CONTROLLING DIMENSION: INCH.
  3. 403D-01 OBSOLETE, NEW STANDARD IS 403D-02.

| DIM | MILLIMETERS |      |      | INCHES |       |       |
|-----|-------------|------|------|--------|-------|-------|
|     | MIN         | NOM  | MAX  | MIN    | NOM   | MAX   |
| A   | 1.97        | 2.10 | 2.20 | 0.078  | 0.083 | 0.087 |
| A1  | 0.05        | 0.10 | 0.15 | 0.002  | 0.004 | 0.006 |
| b   | 1.27        | 1.45 | 1.63 | 0.050  | 0.057 | 0.064 |
| c   | 0.15        | 0.28 | 0.41 | 0.006  | 0.011 | 0.016 |
| D   | 2.29        | 2.60 | 2.92 | 0.090  | 0.103 | 0.115 |
| E   | 4.06        | 4.32 | 4.57 | 0.160  | 0.170 | 0.180 |
| HE  | 4.83        | 5.21 | 5.59 | 0.190  | 0.205 | 0.220 |
| L   | 0.76        | 1.14 | 1.52 | 0.030  | 0.045 | 0.060 |

- STYLE 1:  
PIN 1. CATHODE (POLARITY BAND)  
2. ANODE

### SOLDERING FOOTPRINT\*

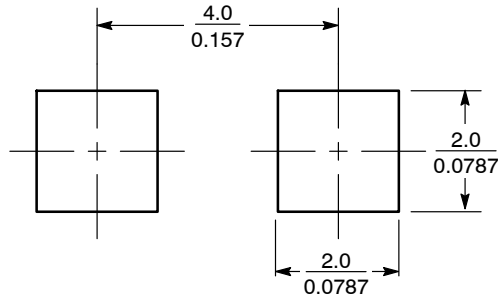

SCALE 8:1 (mm/inches)

\*For additional information on our Pb-Free strategy and soldering details, please download the ON Semiconductor Soldering and Mounting Techniques Reference Manual, SOLDERRM/D.

ON Semiconductor and are registered trademarks of Semiconductor Components Industries, LLC (SCILLC). SCILLC reserves the right to make changes without further notice to any products herein. SCILLC makes no warranty, representation or guarantee regarding the suitability of its products for any particular purpose, nor does SCILLC assume any liability arising out of the application or use of any product or circuit, and specifically disclaims any and all liability, including without limitation special, consequential or incidental damages. "Typical" parameters which may be provided in SCILLC data sheets and/or specifications can and do vary in different applications and actual performance may vary over time. All operating parameters, including "Typicals" must be validated for each customer application by customer's technical experts. SCILLC does not convey any license under its patent rights nor the rights of others. SCILLC products are not designed, intended, or authorized for use as components in systems intended for surgical implant into the body, or other applications intended to support or sustain life, or for any other application in which the failure of the SCILLC product could create a situation where personal injury or death may occur. Should Buyer purchase or use SCILLC products for any such unintended or unauthorized application, Buyer shall indemnify and hold SCILLC and its officers, employees, subsidiaries, affiliates, and distributors harmless against all claims, costs, damages, and expenses, and reasonable attorney fees arising out of, directly or indirectly, any claim of personal injury or death associated with such unintended or unauthorized use, even if such claim alleges that SCILLC was negligent regarding the design or manufacture of the part. SCILLC is an Equal Opportunity/Affirmative Action Employer. This literature is subject to all applicable copyright laws and is not for resale in any manner.

### PUBLICATION ORDERING INFORMATION

**LITERATURE FULFILLMENT:**  
Literature Distribution Center for ON Semiconductor  
P.O. Box 5163, Denver, Colorado 80217 USA  
**Phone:** 303-675-2175 or 800-344-3860 Toll Free USA/Canada  
**Fax:** 303-675-2176 or 800-344-3867 Toll Free USA/Canada  
**Email:** orderlit@onsemi.com

**N. American Technical Support:** 800-282-9855 Toll Free  
USA/Canada  
**Europe, Middle East and Africa Technical Support:**  
Phone: 421 33 790 2910  
**Japan Customer Focus Center**  
Phone: 81-3-5817-1050

**ON Semiconductor Website:** [www.onsemi.com](http://www.onsemi.com)  
**Order Literature:** <http://www.onsemi.com/orderlit>  
For additional information, please contact your local Sales Representative

# Mouser Electronics

Authorized Distributor

Click to View Pricing, Inventory, Delivery & Lifecycle Information:

[ON Semiconductor:](#)

[MBRA130LT3G](#) [NRVBA130LT3G](#)