



MCH6321

P-Channel Power MOSFET -20V, -4A, 83mΩ, Single MCPH6

ON Semiconductor®

<http://onsemi.com>

Features

- 1.8V drive
- Protection diode in

Specifications

Absolute Maximum Ratings at Ta=25°C

Parameter	Symbol	Conditions	Ratings	Unit
Drain-to-Source Voltage	V _{DSS}		-20	V
Gate-to-Source Voltage	V _{GSS}		±10	V
Drain Current (DC)	I _D		-4	A
Drain Current (Pulse)	I _{DP}	PW≤10μs, duty cycle≤1%	-16	A
Allowable Power Dissipation	P _D	When mounted on ceramic substrate (1200mm ² ×0.8mm)	1.5	W
Channel Temperature	T _{ch}		150	°C
Storage Temperature	T _{stg}		-55 to +150	°C

Stresses exceeding those listed in the Maximum Ratings table may damage the device. If any of these limits are exceeded, device functionality should not be assumed, damage may occur and reliability may be affected.

Package Dimensions

unit : mm (typ)

7022A-009

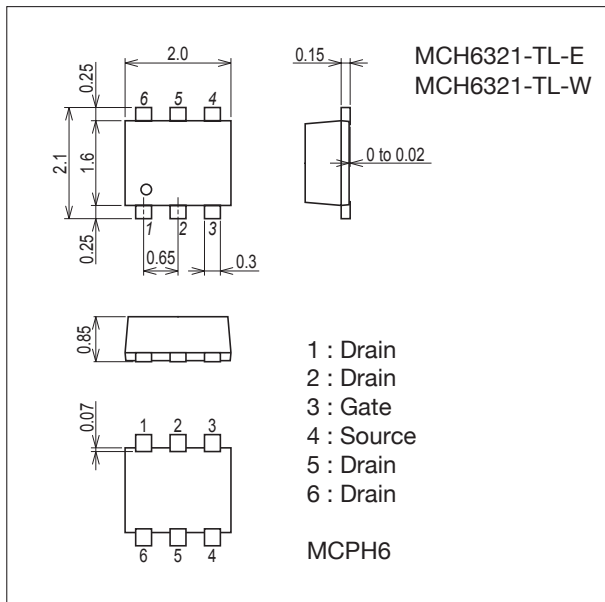

Product & Package Information

- Package : MCPH6
- JEITA, JEDEC : SC-88, SC-70-6, SOT-363
- Minimum Packing Quantity : 3,000 pcs./reel

Packing Type : TL

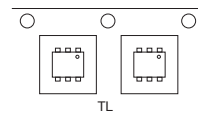

Marking

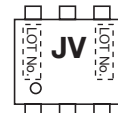

Electrical Connection

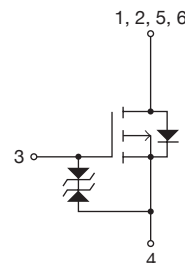

ORDERING INFORMATION

See detailed ordering and shipping information on page 2 of this data sheet.

MCH6321

Electrical Characteristics at Ta=25°C

Parameter	Symbol	Conditions	Ratings			Unit
			min	typ	max	
Drain-to-Source Breakdown Voltage	$V_{(BR)DSS}$	$I_D = -1mA, V_{GS} = 0V$	-20			V
Zero-Gate Voltage Drain Current	I_{DSS}	$V_{DS} = -20V, V_{GS} = 0V$			-1	μA
Gate-to-Source Leakage Current	I_{GSS}	$V_{GS} = \pm 8V, V_{DS} = 0V$			± 10	μA
Cutoff Voltage	$V_{GS(off)}$	$V_{DS} = -10V, I_D = -1mA$	-0.4		-1.3	V
Forward Transfer Admittance	$ y_{fs} $	$V_{DS} = -10V, I_D = -2A$	2.5	4.3		S
Static Drain-to-Source On-State Resistance	$R_{DS(on)1}$	$I_D = -2A, V_{GS} = -4.5V$		63	83	$m\Omega$
	$R_{DS(on)2}$	$I_D = -1A, V_{GS} = -2.5V$		88	125	$m\Omega$
	$R_{DS(on)3}$	$I_D = -0.2A, V_{GS} = -1.8V$		130	200	$m\Omega$
Input Capacitance	C_{iss}			375		pF
Output Capacitance	C_{oss}	$V_{DS} = -10V, f = 1MHz$		77		pF
Reverse Transfer Capacitance	C_{rss}			58		pF
Turn-ON Delay Time	$t_{d(on)}$	See specified Test Circuit.		8.1		ns
Rise Time	t_r			31		ns
Turn-OFF Delay Time	$t_{d(off)}$			40		ns
Fall Time	t_f			39		ns
Total Gate Charge	Q_g				4.6	
Gate-to-Source Charge	Q_{gs}	$V_{DS} = -10V, V_{GS} = -4.5V, I_D = -4A$		0.8		nC
Gate-to-Drain "Miller" Charge	Q_{gd}			1.3		nC
Diode Forward Voltage	V_{SD}	$I_S = -4A, V_{GS} = 0V$		-0.86	-1.2	V

Product parametric performance is indicated in the Electrical Characteristics for the listed test conditions, unless otherwise noted. Product performance may not be indicated by the Electrical Characteristics if operated under different conditions.

Switching Time Test Circuit

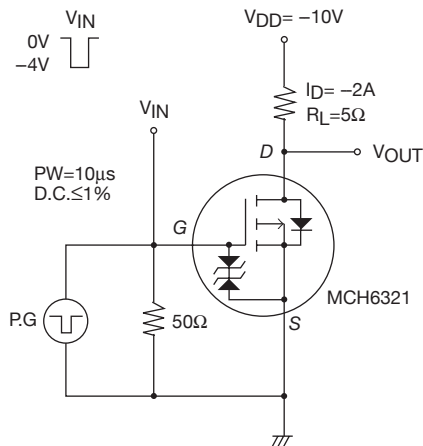

Ordering Information

Device	Package	Shipping	memo
MCH6321-TL-E	MCPH6	3,000pcs./reel	Pb-Free
MCH6321-TL-W			Pb-Free and Halogen Free

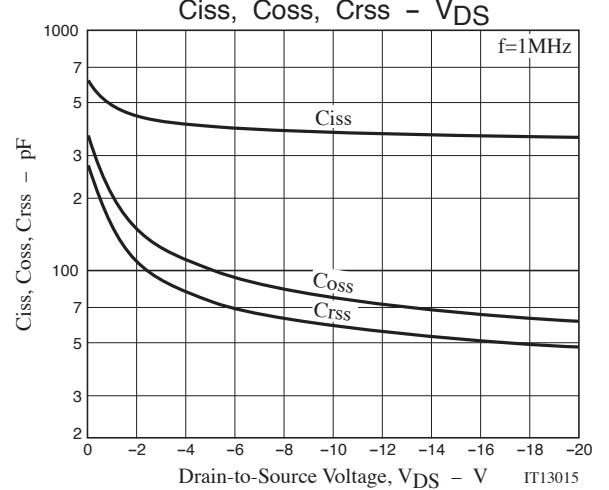
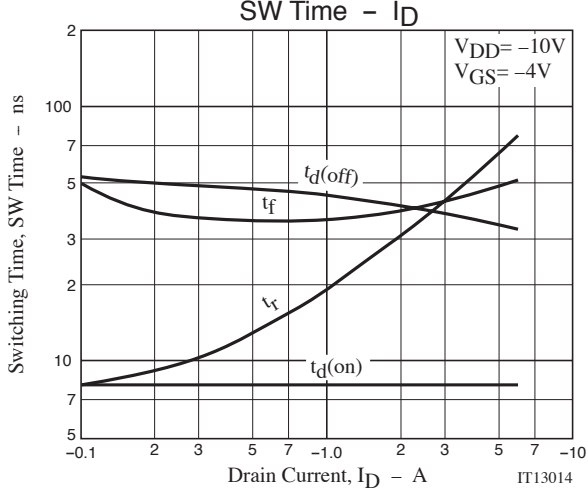
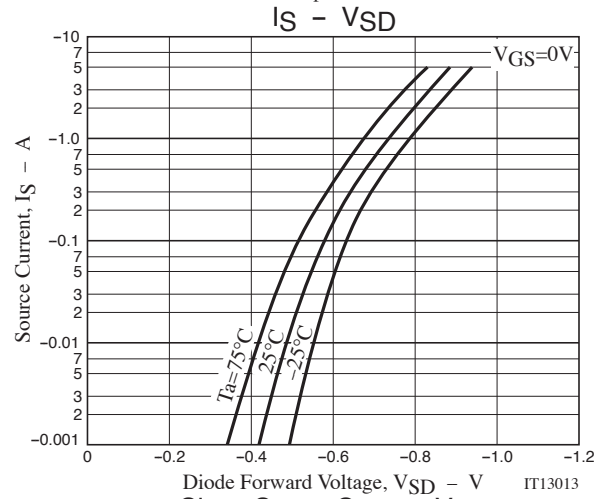
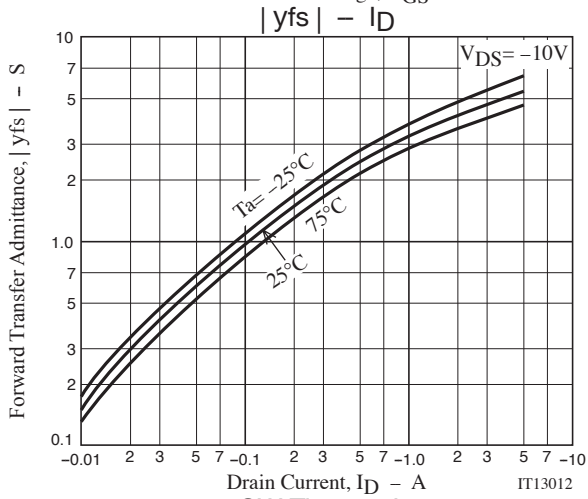
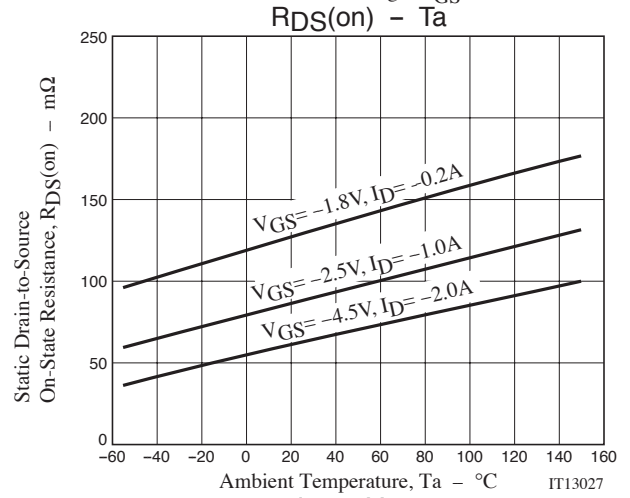
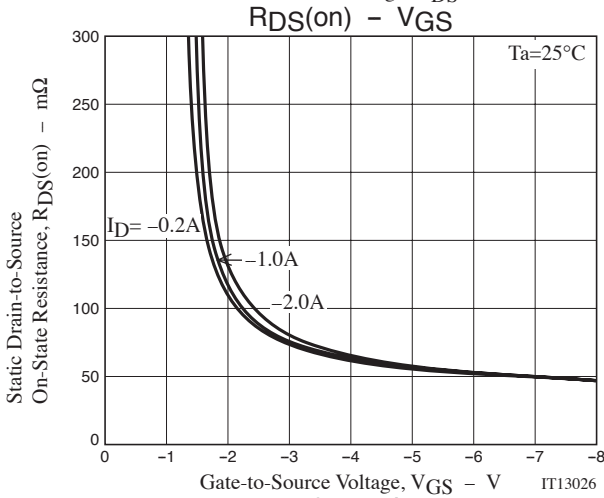
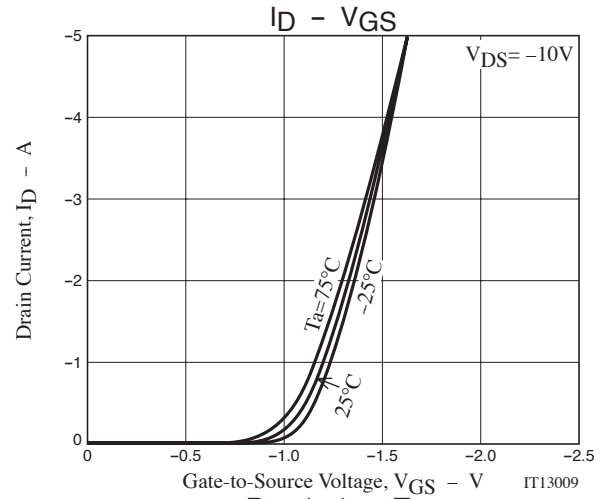
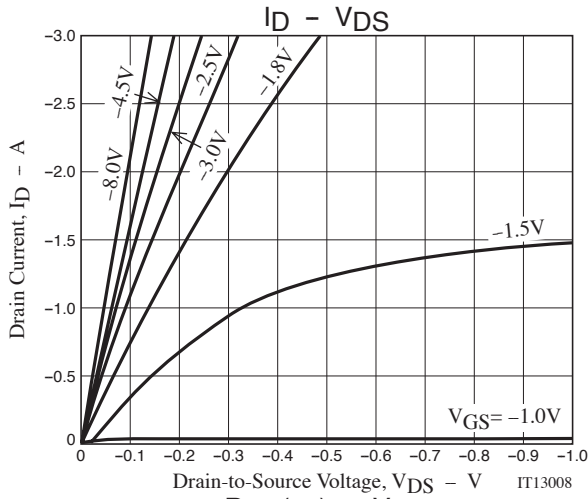

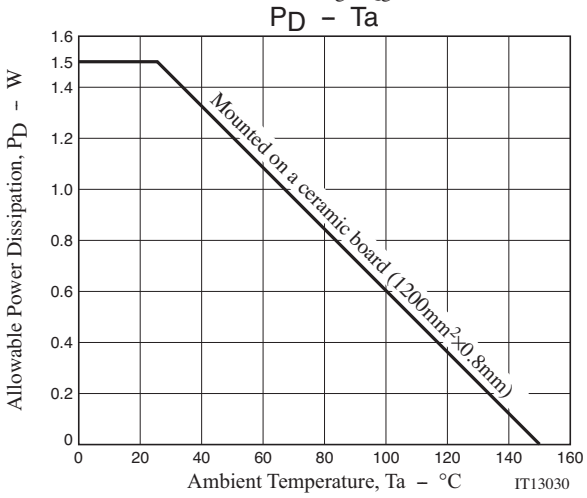
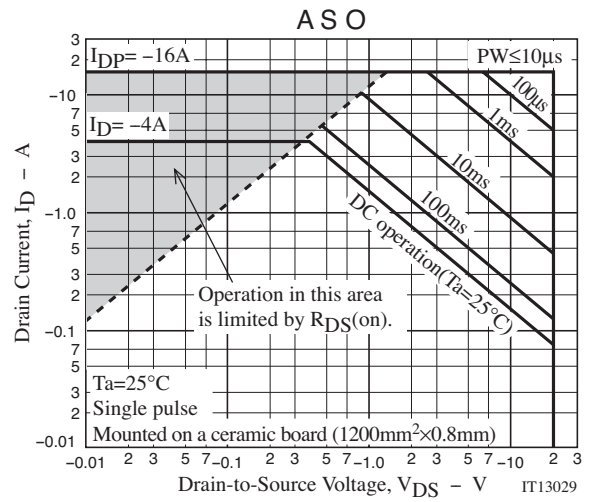
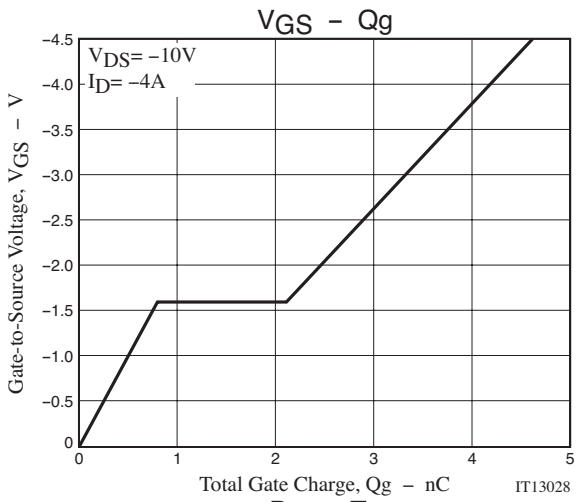

MCH6321

Outline Drawing

MCH6321-TL-E, MCH6321-TL-W

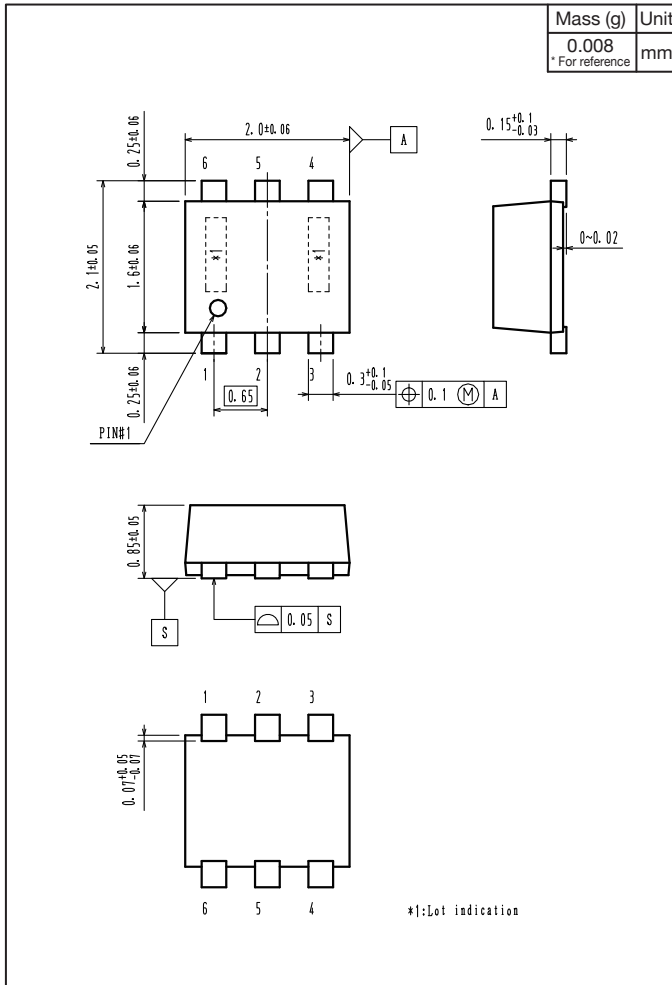

Land Pattern Example

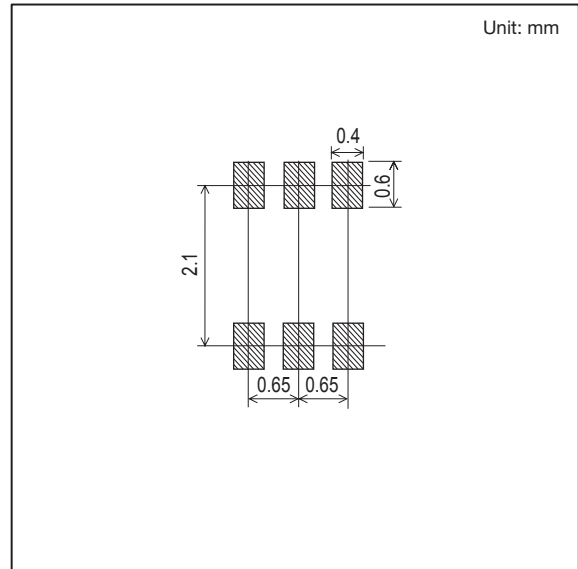

Note on usage : Since the MCH6321 is a MOSFET product, please avoid using this device in the vicinity of highly charged objects.

ON Semiconductor and the ON logo are registered trademarks of Semiconductor Components Industries, LLC (SCILLC). SCILLC owns the rights to a number of patents, trademarks, copyrights, trade secrets, and other intellectual property. A listing of SCILLC's product/patent coverage may be accessed at www.onsemi.com/site/pdf/Patent-Marking.pdf. SCILLC reserves the right to make changes without further notice to any products herein. SCILLC makes no warranty, representation or guarantee regarding the suitability of its products for any particular purpose, nor does SCILLC assume any liability arising out of the application or use of any product or circuit, and specifically disclaims any and all liability, including without limitation special, consequential or incidental damages. "Typical" parameters which may be provided in SCILLC data sheets and/or specifications can and do vary in different applications and actual performance may vary over time. All operating parameters, including "Typicals" must be validated for each customer application by customer's technical experts. SCILLC does not convey any license under its patent rights nor the rights of others. SCILLC products are not designed, intended, or authorized for use as components in systems intended for surgical implant into the body, or other applications intended to support or sustain life, or for any other application in which the failure of the SCILLC product could create a situation where personal injury or death may occur. Should Buyer purchase or use SCILLC products for any such unintended or unauthorized application, Buyer shall indemnify and hold SCILLC and its officers, employees, subsidiaries, affiliates, and distributors harmless against all claims, costs, damages, and expenses, and reasonable attorney fees arising out of, directly or indirectly, any claim of personal injury or death associated with such unintended or unauthorized use, even if such claim alleges that SCILLC was negligent regarding the design or manufacture of the part. SCILLC is an Equal Opportunity/Affirmative Action Employer. This literature is subject to all applicable copyright laws and is not for resale in any manner.

Mouser Electronics

Authorized Distributor

Click to View Pricing, Inventory, Delivery & Lifecycle Information:

[ON Semiconductor:](#)

[MCH6321-TL-W](#)