

# MJE13007

## Switch-mode NPN Bipolar Power Transistor

### For Switching Power Supply Applications

The MJE13007 is designed for high-voltage, high-speed power switching inductive circuits where fall time is critical. It is particularly suited for 115 and 220 V switch-mode applications such as Switching Regulators, Inverters, Motor Controls, Solenoid/Relay drivers and Deflection circuits.

#### Features

- SOA and Switching Applications Information
- Standard TO-220
- These Devices are Pb-Free and are RoHS Compliant\*
- Complementary to the MJE5850 through MJE5852 Series

#### MAXIMUM RATINGS

Rating	Symbol	Value	Unit
Collector-Emitter Sustaining Voltage	$V_{CEO}$	400	Vdc
Collector-Base Breakdown Voltage	$V_{CES}$	700	Vdc
Emitter-Base Voltage	$V_{EBO}$	9.0	Vdc
Collector Current – Continuous	$I_C$	8.0	Adc
Collector Current – Peak (Note 1)	$I_{CM}$	16	Adc
Base Current – Continuous	$I_B$	4.0	Adc
Base Current – Peak (Note 1)	$I_{BM}$	8.0	Adc
Emitter Current – Continuous	$I_E$	12	Adc
Emitter Current – Peak (Note 1)	$I_{EM}$	24	Adc
Total Device Dissipation @ $T_C = 25^\circ\text{C}$ Derate above $25^\circ\text{C}$	$P_D$	80 0.64	W W/ $^\circ\text{C}$
Operating and Storage Temperature	$T_J, T_{stg}$	-65 to 150	$^\circ\text{C}$

Stresses exceeding those listed in the Maximum Ratings table may damage the device. If any of these limits are exceeded, device functionality should not be assumed, damage may occur and reliability may be affected.

1. Pulse Test: Pulse Width = 5 ms, Duty Cycle  $\leq 10\%$ .

#### THERMAL CHARACTERISTICS

Characteristics	Symbol	Max	Unit
Thermal Resistance, Junction-to-Case	$R_{\theta JC}$	1.56	$^\circ\text{C}/\text{W}$
Thermal Resistance, Junction-to-Ambient	$R_{\theta JA}$	62.5	$^\circ\text{C}/\text{W}$
Maximum Lead Temperature for Soldering Purposes 1/8" from Case for 5 Seconds	$T_L$	260	$^\circ\text{C}$

\*Measurement made with thermocouple contacting the bottom insulated mounting surface of the package (in a location beneath the die), the device mounted on a heatsink with thermal grease applied at a mounting torque of 6 to 8lbs.

\*For additional information on our Pb-Free strategy and soldering details, please download the ON Semiconductor Soldering and Mounting Techniques Reference Manual, SOLDERRM/D.



ON Semiconductor®

[www.onsemi.com](http://www.onsemi.com)

**POWER TRANSISTOR  
8.0 AMPERES  
400 VOLTS – 80 WATTS**

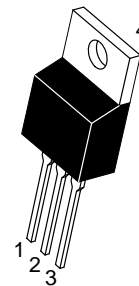
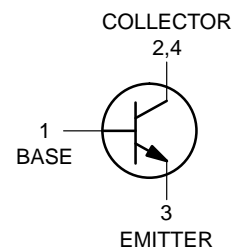

TO-220AB  
CASE 221A-09  
STYLE 1

#### MARKING DIAGRAM

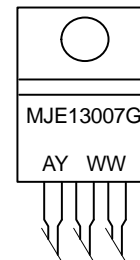

A = Assembly Location  
Y = Year  
WW = Work Week  
G = Pb-Free Package

#### ORDERING INFORMATION

Device	Package	Shipping
MJE13007G	TO-220 (Pb-Free)	50 Units / Rail

# MJE13007

## ELECTRICAL CHARACTERISTICS (T<sub>C</sub> = 25°C unless otherwise noted)

Characteristic	Symbol	Min	Typ	Max	Unit
<b>OFF CHARACTERISTICS</b> (Note 2)					
Collector–Emitter Sustaining Voltage (I <sub>C</sub> = 10 mA, I <sub>B</sub> = 0)	V <sub>CEO(sus)</sub>	400	–	–	Vdc
Collector Cutoff Current (V <sub>CE</sub> = 700 Vdc) (V <sub>CE</sub> = 700 Vdc, T <sub>C</sub> = 125°C)	I <sub>CES</sub>	–	–	0.1 1.0	mAdc
Emitter Cutoff Current (V <sub>EB</sub> = 9.0 Vdc, I <sub>C</sub> = 0)	I <sub>EBO</sub>	–	–	100	μAdc

## SECOND BREAKDOWN

Second Breakdown Collector Current with Base Forward Biased	I <sub>S/b</sub>	See Figure 6			
Clamped Inductive SOA with Base Reverse Biased	–	See Figure 7			

## ON CHARACTERISTICS

 (Note 2)

DC Current Gain (I <sub>C</sub> = 2.0 Adc, V <sub>CE</sub> = 5.0 Vdc) (I <sub>C</sub> = 5.0 Adc, V <sub>CE</sub> = 5.0 Vdc)	h <sub>FE</sub>	8.0 5.0	– –	40 30	–
Collector–Emitter Saturation Voltage (I <sub>C</sub> = 2.0 Adc, I <sub>B</sub> = 0.4 Adc) (I <sub>C</sub> = 5.0 Adc, I <sub>B</sub> = 1.0 Adc) (I <sub>C</sub> = 8.0 Adc, I <sub>B</sub> = 2.0 Adc) (I <sub>C</sub> = 5.0 Adc, I <sub>B</sub> = 1.0 Adc, T <sub>C</sub> = 100°C)	V <sub>CE(sat)</sub>	– – – –	– – – –	1.0 2.0 3.0 3.0	Vdc
Base–Emitter Saturation Voltage (I <sub>C</sub> = 2.0 Adc, I <sub>B</sub> = 0.4 Adc) (I <sub>C</sub> = 5.0 Adc, I <sub>B</sub> = 1.0 Adc) (I <sub>C</sub> = 5.0 Adc, I <sub>B</sub> = 1.0 Adc, T <sub>C</sub> = 100°C)	V <sub>BE(sat)</sub>	– – –	– – –	1.2 1.6 1.5	Vdc

## DYNAMIC CHARACTERISTICS

Current–Gain – Bandwidth Product (I <sub>C</sub> = 500 mAdc, V <sub>CE</sub> = 10 Vdc, f = 1.0 MHz)	f <sub>T</sub>	4.0	14	–	MHz
Output Capacitance (V <sub>CB</sub> = 10 Vdc, I <sub>E</sub> = 0, f = 0.1 MHz)	C <sub>ob</sub>	–	80	–	pF

## SWITCHING CHARACTERISTICS

<b>Resistive Load</b> (Table 1)							
Delay Time	(V <sub>CC</sub> = 125 Vdc, I <sub>C</sub> = 5.0 A, I <sub>B1</sub> = I <sub>B2</sub> = 1.0 A, t <sub>p</sub> = 25 μs, Duty Cycle ≤ 1.0%)	t <sub>d</sub>	–	0.025	0.1	μs	
Rise Time		t <sub>r</sub>	–	0.5	1.5		
Storage Time		t <sub>s</sub>	–	1.8	3.0		
Fall Time		t <sub>f</sub>	–	0.23	0.7		
<b>Inductive Load, Clamped</b> (Table 1)							
Voltage Storage Time	V <sub>CC</sub> = 15 Vdc, I <sub>C</sub> = 5.0 A V <sub>clamp</sub> = 300 Vdc	T <sub>C</sub> = 25°C T <sub>C</sub> = 100°C	t <sub>sv</sub>	– –	1.2 1.6	2.0 3.0	μs
Crossover Time	I <sub>B(on)</sub> = 1.0 A, I <sub>B(off)</sub> = 2.5 A L <sub>C</sub> = 200 μH	T <sub>C</sub> = 25°C T <sub>C</sub> = 100°C	t <sub>c</sub>	– –	0.15 0.21	0.30 0.50	μs
Fall Time		T <sub>C</sub> = 25°C T <sub>C</sub> = 100°C	t <sub>fi</sub>	– –	0.04 0.10	0.12 0.20	μs

Product parametric performance is indicated in the Electrical Characteristics for the listed test conditions, unless otherwise noted. Product performance may not be indicated by the Electrical Characteristics if operated under different conditions.

2. Pulse Test: Pulse Width ≤ 300 μs, Duty Cycle ≤ 2.0%.

TYPICAL CHARACTERISTICS

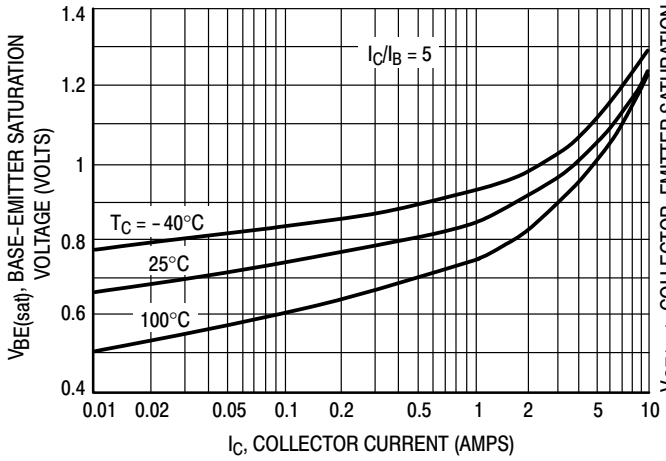

Figure 1. Base-Emitter Saturation Voltage

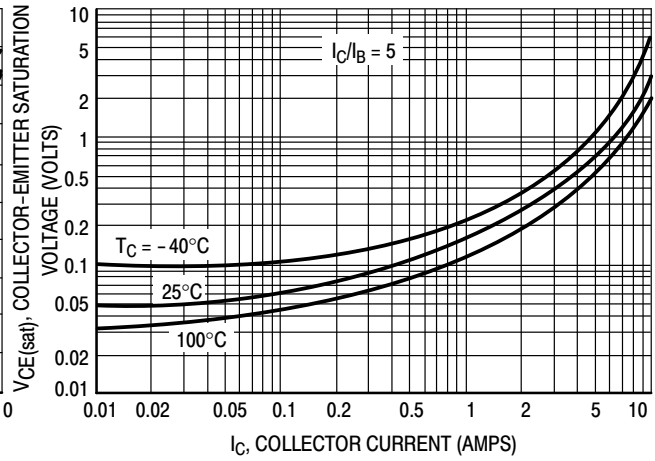

Figure 2. Collector-Emitter Saturation Voltage

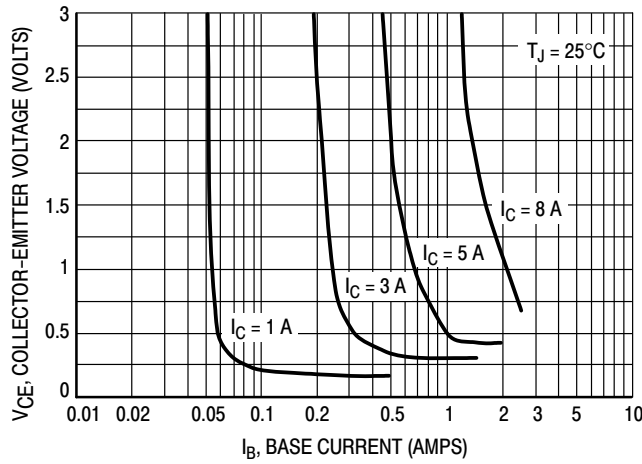

Figure 3. Collector Saturation Region

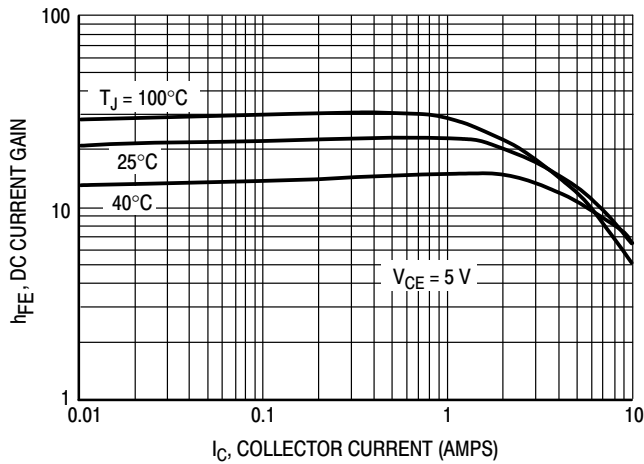

Figure 4. DC Current Gain

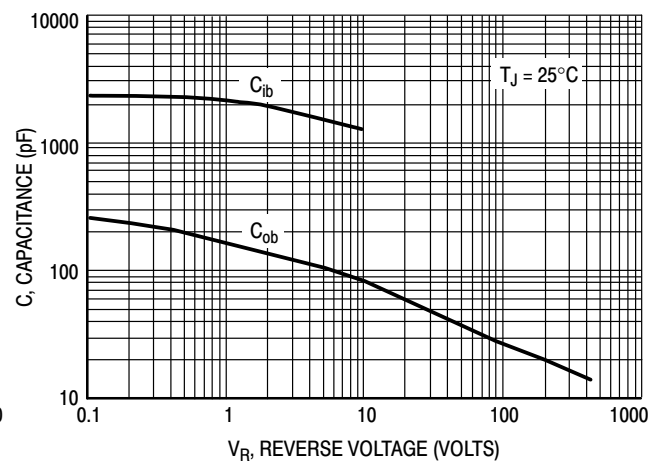

Figure 5. Capacitance

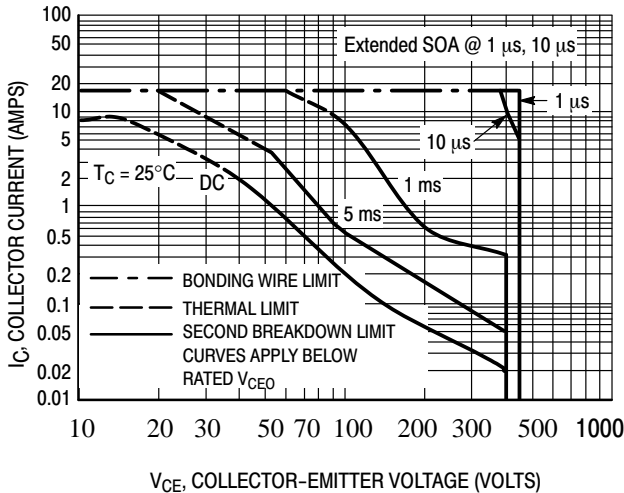

Figure 6. Maximum Forward Bias Safe Operating Area

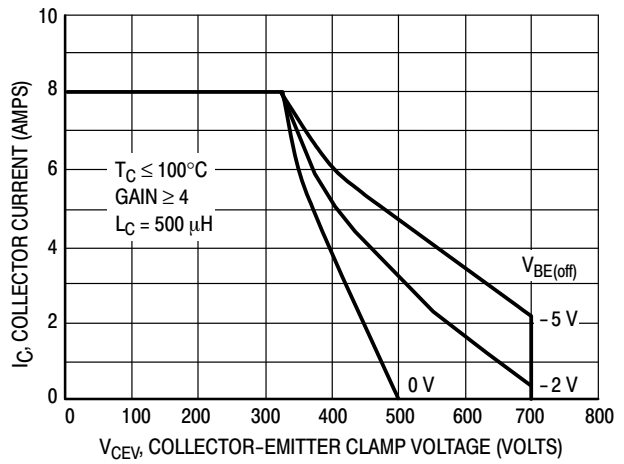

Figure 7. Maximum Reverse Bias Switching Safe Operating Area

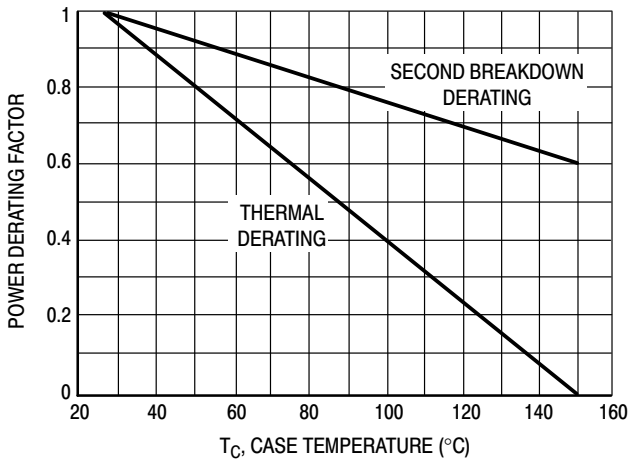

Figure 8. Forward Bias Power Derating

There are two limitations on the power handling ability of a transistor: average junction temperature and second breakdown. Safe operating area curves indicate  $I_C - V_{CE}$  limits of the transistor that must be observed for reliable operation; i.e., the transistor must not be subjected to greater dissipation than the curves indicate.

The data of Figure 6 is based on  $T_C = 25^\circ\text{C}$ ;  $T_{J(pk)}$  is variable depending on power level. Second breakdown pulse limits are valid for duty cycles to 10% but must be derated when  $T_C \geq 25^\circ\text{C}$ . Second breakdown limitations do not derate the same as thermal limitations. Allowable current at the voltages shown on Figure 6 may be found at any case temperature by using the appropriate curve on Figure 8.

At high case temperatures, thermal limitations will reduce the power that can be handled to values less than the limitations imposed by second breakdown.

Use of reverse biased safe operating area data (Figure 7) is discussed in the applications information section.

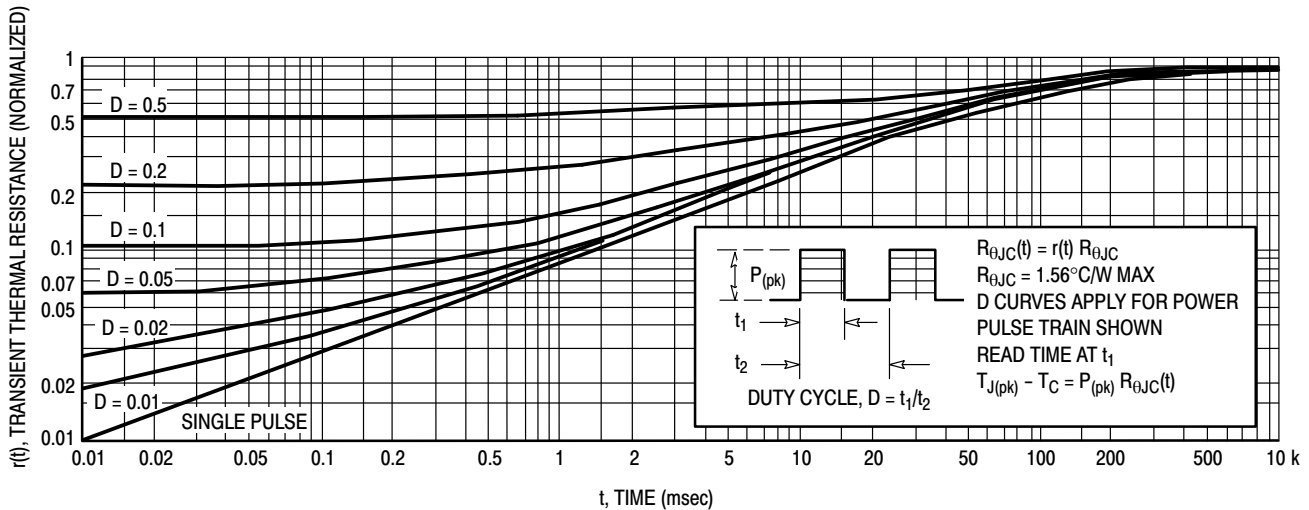

Figure 9. Typical Thermal Response for MJE13007

**SPECIFICATION INFORMATION FOR SWITCHMODE APPLICATIONS****INTRODUCTION**

The primary considerations when selecting a power transistor for SWITCHMODE applications are voltage and current ratings, switching speed, and energy handling capability. In this section, these specifications will be discussed and related to the circuit examples illustrated in Table 2. (Note 1)

**VOLTAGE REQUIREMENTS**

Both blocking voltage and sustaining voltage are important in SWITCHMODE applications.

Circuits B and C in Table 2 illustrate applications that require high blocking voltage capability. In both circuits the switching transistor is subjected to voltages substantially higher than  $V_{CC}$  after the device is completely off (see load line diagrams at  $I_C = I_{leakage} \approx 0$  in Table 2). The blocking capability at this point depends on the base to emitter conditions and the device junction temperature. Since the highest device capability occurs when the base to emitter junction is reverse biased ( $V_{CEV}$ ), this is the recommended and specified use condition. Maximum  $I_{CEV}$  at rated  $V_{CEV}$  is specified at a relatively low reverse bias (1.5 Volts) both

at 25°C and 100°C. Increasing the reverse bias will give some improvement in device blocking capability.

The sustaining or active region voltage requirements in switching applications occur during turn-on and turn-off. If the load contains a significant capacitive component, high current and voltage can exist simultaneously during turn-on and the pulsed forward bias SOA curves (Figure 6) are the proper design limits.

For inductive loads, high voltage and current must be sustained simultaneously during turn-off, in most cases, with the base to emitter junction reverse biased. Under these conditions the collector voltage must be held to a safe level at or below a specific value of collector current. This can be accomplished by several means such as active clamping, RC snubbing, load line shaping, etc. The safe level for these devices is specified as a Reverse Bias Safe Operating Area (Figure 7) which represents voltage-current conditions that can be sustained during reverse biased turn-off. This rating is verified under clamped conditions so that the device is never subjected to an avalanche mode.

NOTE: 1. For detailed information on specific switching applications, see ON Semiconductor Application Note AN719, AN873, AN875, AN951.

Table 1. Test Conditions For Dynamic Performance

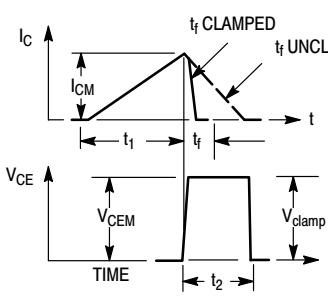
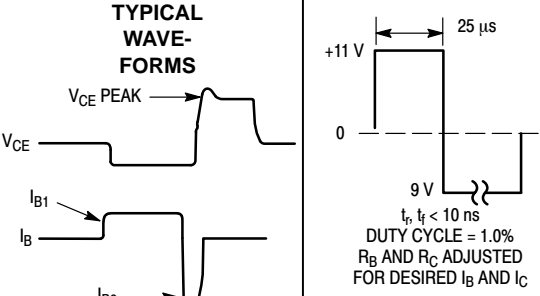
TEST CIRCUITS	REVERSE BIAS SAFE OPERATING AREA AND INDUCTIVE SWITCHING	RESISTIVE SWITCHING						
CIRCUIT VALUES	<table border="1"> <thead> <tr> <th><math>V_{(BR)CEO(sus)}</math></th> <th>Inductive Switching</th> <th>RBSOA</th> </tr> </thead> <tbody> <tr> <td>L = 10 mH <math>R_{B2} = 8</math> <math>V_{CC} = 20</math> Volts <math>I_{C(pk)} = 100</math> mA</td> <td>L = 200 mH <math>R_{B2} = 0</math> <math>V_{CC} = 15</math> Volts <math>R_{B1}</math> selected for desired <math>I_{B1}</math></td> <td>L = 500 mH <math>R_{B2} = 0</math> <math>V_{CC} = 15</math> Volts <math>R_{B1}</math> selected for desired <math>I_{B1}</math></td> </tr> </tbody> </table>	$V_{(BR)CEO(sus)}$	Inductive Switching	RBSOA	L = 10 mH $R_{B2} = 8$ $V_{CC} = 20$ Volts $I_{C(pk)} = 100$ mA	L = 200 mH $R_{B2} = 0$ $V_{CC} = 15$ Volts $R_{B1}$ selected for desired $I_{B1}$	L = 500 mH $R_{B2} = 0$ $V_{CC} = 15$ Volts $R_{B1}$ selected for desired $I_{B1}$	<p><math>V_{CC} = 125</math> V <math>R_C = 25</math> <math>D = 1N5820</math> OR EQUIV.</p>
$V_{(BR)CEO(sus)}$	Inductive Switching	RBSOA						
L = 10 mH $R_{B2} = 8$ $V_{CC} = 20$ Volts $I_{C(pk)} = 100$ mA	L = 200 mH $R_{B2} = 0$ $V_{CC} = 15$ Volts $R_{B1}$ selected for desired $I_{B1}$	L = 500 mH $R_{B2} = 0$ $V_{CC} = 15$ Volts $R_{B1}$ selected for desired $I_{B1}$						
TEST WAVEFORMS	 <p><math>t_1</math> ADJUSTED TO OBTAIN <math>I_C</math></p> $t_1 \approx \frac{L_{coil} (I_{CM})}{V_{CC}}$ $t_2 \approx \frac{L_{coil} (I_{CM})}{V_{clamp}}$ <p>TEST EQUIPMENT SCOPE — TEKTRONIX 475 OR EQUIVALENT</p>	<p><b>TYPICAL WAVEFORMS</b></p>  <p><math>V_{CE}</math> PEAK</p> <p><math>I_{B1}</math></p> <p><math>I_{B2}</math></p> <p>9 V</p> <p>25 <math>\mu</math>s</p> <p><math>t_r, t_f &lt; 10</math> ns</p> <p>DUTY CYCLE = 1.0%</p> <p><math>R_B</math> AND <math>R_C</math> ADJUSTED FOR DESIRED <math>I_B</math> AND <math>I_C</math></p>						

**VOLTAGE REQUIREMENTS** (continued)

In the four application examples (Table 2) load lines are shown in relation to the pulsed forward and reverse biased SOA curves.

In circuits A and D, inductive reactance is clamped by the diodes shown. In circuits B and C the voltage is clamped by the output rectifiers, however, the voltage induced in the primary leakage inductance is not clamped by these diodes and could be large enough to destroy the device. A snubber network or an additional clamp may be required to keep the turn-off load line within the Reverse Bias SOA curve.

Load lines that fall within the pulsed forward biased SOA curve during turn-on and within the reverse bias SOA curve during turn-off are considered safe, with the following assumptions:

1. The device thermal limitations are not exceeded.
2. The turn-on time does not exceed 10  $\mu$ s (see standard pulsed forward SOA curves in Figure 6).
3. The base drive conditions are within the specified limits shown on the Reverse Bias SOA curve (Figure 7).

**CURRENT REQUIREMENTS**

An efficient switching transistor must operate at the required current level with good fall time, high energy handling capability and low saturation voltage. On this data sheet, these parameters have been specified at 5.0 amperes which represents typical design conditions for these devices. The current drive requirements are usually dictated by the  $V_{CE(sat)}$  specification because the maximum saturation voltage is specified at a forced gain condition which must be duplicated or exceeded in the application to control the saturation voltage.

**SWITCHING REQUIREMENTS**

In many switching applications, a major portion of the transistor power dissipation occurs during the fall time ( $t_{fi}$ ). For this reason considerable effort is usually devoted to reducing the fall time. The recommended way to accomplish this is to reverse bias the base-emitter junction during turn-off. The reverse biased switching characteristics for inductive loads are shown in Figures 12 and 13 and resistive loads in Figures 10 and 11. Usually the inductive load components will be the dominant factor in SWITCHMODE applications and the inductive switching data will more closely represent the device performance in actual application. The inductive switching characteristics are derived from the same circuit used to specify the reverse biased SOA curves, (see Table 1) providing correlation between test procedures and actual use conditions.

**SWITCHING TIME NOTES**

In resistive switching circuits, rise, fall, and storage times have been defined and apply to both current and voltage waveforms since they are in phase. However, for inductive loads which are common to SWITCHMODE power supplies and any coil driver, current and voltage waveforms are not in phase. Therefore, separate measurements must be made on each waveform to determine the total switching time. For this reason, the following new terms have been defined.

$t_{sv}$  = Voltage Storage Time, 90%  $I_{B1}$  to 10%  $V_{clamp}$

$t_{rv}$  = Voltage Rise Time, 10–90%  $V_{clamp}$

$t_{fi}$  = Current Fall Time, 90–10%  $I_C$

$t_{ti}$  = Current Tail, 10–2%  $I_C$

$t_c$  = Crossover Time, 10%  $V_{clamp}$  to 10%  $I_C$

An enlarged portion of the turn-off waveforms is shown in Figure 12 to aid in the visual identity of these terms. For the designer, there is minimal switching loss during storage time and the predominant switching power losses occur during the crossover interval and can be obtained using the standard equation from AN222A:

$$P_{SWT} = 1/2 V_{CC} I_C (t_c) f$$

Typical inductive switching times are shown in Figure 13. In general,  $t_{rv} + t_{fi} \approx t_c$ . However, at lower test currents this relationship may not be valid.

As is common with most switching transistors, resistive switching is specified at 25°C and has become a benchmark for designers. However, for designers of high frequency converter circuits, the user oriented specifications which make this a “SWITCHMODE” transistor are the inductive switching speeds ( $t_c$  and  $t_{sv}$ ) which are guaranteed at 100°C.

SWITCHING PERFORMANCE

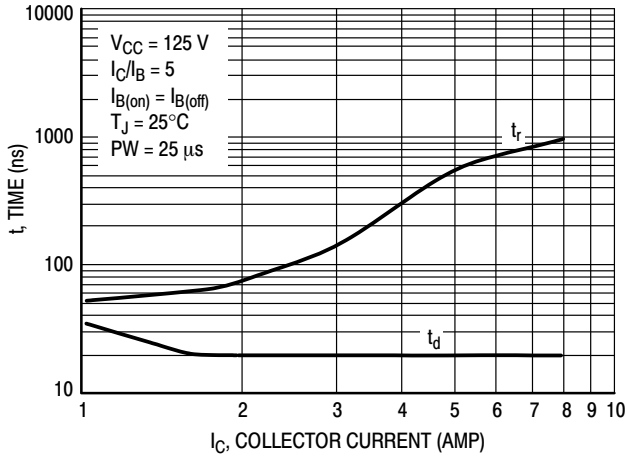

Figure 10. Turn-On Time (Resistive Load)

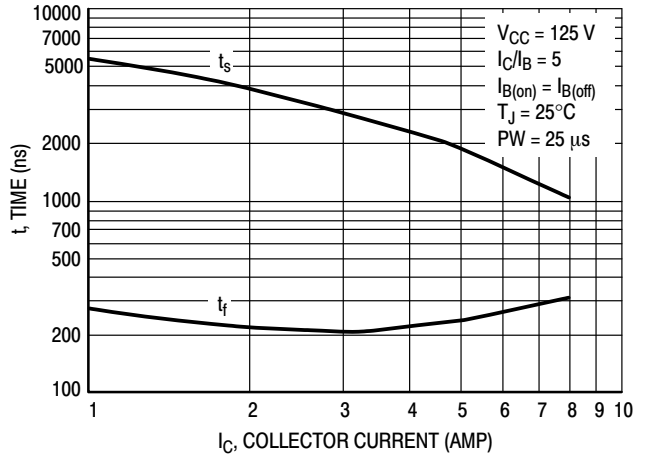

Figure 11. Turn-Off Time (Resistive Load)

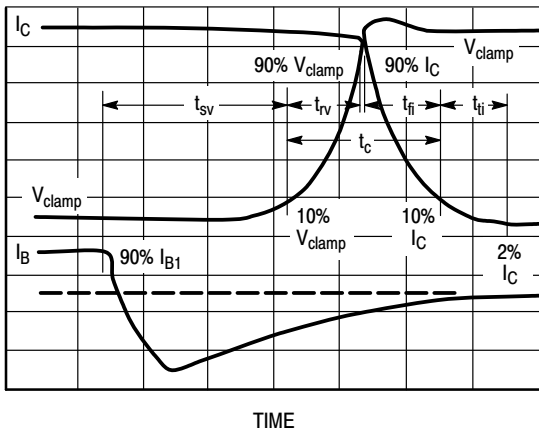

Figure 12. Inductive Switching Measurements

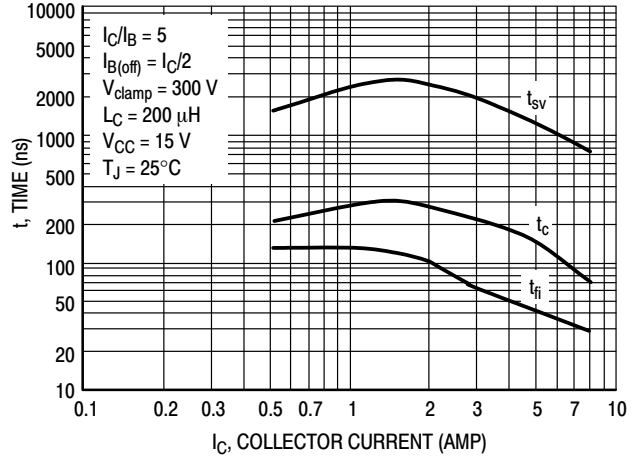
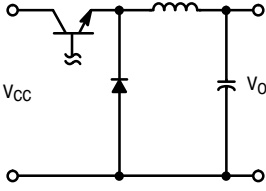
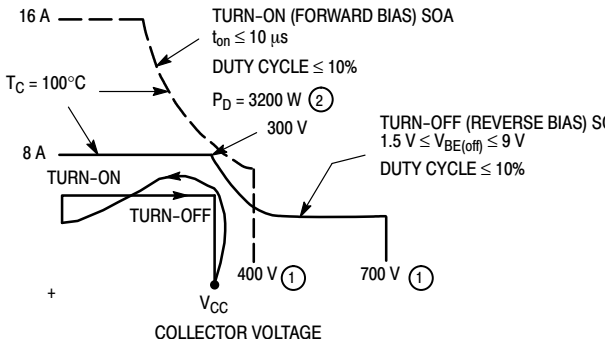
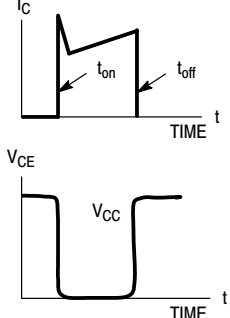
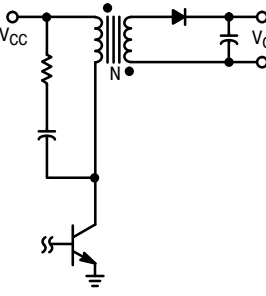
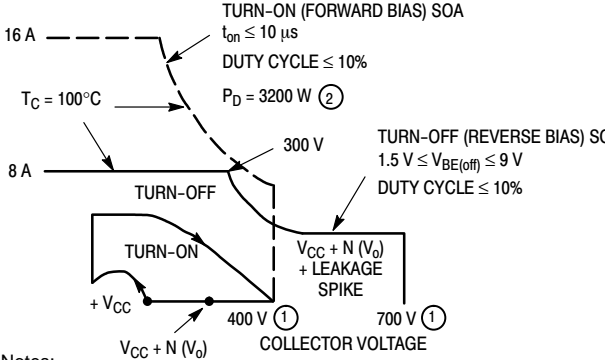
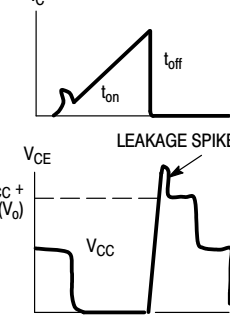
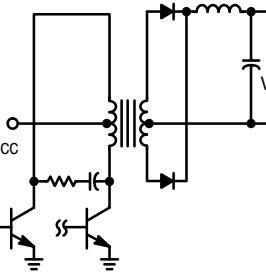
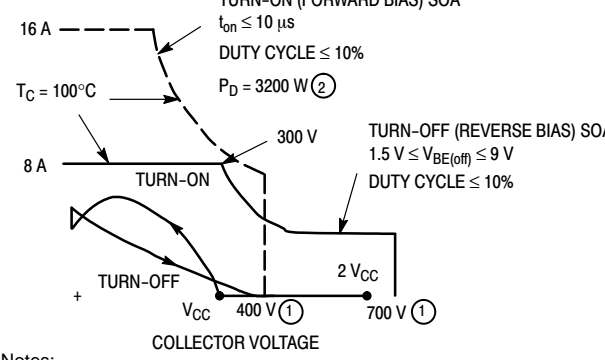
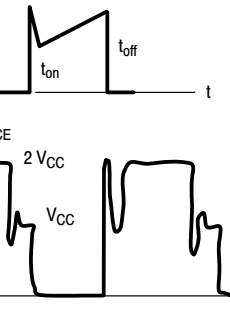
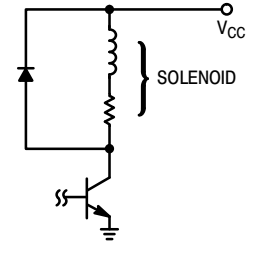
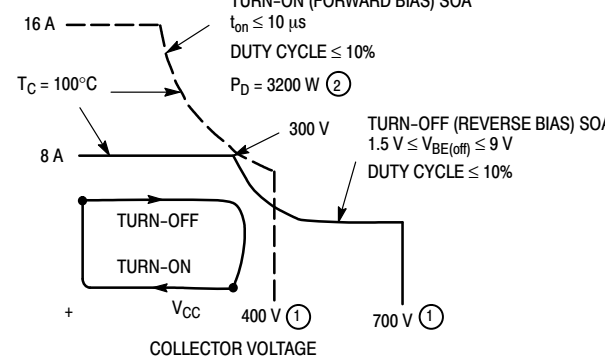
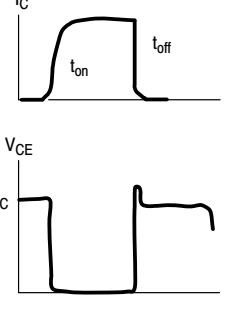

Figure 13. Typical Inductive Switching Times



Table 2. Applications Examples of Switching Circuits

CIRCUIT	LOAD LINE DIAGRAMS	TIME DIAGRAMS
<p><b>A</b></p> <p><b>SERIES SWITCHING REGULATOR</b></p> 	<p><b>LOAD LINE DIAGRAMS</b></p>  <p>Notes:              ① See AN569 for Pulse Power Derating Procedure.</p>	<p><b>TIME DIAGRAMS</b></p> 
<p><b>B</b></p> <p><b>FLYBACK INVERTER</b></p> 	<p><b>LOAD LINE DIAGRAMS</b></p>  <p>Notes:              ① See AN569 for Pulse Power Derating Procedure.</p>	<p><b>TIME DIAGRAMS</b></p> 
<p><b>C</b></p> <p><b>PUSH-PULL INVERTER/CONVERTER</b></p> 	<p><b>LOAD LINE DIAGRAMS</b></p>  <p>Notes:              ① See AN569 for Pulse Power Derating Procedure.</p>	<p><b>TIME DIAGRAMS</b></p> 
<p><b>D</b></p> <p><b>SOLENOID DRIVER</b></p> 	<p><b>LOAD LINE DIAGRAMS</b></p>  <p>Notes:              ① See AN569 for Pulse Power Derating Procedure.</p>	<p><b>TIME DIAGRAMS</b></p> 

# MJE13007

## PACKAGE DIMENSIONS

### TO-220 CASE 221A-09 ISSUE AH

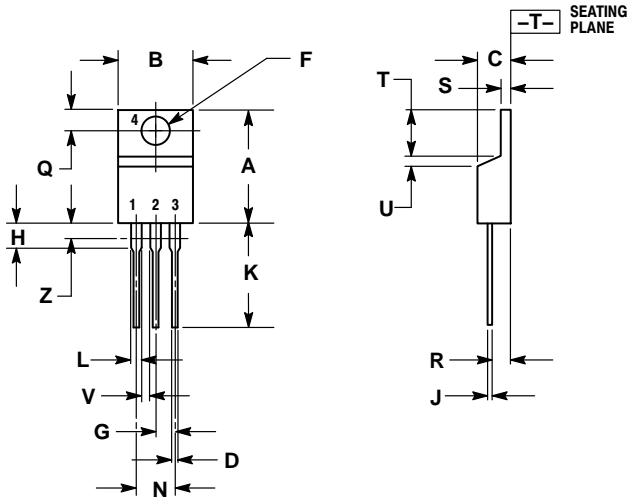

#### NOTES:

1. DIMENSIONING AND TOLERANCING PER ANSI Y14.5M, 1982.
2. CONTROLLING DIMENSION: INCH.
3. DIMENSION Z DEFINES A ZONE WHERE ALL BODY AND LEAD IRREGULARITIES ARE ALLOWED.

DIM	INCHES		MILLIMETERS	
	MIN	MAX	MIN	MAX
A	0.570	0.620	14.48	15.75
B	0.380	0.415	9.66	10.53
C	0.160	0.190	4.07	4.83
D	0.025	0.038	0.64	0.96
F	0.142	0.161	3.61	4.09
G	0.095	0.105	2.42	2.66
H	0.110	0.161	2.80	4.10
J	0.014	0.024	0.36	0.61
K	0.500	0.562	12.70	14.27
L	0.045	0.060	1.15	1.52
N	0.190	0.210	4.83	5.33
Q	0.100	0.120	2.54	3.04
R	0.080	0.110	2.04	2.79
S	0.045	0.055	1.15	1.39
T	0.235	0.255	5.97	6.47
U	0.000	0.050	0.00	1.27
V	0.045	---	1.15	---
Z	---	0.080	---	2.04

#### STYLE 1:

1. BASE
2. COLLECTOR
3. EMITTER
4. COLLECTOR

**ON Semiconductor** and  are registered trademarks of Semiconductor Components Industries, LLC (SCILLC). SCILLC owns the rights to a number of patents, trademarks, copyrights, trade secrets, and other intellectual property. A listing of SCILLC's product/patent coverage may be accessed at [www.onsemi.com/site/pdf/Patent-Marking.pdf](http://www.onsemi.com/site/pdf/Patent-Marking.pdf). SCILLC reserves the right to make changes without further notice to any products herein. SCILLC makes no warranty, representation or guarantee regarding the suitability of its products for any particular purpose, nor does SCILLC assume any liability arising out of the application or use of any product or circuit, and specifically disclaims any and all liability, including without limitation special, consequential or incidental damages. "Typical" parameters which may be provided in SCILLC data sheets and/or specifications can and do vary in different applications and actual performance may vary over time. All operating parameters, including "Typicals" must be validated for each customer application by customer's technical experts. SCILLC does not convey any license under its patent rights nor the rights of others. SCILLC products are not designed, intended, or authorized for use as components in systems intended for surgical implant into the body, or other applications intended to support or sustain life, or for any other application in which the failure of the SCILLC product could create a situation where personal injury or death may occur. Should Buyer purchase or use SCILLC products for any such unintended or unauthorized application, Buyer shall indemnify and hold SCILLC and its officers, employees, subsidiaries, affiliates, and distributors harmless against all claims, costs, damages, and expenses, and reasonable attorney fees arising out of, directly or indirectly, any claim of personal injury or death associated with such unintended or unauthorized use, even if such claim alleges that SCILLC was negligent regarding the design or manufacture of the part. SCILLC is an Equal Opportunity/Affirmative Action Employer. This literature is subject to all applicable copyright laws and is not for resale in any manner.

#### PUBLICATION ORDERING INFORMATION

##### LITERATURE FULFILLMENT:

Literature Distribution Center for ON Semiconductor  
P.O. Box 5163, Denver, Colorado 80217 USA  
Phone: 303-675-2175 or 800-344-3860 Toll Free USA/Canada  
Fax: 303-675-2176 or 800-344-3867 Toll Free USA/Canada  
Email: [orderlit@onsemi.com](mailto:orderlit@onsemi.com)

**N. American Technical Support:** 800-282-9855 Toll Free  
USA/Canada  
**Europe, Middle East and Africa Technical Support:**  
Phone: 421 33 790 2910  
**Japan Customer Focus Center**  
Phone: 81-3-5817-1050

**ON Semiconductor Website:** [www.onsemi.com](http://www.onsemi.com)

**Order Literature:** <http://www.onsemi.com/orderlit>

For additional information, please contact your local Sales Representative

# Mouser Electronics

Authorized Distributor

Click to View Pricing, Inventory, Delivery & Lifecycle Information:

[ON Semiconductor:](#)

[MJE13007G](#)