

MJF6388 (NPN), MJF6668 (PNP)



Complementary Power Darlington

For Isolated Package Applications

Designed for general-purpose amplifiers and switching applications, where the mounting surface of the device is required to be electrically isolated from the heatsink or chassis.

Features

- Isolated Overmold Package
- Electrically Similar to the Popular 2N6388, 2N6668, TIP102, and TIP107
- No Isolating Washers Required, Reduced System Cost
- High DC Current Gain
- High Isolation Voltage
- UL Recognized at 3500 VRMS: File #E69369
- These Devices are Pb-Free and are RoHS Compliant*

MAXIMUM RATINGS

Rating	Symbol	Value	Unit
Collector-Emitter Voltage	V_{CEO}	100	Vdc
Collector-Base Voltage	V_{CB}	100	Vdc
Emitter-Base Voltage	V_{EB}	5.0	Vdc
RMS Isolation Voltage (Note 1) ($t = 0.3$ sec, R.H. $\leq 30\%$, $T_A = 25^\circ\text{C}$) Per Figure 14	V_{ISOL}	4500	V
Collector Current - Continuous	I_C	10	A dc
Collector Current - Peak (Note 2)	I_{CM}	15	A dc
Base Current - Continuous	I_B	1.0	A dc
Total Power Dissipation (Note 3) @ $T_C = 25^\circ\text{C}$ Derate above 25°C	P_D	40 0.31	W W/ $^\circ\text{C}$
Total Power Dissipation @ $T_A = 25^\circ\text{C}$ Derate above 25°C	P_D	2.0 0.016	W W/ $^\circ\text{C}$
Operating and Storage Temperature Range	T_J, T_{stg}	-65 to +150	$^\circ\text{C}$

Stresses exceeding Maximum Ratings may damage the device. Maximum Ratings are stress ratings only. Functional operation above the Recommended Operating Conditions is not implied. Extended exposure to stresses above the Recommended Operating Conditions may affect device reliability.

1. Proper strike and creepage distance must be provided.
2. Pulse Test: Pulse Width = 5.0 ms, Duty Cycle $\leq 10\%$.
3. Measurement made with thermocouple contacting the bottom insulated surface (in a location beneath the die), the devices mounted on a heatsink with thermal grease and a mounting torque of ≥ 6 in. lbs.

THERMAL CHARACTERISTICS

Characteristic	Symbol	Max	Unit
Thermal Resistance, Junction-to-Case (Note 4)	$R_{\theta JC}$	4.0	$^\circ\text{C/W}$
Thermal Resistance, Junction-to-Ambient	$R_{\theta JA}$	62.5	$^\circ\text{C/W}$
Lead Temperature for Soldering Purposes	T_L	260	$^\circ\text{C}$

4. Measurement made with thermocouple contacting the bottom insulated surface (in a location beneath the die), the devices mounted on a heatsink with thermal grease and a mounting torque of ≥ 6 in. lbs.

ON Semiconductor®

<http://onsemi.com>

COMPLEMENTARY SILICON POWER DARLINGTONS 10 AMPERES 100 VOLTS, 40 WATTS

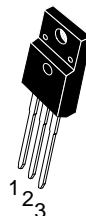
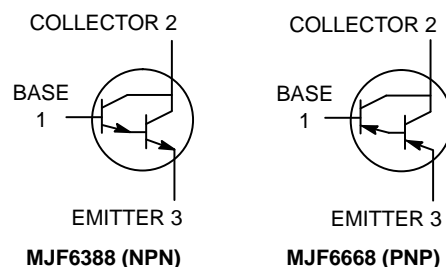

TO-220 FULLPACK
CASE 221D
STYLE 2
UL RECOGNIZED

MARKING DIAGRAM



MJF6xy8 = Specific Device Code
 x = 3 or 6
 y = 6 or 8
 G = Pb-Free Package
 A = Assembly Location
 Y = Year
 WW = Work Week

ORDERING INFORMATION

Device	Package	Shipping
MJF6388G	TO-220 FULLPACK (Pb-Free)	50 Units/Rail
MJF6668G	TO-220 FULLPACK (Pb-Free)	50 Units/Rail

*For additional information on our Pb-Free strategy and soldering details, please download the ON Semiconductor Soldering and Mounting Techniques Reference Manual, SOLDERRM/D.

MJF6388 (NPN), MJF6668 (PNP)

ELECTRICAL CHARACTERISTICS ($T_C = 25^\circ\text{C}$ unless otherwise noted)

Characteristic	Symbol	Min	Max	Unit
OFF CHARACTERISTICS				
Collector–Emitter Sustaining Voltage (Note 5) ($I_C = 30\text{ mAdc}$, $I_B = 0$)	$V_{CEO(sus)}$	100	–	Vdc
Collector Cutoff Current ($V_{CE} = 80\text{ Vdc}$, $I_B = 0$)	I_{CEO}	–	10	μAdc
Collector Cutoff Current ($V_{CE} = 100\text{ Vdc}$, $V_{EB(off)} = 1.5\text{ Vdc}$) ($V_{CE} = 100\text{ Vdc}$, $V_{EB(off)} = 1.5\text{ Vdc}$, $T_C = 125^\circ\text{C}$)	I_{CEX}	–	10 3.0	μAdc mAdc
Collector Cutoff Current ($V_{CB} = 100\text{ Vdc}$, $I_E = 0$)	I_{CBO}	–	10	μAdc
Emitter Cutoff Current ($V_{BE} = 5.0\text{ Vdc}$, $I_C = 0$)	I_{EBO}	–	2.0	mAdc
ON CHARACTERISTICS (Note 5)				
DC Current Gain ($I_C = 3.0\text{ Adc}$, $V_{CE} = 4.0\text{ Vdc}$) ($I_C = 5.0\text{ Adc}$, $V_{CE} = 3.0\text{ Vdc}$) ($I_C = 8.0\text{ Adc}$, $V_{CE} = 4.0\text{ Vdc}$) ($I_C = 10\text{ Adc}$, $V_{CE} = 3.0\text{ Vdc}$)	h_{FE}	3000 1000 200 100	15000 – – –	–
Collector–Emitter Saturation Voltage ($I_C = 3.0\text{ Adc}$, $I_B = 6.0\text{ mAdc}$) ($I_C = 5.0\text{ Adc}$, $I_B = 0.01\text{ Adc}$) ($I_C = 8.0\text{ Adc}$, $I_B = 80\text{ mAdc}$) ($I_C = 10\text{ Adc}$, $I_B = 0.1\text{ Adc}$)	$V_{CE(sat)}$	– – – –	2.0 2.0 2.5 3.0	Vdc
Base–Emitter Saturation Voltage ($I_C = 5.0\text{ Adc}$, $I_B = 0.01\text{ Adc}$) ($I_C = 10\text{ Adc}$, $I_B = 0.1\text{ Adc}$)	$V_{BE(sat)}$	– –	2.8 4.5	Vdc
Base–Emitter On Voltage ($I_C = 8.0\text{ Adc}$, $V_{CE} = 4.0\text{ Vdc}$)	$V_{BE(on)}$	–	2.5	Vdc
DYNAMIC CHARACTERISTICS				
Small–Signal Current Gain ($I_C = 1.0\text{ Adc}$, $V_{CE} = 5.0\text{ Vdc}$, $f_{test} = 1.0\text{ MHz}$)	$ h_{fe} $	20	–	–
Output Capacitance ($V_{CB} = 10\text{ Vdc}$, $I_E = 0$, $f = 1.0\text{ MHz}$) MJF6388 MJF6668	C_{ob}	– –	200 300	pF
Insulation Capacitance (Collector–to–External Heatsink)	C_{c-hs}	–	3.0 Typ	pF
Small–Signal Current Gain ($I_C = 1.0\text{ Adc}$, $V_{CE} = 5.0\text{ Vdc}$, $f = 1.0\text{ kHz}$)	h_{fe}	1000	–	–

5. Pulse Test: Pulse Width $\leq 300\ \mu\text{s}$, Duty Cycle $\leq 2.0\%$.

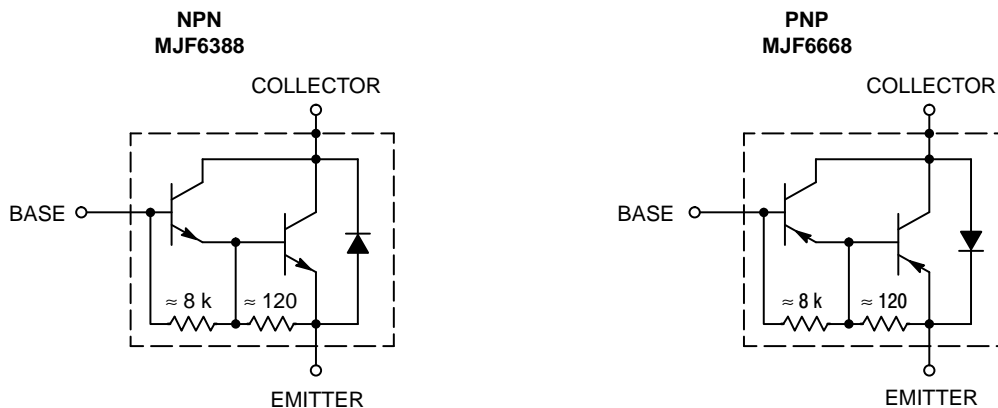

Figure 1. Darlington Schematic

MJF6388 (NPN), MJF6668 (PNP)

R_B & R_C VARIED TO OBTAIN DESIRED CURRENT LEVELS
 D_1 , MUST BE FAST RECOVERY TYPES, e.g.,
 MUR110 USED ABOVE $I_B \approx 100$ mA
 MSD6100 USED BELOW $I_B \approx 100$ mA

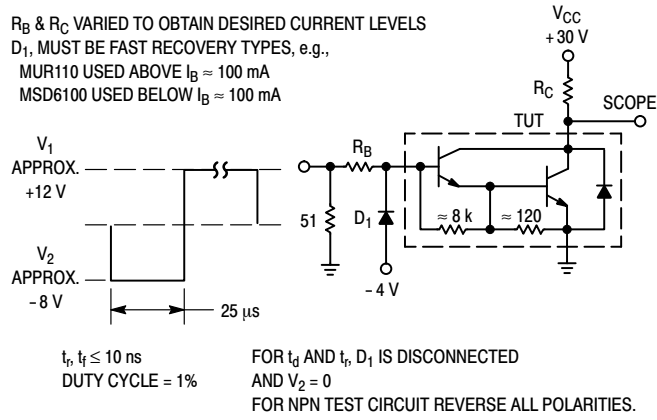

Figure 2. Switching Times Test Circuit

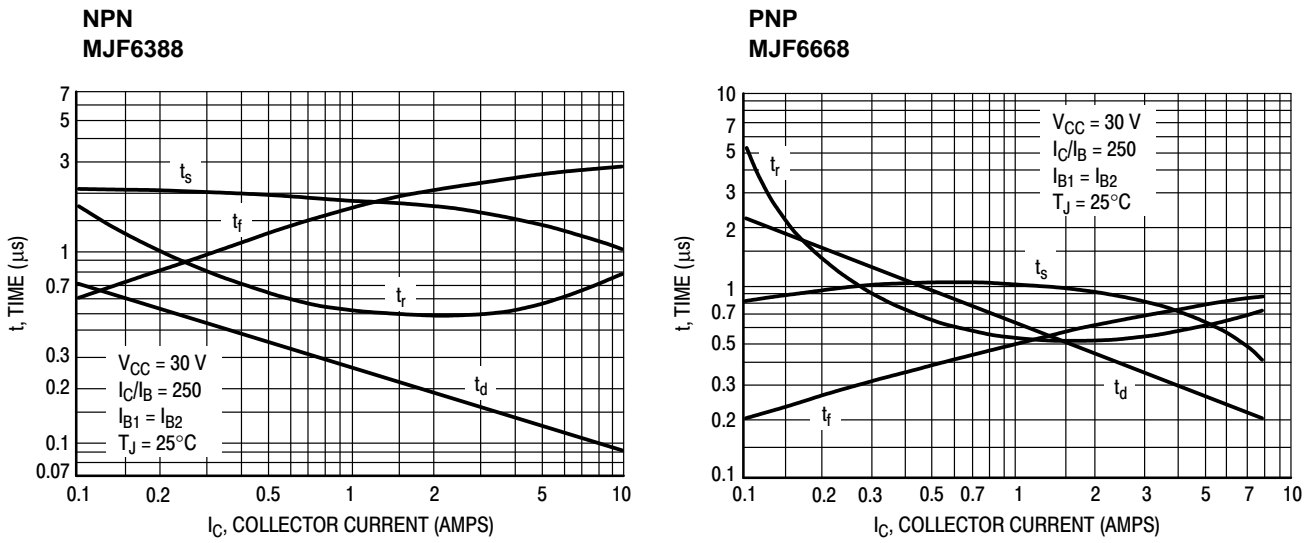

Figure 3. Typical Switching Times

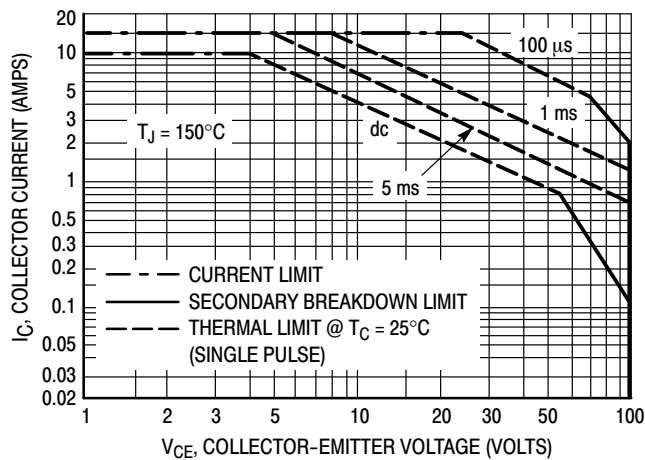

Figure 4. Maximum Forward Bias Safe Operating Area

MJF6388 (NPN), MJF6668 (PNP)

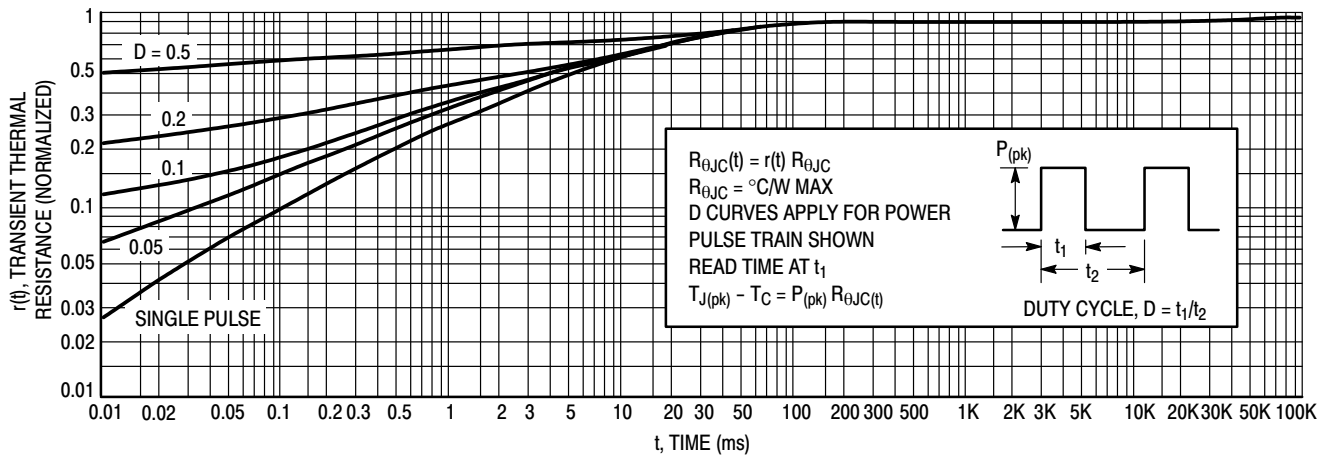

Figure 5. Thermal Response

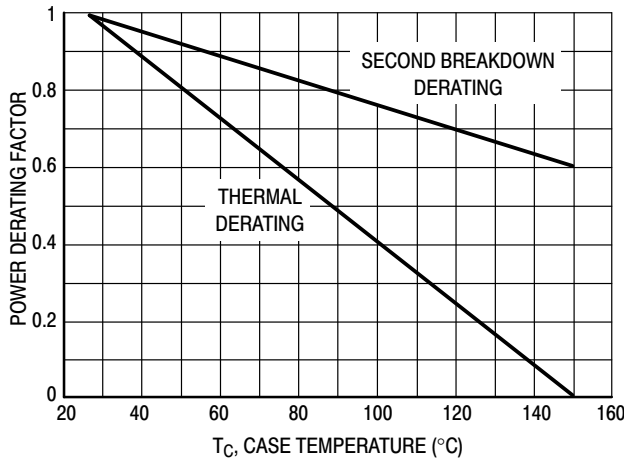

Figure 6. Maximum Power Derating

There are two limitations on the power handling ability of a transistor: average junction temperature and second breakdown. Safe operating area curves indicate $I_C - V_{CE}$ limits of the transistor that must be observed for reliable operation; i.e., the transistor must not be subjected to greater dissipation than the curves indicate.

The data of Figure 4 is based on $T_{J(pk)} = 150\text{°C}$; T_C is variable depending on conditions. Secondary breakdown pulse limits are valid for duty cycles to 10% provided $T_{J(pk)} < 150\text{°C}$. $T_{J(pk)}$ may be calculated from the data in Figure 5. At high case temperatures, thermal limitations will reduce the power that can be handled to values less than the limitations imposed by secondary breakdown.

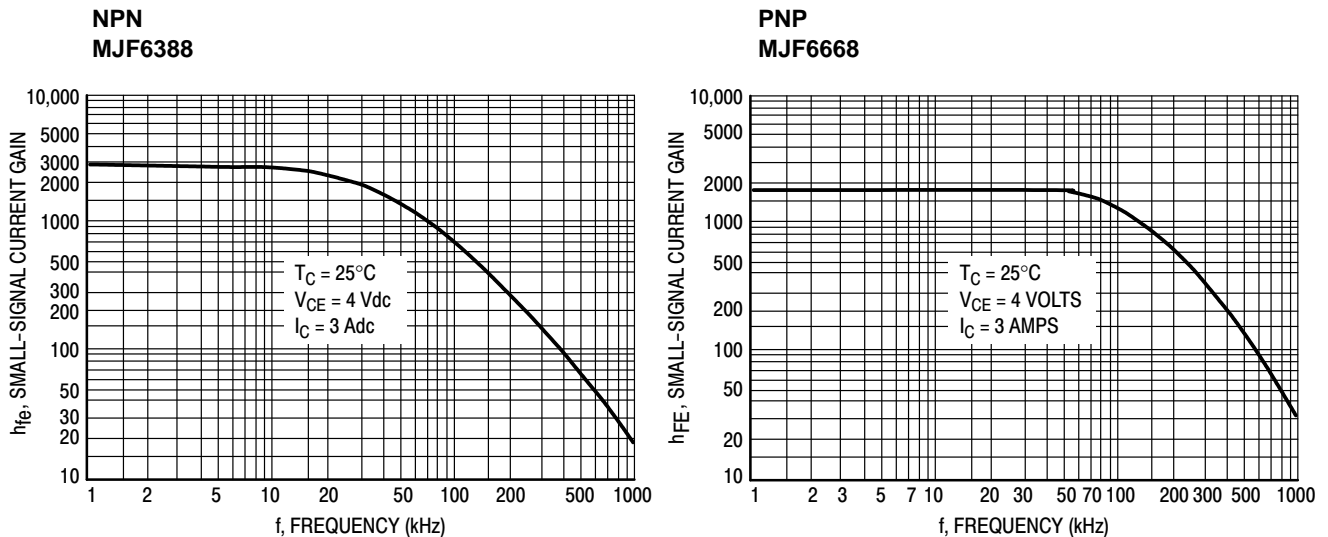

Figure 7. Typical Small-Signal Current Gain

MJF6388 (NPN), MJF6668 (PNP)

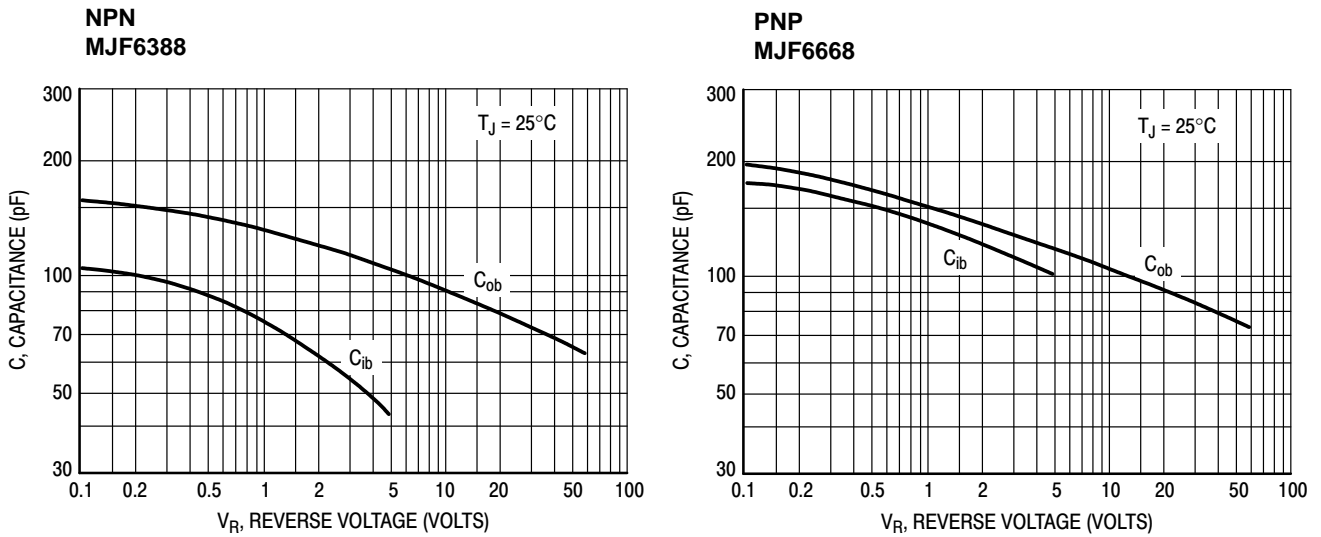

Figure 8. Typical Capacitance

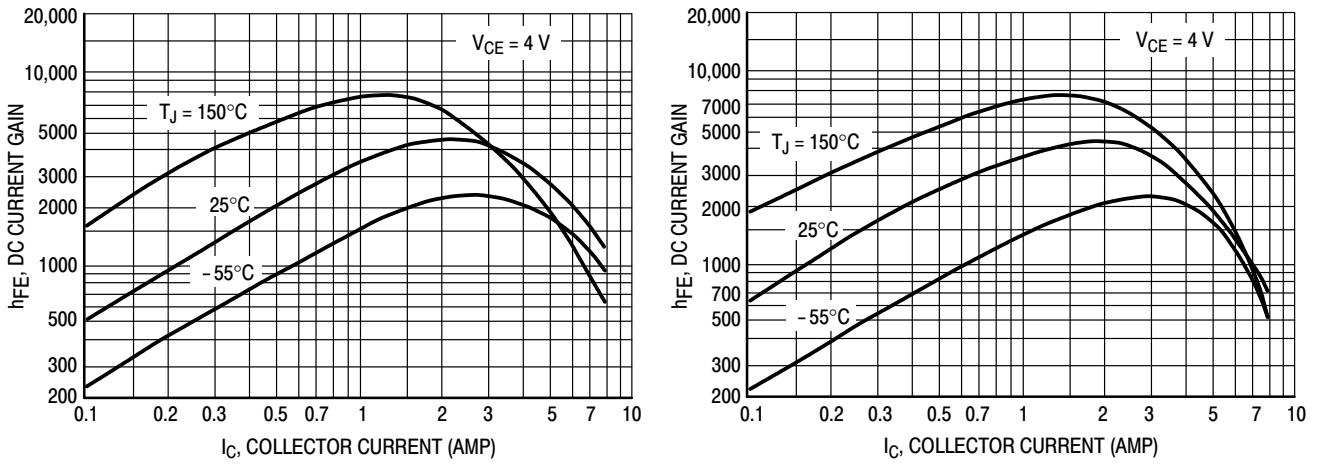

Figure 9. Typical DC Current Gain

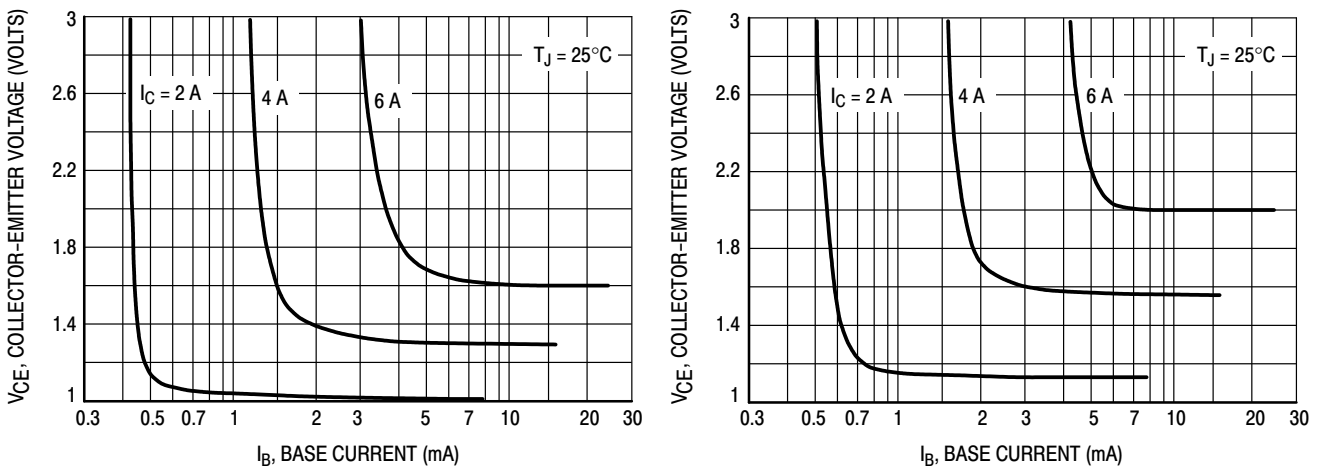

Figure 10. Typical Collector Saturation Region

MJF6388 (NPN), MJF6668 (PNP)

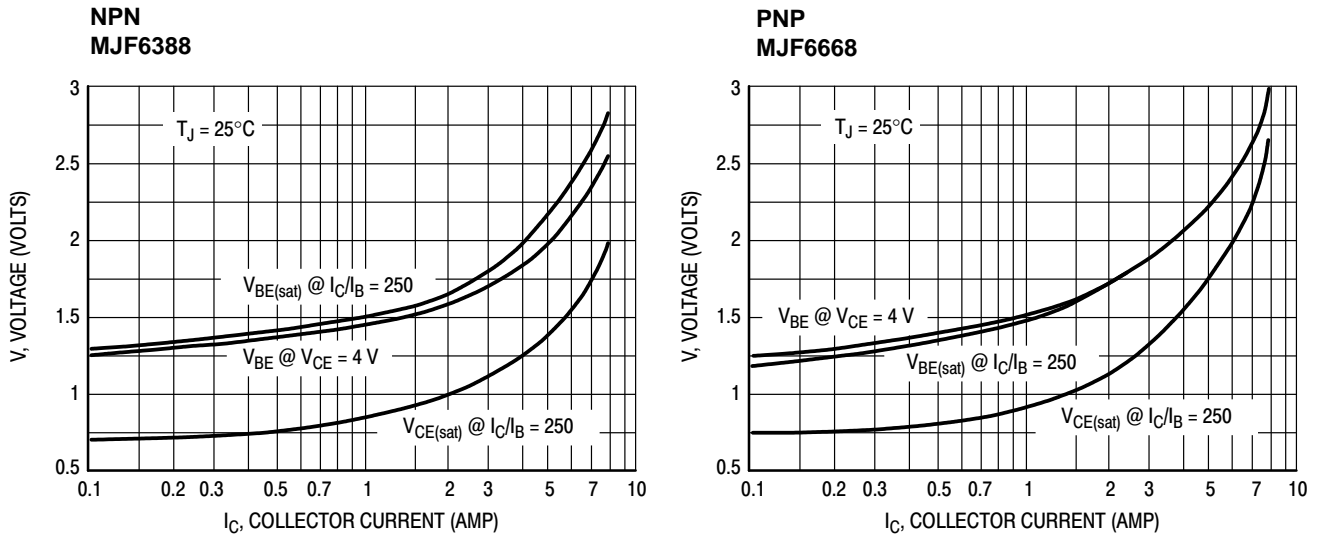

Figure 11. Typical "On" Voltages

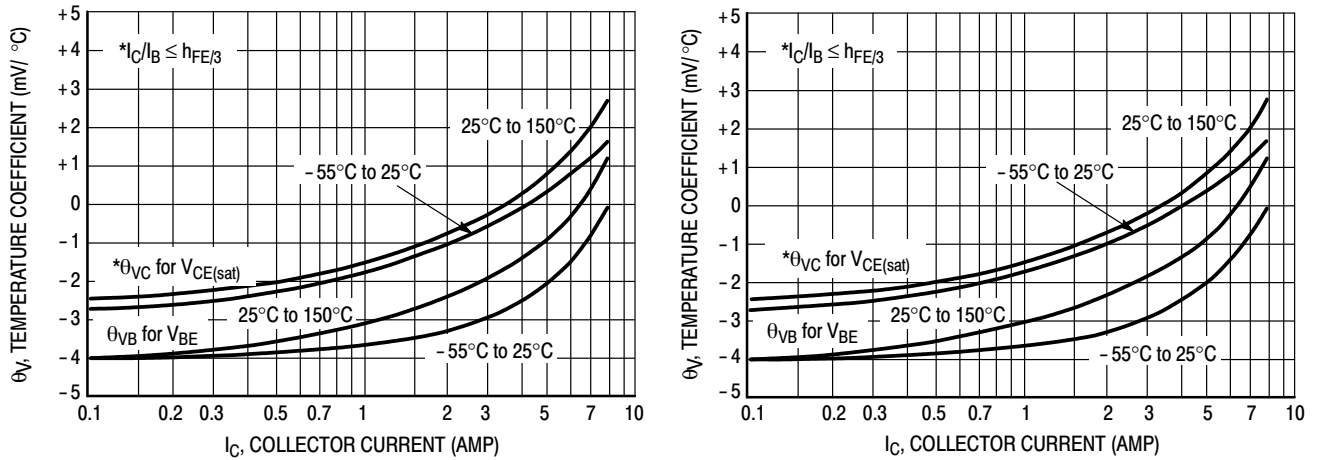

Figure 12. Typical Temperature Coefficients

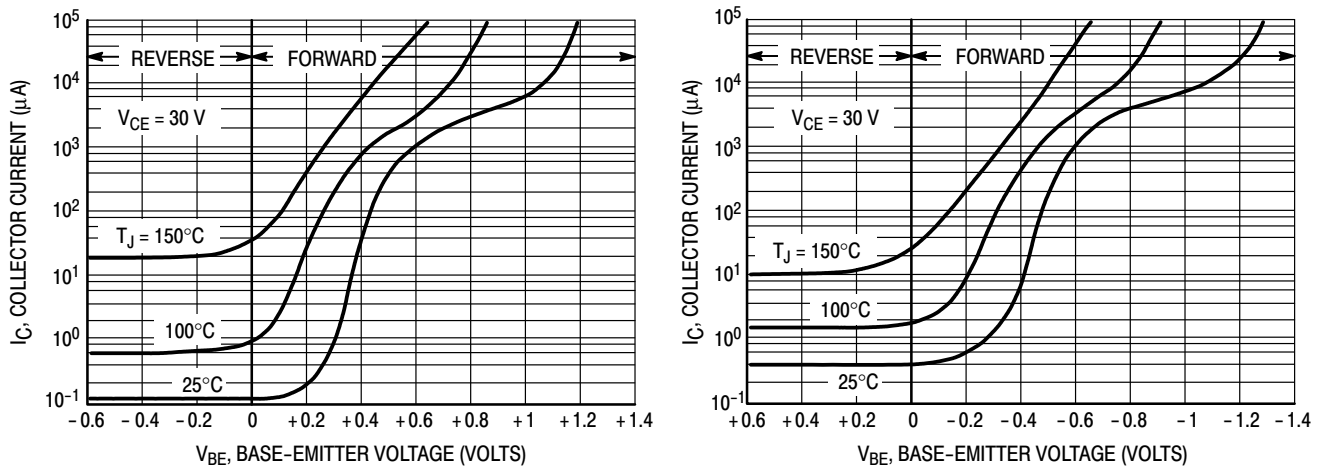

Figure 13. Typical Collector Cut-Off Region

MJF6388 (NPN), MJF6668 (PNP)

TEST CONDITION FOR ISOLATION TEST*

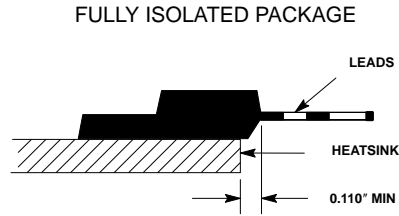

Figure 14. Mounting Position

*Measurement made between leads and heatsink with all leads shorted together.

MOUNTING INFORMATION

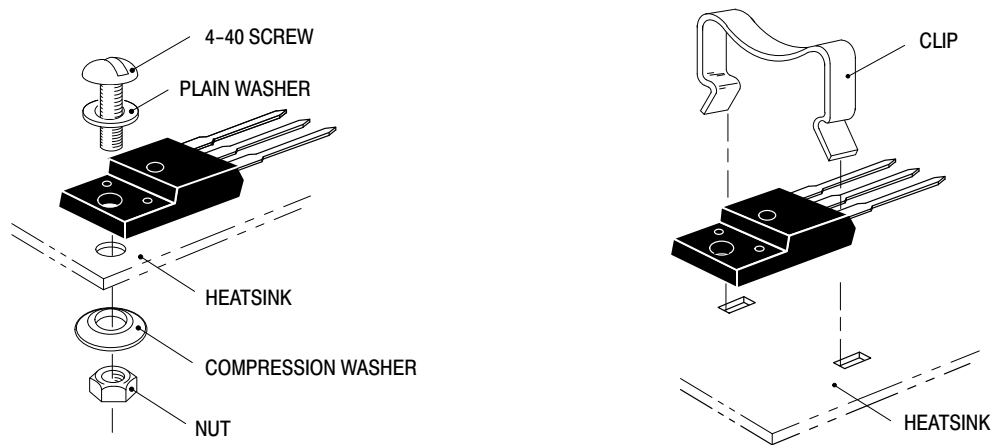

Figure 15. Typical Mounting Techniques*

Laboratory tests on a limited number of samples indicate, when using the screw and compression washer mounting technique, a screw torque of 6 to 8 in · lbs is sufficient to provide maximum power dissipation capability. The compression washer helps to maintain a constant pressure on the package over time and during large temperature excursions.

Destructive laboratory tests show that using a hex head 4–40 screw, without washers, and applying a torque in excess of 20 in · lbs will cause the plastic to crack around the mounting hole, resulting in a loss of isolation capability.

Additional tests on slotted 4–40 screws indicate that the screw slot fails between 15 to 20 in · lbs without adversely affecting the package. However, in order to positively ensure the package integrity of the fully isolated device, ON Semiconductor does not recommend exceeding 10 in · lbs of mounting torque under any mounting conditions.

** For more information about mounting power semiconductors see [Application Note AN1040](#).

MJF6388 (NPN), MJF6668 (PNP)

PACKAGE DIMENSIONS

TO-220 FULLPAK CASE 221D-03 ISSUE K

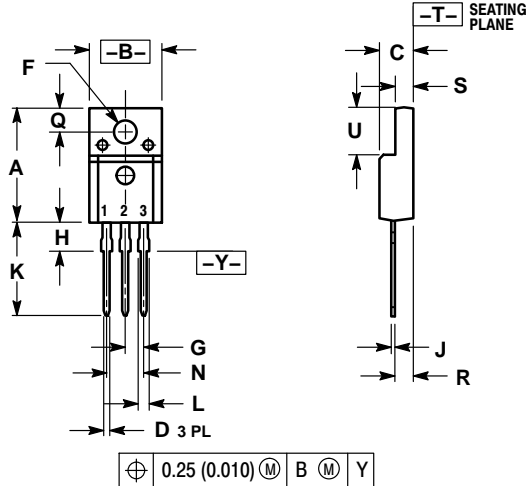

NOTES:

1. DIMENSIONING AND TOLERANCING PER ANSI Y14.5M, 1982.
2. CONTROLLING DIMENSION: INCH
3. 221D-01 THRU 221D-02 OBSOLETE, NEW STANDARD 221D-03.

DIM	INCHES		MILLIMETERS	
	MIN	MAX	MIN	MAX
A	0.617	0.635	15.67	16.12
B	0.392	0.419	9.96	10.63
C	0.177	0.193	4.50	4.90
D	0.024	0.039	0.60	1.00
F	0.116	0.129	2.95	3.28
G	0.100 BSC		2.54 BSC	
H	0.118	0.135	3.00	3.43
J	0.018	0.025	0.45	0.63
K	0.503	0.541	12.78	13.73
L	0.048	0.058	1.23	1.47
N	0.200 BSC		5.08 BSC	
Q	0.122	0.138	3.10	3.50
R	0.099	0.117	2.51	2.96
S	0.092	0.113	2.34	2.87
U	0.239	0.271	6.06	6.88

STYLE 2:

1. BASE
2. COLLECTOR
3. EMITTER

ON Semiconductor and are registered trademarks of Semiconductor Components Industries, LLC (SCILLC). SCILLC owns the rights to a number of patents, trademarks, copyrights, trade secrets, and other intellectual property. A listing of SCILLC's product/patent coverage may be accessed at www.onsemi.com/site/pdf/Patent-Marking.pdf. SCILLC reserves the right to make changes without further notice to any products herein. SCILLC makes no warranty, representation or guarantee regarding the suitability of its products for any particular purpose, nor does SCILLC assume any liability arising out of the application or use of any product or circuit, and specifically disclaims any and all liability, including without limitation special, consequential or incidental damages. "Typical" parameters which may be provided in SCILLC data sheets and/or specifications can and do vary in different applications and actual performance may vary over time. All operating parameters, including "Typicals" must be validated for each customer application by customer's technical experts. SCILLC does not convey any license under its patent rights nor the rights of others. SCILLC products are not designed, intended, or authorized for use as components in systems intended for surgical implant into the body, or other applications intended to support or sustain life, or for any other application in which the failure of the SCILLC product could create a situation where personal injury or death may occur. Should Buyer purchase or use SCILLC products for any such unintended or unauthorized application, Buyer shall indemnify and hold SCILLC and its officers, employees, subsidiaries, affiliates, and distributors harmless against all claims, costs, damages, and expenses, and reasonable attorney fees arising out of, directly or indirectly, any claim of personal injury or death associated with such unintended or unauthorized use, even if such claim alleges that SCILLC was negligent regarding the design or manufacture of the part. SCILLC is an Equal Opportunity/Affirmative Action Employer. This literature is subject to all applicable copyright laws and is not for resale in any manner.

PUBLICATION ORDERING INFORMATION

LITERATURE FULFILLMENT:

Literature Distribution Center for ON Semiconductor
P.O. Box 5163, Denver, Colorado 80217 USA
Phone: 303-675-2175 or 800-344-3860 Toll Free USA/Canada
Fax: 303-675-2176 or 800-344-3867 Toll Free USA/Canada
Email: orderlit@onsemi.com

N. American Technical Support: 800-282-9855 Toll Free
USA/Canada
Europe, Middle East and Africa Technical Support:
Phone: 421 33 790 2910
Japan Customer Focus Center
Phone: 81-3-5817-1050

ON Semiconductor Website: www.onsemi.com

Order Literature: <http://www.onsemi.com/orderlit>

For additional information, please contact your local Sales Representative

Mouser Electronics

Authorized Distributor

Click to View Pricing, Inventory, Delivery & Lifecycle Information:

[ON Semiconductor:](#)

[MJF6388G](#)