

NCP4624

150 mA, Wide Input Range, LDO Linear Voltage Regulator

The NCP4624 is a CMOS 150 mA LDO linear voltage regulator which features high input voltage range while maintaining low quiescent current 2 μ A typically. Several protection features like Current Limiting and Reverse Current Protection Circuit are fully integrated to create a versatile device suitable for the power source being in the standby-mode. A high maximum input voltage (11 V) and wide temperature range (-40°C to 85°C) makes the NCP4624 device with output capacitor as low as 0.1 μ F an ideal choice for industrial applications also a portable equipments powered by 2-cell Li-ion battery.

Features

- Operating Input Voltage Range: 2.5 V to Set $V_{\text{OUT}} + 6.5$ V, Max. 11 V
- Output Voltage Range: 1.2 to 5.5 V (available in 0.1 V steps)
- $\pm 2\%$ Output Voltage Accuracy
- Output Current: min. 150 mA
- Line Regulation: 0.02%/V
- Current Limit Circuit
- Available in SOT-23-5, UDFN 1.0 x 1.0 mm and SC-88A Package
- Built-in Reverse Current Protection Circuit
- These are Pb-Free Devices

Typical Applications

- Home Appliances, Industrial Equipment
- Cable Boxes, Satellite Receivers, Entertainment Systems
- Car Audio Equipment, Navigation Systems
- Notebook Adaptors, LCD TVs, Cordless Phones and Private LAN Systems
- Battery-Powered Portable Communication Equipments

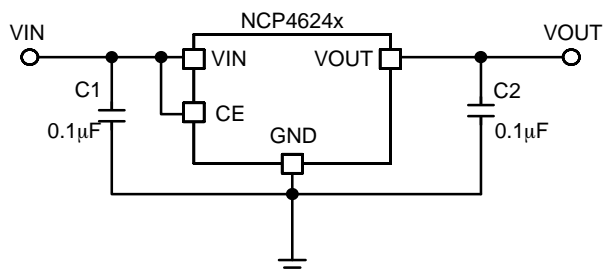

Figure 1. Typical Application Schematic



ON Semiconductor™

<http://onsemi.com>

MARKING DIAGRAMS



SOT-23-5
CASE 1212

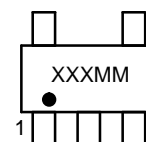

UDFN4
CASE 517BR

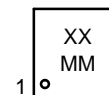

SC-88A
(SC-70-5/SOT-353)
CASE 419A

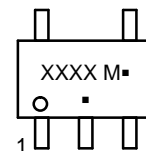

XX, XXX, XXXX = Specific Device Code
M, MM = Date Code
A = Assembly Location
Y = Year
W = Work Week
▪ = Pb-Free Package

(*Note: Microdot may be in either location)

ORDERING INFORMATION

See detailed ordering and shipping information in the package dimensions section on page 15 of this data sheet.

NCP4624

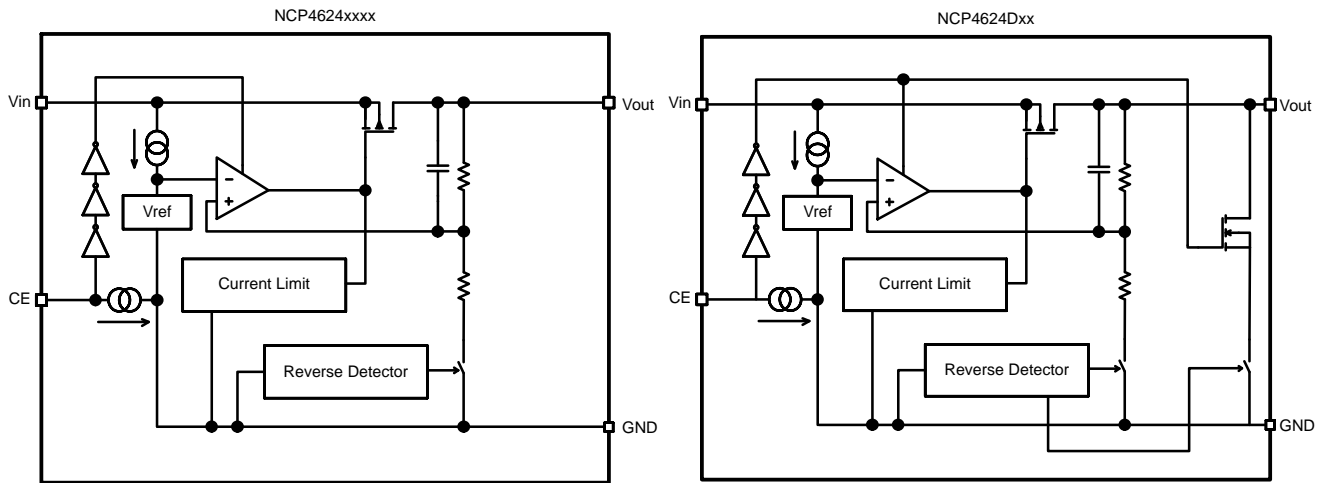

Figure 2. Simplified Schematic Block Diagram

PIN FUNCTION DESCRIPTION

Pin No.			Pin Name	Description
SOT-23-5	SC-88A	UDFN 1x1		
1	5	4	VIN	Input pin
2	3	2	GND	Ground pin
3	1	3	CE	Chip enable pin ("H" active)
4	2		NC	Non connected
5	4	1	VOUT	Output pin
		*EP	EP	Exposed Pad (leave floating or connect to GND)

ABSOLUTE MAXIMUM RATINGS

Rating	Symbol	Value	Unit
Input Voltage (Note 1)	V_{IN}	-0.3 to 12	V
Output Voltage	V_{OUT}	-0.3 to $V_{IN} \leq 11$	V
Chip Enable Input	V_{CE}	-0.3 to $V_{IN} \leq 11$	V
Power Dissipation SOT-23-5	P_D	420	mW
Power Dissipation uDFN 1.0 x 1.0 mm		400	
Power Dissipation SC-88A		380	
Junction Temperature	T_J	-40 to 150	°C
Storage Temperature	T_{STG}	-55 to 125	°C
ESD Capability, Human Body Model (Note 2)	ESD_{HBM}	2000	V
ESD Capability, Machine Model (Note 2)	ESD_{MM}	200	V

Stresses exceeding those listed in the Maximum Ratings table may damage the device. If any of these limits are exceeded, device functionality should not be assumed, damage may occur and reliability may be affected.

1. Refer to Electrical Characteristics and Application Information for safe operating area.
2. This device series incorporates ESD protection and is tested by the following methods:
 ESD Human Body Model tested per AEC-Q100-002 (EIA/JESD22-A114)
 ESD Machine Model tested per AEC-Q100-003 (EIA/JESD22-A115)
 Latchup Current Maximum Rating tested per JEDEC standard: JESD78.

NCP4624

THERMAL CHARACTERISTICS

Rating	Symbol	Value	Unit
Thermal Characteristics, SOT-23-5 Thermal Resistance, Junction-to-Air	$R_{\theta JA}$	238	$^{\circ}\text{C}/\text{W}$
Thermal Characteristics, uDFN 1x1 Thermal Resistance, Junction-to-Air	$R_{\theta JA}$	250	$^{\circ}\text{C}/\text{W}$
Thermal Characteristics, SC-88A Thermal Resistance, Junction-to-Air	$R_{\theta JA}$	263	$^{\circ}\text{C}/\text{W}$

ELECTRICAL CHARACTERISTICS $-40^{\circ}\text{C} \leq T_A \leq 85^{\circ}\text{C}$; $C_{IN} = C_{OUT} = 0.1 \mu\text{F}$, unless otherwise noted. Typical values are at $T_A = +25^{\circ}\text{C}$.

Parameter	Test Conditions	Symbol	Min	Typ	Max	Unit	
Operating Input Voltage	$1.2 \text{ V} < V_{OUT} < 4.5 \text{ V}$	V_{IN}	2.5		$V_{set} + 6.5$	V	
	$4.5 \text{ V} \leq V_{OUT} < 5.5 \text{ V}$				11		
Output Voltage	$T_A = 25^{\circ}\text{C}, V_{OUT} > 1.5 \text{ V}$	V_{OUT}	x0.99		x1.01	V	
	$-40^{\circ}\text{C} < T_A < 85^{\circ}\text{C}, V_{OUT} > 1.5 \text{ V}$		x0.982		x1.018		
	$T_A = 25^{\circ}\text{C}, V_{OUT} < 1.5 \text{ V}$		-15		+15	mV	
	$-40^{\circ}\text{C} < T_A < 85^{\circ}\text{C}, V_{OUT} < 1.5 \text{ V}$		-28		+28		
Output Voltage Temp. Coefficient	$V_{IN} = V_{OUT} + 2 \text{ V}, I_{OUT} = 100 \mu\text{A}, T_A = -40 \text{ to } 105^{\circ}\text{C}$			± 100		ppm/ $^{\circ}\text{C}$	
Line Regulation	Set $V_{OUT} + 0.5 \text{ V} < V_{IN} < V_{IN \text{ max}}, I_{OUT} = 1 \text{ mA}$	Line_{Reg}		0.02	0.20	%/V	
Load Regulation	$V_{IN} = V_{OUT} + 2 \text{ V}, 0.1 \text{ mA} < I_{OUT} \leq 150 \text{ mA}$	Load_{Reg}	-35	-3	35	mV	
Dropout Voltage	$I_{OUT} = 150 \text{ mA}$	V_{DO}	$1.2 \text{ V} \leq V_{OUT} < 1.3 \text{ V}$		1.68	2.59	V
			$1.3 \text{ V} \leq V_{OUT} < 1.5 \text{ V}$		1.63	2.49	
			$1.5 \text{ V} \leq V_{OUT} < 1.8 \text{ V}$		1.48	2.23	
			$1.8 \text{ V} \leq V_{OUT} < 2.3 \text{ V}$		1.16	2.19	
			$2.3 \text{ V} \leq V_{OUT} < 3.0 \text{ V}$		0.90	1.47	
			$3.0 \text{ V} \leq V_{OUT} < 4.0 \text{ V}$		0.61	1.05	
			$4.0 \text{ V} \leq V_{OUT} \leq 5.5 \text{ V}$		0.39	0.76	
Output Current		I_{OUT}	150			mA	
Short Current Limit	$V_{OUT} = 0 \text{ V}$	I_{SC}		45		mA	
Quiescent Current	$I_{out} = 0 \text{ mA}$	I_Q		2.0	3.7	μA	
Standby Current	$V_{IN} = V_{IN \text{ max}}, V_{CE} = 0 \text{ V}$	I_{STB}		0.2	0.6	μA	
CE Pin Pull-Down Current		I_{PD}		0.3	0.9	μA	
CE Pin Threshold Voltage	CE Input Voltage "H"	V_{CEH}	1.7		V_{IN}	V	
	CE Input Voltage "L"	V_{CEL}	0		0.8		
Reverse Current	$0 \text{ V} \leq V_{IN} < 11 \text{ V}, V_{OUT} > 1.5 \text{ V}$	I_{REV}		0	0.16	μA	
Reverse Current Detection Offset	$0 \text{ V} \leq V_{IN} < 11 \text{ V}, V_{OUT} > 1.5 \text{ V}$	V_{REV_DET}		55	100	mV	
Reverse Current Release Offset	$0 \text{ V} \leq V_{IN} < 11 \text{ V}, V_{OUT} > 1.5 \text{ V}$	V_{REV_REL}		70	120	mV	
Power Supply Rejection Ratio	$V_{IN} = V_{OUT} + 2.5 \text{ V},$ $\Delta V_{IN_PK-PK} = 0.3 \text{ V},$ $I_{OUT} = 50 \text{ mA}, f = 1 \text{ kHz}$	PSRR	$V_{OUT} = 1.2 \text{ V}$		27	dB	
			$V_{OUT} = 2.5 \text{ V}$		22		
			$V_{OUT} = 3.3 \text{ V}$		18		
			$V_{OUT} = 5.5 \text{ V}$		15		
Output Noise Voltage	$V_{OUT} = 1.2 \text{ V}, I_{OUT} = 30 \text{ mA}, f = 100 \text{ Hz to } 100 \text{ kHz}$	V_{NOISE}		105		μV_{rms}	
Autodischarge NMOS Resistance	$V_{IN} = 7.0 \text{ V}, V_{CE} = 0.0 \text{ V}$ (D version only)	R_{DSON}		380		Ω	

Product parametric performance is indicated in the Electrical Characteristics for the listed test conditions, unless otherwise noted. Product performance may not be indicated by the Electrical Characteristics if operated under different conditions.

TYPICAL CHARACTERISTICS

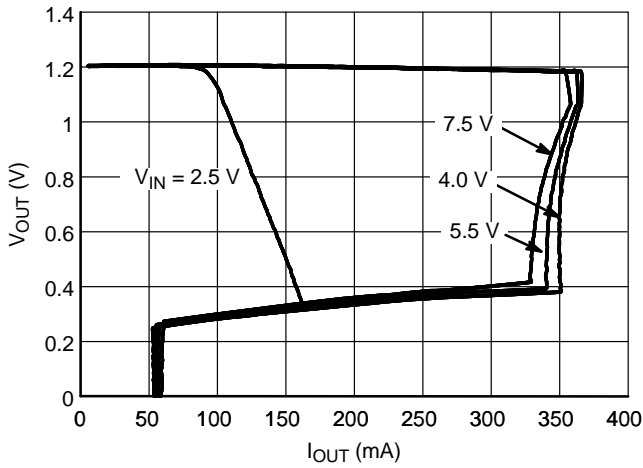

Figure 3. Output Voltage vs. Output Current
1.2 V Version ($T_J = 25^\circ\text{C}$)

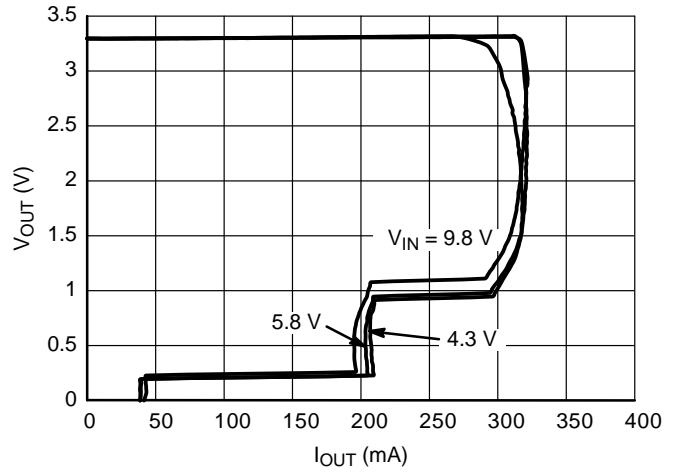

Figure 4. Output Voltage vs. Output Current
3.3 V Version ($T_J = 25^\circ\text{C}$)

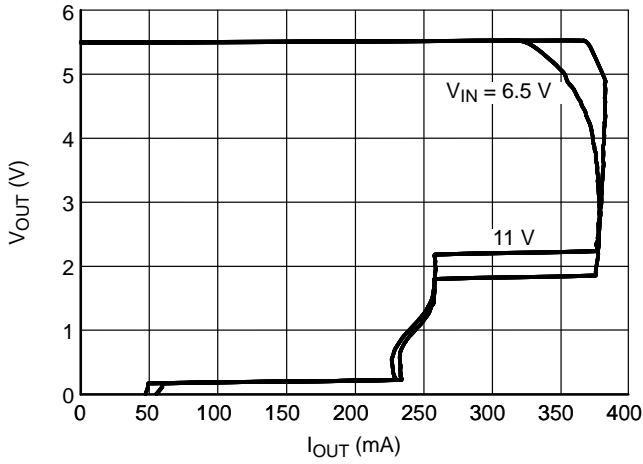

Figure 5. Output Voltage vs. Output Current
5.5 V Version ($T_J = 25^\circ\text{C}$)

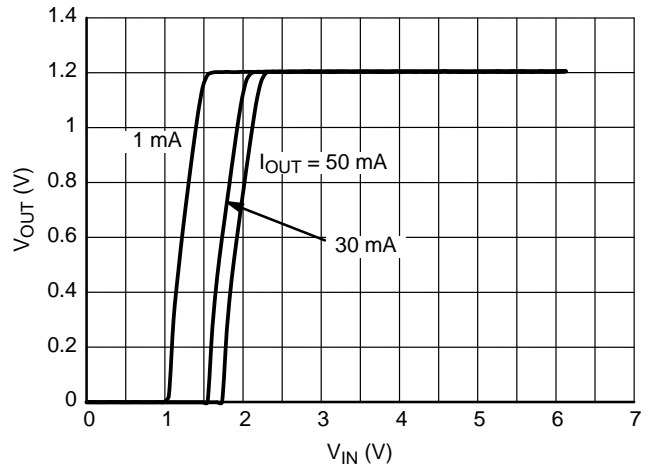

Figure 6. Output Voltage vs. Input Voltage
1.2 V Version

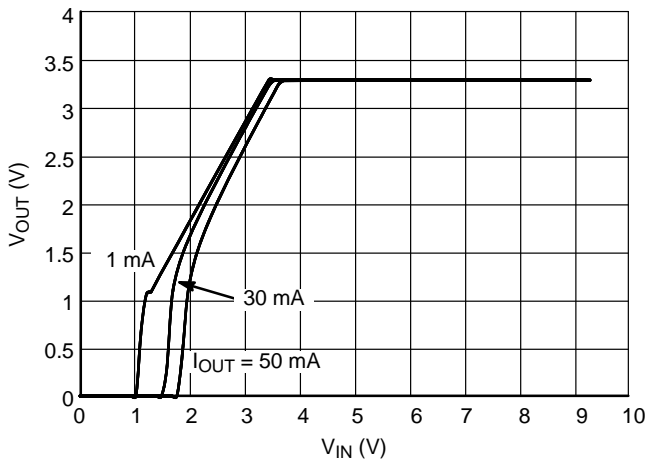

Figure 7. Output Voltage vs. Input Voltage
3.3 V Version

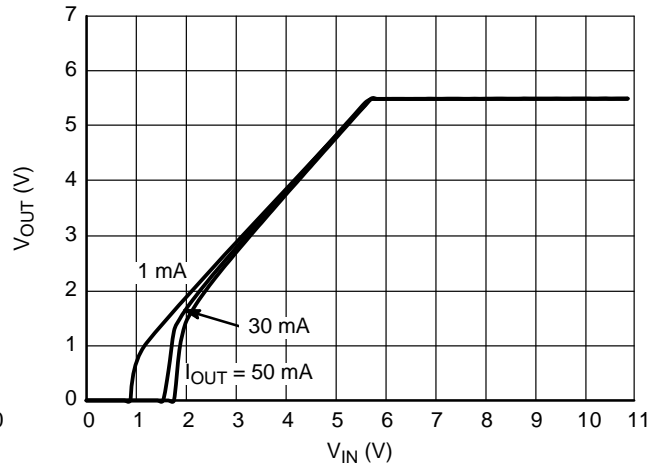

Figure 8. Output Voltage vs. Input Voltage
5.5 V Version

TYPICAL CHARACTERISTICS

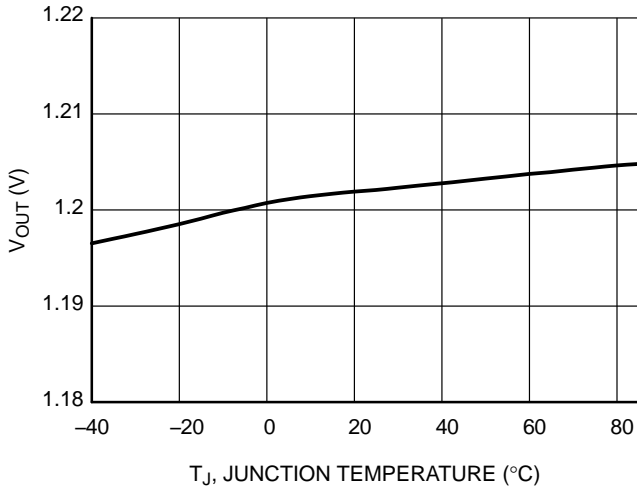

Figure 9. Output Voltage vs. Temperature, 1.2 V Version

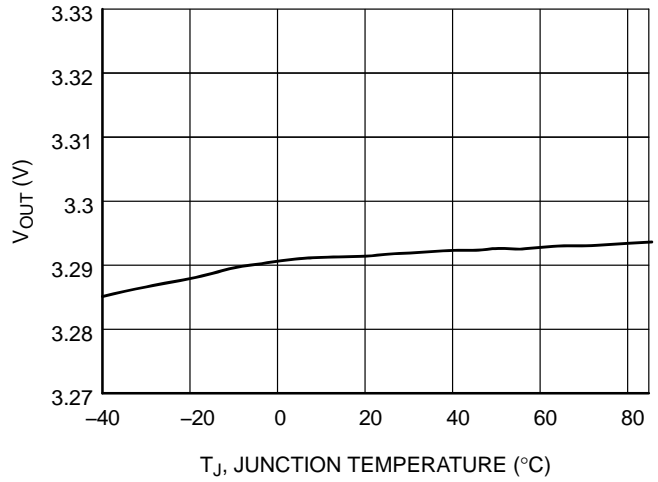

Figure 10. Output Voltage vs. Temperature, 3.3 V Version

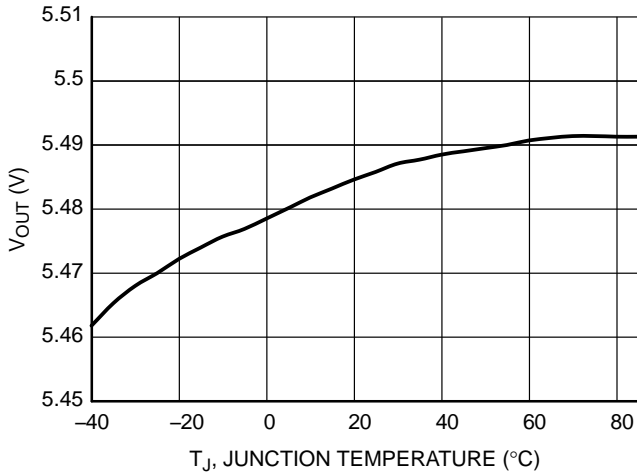

Figure 11. Output Voltage vs. Temperature, 5.5 V Version

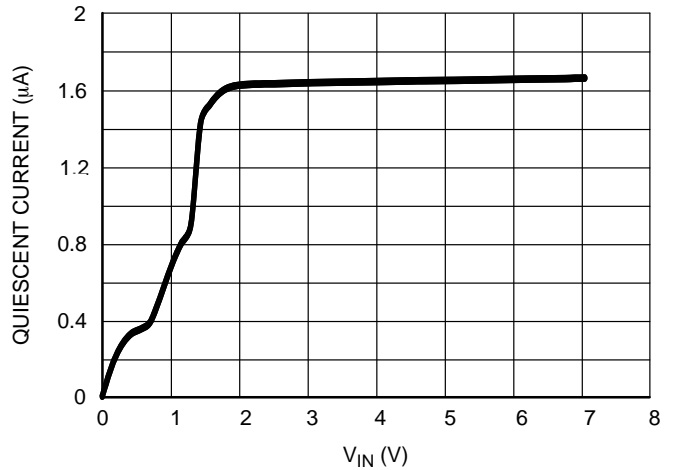

Figure 12. Quiescent Current vs. Input Voltage, 1.2 V Version

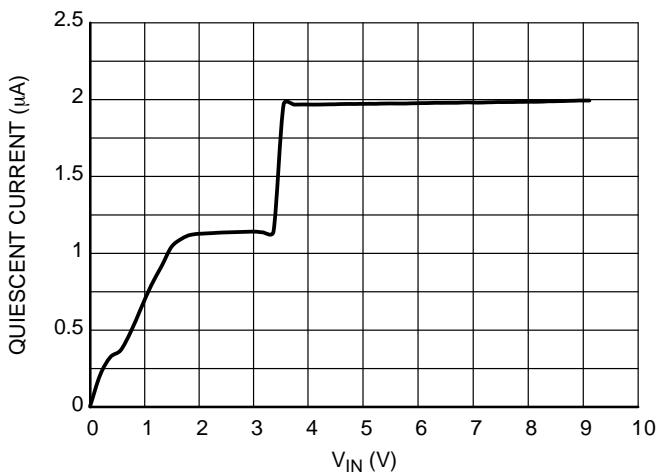

Figure 13. Quiescent Current vs. Input Voltage, 3.3 V Version

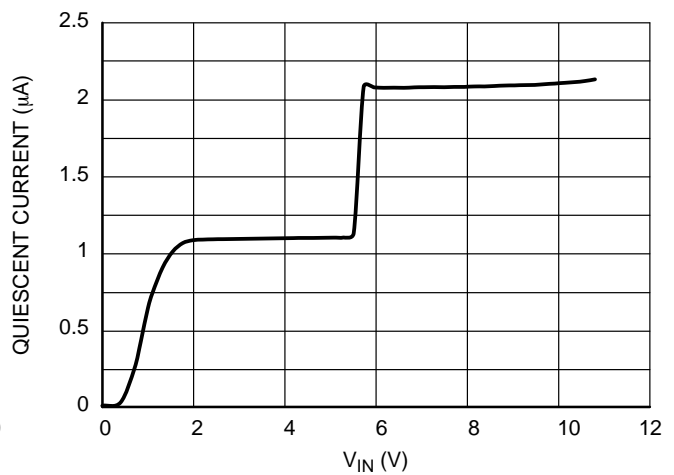

Figure 14. Quiescent Current vs. Input Voltage, 5.5 V Version

TYPICAL CHARACTERISTICS

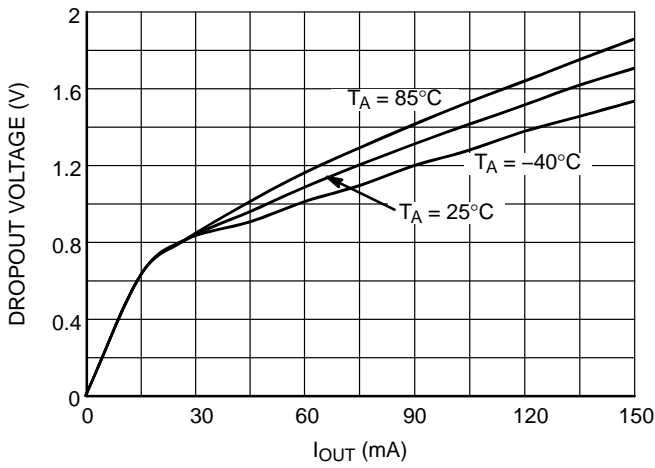

Figure 15. Dropout Voltage vs. Output Current, 1.2 V Version

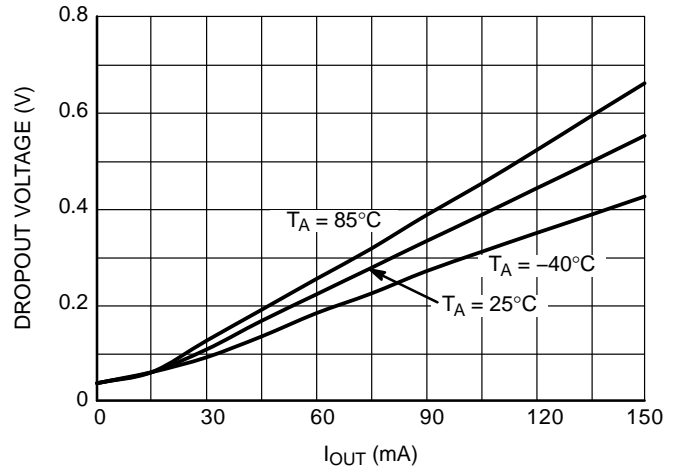

Figure 16. Dropout Voltage vs. Output Current, 3.3 V Version

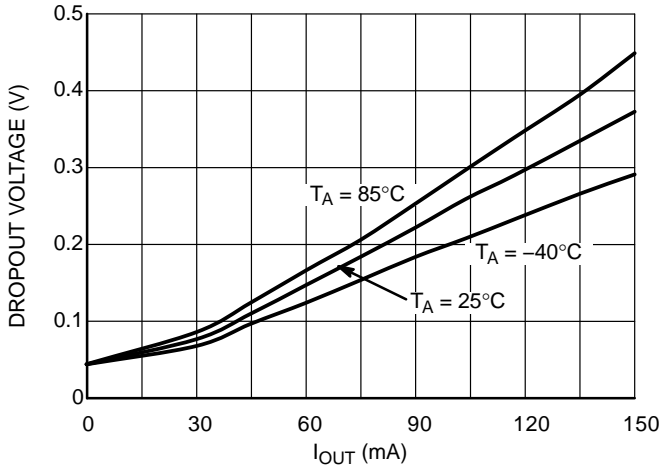

Figure 17. Dropout Voltage vs. Output Current, 5.5 V Version

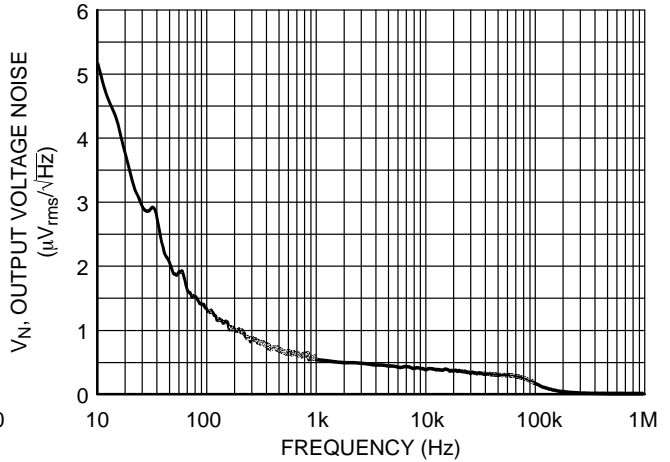

Figure 18. Output Voltage Noise, 1.2 V Version, $V_{IN} = 2.5\text{ V}$, $I_{OUT} = 30\text{ mA}$, $C_{in} = C_{out} = 0.1\text{ }\mu\text{F}$

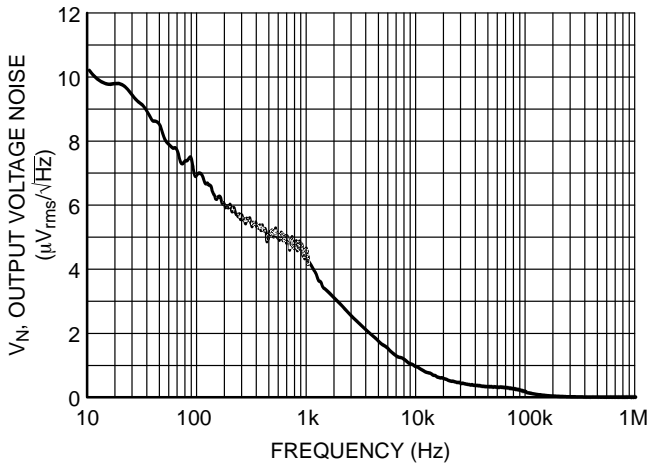

Figure 19. Output Voltage Noise, 3.3 V Version, $V_{IN} = 4.3\text{ V}$, $I_{OUT} = 30\text{ mA}$, $C_{in} = C_{out} = 0.1\text{ }\mu\text{F}$

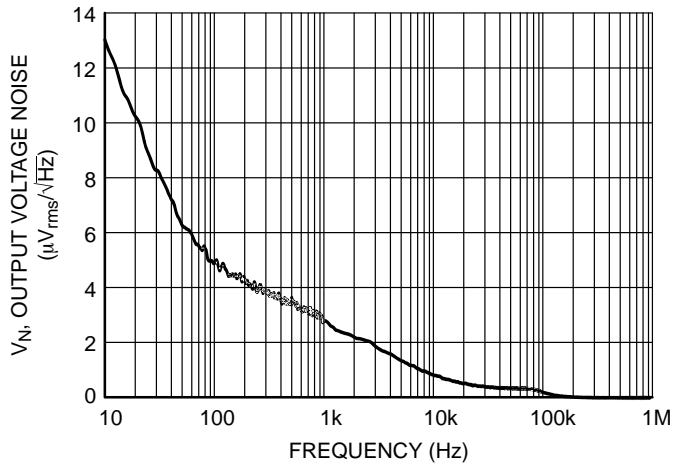

Figure 20. Output Voltage Noise, 5.5 V Version, $V_{IN} = 6.5\text{ V}$, $I_{OUT} = 30\text{ mA}$, $C_{in} = C_{out} = 0.1\text{ }\mu\text{F}$

NCP4624

TYPICAL CHARACTERISTICS

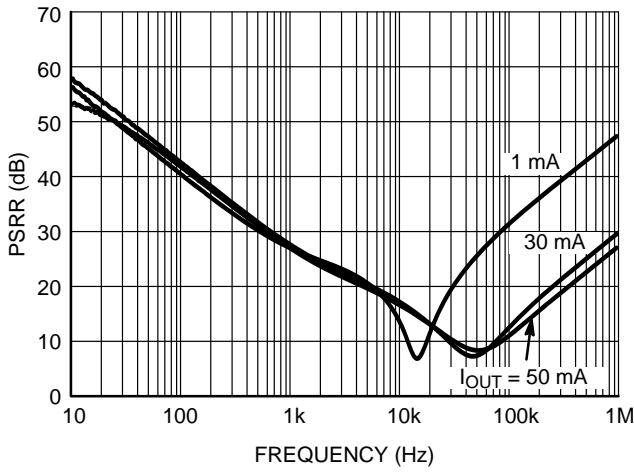

Figure 21. PSRR vs. Frequency, 1.2 V Version

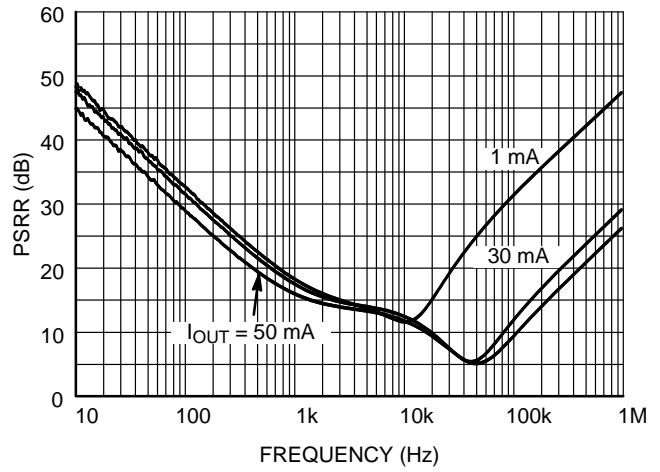

Figure 22. PSRR vs. Frequency, 3.3 V Version

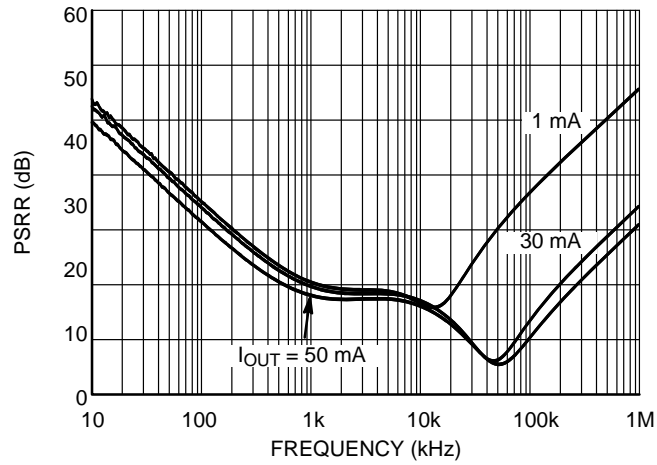

Figure 23. PSRR vs. Frequency, 5.5 V Version

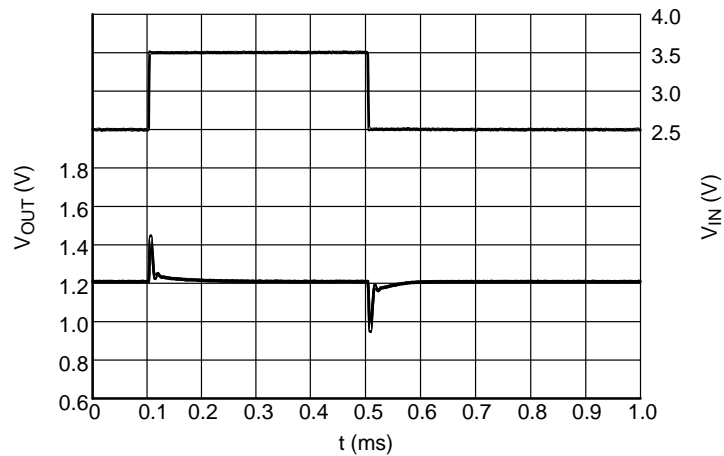

Figure 24. Line Transients, 1.2 V Version,
 $I_{OUT} = 1 \text{ mA}$

NCP4624

TYPICAL CHARACTERISTICS

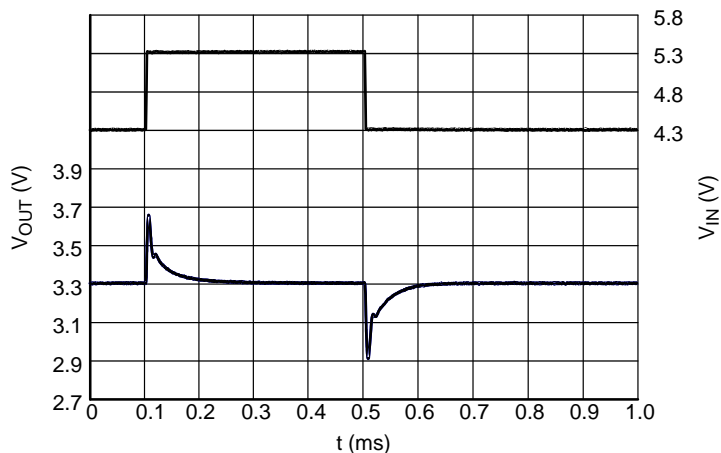

Figure 25. Line Transients, 3.3 V Version,
 $I_{OUT} = 1 \text{ mA}$

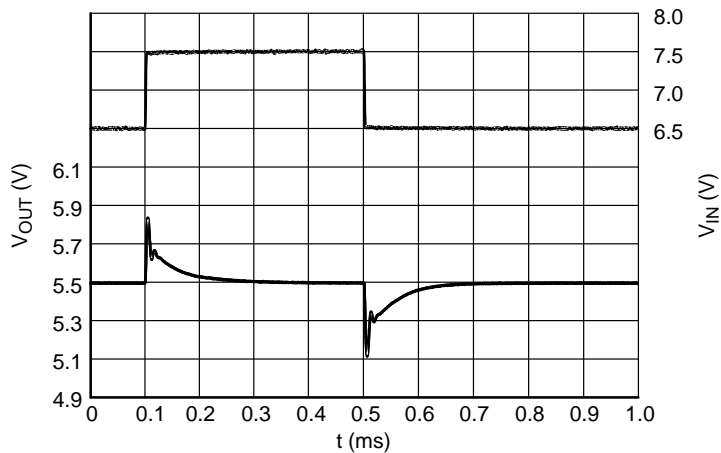

Figure 26. Line Transients, 5.5 V Version,
 $I_{OUT} = 1 \text{ mA}$

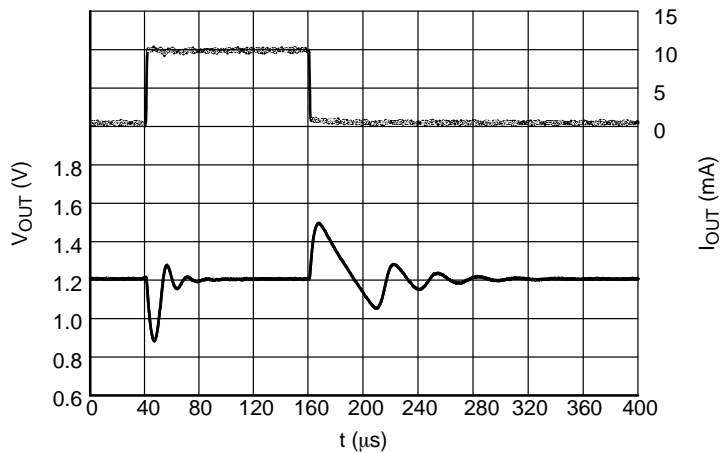

Figure 27. Load Transients, 1.2 V Version, Load
Step 1 mA to 10 mA,
 $V_{IN} = 2.5 \text{ V}$

NCP4624

TYPICAL CHARACTERISTICS

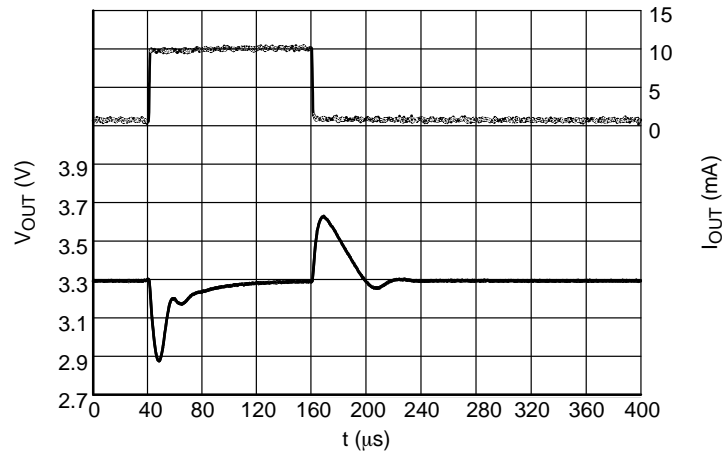

Figure 28. Load Transients, 3.3 V Version, Load Step 1 mA to 10 mA, $V_{IN} = 4.3$ V

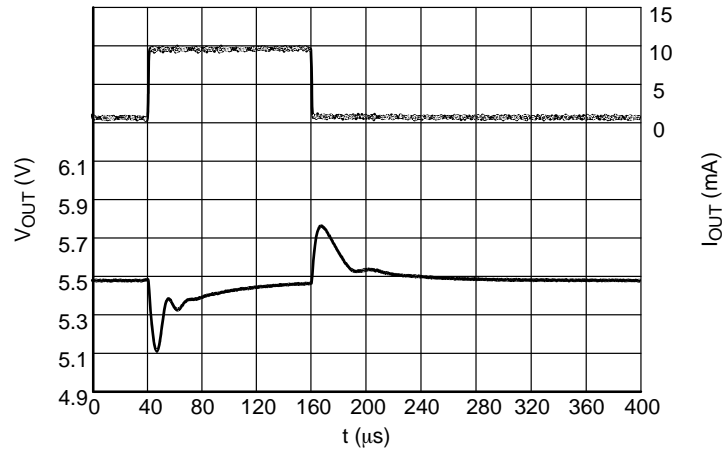

Figure 29. Load Transients, 5.5 V Version, Load Step 1 mA to 10 mA, $V_{IN} = 6.5$ V

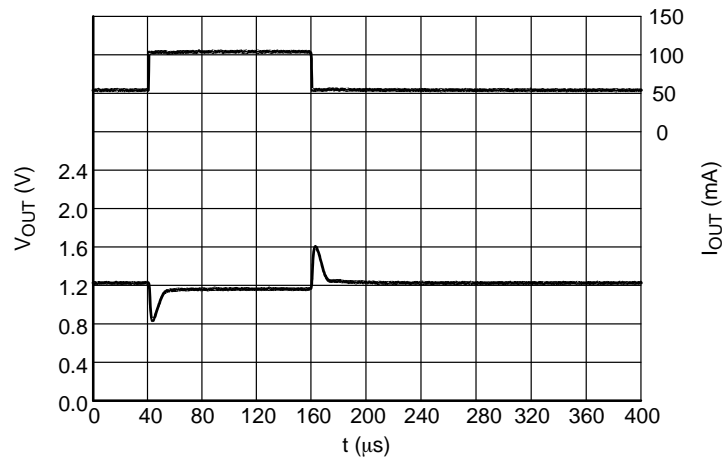

Figure 30. Load Transients, 1.2 V Version, Load Step 50 mA to 100 mA, $V_{IN} = 2.5$ V

NCP4624

TYPICAL CHARACTERISTICS

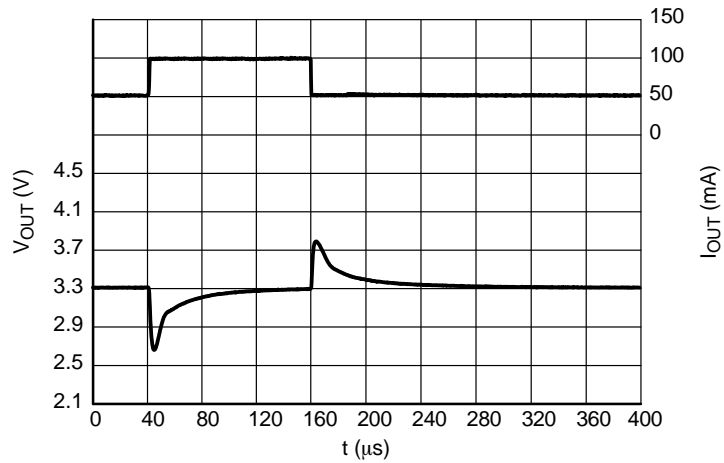

Figure 31. Load Transients, 3.3 V Version, Load Step 50 mA to 100 mA, $V_{IN} = 4.3 V$

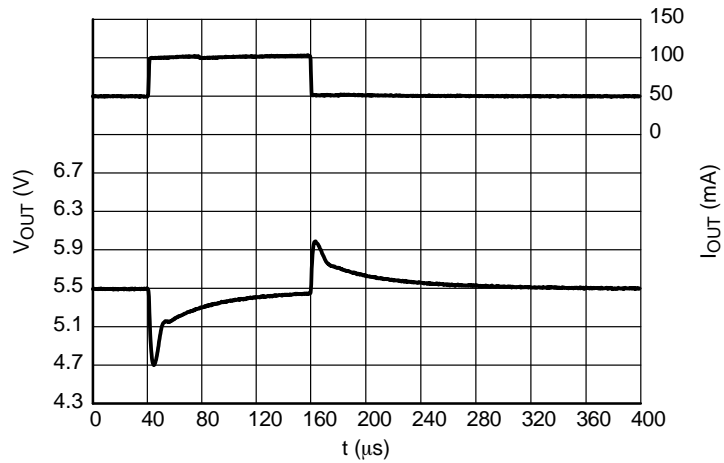

Figure 32. Load Transients, 5.5 V Version, Load Step 50 mA to 100 mA, $V_{IN} = 6.5 V$

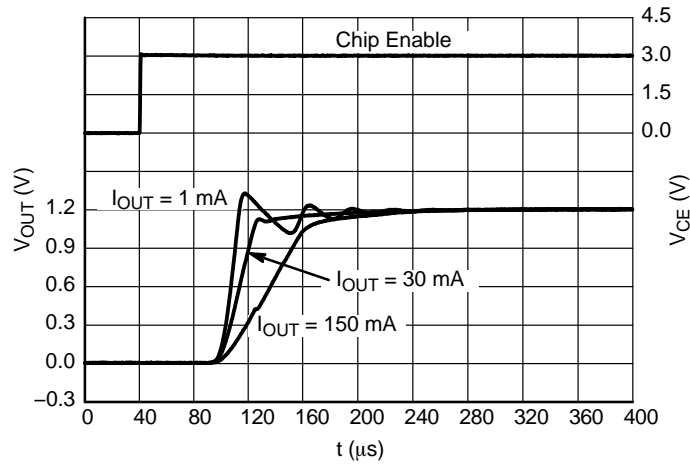

Figure 33. Turn-on Behavior, 1.2 Version, $V_{IN} = 3 V$

NCP4624

TYPICAL CHARACTERISTICS

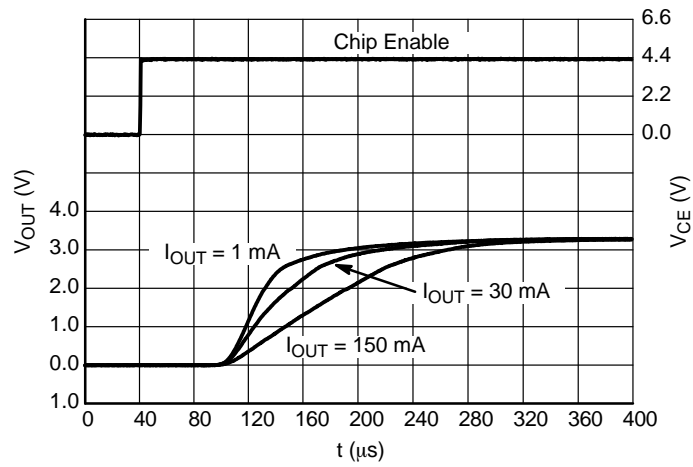

Figure 34. Turn-on Behavior, 3.3 Version,
 $V_{IN} = 4.3 \text{ V}$

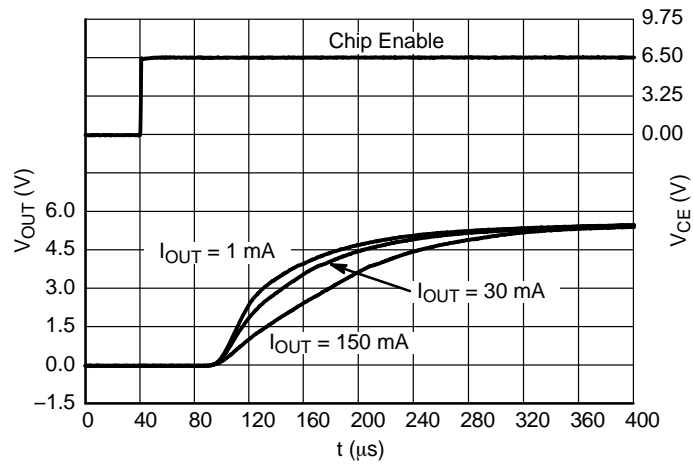

Figure 35. Turn-on Behavior, 5.5 Version,
 $V_{IN} = 6.5 \text{ V}$

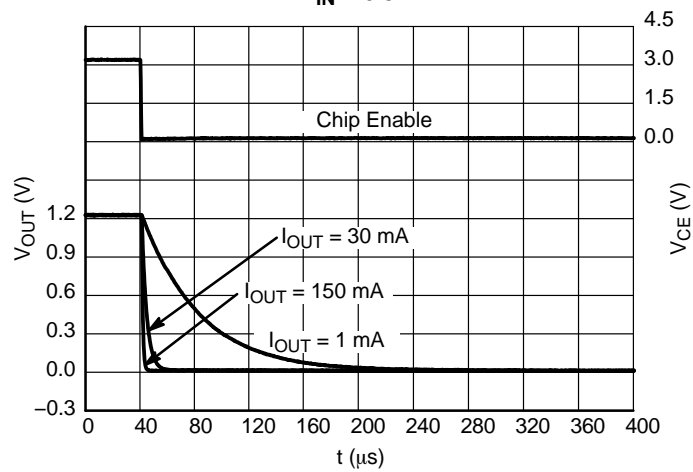

Figure 36. Turn-off Behavior, 1.2 Version,
 $V_{IN} = 3 \text{ V}$

NCP4624

TYPICAL CHARACTERISTICS

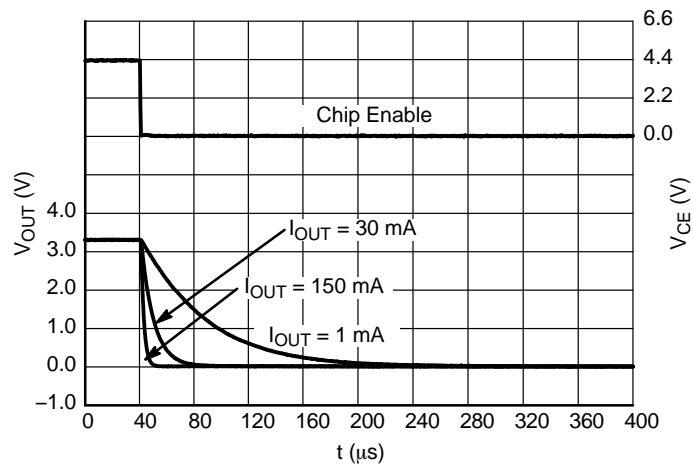

Figure 37. Turn-off Behavior, 3.3 Version,
 $V_{IN} = 4.3$ V

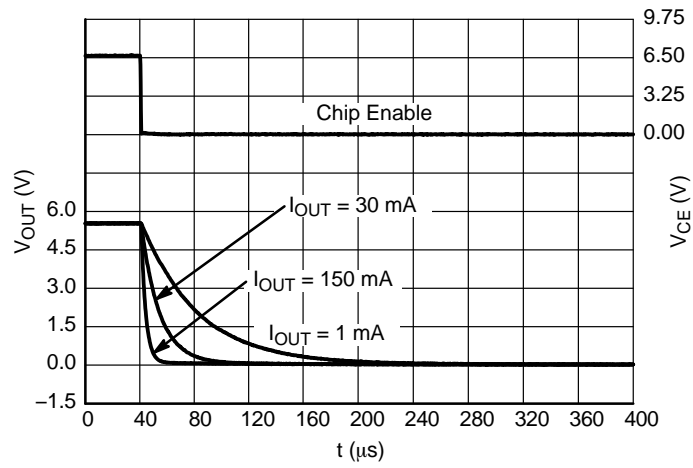

Figure 38. Turn-off Behavior, 5.5 Version,
 $V_{IN} = 6.5$ V

APPLICATION INFORMATION

A typical application circuit for NCP4624 series is shown in the Figure 39.

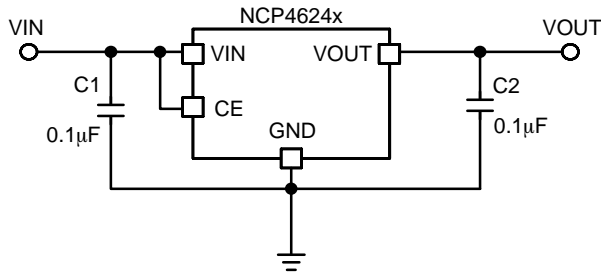

Figure 39. Typical Application Schematic

Input Decoupling Capacitor (C1)

A 100 nF ceramic input decoupling capacitor should be connected as close as possible to the input and ground pin of the NCP4624. Higher values and lower ESR improves line transient response.

Output Decoupling Capacitor (C2)

A 100 nF ceramic output decoupling capacitor is sufficient to achieve stable operation of the IC. If tantalum capacitor is used, and its ESR is high, the loop oscillation may result. The capacitor should be connected as close as possible to the output and ground pin. Larger values and lower ESR improves dynamic parameters.

Enable Operation

The enable pin CE may be used for turning the regulator on and off. The IC is switched on when a high level voltage is applied to the CE pin. The enable pin has an internal pull

down current source which assure off state of LDO in case the CE pin will stay floating. If the enable function is not needed connect CE pin to VIN.

The D version of the NCP4624 includes a transistor between VOUT and GND that is used for faster discharging of the output capacitor. This function is activated when the IC goes into disable mode.

Thermal Consideration

As a power across the IC increase, it might become necessary to provide some thermal relief. The maximum power dissipation supported by the device is dependent upon board design and layout. Mounting pad configuration on the PCB, the board material, and also the ambient temperature affect the rate of temperature increase for the part. When the device has good thermal conductivity through the PCB the junction temperature will be relatively low in high power dissipation applications.

Reverse Current Protection Circuit

Internal Reverse Current Circuitry stops the reverse current from VOUT pin to GND pin and VIN pin when VOUT goes higher than VIN voltage or VSET voltage. VSET means voltage given by voltage version. The parasitic diode of PMOS pass device is internally switched to reverse direction before VIN becomes lower than VOUT. The operation coverage of the Reverse Current Protection Circuit is VOUT > 1.5 V. In order to avoid unstable behavior a hysteresis is created by different threshold of detecting voltage VREV_DET and releasing voltage VREV_REL. See Figures 40 and 41 for details of configuration.

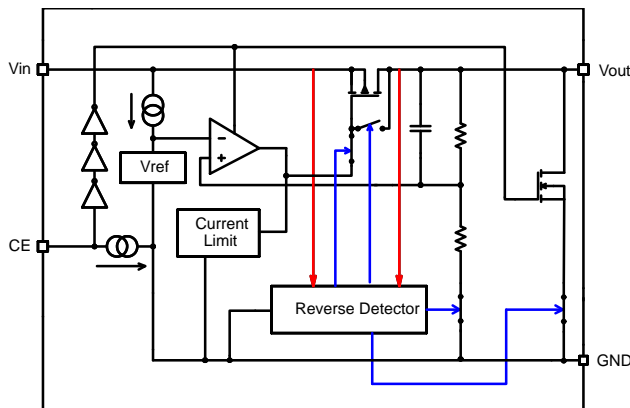

Figure 40. Normal Operating Mode

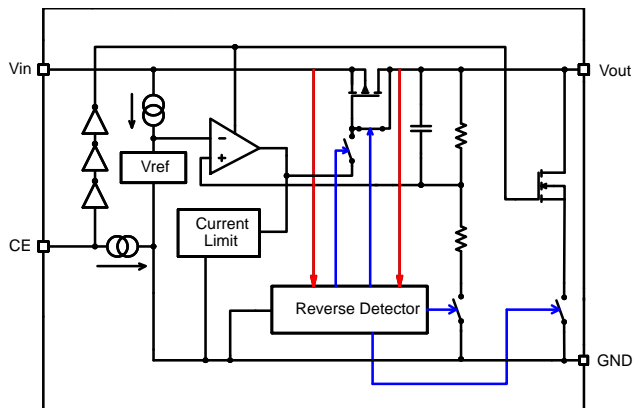

Figure 41. Reverse Current Protection Mode

NCP4624

ESR versus Output Current

When using the NCP4624 devices, consider the following points:

- The relation between Output Current I_{OUT} and ESR of the output capacitor are shown below in Figures 42, 43 and 44.

- The conditions when the device performs stable operation are marked as the hatched area in the charts.

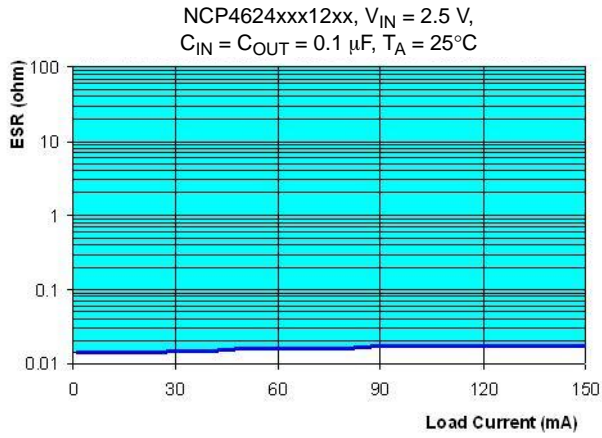

Figure 42. ESR vs. Load Current

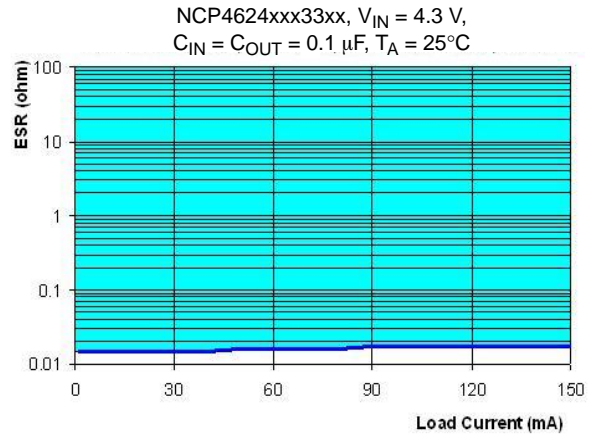

Figure 43. ESR vs. Load Current

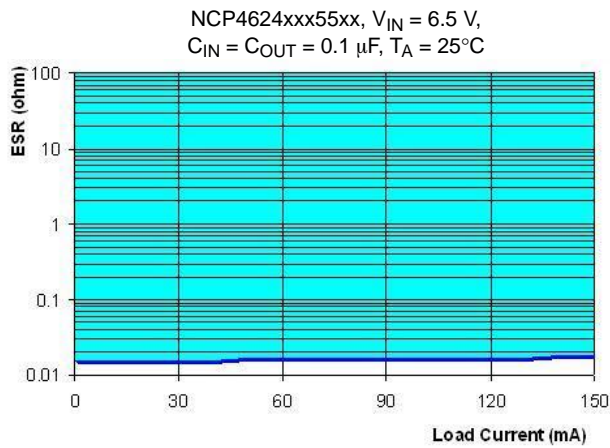

Figure 44. ESR vs. Load Current

NCP4624

ORDERING INFORMATION

Device	Marking	Nominal Output Voltage	Feature	Package	Shipping
NCP4624DMU12TCG	5A	1.2 V	Enable High,	DFN1010 (Pb-Free)	10000 / Tape & Reel
			Auto discharge		
NCP4624DMU30TCG	5X	3.0 V	Enable High,	DFN1010 (Pb-Free)	10000 / Tape & Reel
			Auto discharge		
NCP4624DMU33TCG	6A	3.3 V	Enable High,	DFN1010 (Pb-Free)	10000 / Tape & Reel
			Auto discharge		
NCP4624DMU50TCG	6T	5.0 V	Enable High,	DFN1010 (Pb-Free)	10000 / Tape & Reel
			Auto discharge		
NCP4624DSN12T1G	F12	1.2 V	Enable High,	SOT-23-5 (Pb-Free)	3000 / Tape & Reel
			Auto discharge		
NCP4624DSN18T1G	F18	1.8 V	Enable High,	SOT-23-5 (Pb-Free)	3000 / Tape & Reel
			Auto discharge		
NCP4624DSN33T1G	F33	3.3 V	Enable High,	SOT-23-5 (Pb-Free)	3000 / Tape & Reel
			Auto discharge		
NCP4624DSN50T1G	F50	5.0 V	Enable High,	SOT-23-5 (Pb-Free)	3000 / Tape & Reel
			Auto discharge		
NCP4624DSQ12T1G	AT12	1.2 V	Enable High,	SC-88A (Pb-Free)	3000 / Tape & Reel
			Auto discharge		
NCP4624DSQ33T1G	AT33	3.3 V	Enable High,	SC-88A (Pb-Free)	3000 / Tape & Reel
			Auto discharge		

†For information on tape and reel specifications, including part orientation and tape sizes, please refer to our Tape and Reel Packaging Specifications Brochure, BRD8011/D.

NCP4624

PACKAGE DIMENSIONS

SOT-23 5-LEAD CASE 1212 ISSUE A

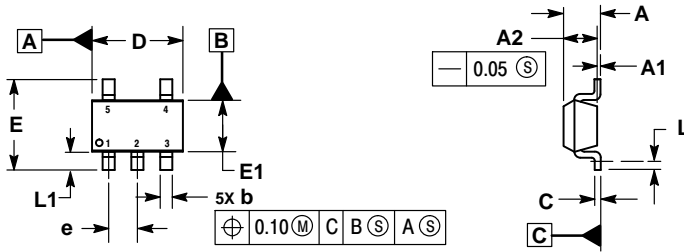

NOTES:

1. DIMENSIONING AND TOLERANCING PER ASME Y14.5M, 1994.
2. CONTROLLING DIMENSIONS: MILLIMETERS.
3. DATUM C IS THE SEATING PLANE.

MILLIMETERS		
DIM	MIN	MAX
A	---	1.45
A1	0.00	0.10
A2	1.00	1.30
b	0.30	0.50
c	0.10	0.25
D	2.70	3.10
E	2.50	3.10
E1	1.50	1.80
e	0.95 BSC	
L	0.20	---
L1	0.45	0.75

RECOMMENDED SOLDERING FOOTPRINT*

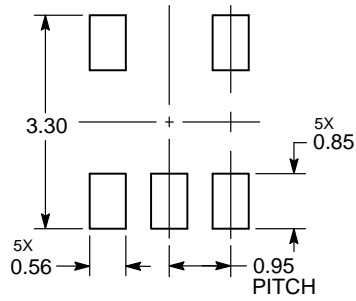

DIMENSIONS: MILLIMETERS

*For additional information on our Pb-Free strategy and soldering details, please download the ON Semiconductor Soldering and Mounting Techniques Reference Manual, SOLDERRM/D.

NCP4624

PACKAGE DIMENSIONS

UDFN4 1.0x1.0, 0.65P
CASE 517BR
ISSUE O

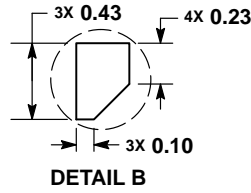
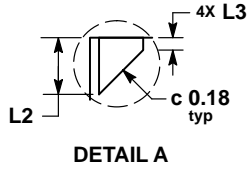
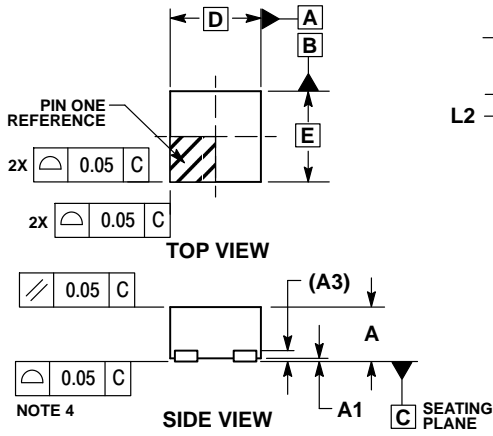

NOTES:

1. DIMENSIONING AND TOLERANCING PER ASME Y14.5M, 1994.
2. CONTROLLING DIMENSION: MILLIMETERS.
3. DIMENSION b APPLIES TO PLATED TERMINAL AND IS MEASURED BETWEEN 0.15 AND 0.20 mm FROM TERMINAL.
4. COPLANARITY APPLIES TO THE EXPOSED PAD AS WELL AS THE TERMINALS.

MILLIMETERS		
DIM	MIN	MAX
A	—	0.60
A1	0.00	0.05
A3	0.10	REF
b	0.20	0.30
D	1.00	BSC
D2	0.43	0.53
E	1.00	BSC
e	0.65	BSC
L	0.20	0.30
L2	0.27	0.37
L3	0.02	0.12

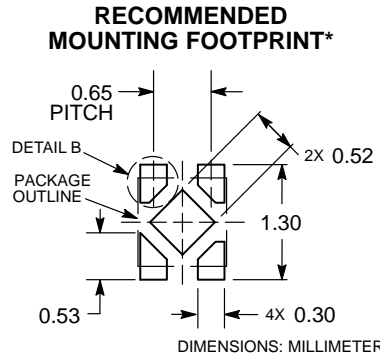
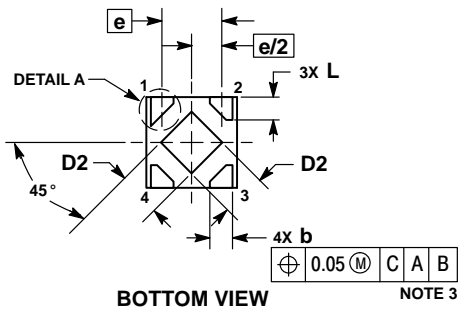

*For additional information on our Pb-Free strategy and soldering details, please download the ON Semiconductor Soldering and Mounting Techniques Reference Manual, SOLDERRM/D.

NCP4624

PACKAGE DIMENSIONS

SC-88A (SC-70-5/SOT-353)
CASE 419A-02
ISSUE L

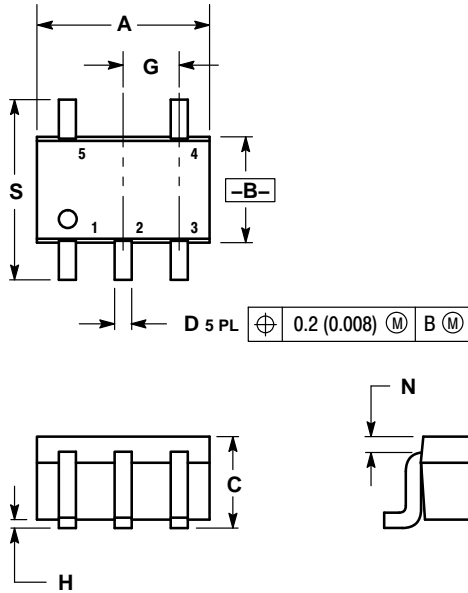



NOTES:

1. DIMENSIONING AND TOLERANCING PER ANSI Y14.5M, 1982.
2. CONTROLLING DIMENSION: INCH.
3. 419A-01 OBSOLETE. NEW STANDARD 419A-02.
4. DIMENSIONS A AND B DO NOT INCLUDE MOLD FLASH, PROTRUSIONS, OR GATE BURRS.

DIM	INCHES		MILLIMETERS	
	MIN	MAX	MIN	MAX
A	0.071	0.087	1.80	2.20
B	0.045	0.053	1.15	1.35
C	0.031	0.043	0.80	1.10
D	0.004	0.012	0.10	0.30
G	0.026 BSC		0.65 BSC	
H	---	0.004	---	0.10
J	0.004	0.010	0.10	0.25
K	0.004	0.012	0.10	0.30
N	0.008 REF		0.20 REF	
S	0.079	0.087	2.00	2.20

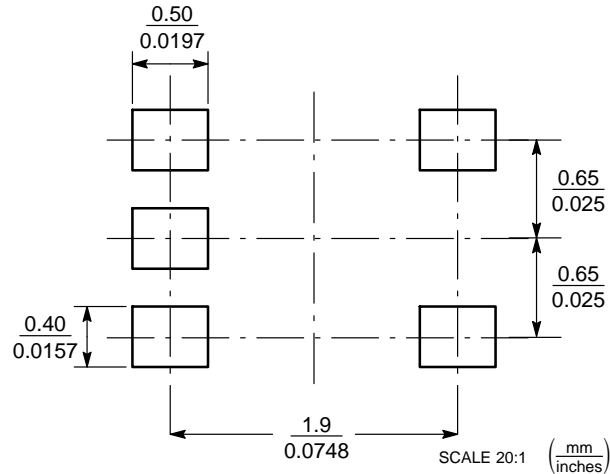
SOLDER FOOTPRINT



ON Semiconductor and the  are registered trademarks of Semiconductor Components Industries, LLC (SCILLC) or its subsidiaries in the United States and/or other countries. SCILLC owns the rights to a number of patents, trademarks, copyrights, trade secrets, and other intellectual property. A listing of SCILLC's product/patent coverage may be accessed at www.onsemi.com/site/pdf/Patent-Marking.pdf. SCILLC reserves the right to make changes without further notice to any products herein. SCILLC makes no warranty, representation or guarantee regarding the suitability of its products for any particular purpose, nor does SCILLC assume any liability arising out of the application or use of any product or circuit, and specifically disclaims any and all liability, including without limitation special, consequential or incidental damages. "Typical" parameters which may be provided in SCILLC data sheets and/or specifications can and do vary in different applications and actual performance may vary over time. All operating parameters, including "Typicals" must be validated for each customer application by customer's technical experts. SCILLC does not convey any license under its patent rights nor the rights of others. SCILLC products are not designed, intended, or authorized for use as components in systems intended for surgical implant into the body, or other applications intended to support or sustain life, or for any other application in which the failure of the SCILLC product could create a situation where personal injury or death may occur. Should Buyer purchase or use SCILLC products for any such unintended or unauthorized application, Buyer shall indemnify and hold SCILLC and its officers, employees, subsidiaries, affiliates, and distributors harmless against all claims, costs, damages, and expenses, and reasonable attorney fees arising out of, directly or indirectly, any claim of personal injury or death associated with such unintended or unauthorized use, even if such claim alleges that SCILLC was negligent regarding the design or manufacture of the part. SCILLC is an Equal Opportunity/Affirmative Action Employer. This literature is subject to all applicable copyright laws and is not for resale in any manner.

PUBLICATION ORDERING INFORMATION

LITERATURE FULFILLMENT:

Literature Distribution Center for ON Semiconductor
P.O. Box 5163, Denver, Colorado 80217 USA
Phone: 303-675-2175 or 800-344-3860 Toll Free USA/Canada
Fax: 303-675-2176 or 800-344-3867 Toll Free USA/Canada
Email: orderlit@onsemi.com

N. American Technical Support: 800-282-9855 Toll Free
USA/Canada
Europe, Middle East and Africa Technical Support:
Phone: 421 33 790 2910
Japan Customer Focus Center
Phone: 81-3-5817-1050

ON Semiconductor Website: www.onsemi.com

Order Literature: <http://www.onsemi.com/orderlit>

For additional information, please contact your local Sales Representative

Mouser Electronics

Authorized Distributor

Click to View Pricing, Inventory, Delivery & Lifecycle Information:

ON Semiconductor:

[NCP4624DMU12TCG](#) [NCP4624DMU33TCG](#) [NCP4624DSN33T1G](#) [NCP4624DSQ33T1G](#) [NCP4624DSN12T1G](#)
[NCP4624DSN50T1G](#) [NCP4624DSQ12T1G](#) [NCP4624DMU30TCG](#) [NCP4624DSN18T1G](#) [NCP4624DMU50TCG](#)