

# NTS260ESF, NRVTS260ESF

## Very Low Forward Voltage Trench-based Schottky Rectifier

### Features

- Fine Lithography Trench-based Schottky Technology for Very Low Forward Voltage and Low Leakage
- Fast Switching with Exceptional Temperature Stability
- Low Power Loss and Lower Operating Temperature
- Higher Efficiency for Achieving Regulatory Compliance
- Low Thermal Resistance
- High Surge Capability
- NRV Prefix for Automotive and Other Applications Requiring Unique Site and Control Change Requirements; AEC-Q101 Qualified and PPAP Capable
- These are Pb-Free and Halide-Free Devices

### Mechanical Characteristics:

- Case: Molded Epoxy
- Epoxy Meets UL 94 V-0 @ 0.125 in
- Weight: 11.7 mg (Approximately)
- Lead and Mounting Surface Temperature for Soldering Purposes: 260°C Maximum for 10 Seconds
- MSL 1

### Typical Applications

- Switching Power Supplies including Compact Adapters and Flat Panel Display
- High Frequency and DC-DC Converters
- Freewheeling and OR-ing diodes
- Reverse Battery Protection
- Instrumentation



ON Semiconductor®

[www.onsemi.com](http://www.onsemi.com)

**TRENCH SCHOTTKY  
RECTIFIER  
2.0 AMPERES  
60 VOLTS**

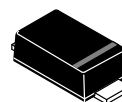

**SOD-123FL  
CASE 498  
PLASTIC**

### MARKING DIAGRAM

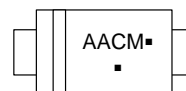

AAC = Specific Device Code  
M = Date Code  
▪ = Pb-Free Package  
(Note: Microdot may be in either location)

### ORDERING INFORMATION

Device	Package	Shipping†
NTS260ESFT3G	SOD-123FL (Pb-Free)	10,000/ Tape & Reel
NRVTS260ESFT3G	SOD-123FL (Pb-Free)	10,000/ Tape & Reel
NTS260ESFT1G	SOD-123FL (Pb-Free)	3,000/ Tape & Reel
NRVTS260ESFT1G	SOD-123FL (Pb-Free)	3,000/ Tape & Reel

†For information on tape and reel specifications, including part orientation and tape sizes, please refer to our Tape and Reel Packaging Specification Brochure, BRD8011/D.

# NTS260ESF, NRVTS260ESF

## MAXIMUM RATINGS

Rating	Symbol	Value	Unit
Peak Repetitive Reverse Voltage Working Peak Reverse Voltage DC Blocking Voltage	$V_{RRM}$ $V_{RWM}$ $V_R$	60	V
Average Rectified Forward Current ( $T_L = TBD^{\circ}C$ )	$I_O$	2.0	A
Peak Repetitive Forward Current (Square Wave, 20 kHz, $T_L = TBD^{\circ}C$ )	$I_{FRM}$	4.0	A
Non-Repetitive Peak Surge Current (Surge Applied at Rated Load Conditions Halfwave, Single Phase, 60 Hz)	$I_{FSM}$	25	A
Storage and Operating Junction Temperature Range (Note 1)	$T_{stg}, T_J$	-65 to +175	$^{\circ}C$

Stresses exceeding those listed in the Maximum Ratings table may damage the device. If any of these limits are exceeded, device functionality should not be assumed, damage may occur and reliability may be affected.

- The heat generated must be less than the thermal conductivity from Junction-to-Ambient:  $dP_D/dT_J < 1/R_{\theta JA}$ .

## THERMAL CHARACTERISTICS

Characteristic	Symbol	Value	Unit
Thermal Resistance, Junction-to-Lead (Note 2)	$\Psi_{JCL}$	24.4	$^{\circ}C/W$
Thermal Resistance, Junction-to-Ambient (Note 2)	$R_{\theta JA}$	85	$^{\circ}C/W$
Thermal Resistance, Junction-to-Ambient (Note 3)	$R_{\theta JA}$	330	$^{\circ}C/W$

## ELECTRICAL CHARACTERISTICS

Characteristic	Symbol	Value	Unit
Maximum Instantaneous Forward Voltage (Note 4) ( $I_F = 1.0 A, T_J = 25^{\circ}C$ ) ( $I_F = 2.0 A, T_J = 25^{\circ}C$ ) ( $I_F = 1.0 A, T_J = 125^{\circ}C$ ) ( $I_F = 2.0 A, T_J = 125^{\circ}C$ )	$V_F$	0.55 0.65 0.47 0.58	V
Maximum Instantaneous Reverse Current (Note 4) (Rated dc Voltage, $T_J = 25^{\circ}C$ ) (Rated dc Voltage, $T_J = 125^{\circ}C$ )	$I_R$	12 3	$\mu A$ mA

Product parametric performance is indicated in the Electrical Characteristics for the listed test conditions, unless otherwise noted. Product performance may not be indicated by the Electrical Characteristics if operated under different conditions.

- Mounted with 700 mm<sup>2</sup> copper pad size (Approximately 1 in<sup>2</sup>) 1 oz FR4 Board.
- Mounted with pad size approximately 20 mm<sup>2</sup> copper, 1 oz FR4 Board.
- Pulse Test: Pulse Width  $\leq 380 \mu s$ , Duty Cycle  $\leq 2.0\%$ .

# NTS260ESF, NRVT260ESF

## TYPICAL CHARACTERISTICS

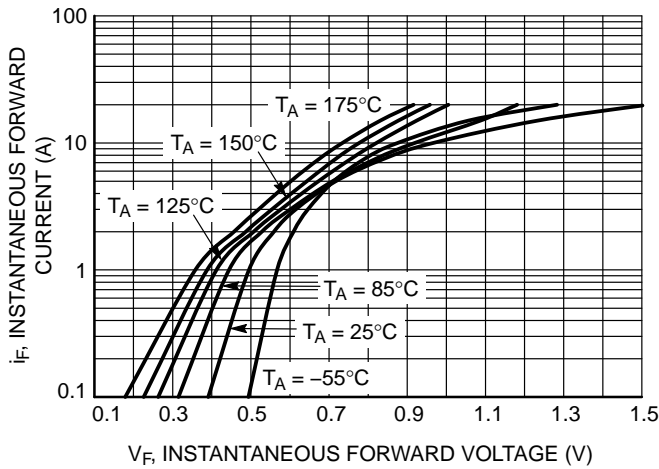

**Figure 1. Typical Instantaneous Forward Characteristics**

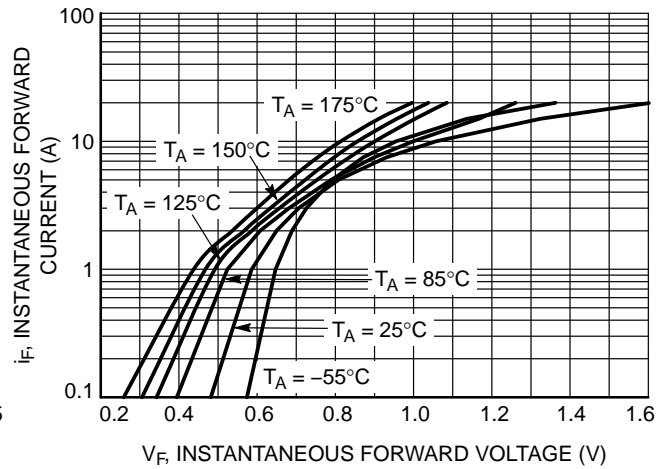

**Figure 2. Maximum Instantaneous Forward Characteristics**

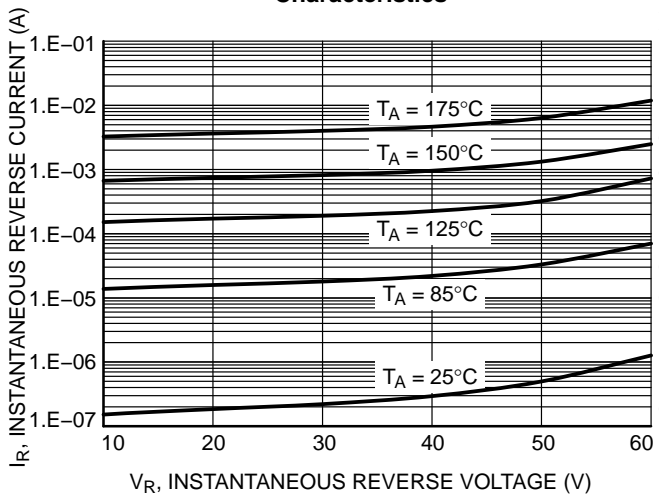

**Figure 3. Typical Reverse Characteristics**

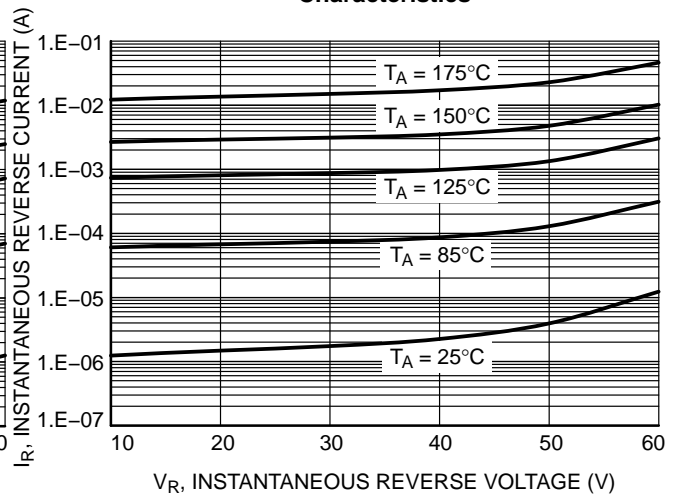

**Figure 4. Maximum Reverse Characteristics**

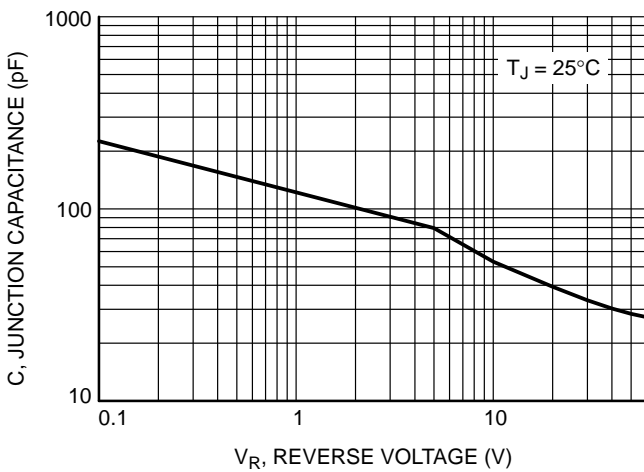

**Figure 5. Typical Junction Capacitance**

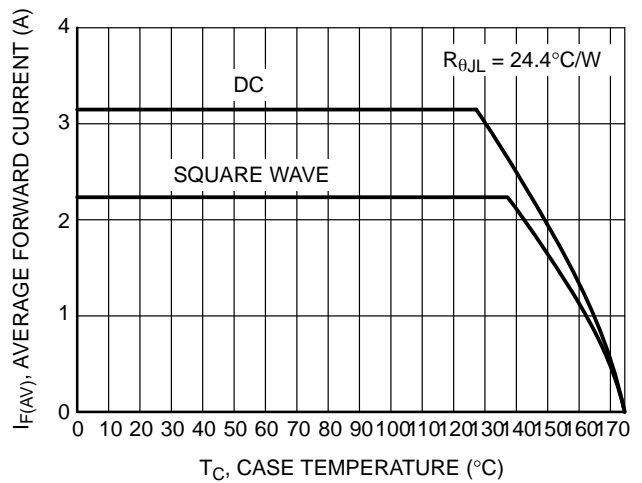
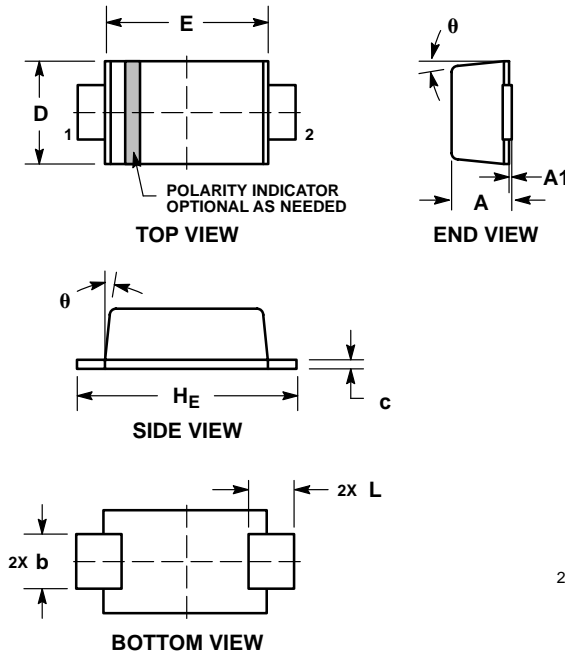

**Figure 6. Current Derating**

# NTS260ESF, NRVTS260ESF

## PACKAGE DIMENSIONS

SOD-123FL  
CASE 498  
ISSUE D



**NOTES:**

1. DIMENSIONING AND TOLERANCING PER ANSI Y14.5M, 1982.
2. CONTROLLING DIMENSION: MILLIMETER.
3. DIMENSIONS A AND B DO NOT INCLUDE MOLD FLASH.
4. DIMENSIONS D AND J ARE TO BE MEASURED ON FLAT SECTION OF THE LEAD: BETWEEN 0.10 AND 0.25 MM FROM THE LEAD TIP.

DIM	MILLIMETERS			INCHES		
	MIN	NOM	MAX	MIN	NOM	MAX
A	0.90	0.95	0.98	0.035	0.037	0.039
A1	0.00	0.05	0.10	0.000	0.002	0.004
b	0.70	0.90	1.10	0.028	0.035	0.043
c	0.10	0.15	0.20	0.004	0.006	0.008
D	1.50	1.65	1.80	0.059	0.065	0.071
E	2.50	2.70	2.90	0.098	0.106	0.114
L	0.55	0.75	0.95	0.022	0.030	0.037
HE	3.40	3.60	3.80	0.134	0.142	0.150
θ	0°	-	8°	0°	-	8°

### RECOMMENDED SOLDERING FOOTPRINT\*

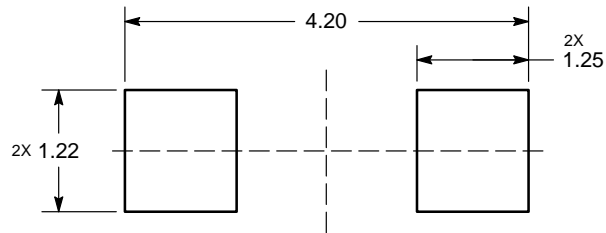

DIMENSIONS: MILLIMETERS

\*For additional information on our Pb-Free strategy and soldering details, please download the ON Semiconductor Soldering and Mounting Techniques Reference Manual, SOLDERRM/D.

ON Semiconductor and the  are registered trademarks of Semiconductor Components Industries, LLC (SCILLC) or its subsidiaries in the United States and/or other countries. SCILLC owns the rights to a number of patents, trademarks, copyrights, trade secrets, and other intellectual property. A listing of SCILLC's product/patent coverage may be accessed at [www.onsemi.com/site/pdf/Patent-Marking.pdf](http://www.onsemi.com/site/pdf/Patent-Marking.pdf). SCILLC reserves the right to make changes without further notice to any products herein. SCILLC makes no warranty, representation or guarantee regarding the suitability of its products for any particular purpose, nor does SCILLC assume any liability arising out of the application or use of any product or circuit, and specifically disclaims any and all liability, including without limitation special, consequential or incidental damages. "Typical" parameters which may be provided in SCILLC data sheets and/or specifications can and do vary in different applications and actual performance may vary over time. All operating parameters, including "Typicals" must be validated for each customer application by customer's technical experts. SCILLC does not convey any license under its patent rights nor the rights of others. SCILLC products are not designed, intended, or authorized for use as components in systems intended for surgical implant into the body, or other applications intended to support or sustain life, or for any other application in which the failure of the SCILLC product could create a situation where personal injury or death may occur. Should Buyer purchase or use SCILLC products for any such unintended or unauthorized application, Buyer shall indemnify and hold SCILLC and its officers, employees, subsidiaries, affiliates, and distributors harmless against all claims, costs, damages, and expenses, and reasonable attorney fees arising out of, directly or indirectly, any claim of personal injury or death associated with such unintended or unauthorized use, even if such claim alleges that SCILLC was negligent regarding the design or manufacture of the part. SCILLC is an Equal Opportunity/Affirmative Action Employer. This literature is subject to all applicable copyright laws and is not for resale in any manner.

### PUBLICATION ORDERING INFORMATION

**LITERATURE FULFILLMENT:**

Literature Distribution Center for ON Semiconductor  
P.O. Box 5163, Denver, Colorado 80217 USA  
Phone: 303-675-2175 or 800-344-3860 Toll Free USA/Canada  
Fax: 303-675-2176 or 800-344-3867 Toll Free USA/Canada  
Email: [orderlit@onsemi.com](mailto:orderlit@onsemi.com)

**N. American Technical Support:** 800-282-9855 Toll Free  
USA/Canada  
**Europe, Middle East and Africa Technical Support:**  
Phone: 421 33 790 2910  
**Japan Customer Focus Center**  
Phone: 81-3-5817-1050

**ON Semiconductor Website:** [www.onsemi.com](http://www.onsemi.com)

**Order Literature:** <http://www.onsemi.com/orderlit>

For additional information, please contact your local Sales Representative

# Mouser Electronics

Authorized Distributor

Click to View Pricing, Inventory, Delivery & Lifecycle Information:

[ON Semiconductor:](#)

[NRVTS260ESFT1G](#) [NRVTS260ESFT3G](#)