

CMOS LDO Regulators for Automotive Equipments

1ch 200mA CMOS LDO Regulators



BUxxSD2-M series

● **General Description**

BUxxSD2-M series are high-performance CMOS LDO regulators with output current ability of up to 200-mA. These devices have excellent noise and load response characteristics despite of its low circuit current consumption of 33μA. They are most appropriate for various applications such as power supplies for logic IC, RF, and camera modules.

● **Features**

- High Output Voltage Accuracy: ±2.0% (In all recommended conditions)
- High Ripple Rejection: 68 dB (Typ, 1 kHz,)
- Compatible with small ceramic capacitor (Cin=Cout=0.47 μF)
- Low Current Consumption: 33 μA
- Output Voltage ON/OFF control
- Built-in Over Current Protection Circuit (OCP)
- Built-in Thermal Shutdown Circuit (TSD)
- Package SSOP5 is similar to SOT23-5(JEDEC)

● **Applications**

- Automotive equipments.
- Portable devices
- Camera modules
- Other electronic devices using microcontrollers or logic circuits
- AEC-Q100 qualified

● **Typical Application Circuit**

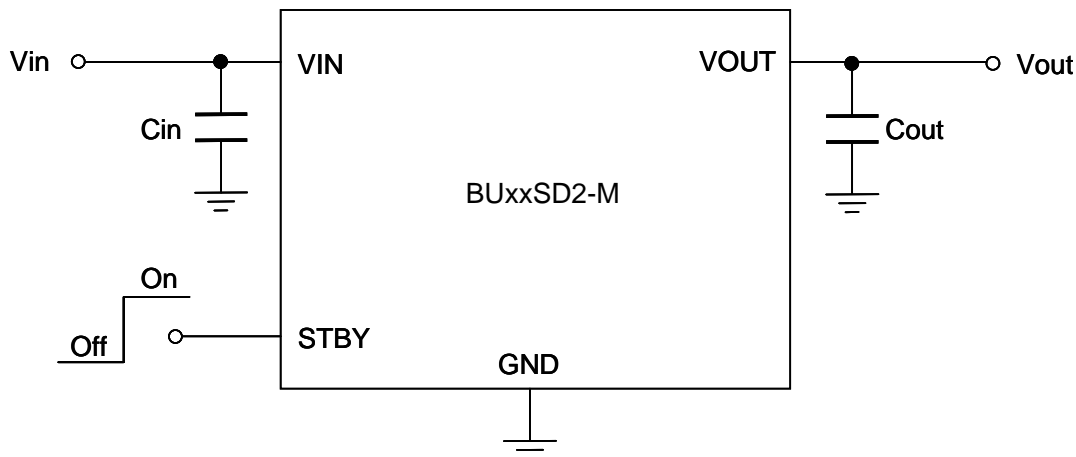

Figure 1. Typical Application Circuit

● **Key Specifications**

- Input Power Supply Voltage Range: 1.7V to 6.0V
- Output Current Range: 0 to 200mA
- Operating Temperature Range: -40°C to +105°C
- Output Voltage Lineup: 1.2V,1.5V,1.8V,2.5V
2.8V,3.0V,3.3V
- Output Voltage Accuracy: ±2.0%
- Circuit Current: 33μA(Typ.)
- Standby Current: 0μA (Typ.)

● **Package**
SSOP5

W(Typ.) x D(Typ.) x H(Max.)
2.90mm x 2.80mm x 1.25mm



●Pin Configuration

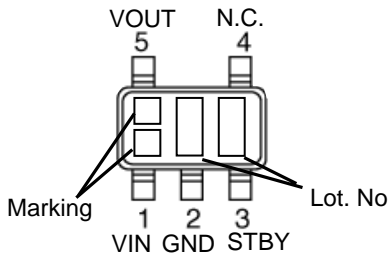

●Pin Description

Pin No.	Symbol	Function
1	VIN	Input Pin
2	GND	GND Pin
3	STBY	Output Control Pin (High:ON, Low:OFF)
4	N.C.	No Connect
5	VOUT	Output Pin

●Block Diagram

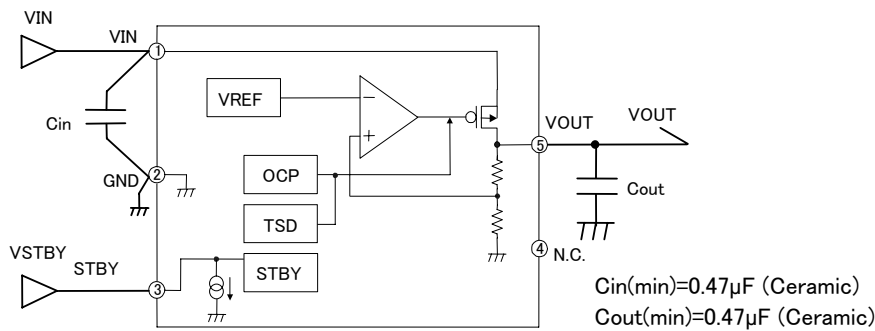

Figure 2. Block diagram

●Absolute Maximum Ratings

Parameter	Symbol	Rating	Unit
Maximum Power Supply Voltage Range	V _{MAX}	-0.3 to +6.5	V
Power Dissipation	P _d	540 ^(*1)	mW
Maximum Junction Temperature	T _{jmax}	+125	°C
Operating Temperature Range	T _{opr}	-40 to +105	°C
Storage Temperature Range	T _{stg}	-55 to +125	°C

(*1) Derate by 5.6mW/°C when operating above T_a=25°C.(When mounted on a board 70mm × 70mm × 1.6mm glass-epoxy board, two layer)

●Recommended Operating Ratings

Parameter	Symbol	Limit	Unit
Input Power Supply Voltage Range	V _{IN}	1.7 to 6.0	V
Maximum Output Current	I _{MAX}	200	mA

●Recommended Operating Conditions

Parameter	Symbol	Rating			Unit	Conditions
		Min.	Typ.	Max.		
Input capacitor	C _{in}	0.47 ^(*2)	1.0	—	μF	A ceramic capacitor is recommended.
Output capacitor	C _{out}	0.47 ^(*2)	1.0	—	μF	A ceramic capacitor is recommended.

(*2) Set the value of the capacitor so that it does not fall below the minimum value. Take into consideration the temperature characteristics, DC device characteristics, and degradation with time.

●Electrical Characteristics

(Unless otherwise noted, $T_a = -40$ to 105°C , $V_{IN} = V_{OUT} + 1.0\text{V}^{(*)3}$, $V_{STBY} = 1.5\text{V}$, $C_{in} = 1\mu\text{F}$, $C_{out} = 1\mu\text{F}$)

PARAMETER	Symbol	Limit			Unit	Conditions	
		MIN.	TYP.	MAX.			
Output Voltage	V_{OUT}	$V_{OUT} \times 0.98$	V_{OUT}	$V_{OUT} \times 1.02$	V	$I_{OUT} = 0$ to 200mA , $V_{OUT} \geq 2.5\text{V}$, $V_{IN} = V_{OUT} + 0.5$ to 6.0V $V_{OUT} < 2.5\text{V}$, $V_{IN} = 3.0$ to 6.0V $T_a = -40$ to $+105^\circ\text{C}$ ^(*4,5,6)	
Line Regulation	V_{DLI}	-	4	10	mV	$I_{OUT} = 10\text{mA}$ $V_{OUT} \leq 2.5\text{V}$, $V_{IN} = 3.0$ to 6.0V	
			6	15	mV	$I_{OUT} = 10\text{mA}$ $V_{OUT} > 2.5\text{V}$, $V_{IN} = V_{OUT} + 0.5$ to 6.0V	
Load Regulation1	V_{DLO1}	-	0.5	5	mV	$I_{OUT} = 1$ to 100mA	
Load Regulation2	V_{DLO2}	-	1	10	mV	$I_{OUT} = 1$ to 200mA	
Dropout Voltage	V_{DROP}	-	400	700	mV	$1.0\text{V} \leq V_{OUT} < 1.2\text{V}$, $I_{OUT} = 100\text{mA}$	
		-	280	550	mV	$1.2\text{V} \leq V_{OUT} < 1.5\text{V}$, $I_{OUT} = 100\text{mA}$	
		-	180	370	mV	$1.5\text{V} \leq V_{OUT} < 1.7\text{V}$, $I_{OUT} = 100\text{mA}$	
		-	150	290	mV	$1.7\text{V} \leq V_{OUT} < 2.1\text{V}$, $I_{OUT} = 100\text{mA}$	
		-	110	220	mV	$2.1\text{V} \leq V_{OUT} < 2.5\text{V}$, $I_{OUT} = 100\text{mA}$	
		-	100	180	mV	$2.5\text{V} \leq V_{OUT} < 2.8\text{V}$, $I_{OUT} = 100\text{mA}$	
		-	85	150	mV	$2.8\text{V} \leq V_{OUT}$, $I_{OUT} = 100\text{mA}$	
Maximum Output Current	I_{OMAX}	200	-	-	mA	$V_{IN} = V_{OUT} + 1.0\text{V}$ ^(*3)	
Limit Current	I_{LMAX}	250	400	-	mA	$V_o = V_{OUT} \times 0.98$, $T_a = 25^\circ\text{C}$	
Short Current	I_{SHORT}	-	100	200	mA	$V_o = 0\text{V}$, $T_a = 25^\circ\text{C}$	
Circuit Current	I_{GND}	-	33	80	μA	$I_{OUT} = 0\text{mA}$	
Circuit Current (STBY)	I_{CCST}	-	-	2.0	μA	$V_{STBY} = 0\text{V}$	
Ripple Rejection Ratio	R.R.	-	68	-	dB	$V_{RR} = -20\text{dB}$, $f_{RR} = 1\text{kHz}$, $I_{OUT} = 10\text{mA}$	
Load Transient Response	V_{LOT}	-	± 65	-	mV	$I_{OUT} = 1$ to 150mA , $T_{rise} = T_{fall} = 1\mu\text{s}$, $V_{IN} = V_{OUT} + 1.0\text{V}$ ^(*5)	
Line Transient Response	V_{LIT}	-	± 5	-	mV	$V_{IN} = V_{OUT} + 0.5$ to $V_{OUT} + 1.0\text{V}$, $T_{rise} = T_{fall} = 10\mu\text{s}$	
Output Noise Voltage	V_{NOIS}	-	30	-	μV_{rms}	Bandwidth 10 to 100kHz	
Startup Time	T_{ST}	-	100	300	μsec	Output Voltage settled within tolerances ^(*7)	
STBY Control Voltage	ON	V_{STBH}	1.1	-	V_{IN}	V	$T_a = 25^\circ\text{C}$
	OFF	V_{STBL}	-0.2	-	0.5	V	
STBY Pin Current	I_{STBY}	-	-	4.0	μA		

(*3) $V_{IN} = 3.5\text{V}$ for $V_{OUT} < 2.5\text{V}$.

(*4) Operating Conditions are limited by P_d .

(*5) Typical values apply for $T_a = 25^\circ\text{C}$.

(*6) $V_{IN} = 3.0\text{V}$ to 6.0V for $V_{OUT} < 2.5\text{V}$.

(*7) Startup time=time from EN assertion to $V_{OUT} \times 0.98$

●Reference data BU12SD2MG-M (Unless otherwise specified, $T_a=25^\circ\text{C}$.)

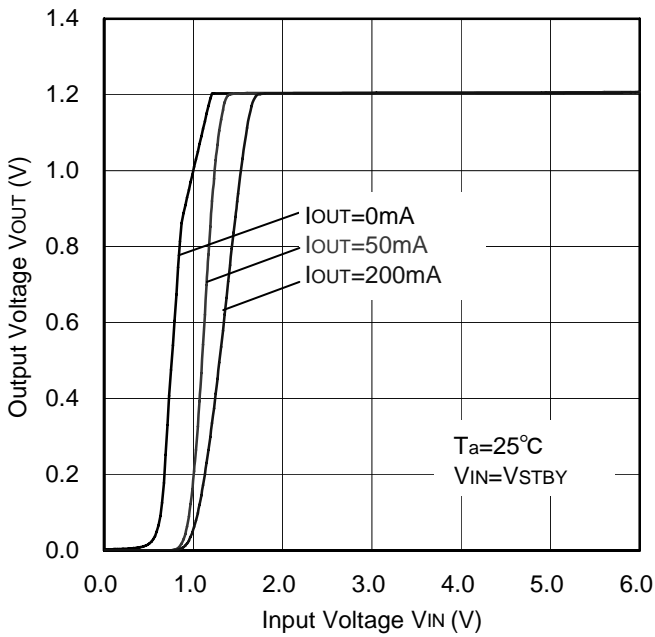

Figure 3. Output Voltage vs. Input Voltage

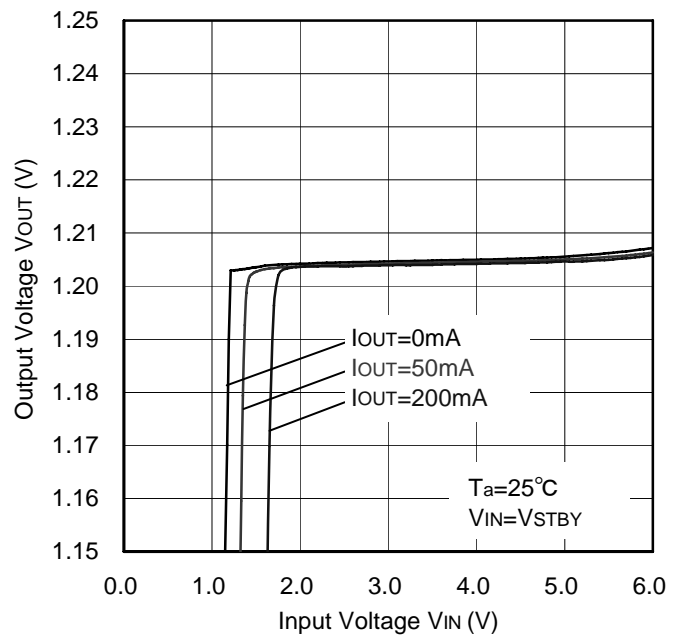

Figure 4. Line Regulation

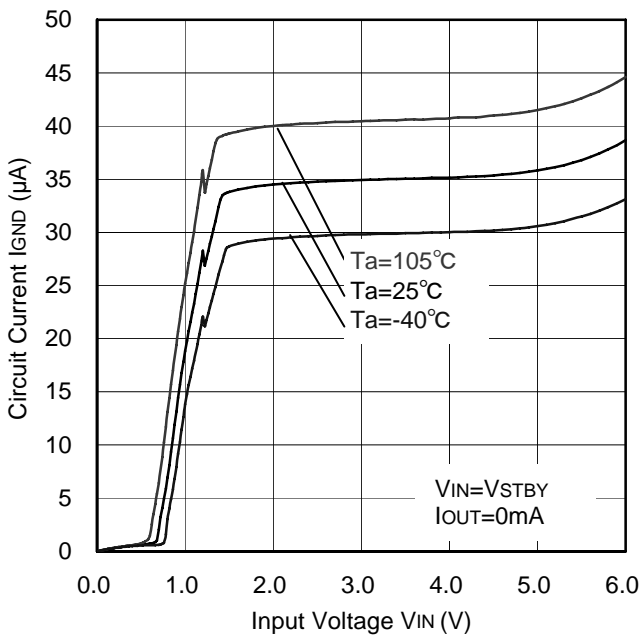

Figure 5. Circuit Current vs. Input Voltage

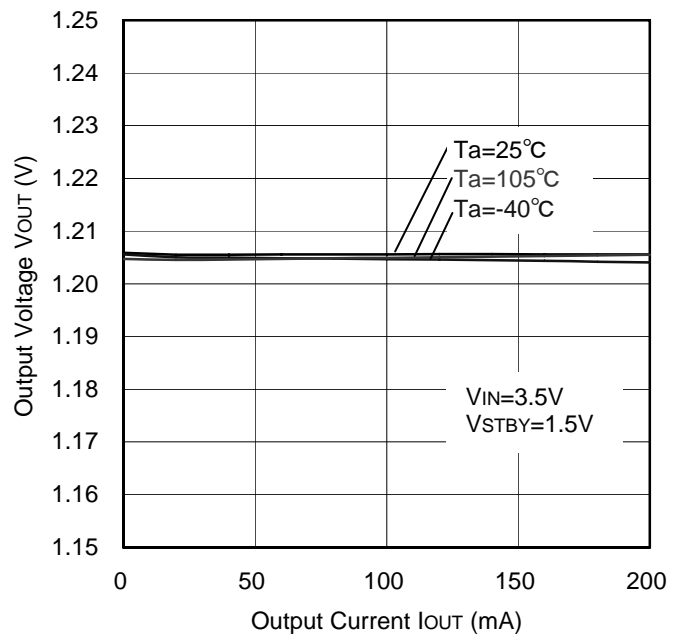

Figure 6. Load Regulation

●Reference data BU12SD2MG-M (Unless otherwise specified, $T_a=25^\circ\text{C}$.)

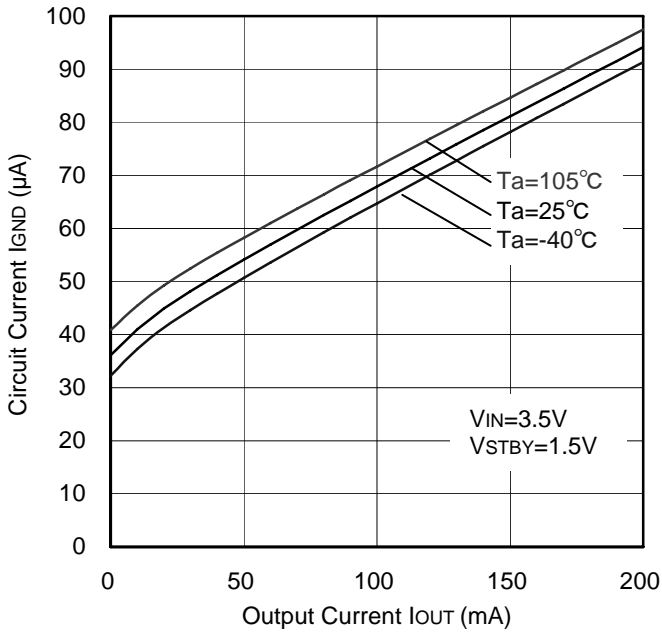

Figure 7. Circuit Current vs. Output Current

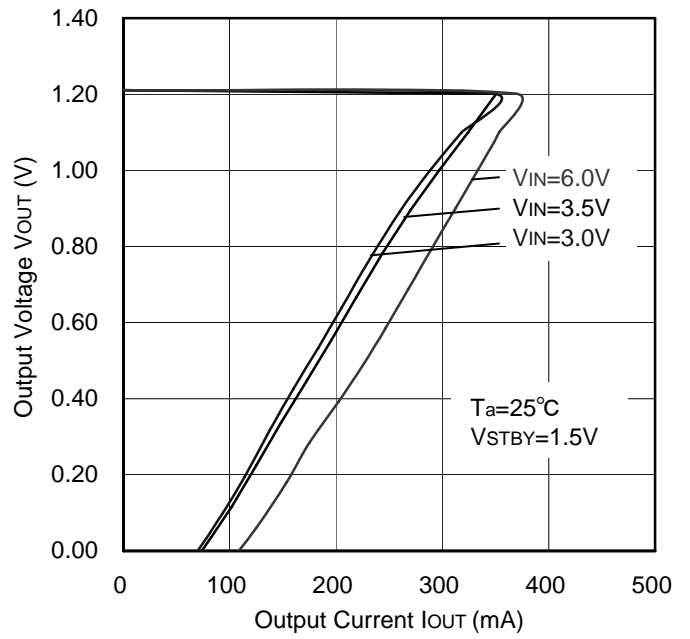

Figure 8. OCP Threshold

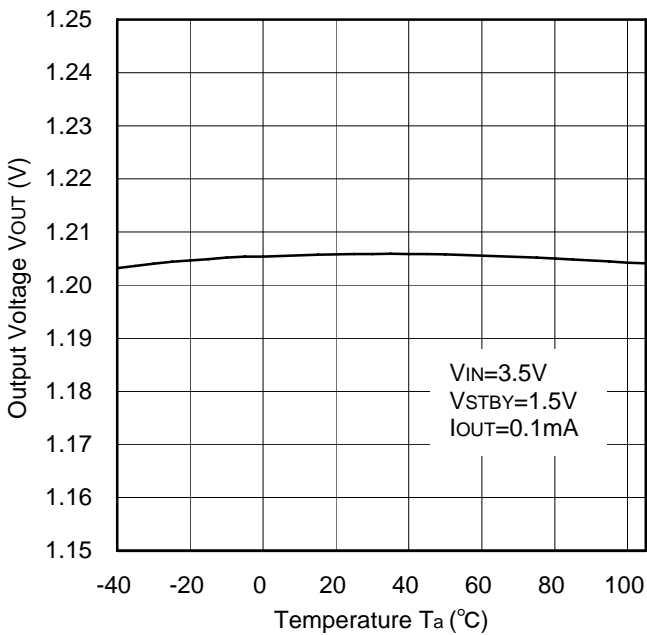

Figure 9. Output Voltage vs. Temperature

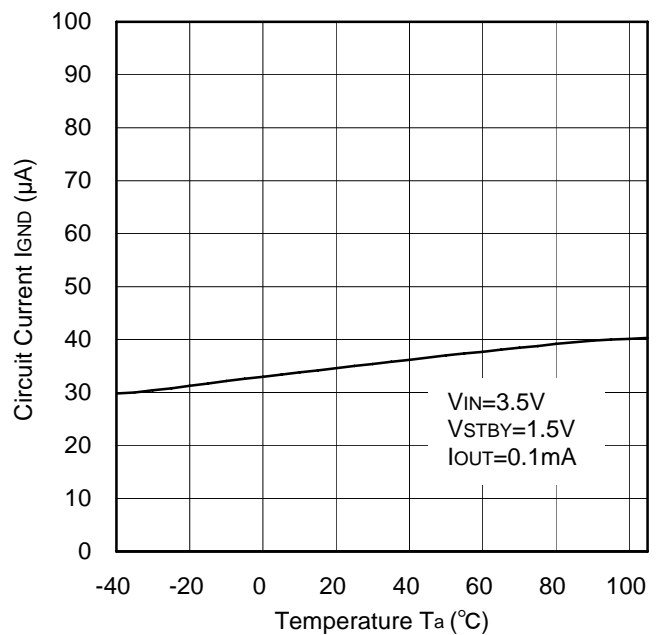

Figure 10. Circuit Current vs. Temperature

●Reference data BU12SD2MG-M (Unless otherwise specified, Ta=25°C.)

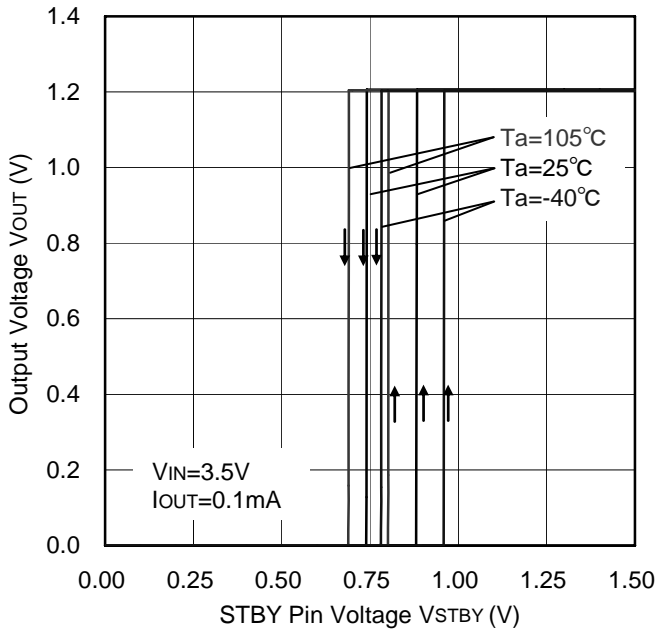

Figure 11. STBY Threshold

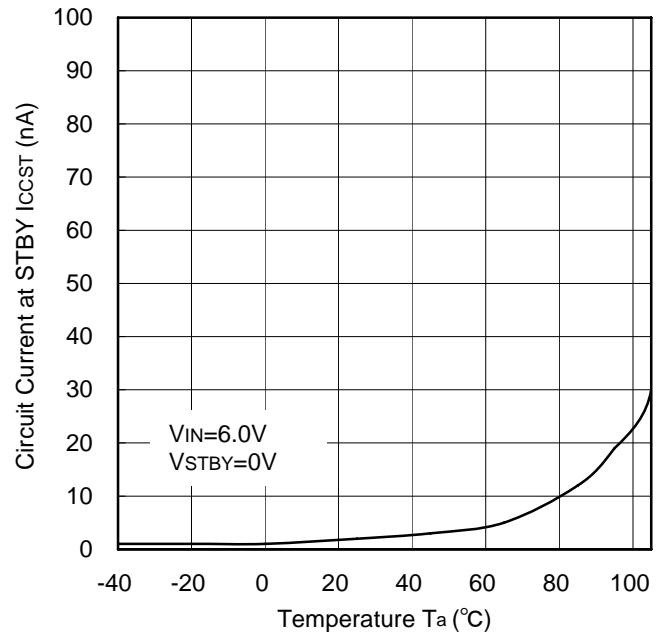

Figure 12. Circuit Current (at STBY) vs. Temperature

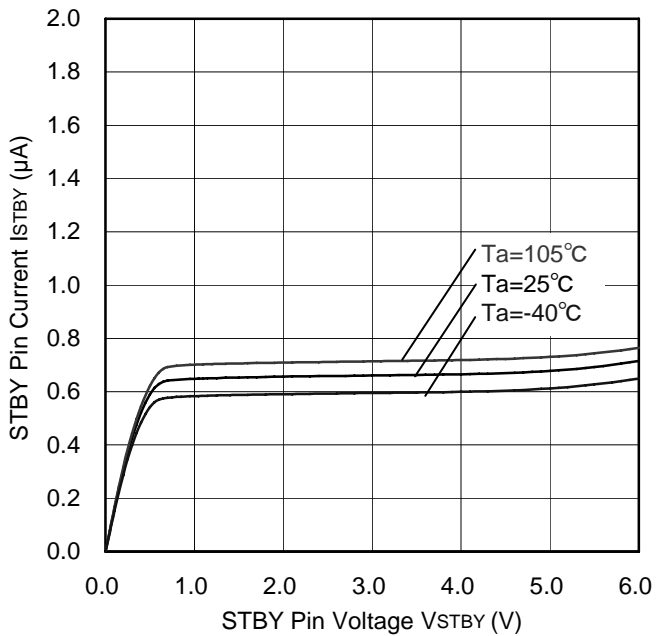

Figure 13. STBY Pin Current vs. STBY Pin Voltage

●Reference data BU12SD2MG-M (Unless otherwise specified, Ta=25°C.)

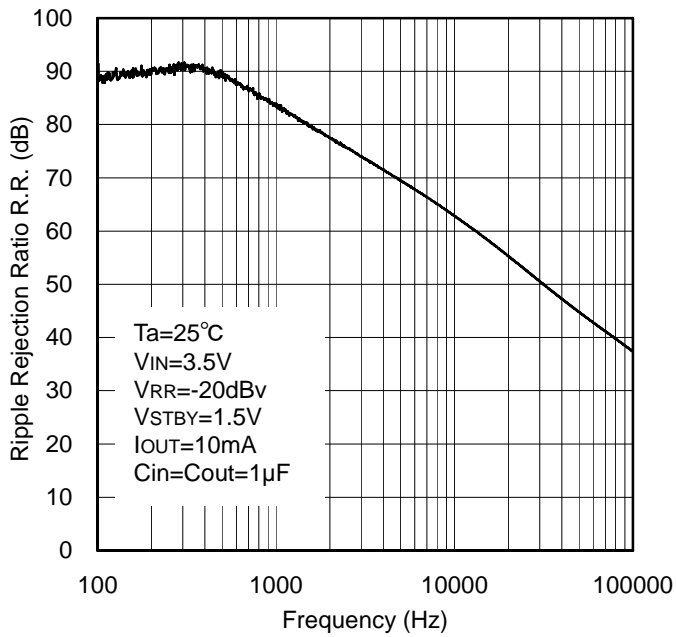

Figure 14. Ripple Rejection Ratio vs. Frequency

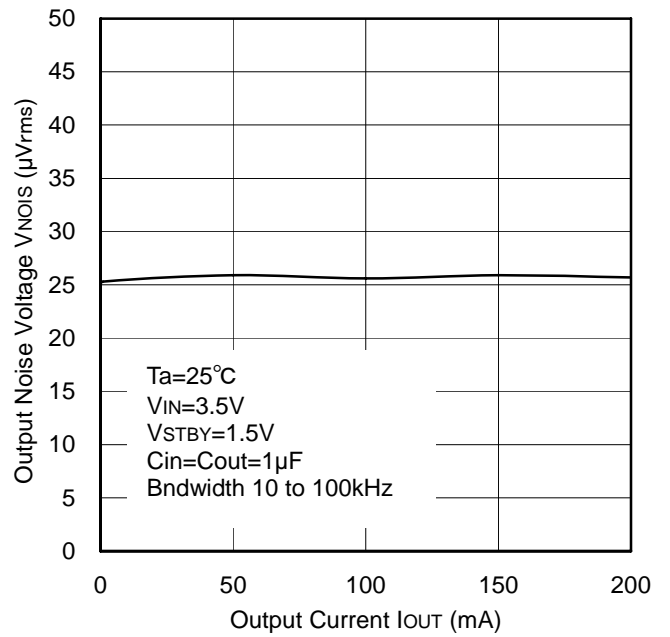

Figure 15. Output Noise Voltage vs. Output Current

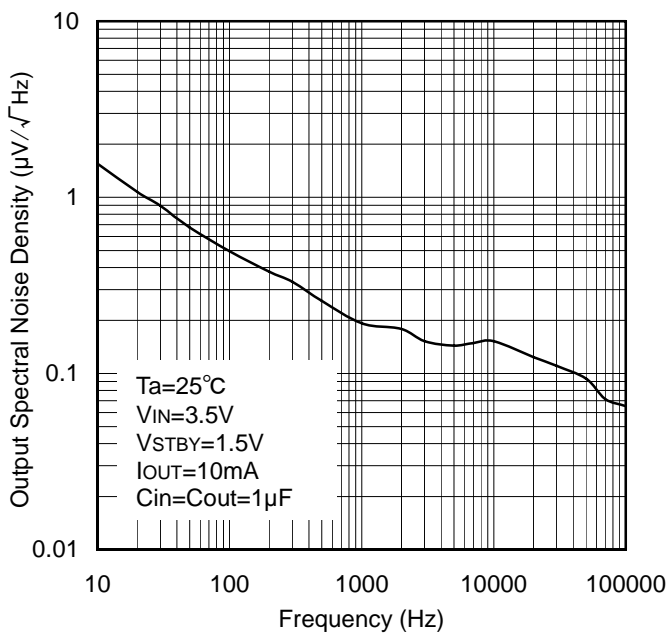

Figure 16. Output Spectral Noise Density vs. Frequency

●Reference data BU12SD2MG-M (Unless otherwise specified, Ta=25°C.)

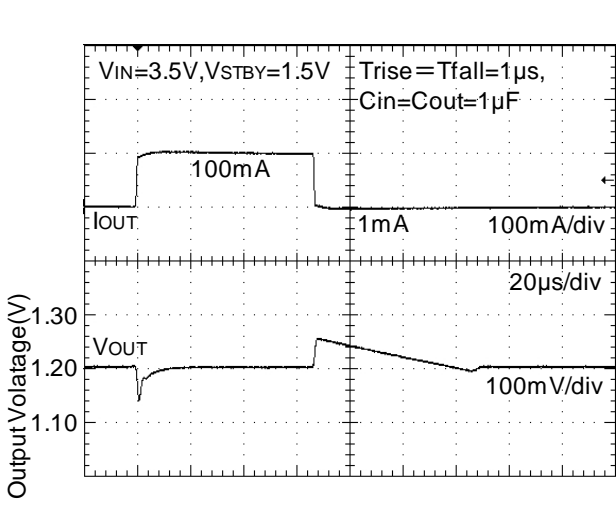

Figure 17. Load Response (1mA to 100mA)

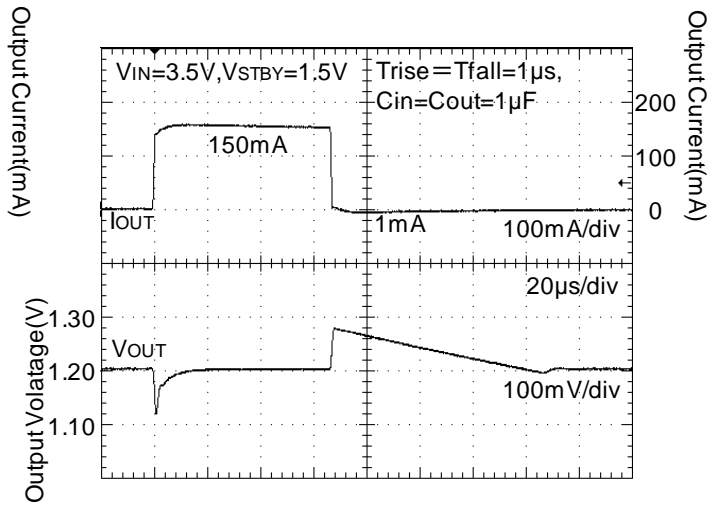

Figure 18. Load Response (1mA to 150mA)

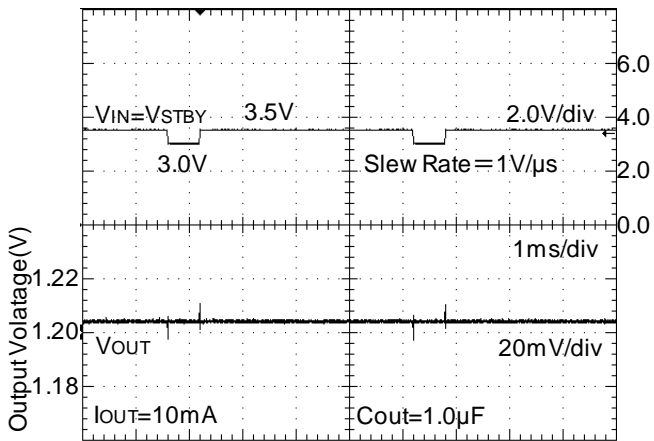

Figure 19. Line Transient Response (3.0 to 3.5V)

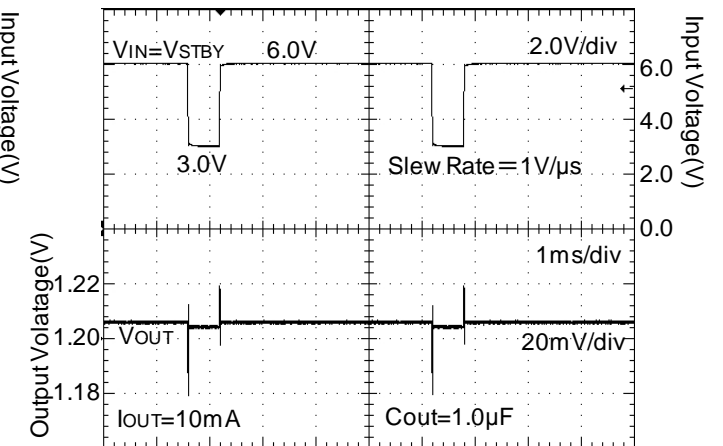

Figure 20. Line Transient Response (3.0 to 6.0V)

●Reference data BU12SD2MG-M (Unless otherwise specified, Ta=25°C.)

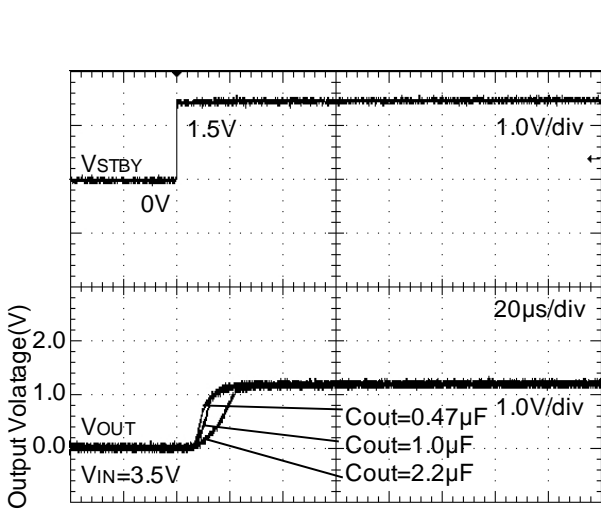

Figure 21. Startup Time (ROUT=none)

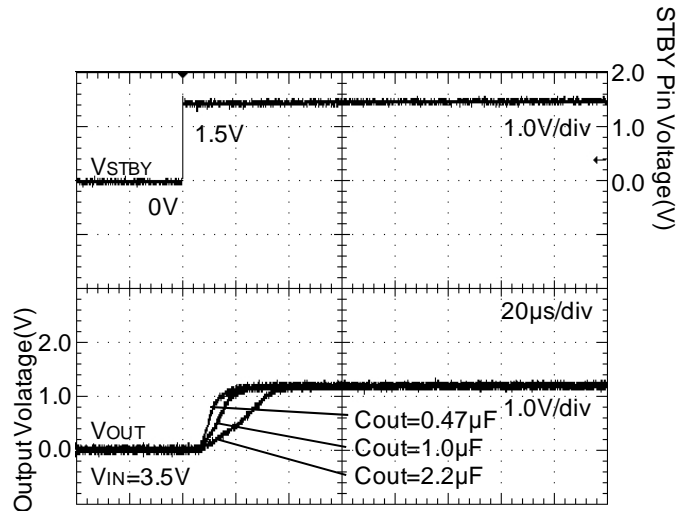

Figure 22. Startup Time (ROUT=6Ω)

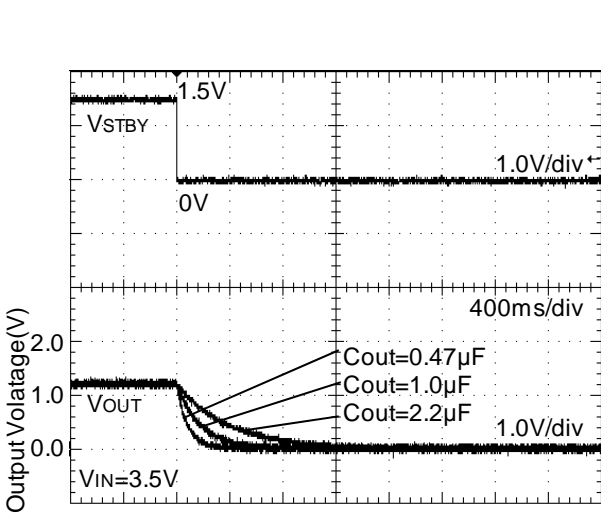

Figure 23. Discharge Time (ROUT=none)

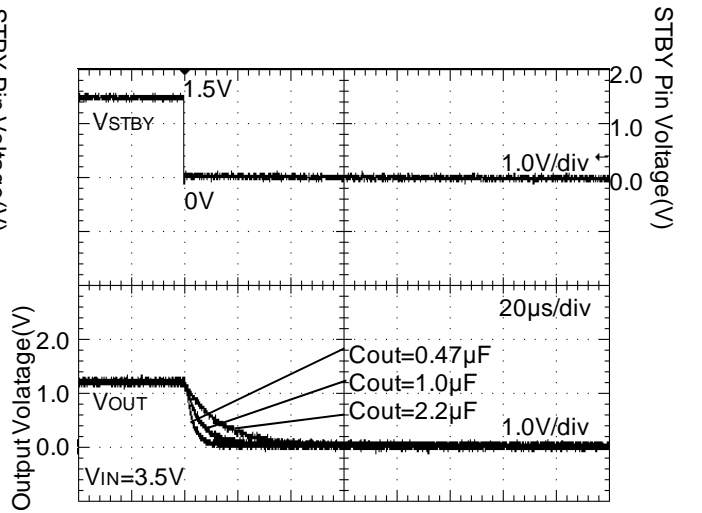

Figure 24. Discharge Time (ROUT=6Ω)

●Reference data BU18SD2MG-M (Unless otherwise specified, $T_a=25^\circ\text{C}$.)

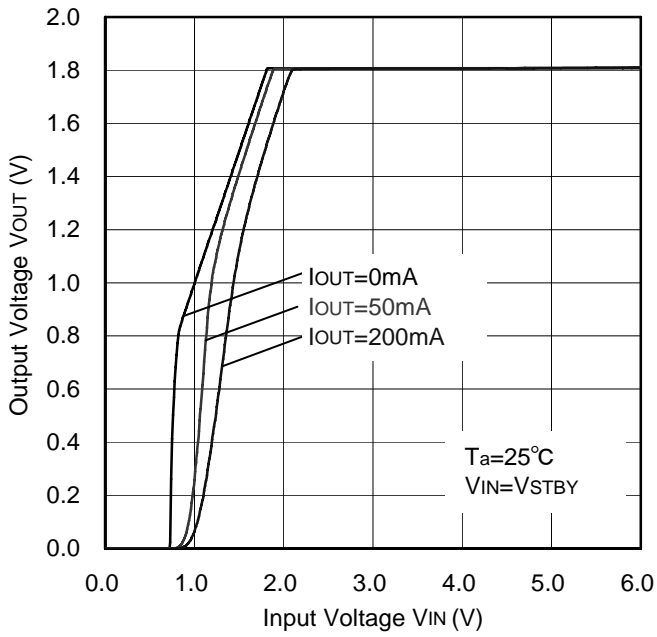

Figure 25. Output Voltage vs. Input Voltage

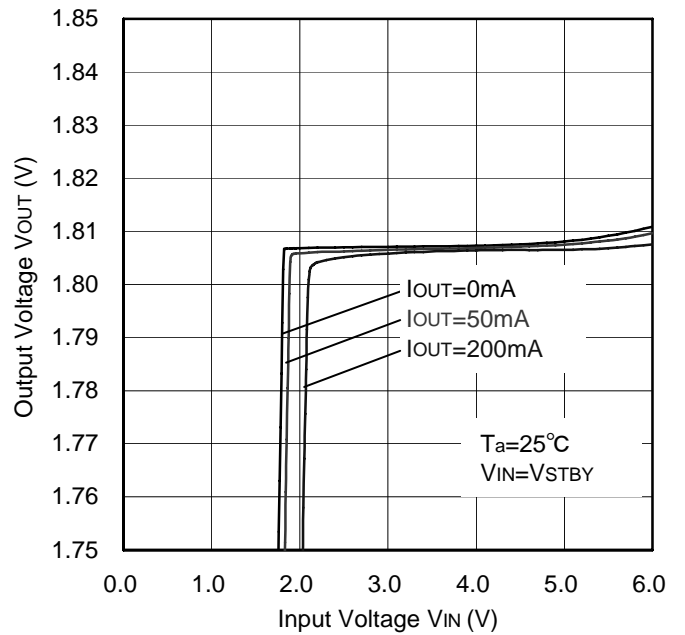

Figure 26. Line Regulation

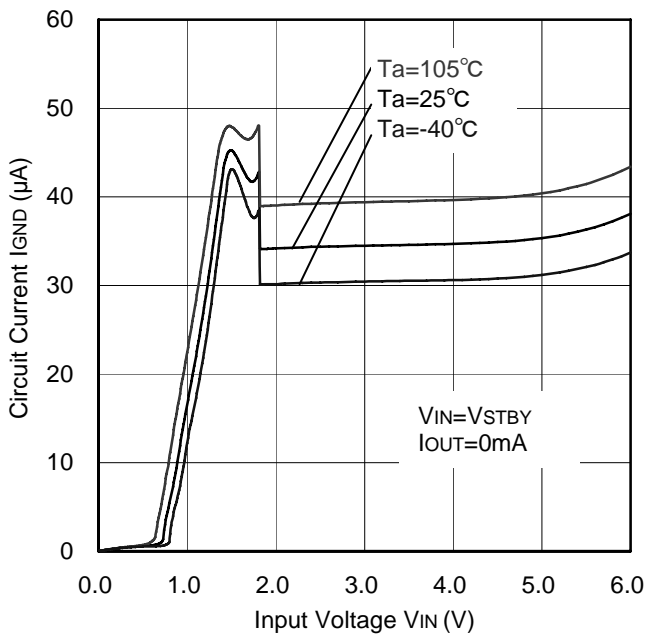

Figure 27. Circuit Current vs. Input Voltage

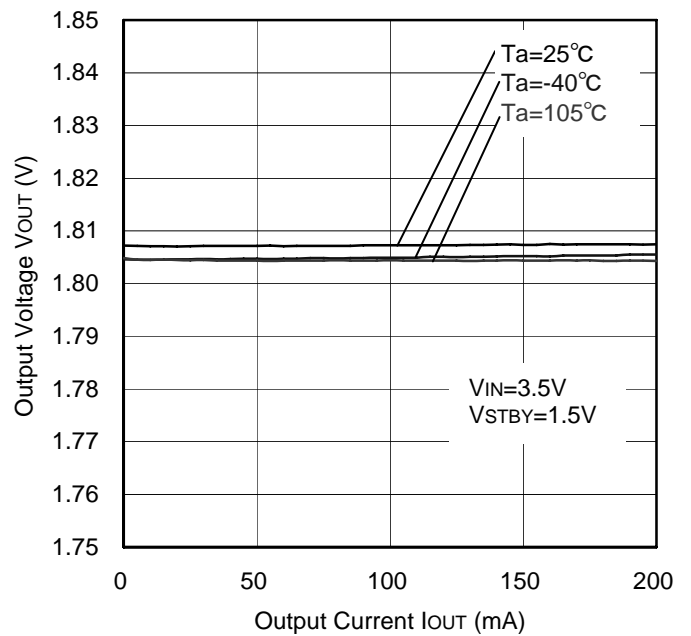

Figure 28. Load Regulation

●Reference data BU18SD2MG-M (Unless otherwise specified, $T_a=25^\circ\text{C}$.)

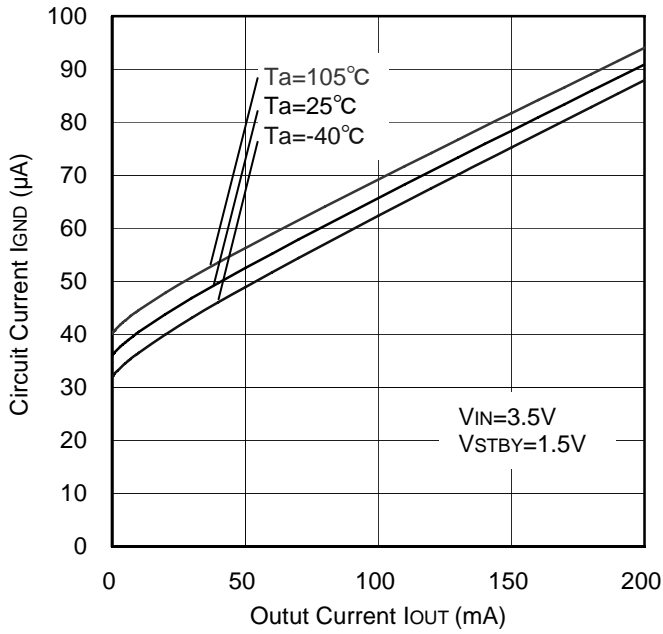

Figure 29. Circuit Current vs. Output Current

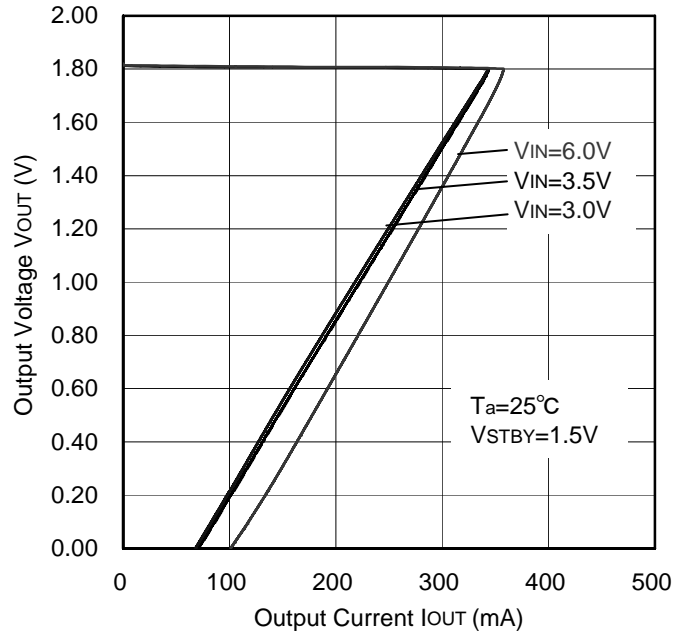

Figure 30. OCP Threshold

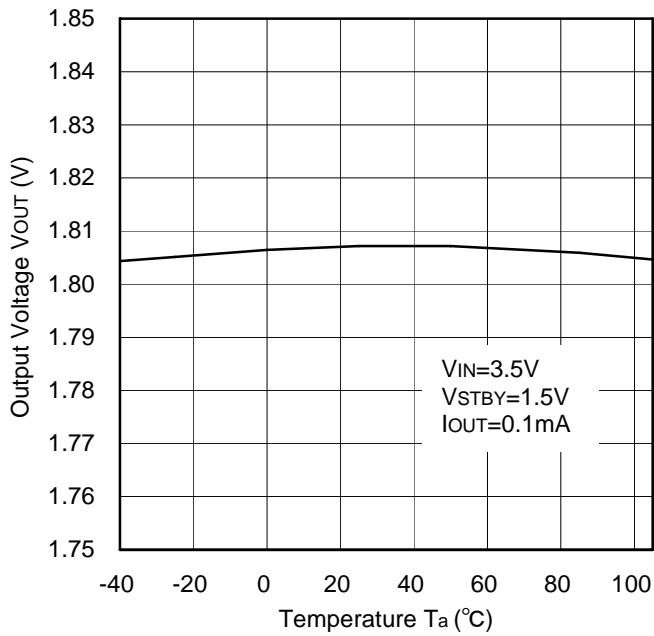

Figure 31. Output Voltage vs. Temperature

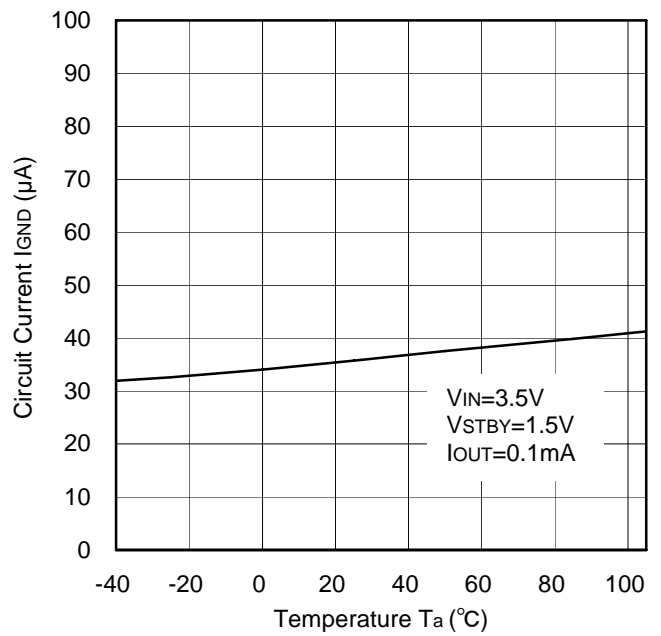

Figure 32. Circuit Current vs. Temperature

●Reference data BU18SD2MG-M (Unless otherwise specified, Ta=25°C.)

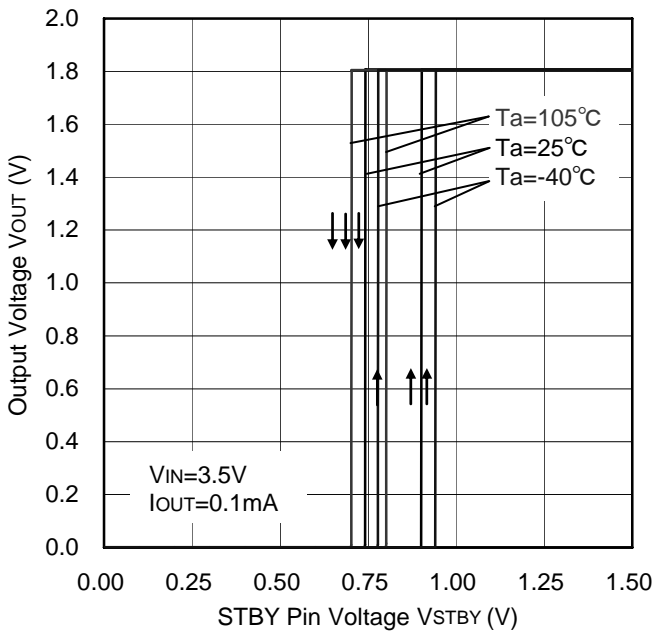

Figure 33. STBY Threshold

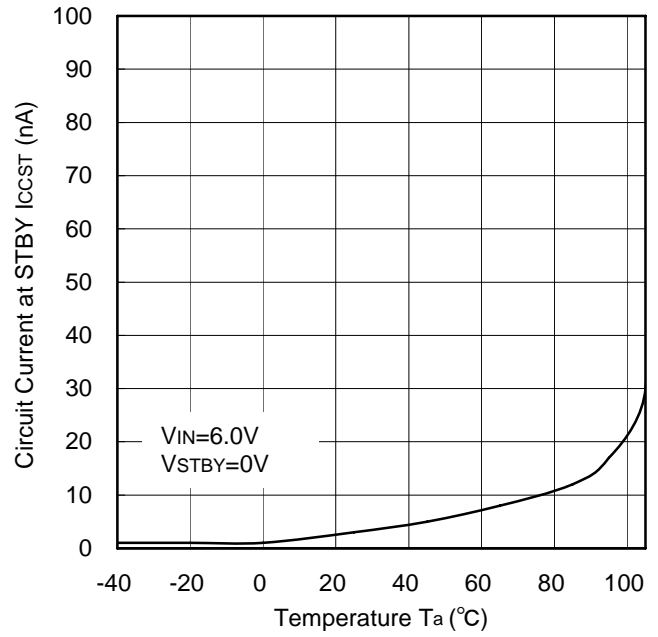

Figure 34. Circuit Current (at STBY) vs. Temperature

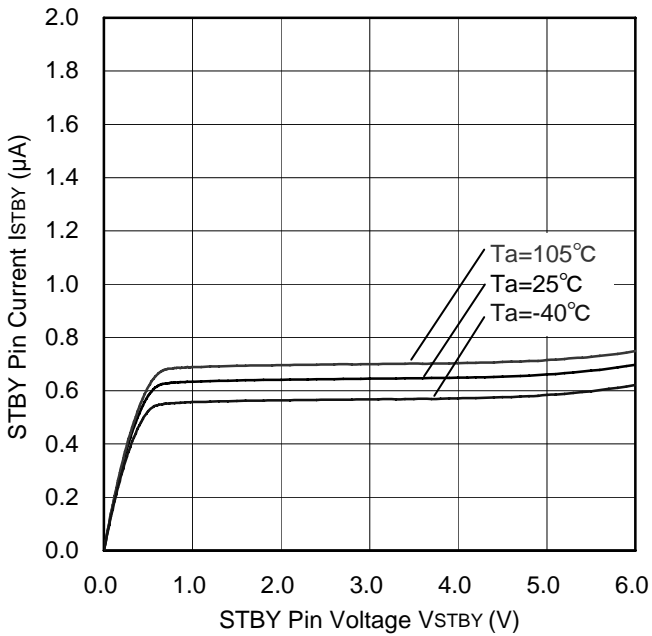

Figure 35. STBY Pin Current vs. STBY Pin Voltage

●Reference data BU18SD2MG-M (Unless otherwise specified, Ta=25°C.)

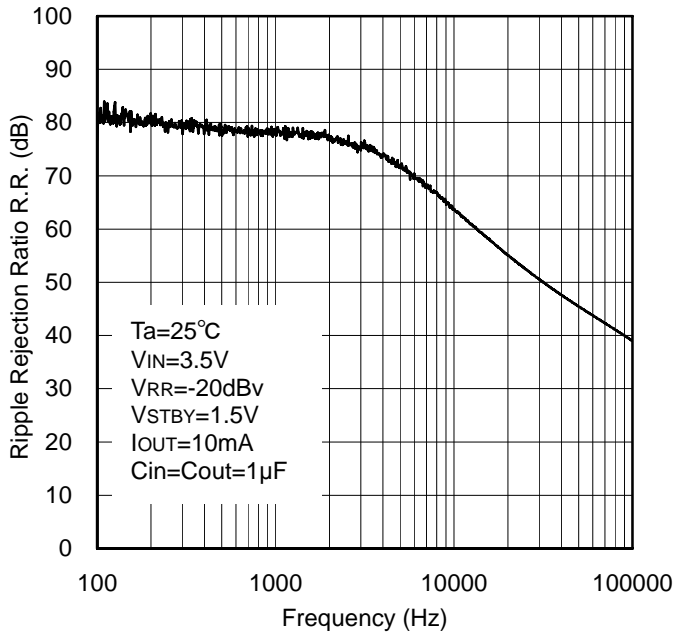

Figure 36. Ripple Rejection Ratio vs. Frequency

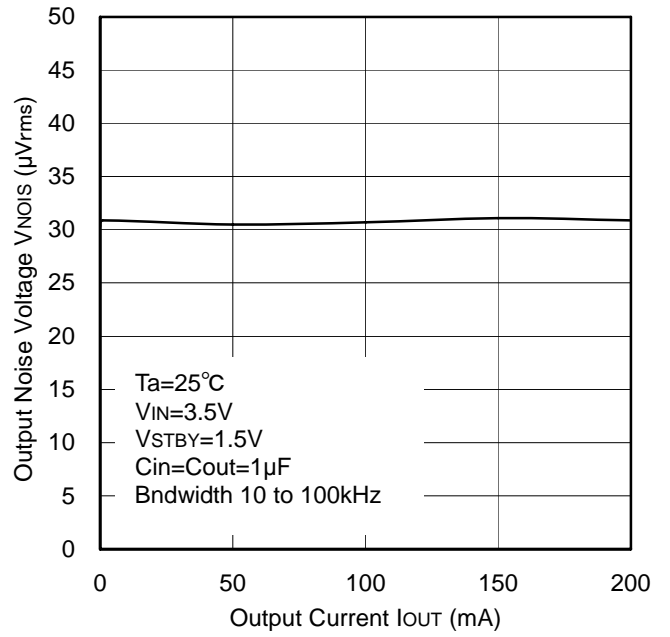

Figure 37. Output Noise Voltage vs. Output Current

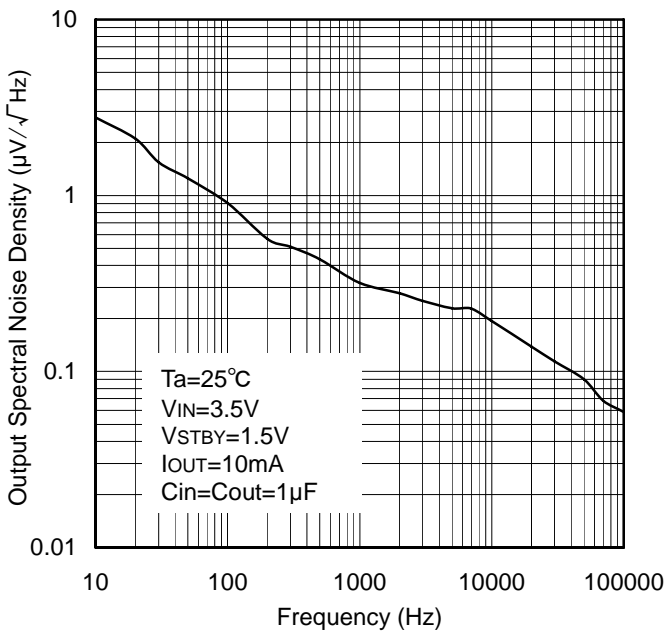

Figure 38. Output Spectral Noise Density vs. Frequency

●Reference data BU18SD2MG-M (Unless otherwise specified, Ta=25°C.)

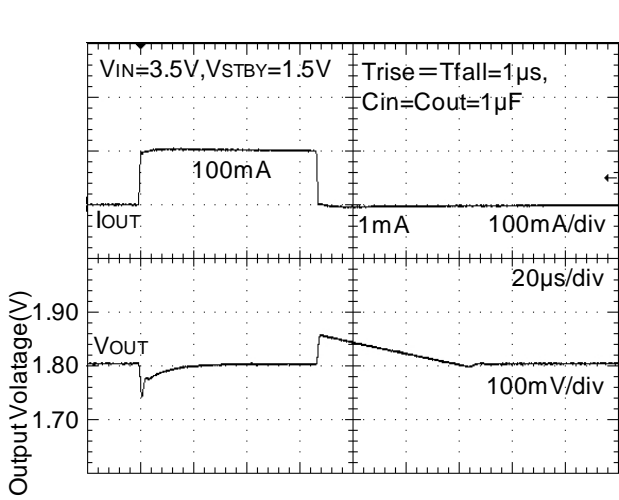

Figure 39. Load Response (1mA to 100mA)

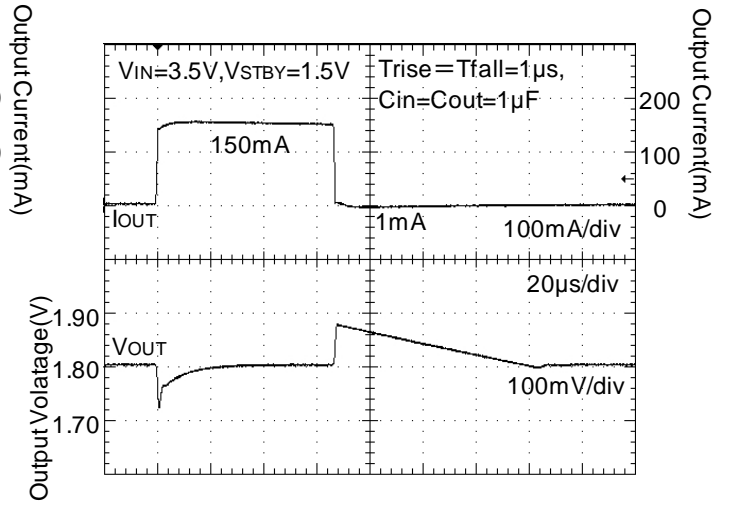

Figure 40. Load Response (1mA to 150mA)

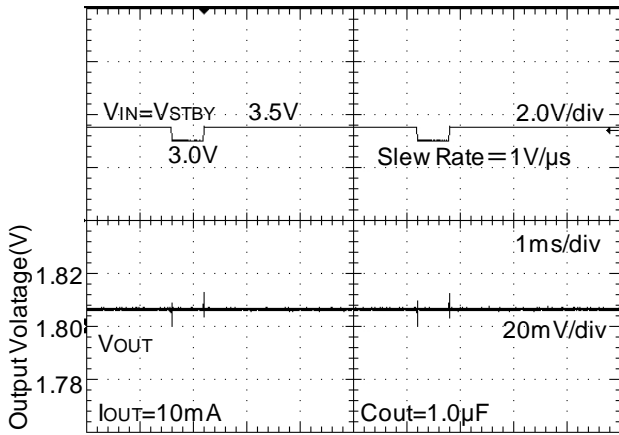

Figure 41. Line Transient Response (3.0 to 3.5V)

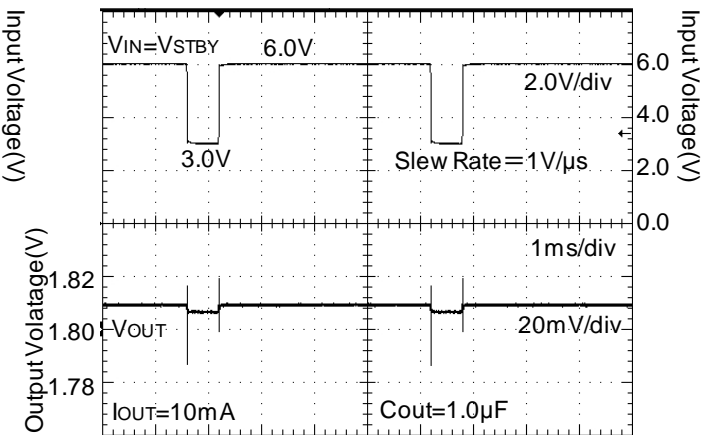

Figure 42. Line Transient Response (3.0 to 6.0V)

●Reference data BU18SD2MG-M (Unless otherwise specified, Ta=25°C.)

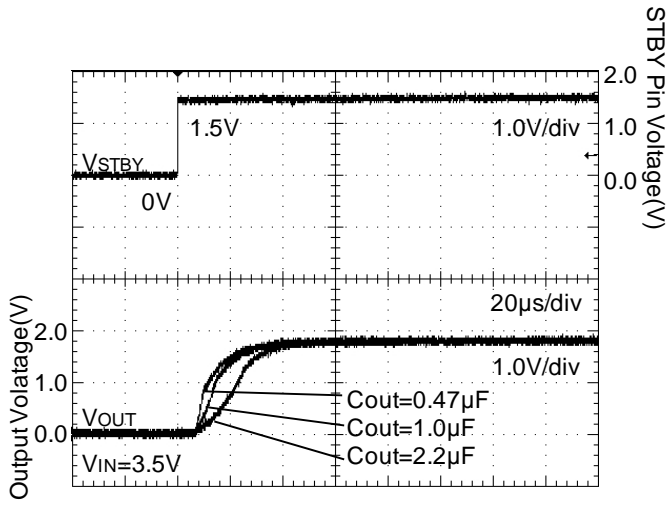

Figure 43. Startup Time (ROUT=none)

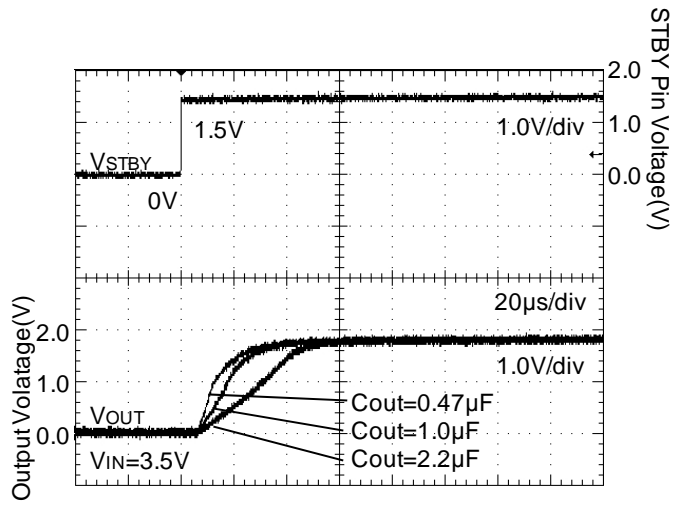

Figure 44. Startup Time (ROUT=9Ω)

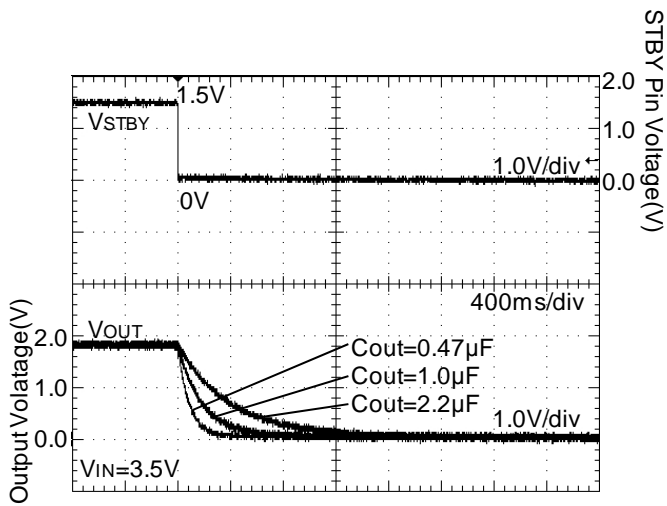

Figure 45. Discharge Time (ROUT=none)

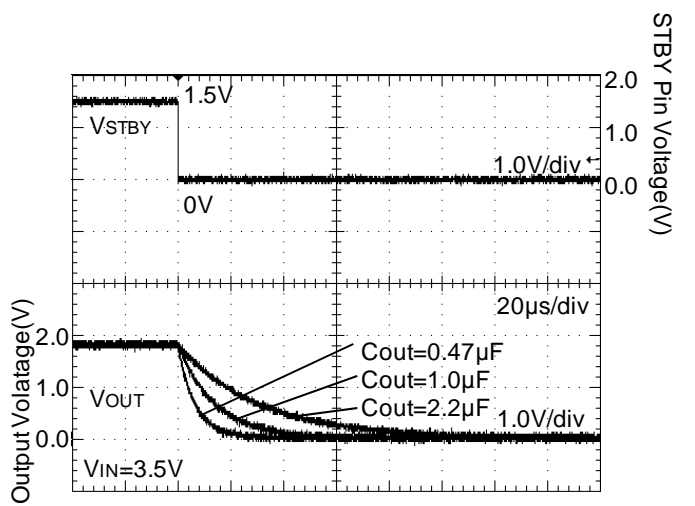

Figure 46. Discharge Time (ROUT=9Ω)

●Reference data BU25SD2MG-M (Unless otherwise specified, $T_a=25^\circ\text{C}$.)

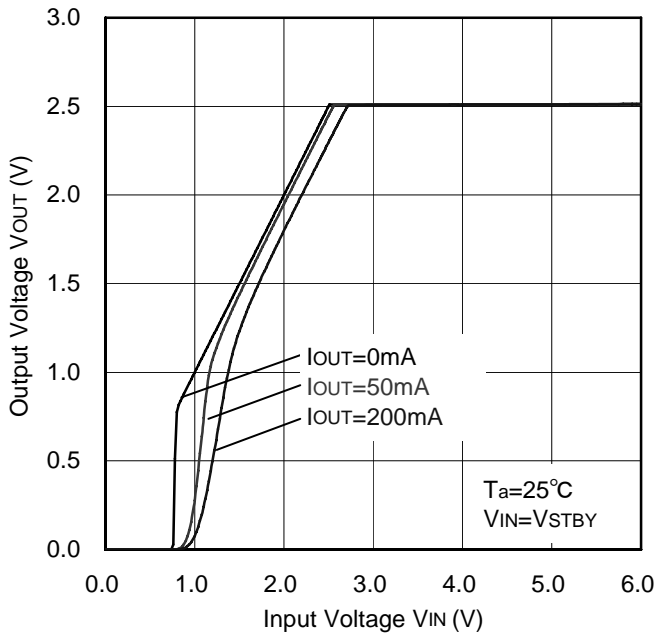

Figure 47. Output Voltage vs. Input Voltage

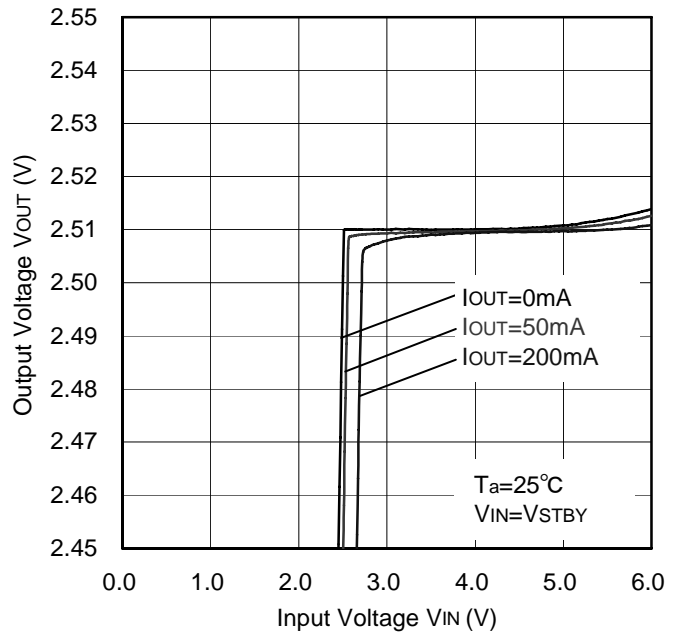

Figure 48. Line Regulation

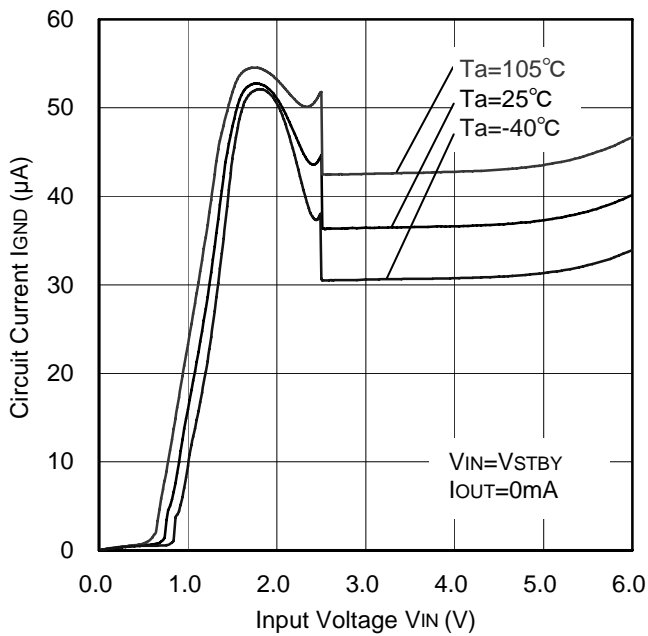

Figure 49. Circuit Current vs. Input Voltage

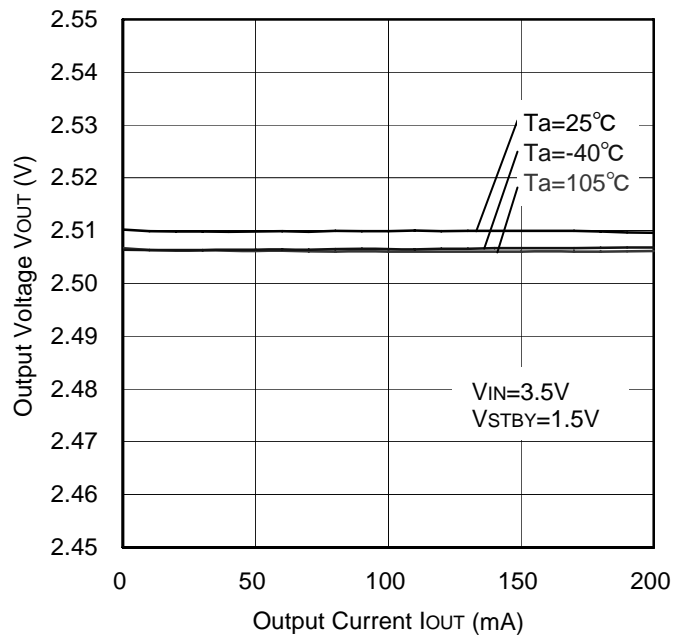

Figure 50. Load Regulation

●Reference data BU25SD2MG-M (Unless otherwise specified, $T_a=25^\circ\text{C}$.)

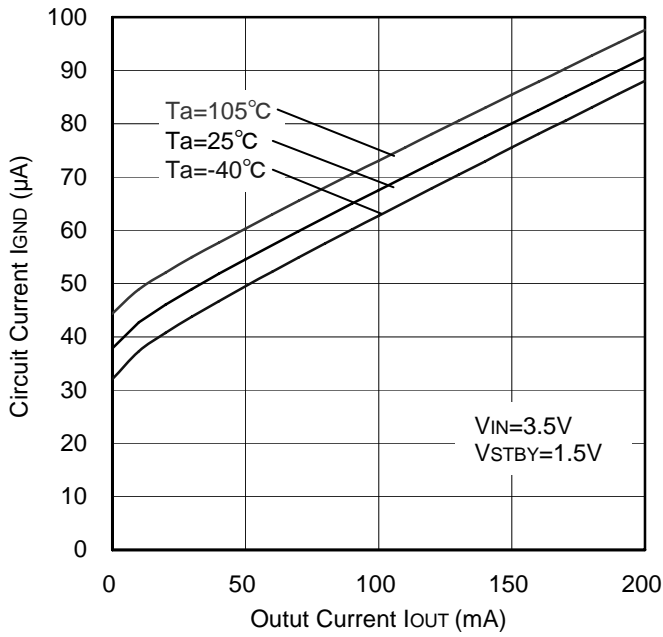

Figure 51. Circuit Current vs. Output Current

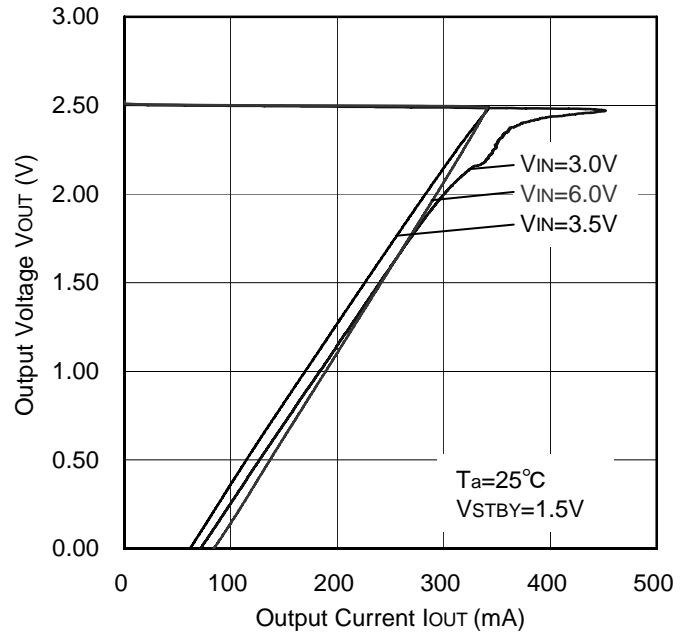

Figure 52. OCP Threshold

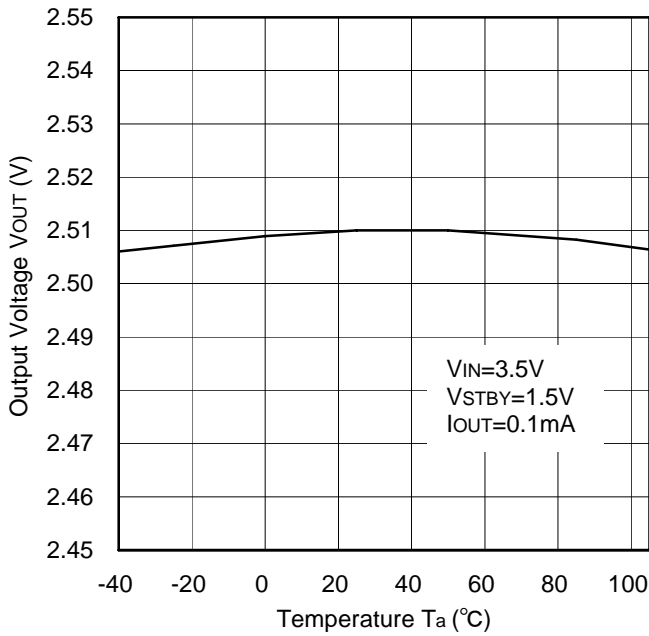

Figure 53. Output Voltage vs. Temperature

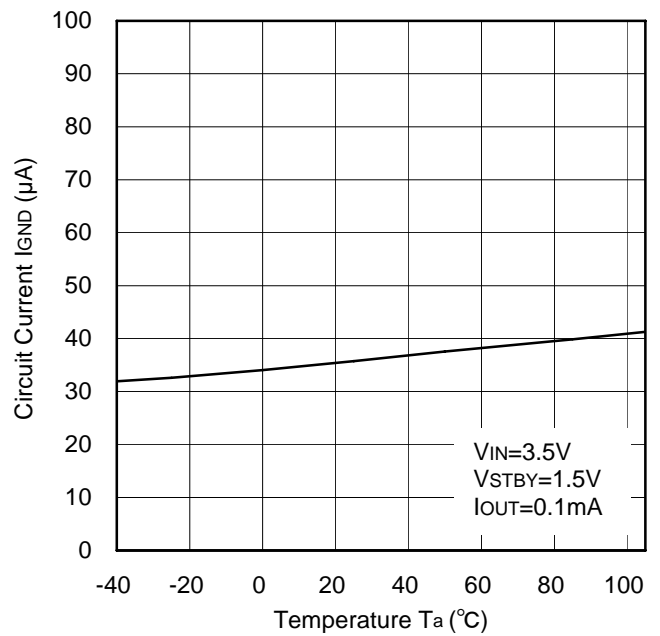

Figure 54. Circuit Current vs. Temperature

●Reference data BU25SD2MG-M (Unless otherwise specified, Ta=25°C.)

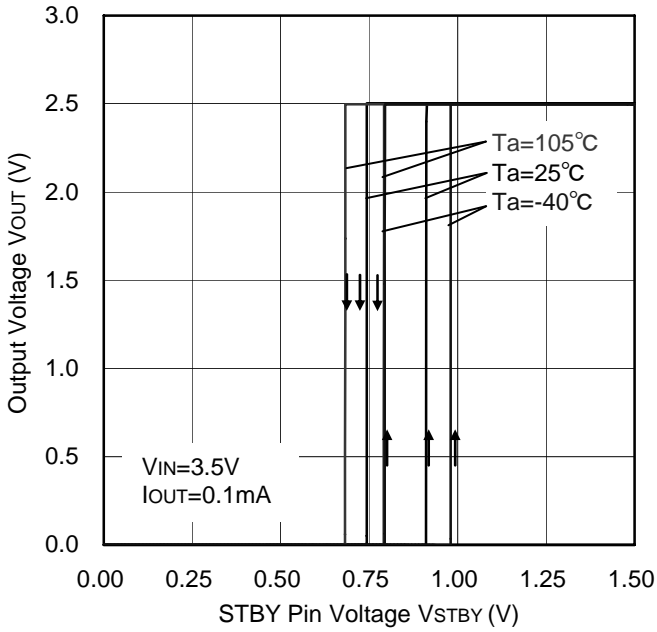

Figure 55. STBY Threshold

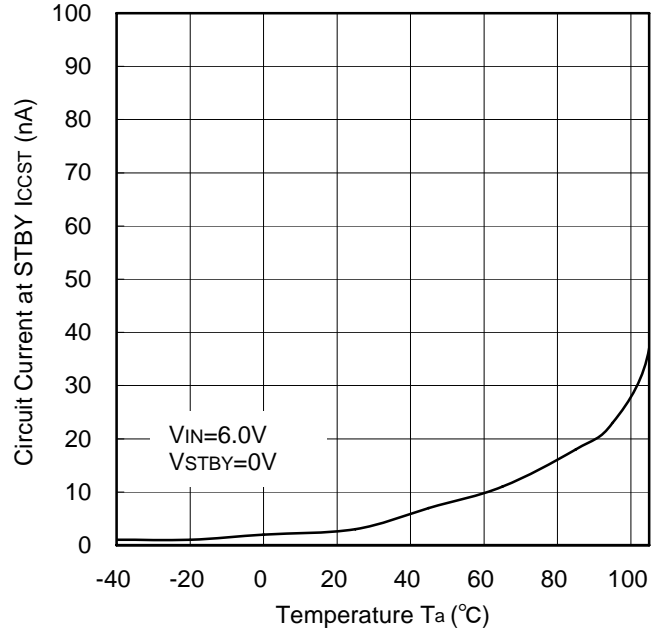

Figure 56. Circuit Current (at STBY) vs. Temperature

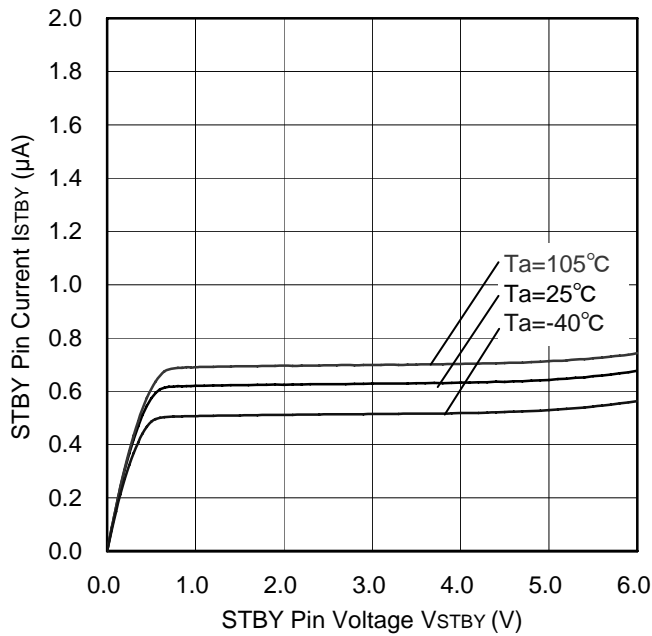

Figure 57. STBY Pin Current vs. STBY Pin Voltage

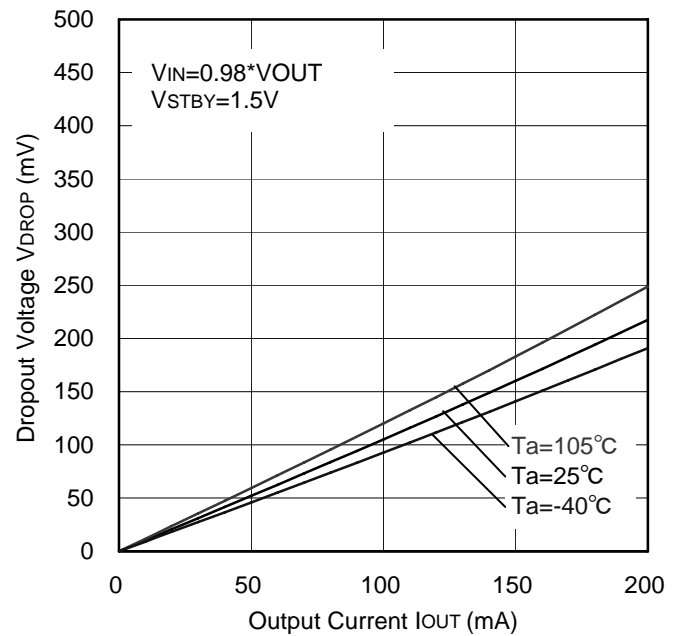

Figure 58. Dropout Voltage vs. Output Current

●Reference data BU25SD2MG-M (Unless otherwise specified, Ta=25°C.)

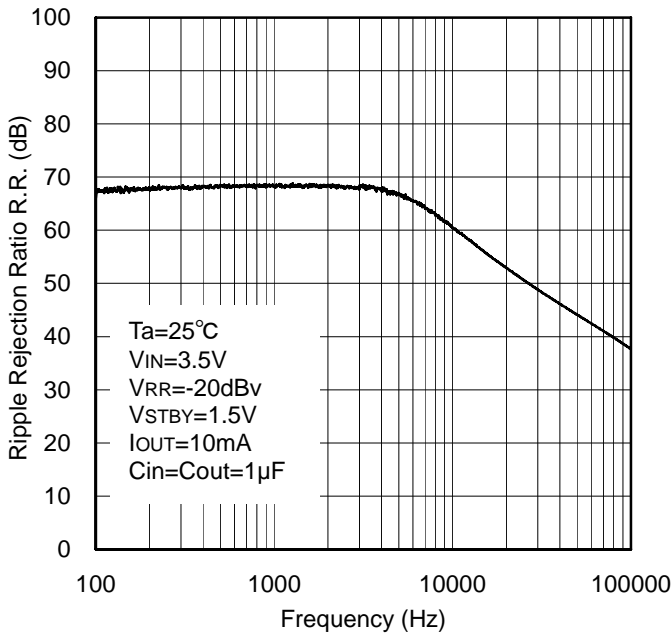

Figure 59. Ripple Rejection Ratio vs. Frequency

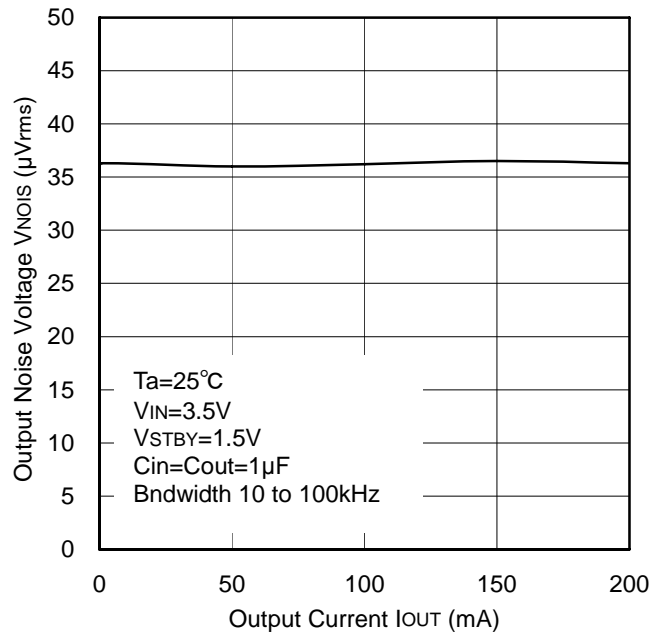

Figure 60. Output Noise Voltage vs. Output Current

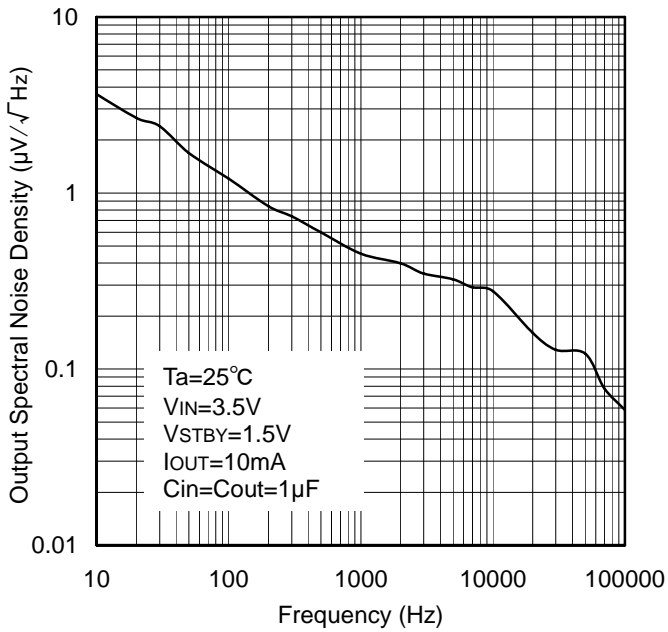

Figure 61. Output Spectral Noise Density vs. Frequency

●Reference data BU25SD2MG-M (Unless otherwise specified, Ta=25°C.)

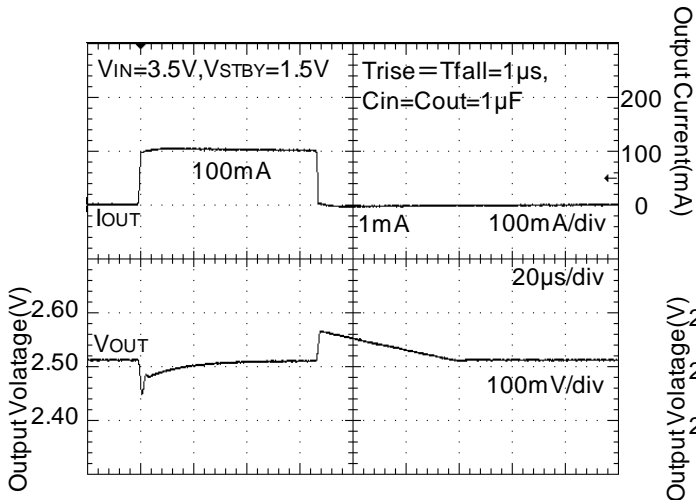

Figure 62. Load Response (1mA to 100mA)

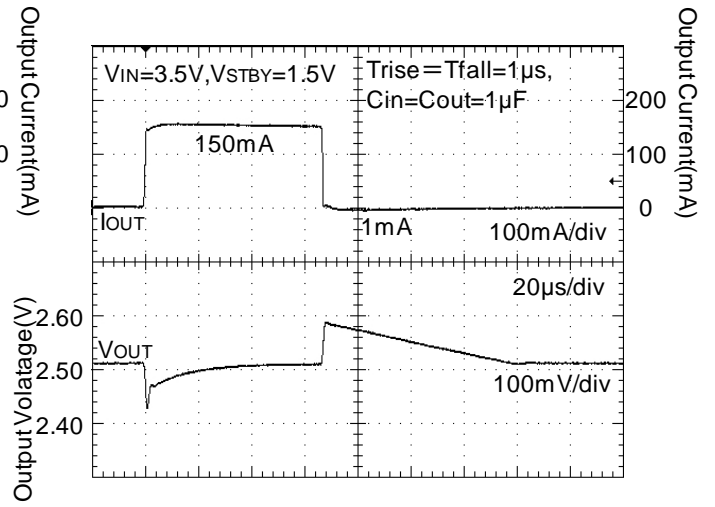

Figure 63. Load Response (1mA to 150mA)

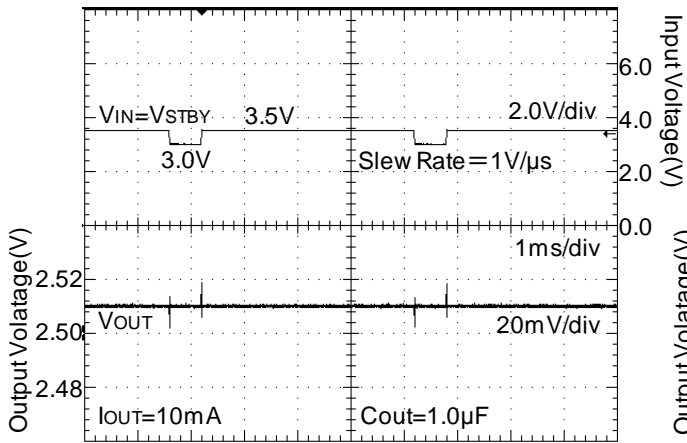

Figure 64. Line Transient Response (3.0 to 3.5V)

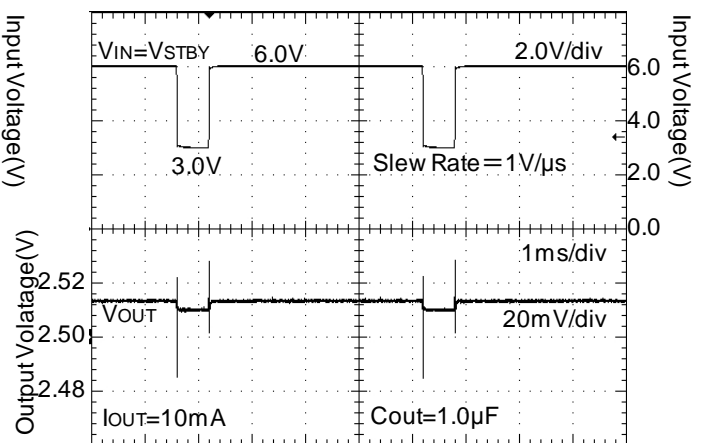

Figure 65. Line Transient Response (3.0 to 6.0V)

●Reference data BU25SD2MG-M (Unless otherwise specified, Ta=25°C.)

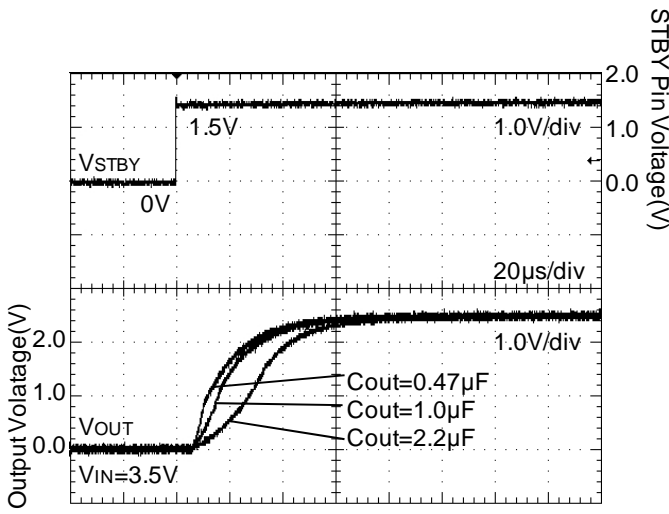

Figure 66. Startup Time (ROUT=none)

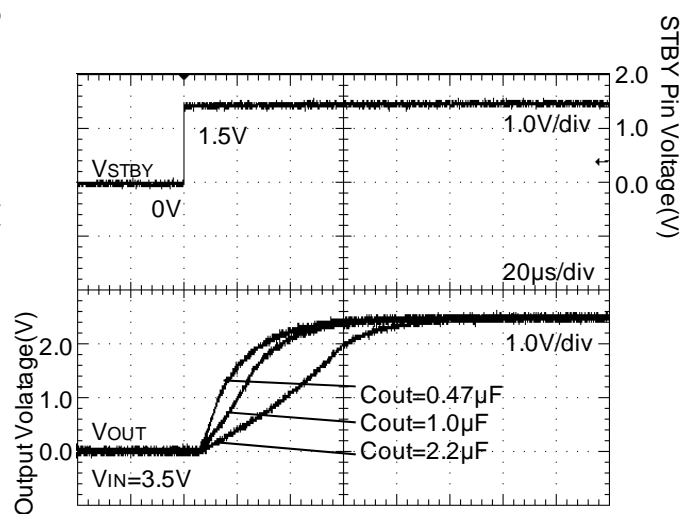

Figure 67. Startup Time (ROUT=12.5Ω)

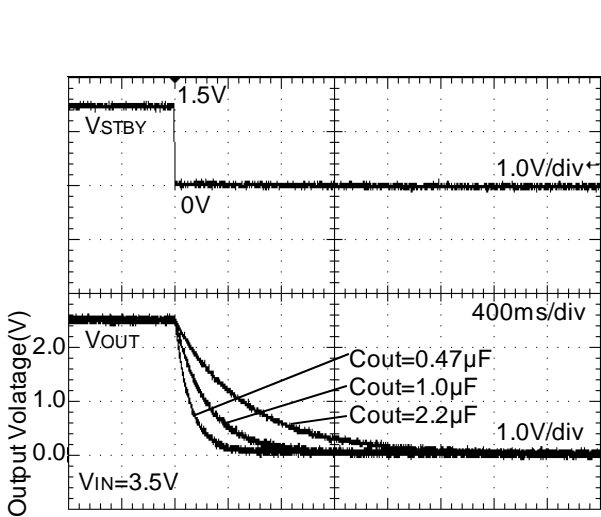

Figure 68. Discharge Time (ROUT=none)

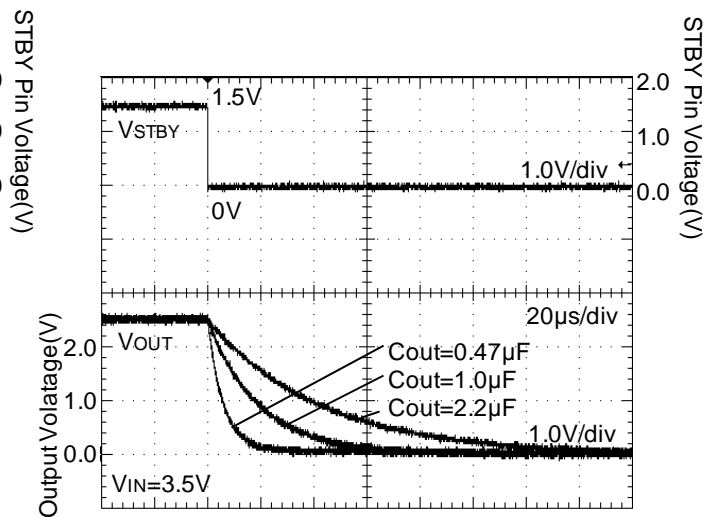

Figure 69. Discharge Time (ROUT=12.5Ω)

●Reference data BU33SD2MG-M (Unless otherwise specified, $T_a=25^\circ\text{C}$.)

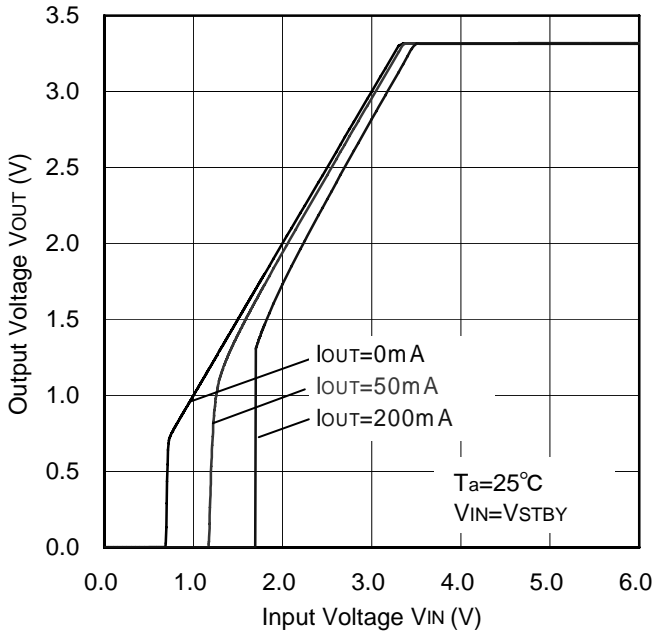

Figure 70. Output Voltage vs. Input Voltage

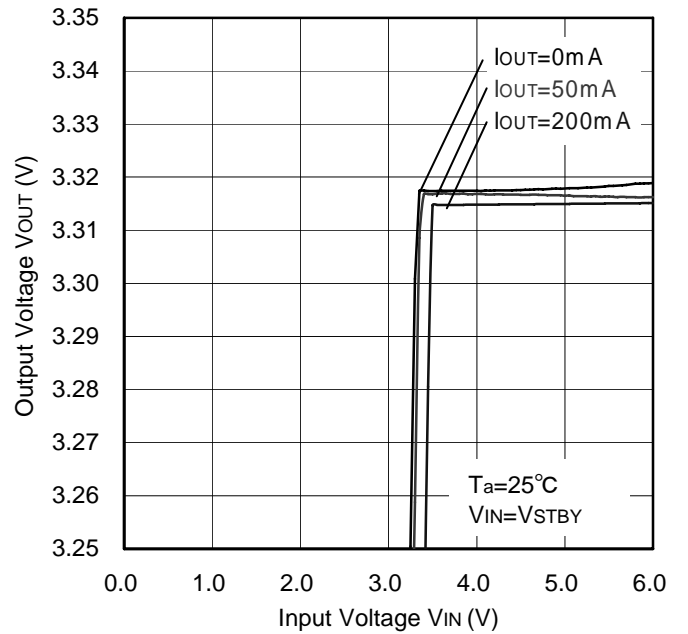

Figure 71. Line Regulation

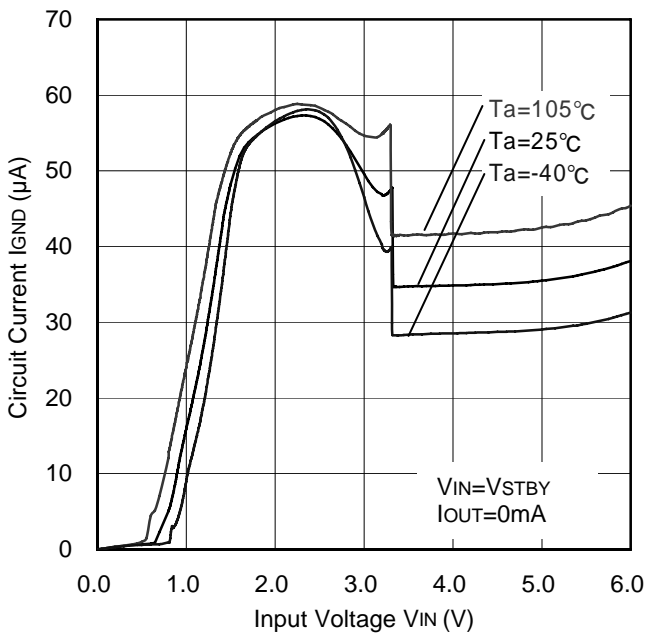

Figure 72. Circuit Current vs. Input Voltage

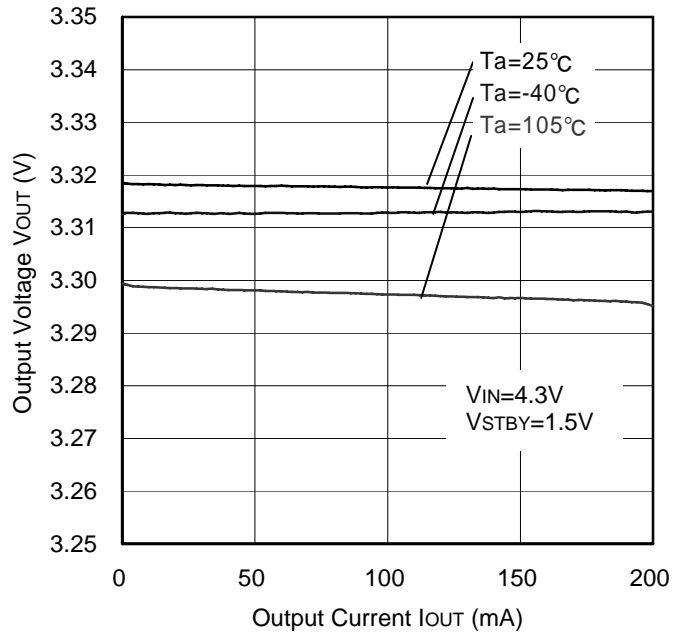

Figure 73. Load Regulation

●Reference data BU33SD2MG-M (Unless otherwise specified, Ta=25°C.)

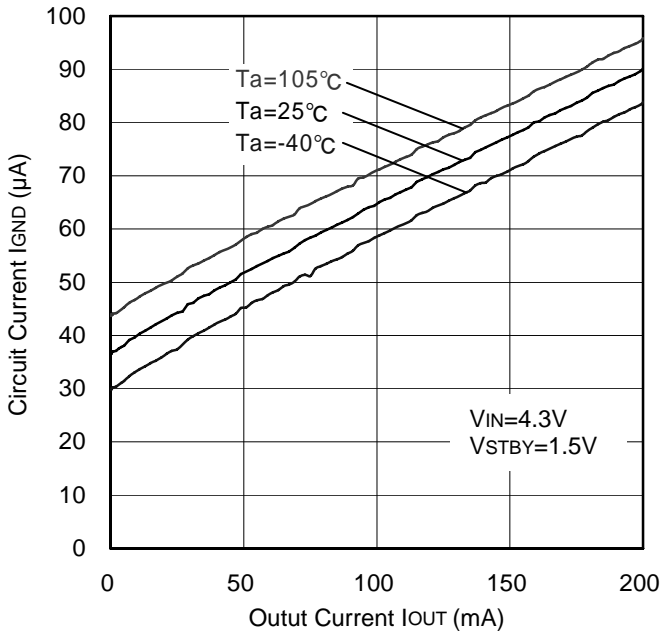

Figure 74. Circuit Current vs. Output Current

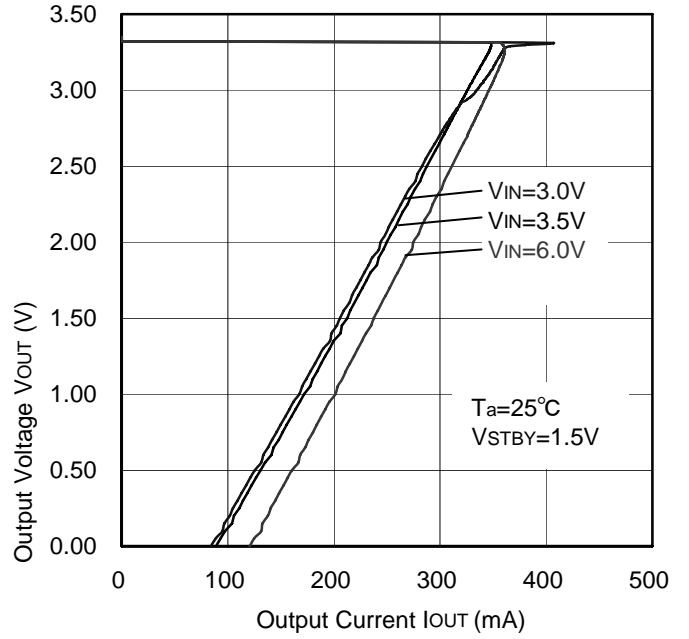

Figure 75. OCP Threshold

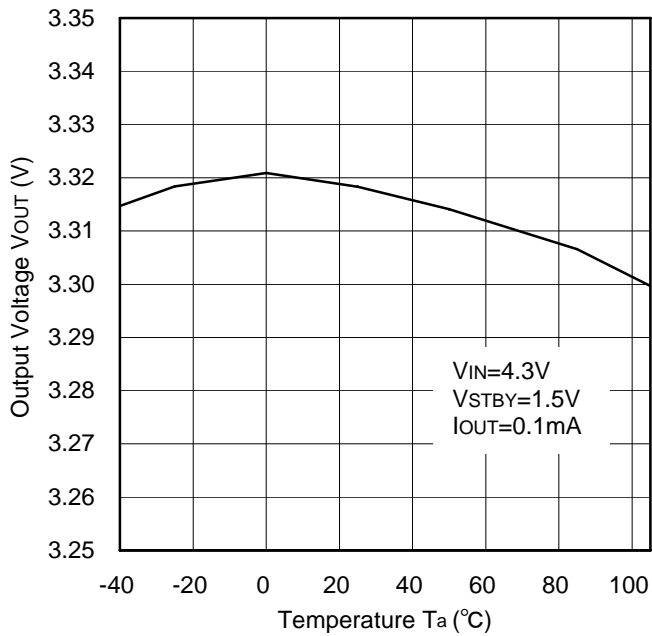

Figure 76. Output Voltage vs. Temperature

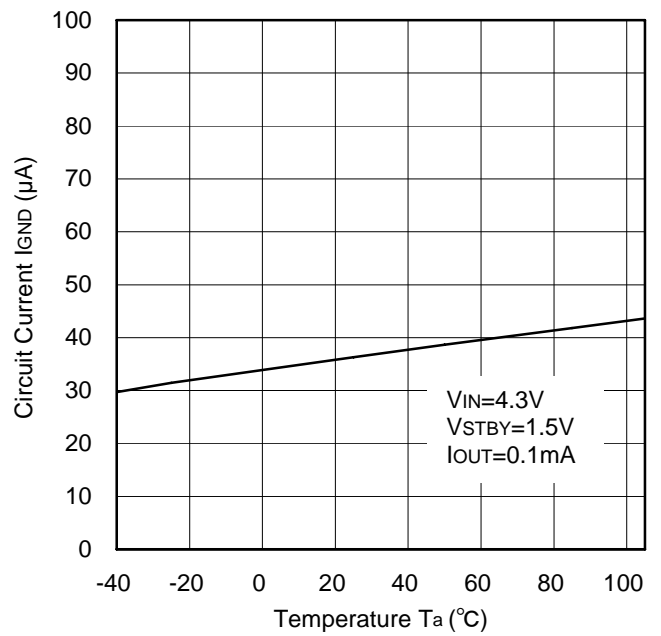

Figure 77. Circuit Current vs. Temperature

●Reference data BU33SD2MG-M (Unless otherwise specified, $T_a=25^\circ\text{C}$.)

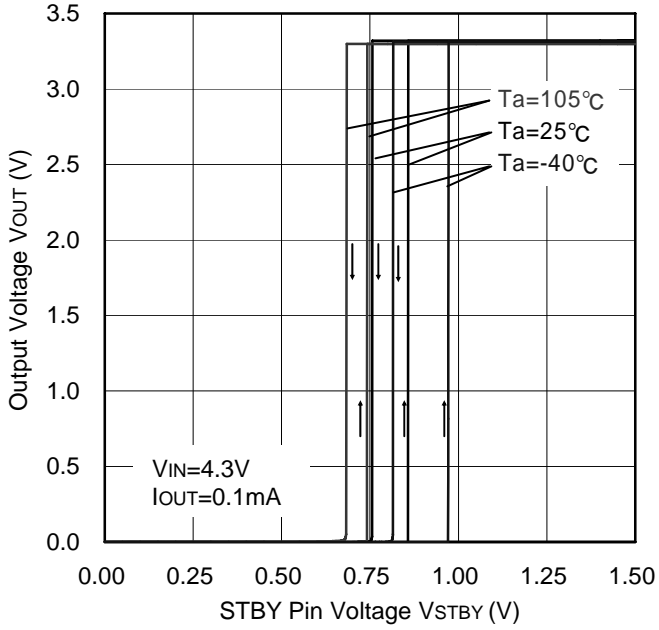

Figure 78. STBY Threshold

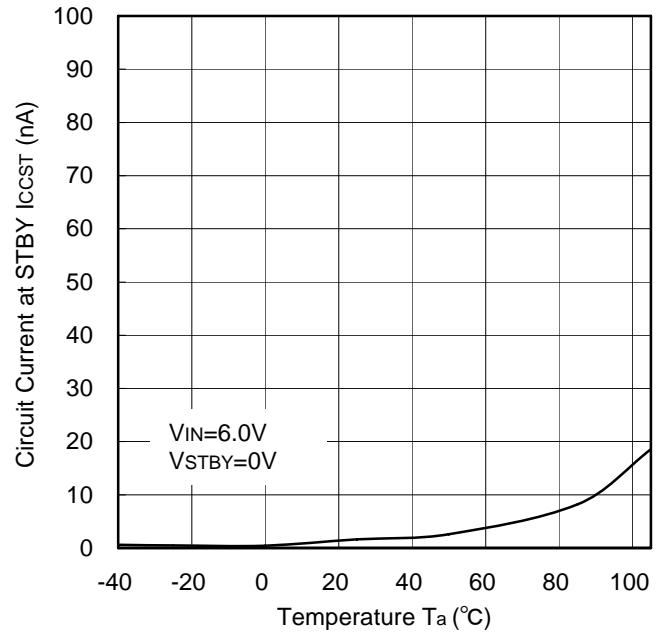

Figure 79. Circuit Current (at STBY) vs. Temperature

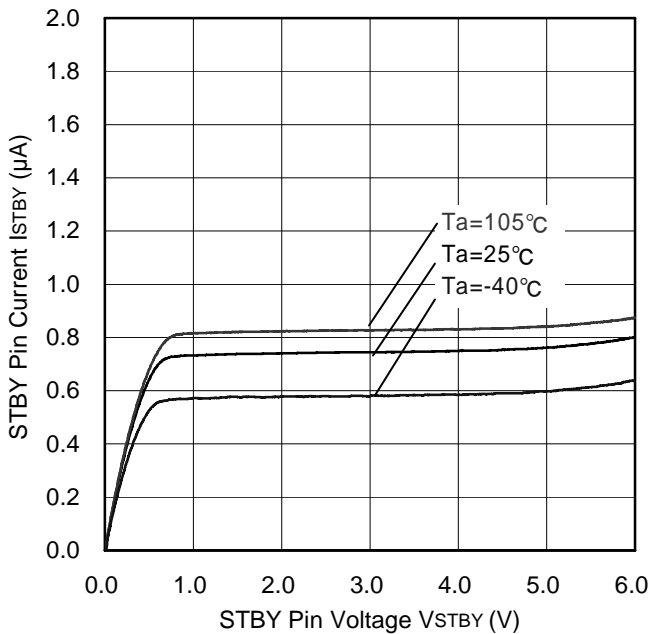

Figure 80. STBY Pin Current vs. STBY Pin Voltage

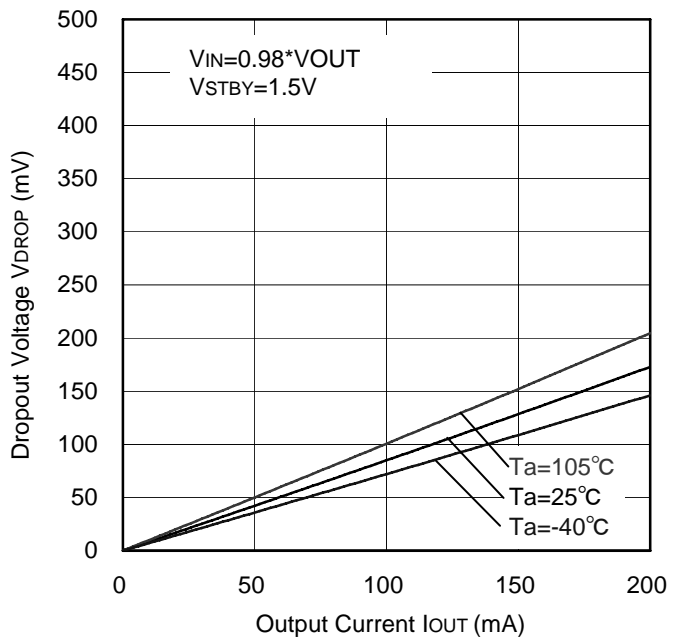

Figure 81. Dropout Voltage vs. Output Current

●Reference data BU33SD2MG-M (Unless otherwise specified, Ta=25°C.)

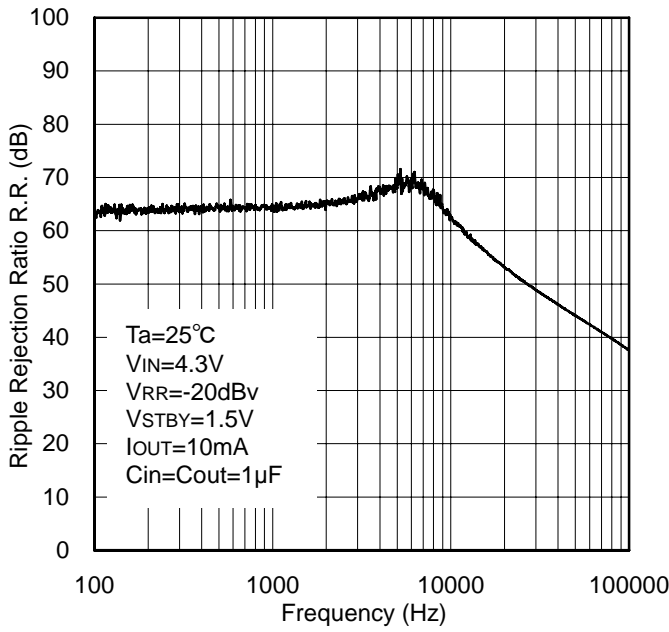

Figure 82. Ripple Rejection Ratio vs. Frequency

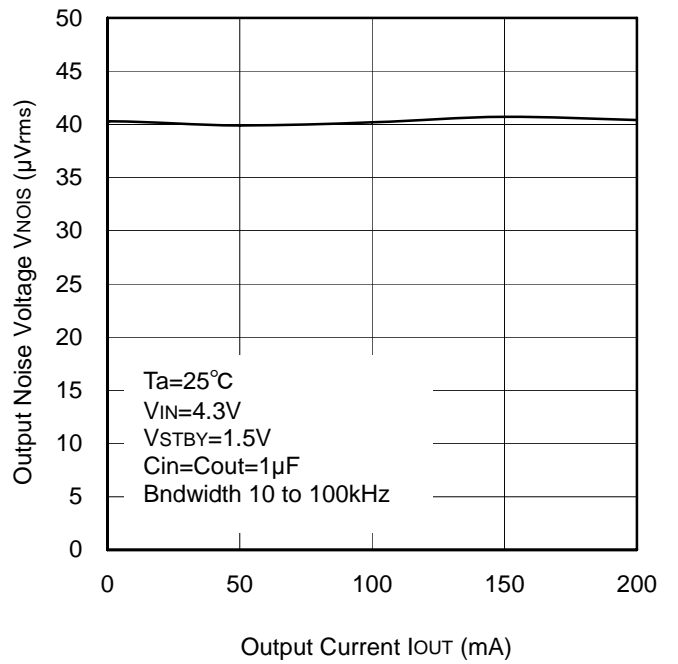

Figure 83. Output Noise Voltage vs. Output Current

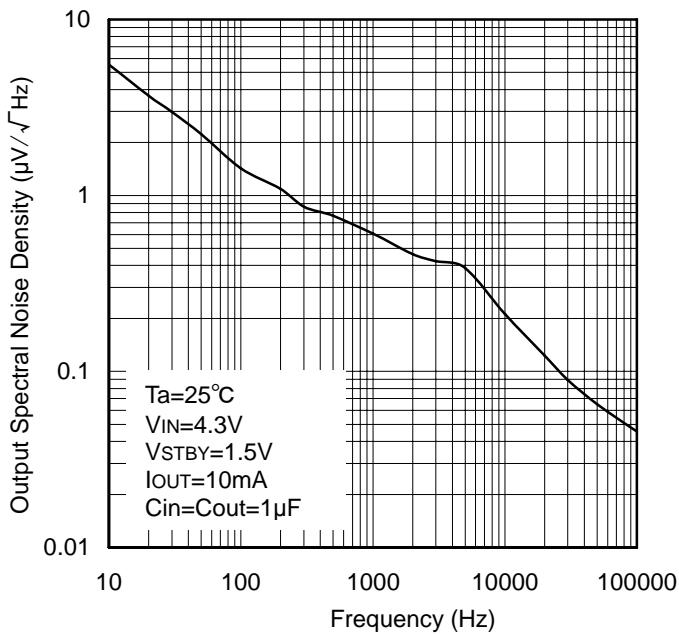

Figure 84. Output Spectral Noise Density vs. Frequency

●Reference data BU33SD2MG-M (Unless otherwise specified, Ta=25°C.)

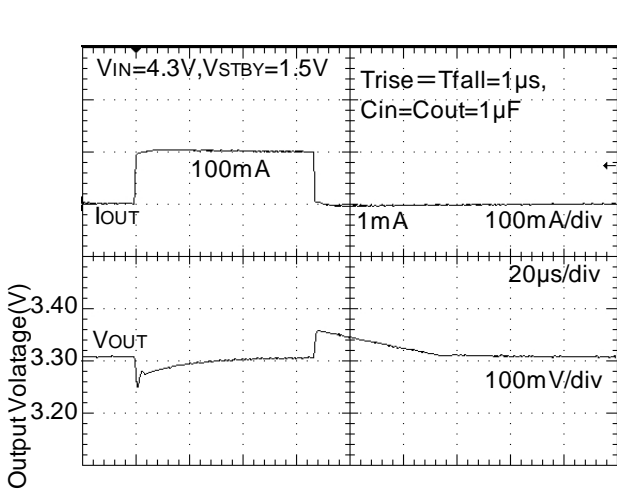

Figure 85. Load Response (1mA to 100mA)

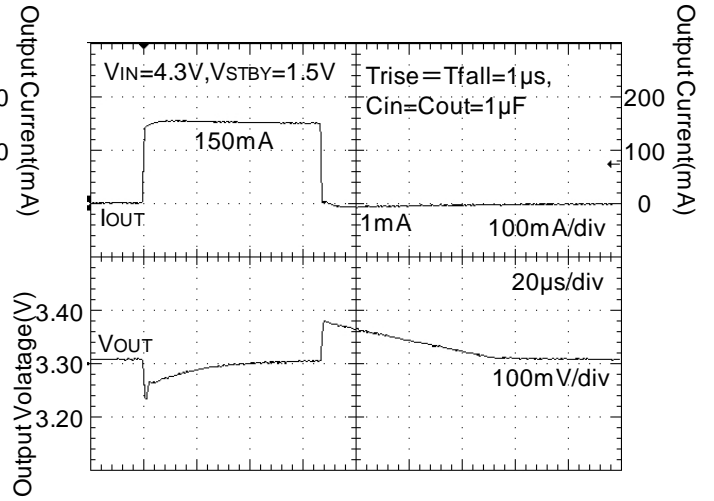

Figure 86. Load Response (1mA to 150mA)

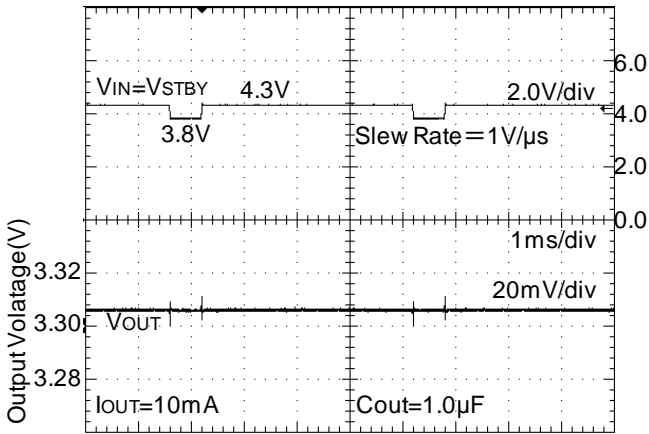

Figure 87. Line Transient Response (3.8 to 4.3V)

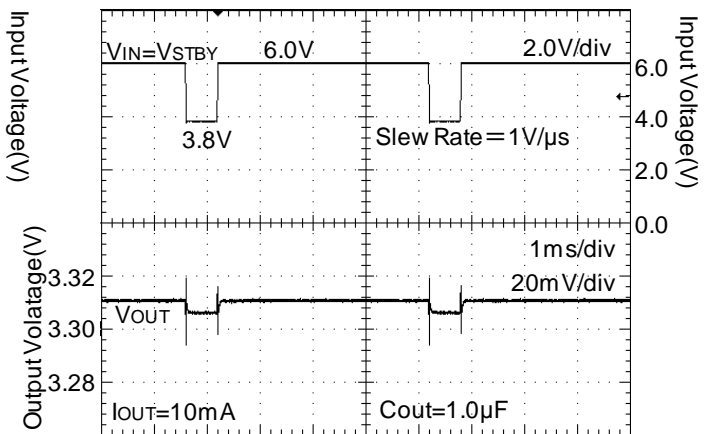

Figure 88. Line Transient Response (3.8 to 6.0V)

●Reference data BU33SD2MG-M (Unless otherwise specified, Ta=25°C.)

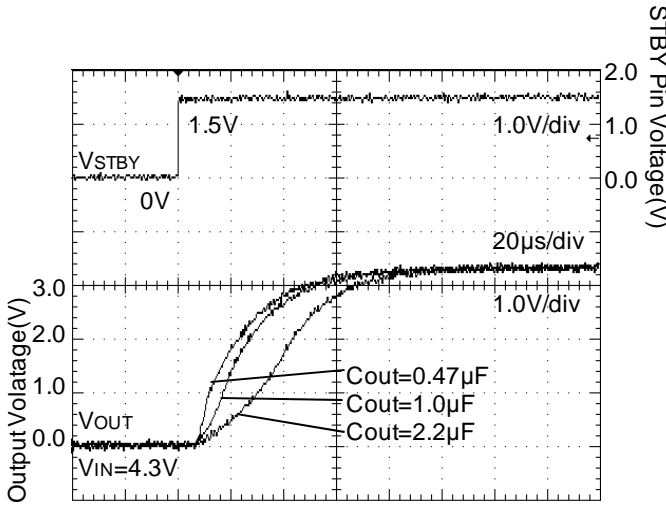

Figure 89. Startup Time (ROUT=none)

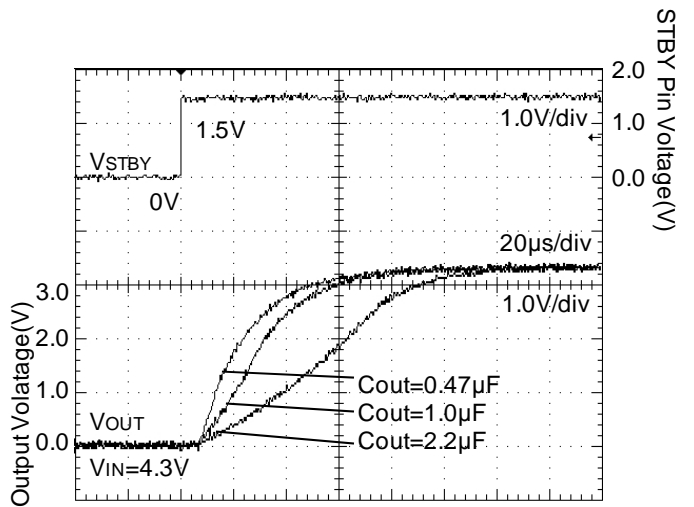

Figure 90. Startup Time (ROUT=16.5Ω)

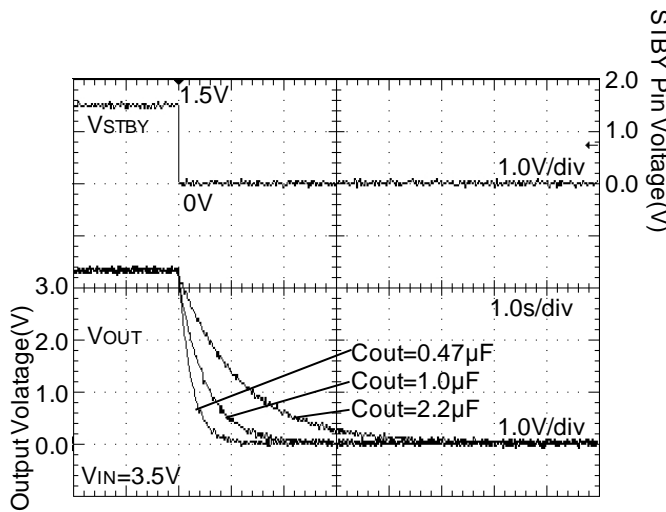

Figure 91. Discharge Time (ROUT=none)

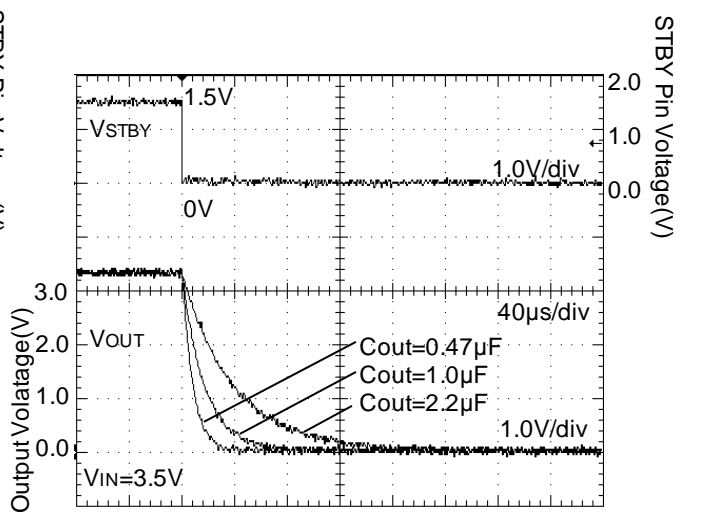

Figure 92. Discharge Time (ROUT=16.5Ω)

●Input/Output Capacitor

It is recommended that an input capacitor is placed near pins between the VCC pin and GND as well as an output capacitor between the output pin and GND. The input is valid when the power supply impedance is high or when the PCB trace has significant length. For the output capacitor, the greater the capacitance, the more stable the output will be depending on the load and line voltage variations. However, please check the actual functionality of this capacitor by mounting it on a board for the actual application. Ceramic capacitors usually have different, thermal and equivalent series resistance characteristics, and may degrade gradually over continued use.

For additional details, please check with the manufacturer, and select the best ceramic capacitor for your application

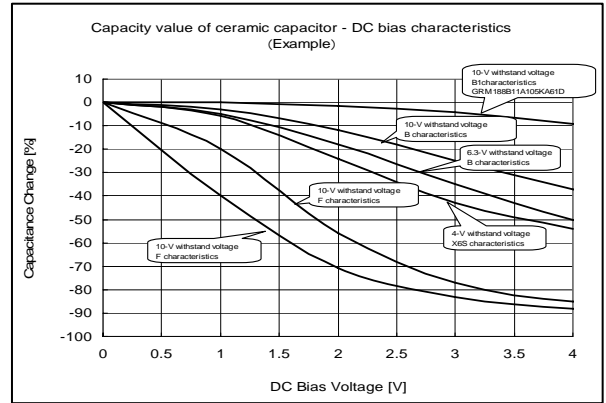

Figure 93. Capacity-bias characteristics

●Equivalent Series Resistance (ESR) of a Ceramic Capacitor

Capacitors generally have ESR (equivalent series resistance) and it operates stably in the ESR-IOUT area shown on the right. Since ceramic capacitors, tantalum capacitors, electrolytic capacitors, etc. generally have different ESR, please check the ESR of the capacitor to be used and use it within the stability area range shown in the right graph for evaluation of the actual application.

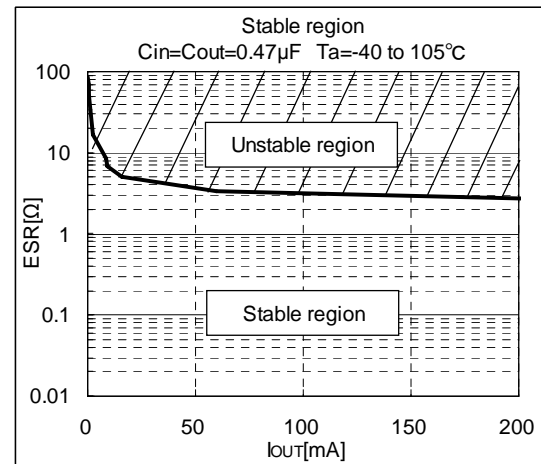

Figure 94. Stability area characteristics (Example)

●Power Dissipation (Pd)

As for power dissipation, an estimate of heat reduction characteristics and internal power consumption of IC are shown, so please use these for reference. Since power dissipation changes substantially depending on the implementation conditions (board size, board thickness, metal wiring rate, number of layers and through holes, etc.), it is recommended to measure Pd on a set board. Exceeding the power dissipation of IC may lead to deterioration of the original IC performance, such as causing the operation of the thermal shutdown circuit or reduction in current capability. Therefore, be sure to prepare sufficient margin within power dissipation for usage.

Calculation of the maximum internal power consumption of IC (P_{MAX})

$P_{MAX} = (V_{IN} - V_{OUT}) \times I_{OMAX}$ Where : V_{IN} =Input voltage V_{OUT} = Output voltage I_{OMAX} : Maximum output current)

○Measurement conditions

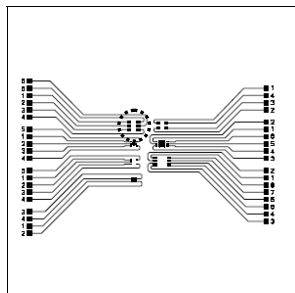
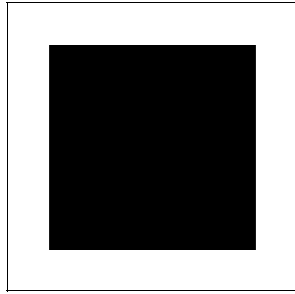
		Standard ROHM Board
Layout of Board for Measurement  IC Implementation Position	 <p>Top Layer (Top View)</p>	
	 <p>Bottom Layer (Top View)</p>	
Measurement State		With board implemented (Wind speed 0 m/s)
Board Material		Glass epoxy resin (Double-side board)
Board Size		70 mm x 70 mm x 1.6 mm
Wiring Rate	Top layer	Metal (GND) wiring rate: Approx. 0%
	Bottom layer	Metal (GND) wiring rate: Approx. 50%
Through Hole		Diameter 0.5mm x 6 holes
Power Dissipation		0.54W
Thermal Resistance		$\theta_{ja} = 185.2^{\circ}\text{C/W}$

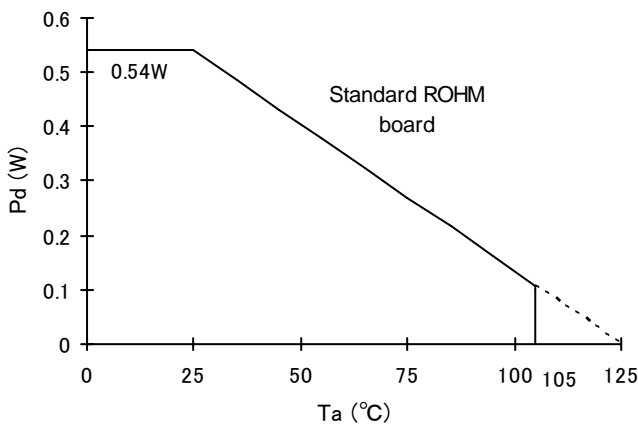

* Please design the margin so that P_{MAX} is less than Pd (P_{MAX}<Pd) within the usage temperature range

Figure 95. SSOP5 Power dissipation heat reduction characteristics (Reference)

● I/O Equivalence Circuits

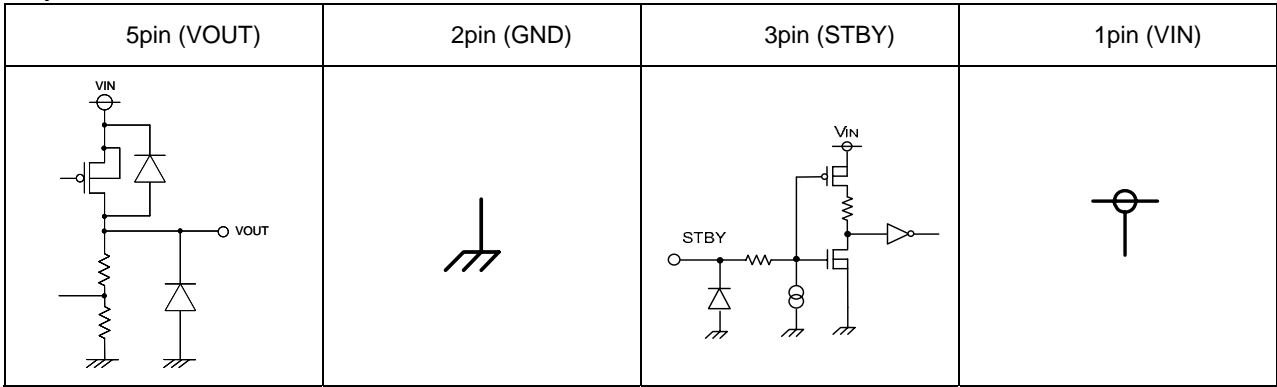
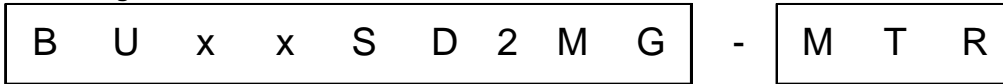

Figure 96. Input / Output equivalent circuit

●Operational Notes

- 1) Absolute maximum ratings
This product is produced with strict quality control, however it may be destroyed if operated beyond its absolute maximum ratings. In addition, it is impossible to predict all destructive situations such as short-circuit modes, open circuit modes, etc. Therefore, it is important to consider circuit protection measures, like adding a fuse, in case the IC is operated in a special mode exceeding the absolute maximum ratings.
- 2) GND Potential
GND potential must be the lowest potential of all pins of the IC at all operating conditions. Ensure that no pins are at a voltage below the ground pin at any time, even during transient condition.
- 3) Setting of Heat
Carry out the heat design that have adequate margin considering Pd of actual working states.
- 4) Pin Short and Mistake Fitting
When mounting the IC on the PCB, pay attention to the orientation of the IC. If there is mistake in the placement, the IC may be burned up.
- 5) Actions in Strong Magnetic Field
Using the IC within a strong magnetic field may cause the IC to malfunction.
- 6) Mutual Impedance
Use short and wide wiring tracks for the power supply and ground to keep the mutual impedance as small as possible. Use a capacitor to keep ripple to a minimum.
- 7) STBY Pin Voltage
To enable standby mode for all channels, set the STBY pin to 0.5 V or less, and for normal operation, to 1.1 V or more. Setting STBY to a voltage between 0.5 and 1.1 V may cause malfunction and should be avoided. Keep transition time between high and low (or vice versa) to a minimum. Additionally, if STBY is shorted to VIN, the IC will switch to standby mode and disable the output discharge circuit, causing a temporary voltage to remain on the output pin. If the IC is switched on again while this voltage is present, overshoot may occur on the output. Therefore, in applications where these pins are shorted, the output should always be completely discharged before turning the IC on.
- 8) Over Current Protection Circuit
Over current and short circuit protection is built-in at the output, and IC destruction is prevented at the time of load short circuit. These protection circuits are effective in the destructive prevention by sudden accidents, please avoid applications to where the over current protection circuit operates continuously.
- 9) Thermal Shutdown
This IC has Thermal Shutdown Circuit (TSD Circuit). When the temperature of IC Chip is higher than 175°C, the output is turned off by TSD Circuit. TSD Circuit is only designed for protecting IC from thermal over load. Therefore it is not recommended that you design application where TSD will work in normal condition.
- 10) Actions under Strong light
A strong light like a halogen lamp may be caused malfunction. In our testing, fluorescence light and white LED causes little effects for the IC, but infrared light causes strong effects on the IC. The IC should be shielded from light like sunrays or halogen lamps.
- 11) Output capacitor
To prevent oscillation at output, it is recommended that the IC be operated at the stable region shown in Figure 94. It operates at the capacitance of more than 0.47μF. As capacitance is larger, stability becomes more stable and characteristic of output load fluctuation is also improved.

●Ordering Information



ROHM Part No.	Output voltage xx=12:1.2V 15:1.5V 18:1.8V 25:2.5V 28:2.8V 30:3.0V 33:3.3V	Series name SD2M:High-speed load response Low noise Shutdown SW	Package G: SSOP5	Grade M;Automotive Accessories	Packaging and forming specifications TR:Embossed tape and reel (SSOP5)
------------------	--	---	---------------------	--------------------------------------	--

●Marking Diagram

xx	Output Voltage	Marking
12	1.2V typ.	M3
15	1.5V typ.	NV
18	1.8V typ.	M4
25	2.5V typ.	M5
28	2.8V typ.	NW
30	3.0V typ.	NX
33	3.3V typ.	NY

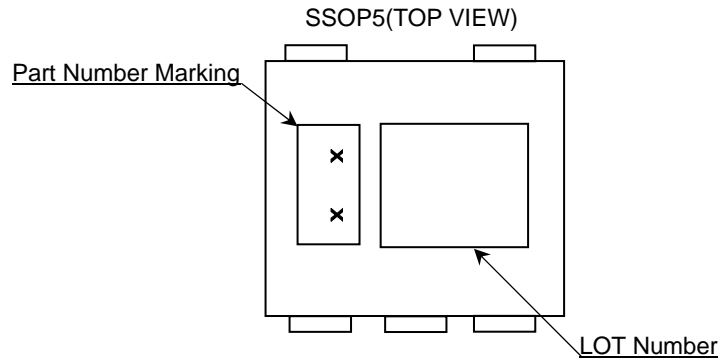

●Physical Dimension Tape and Reel Information

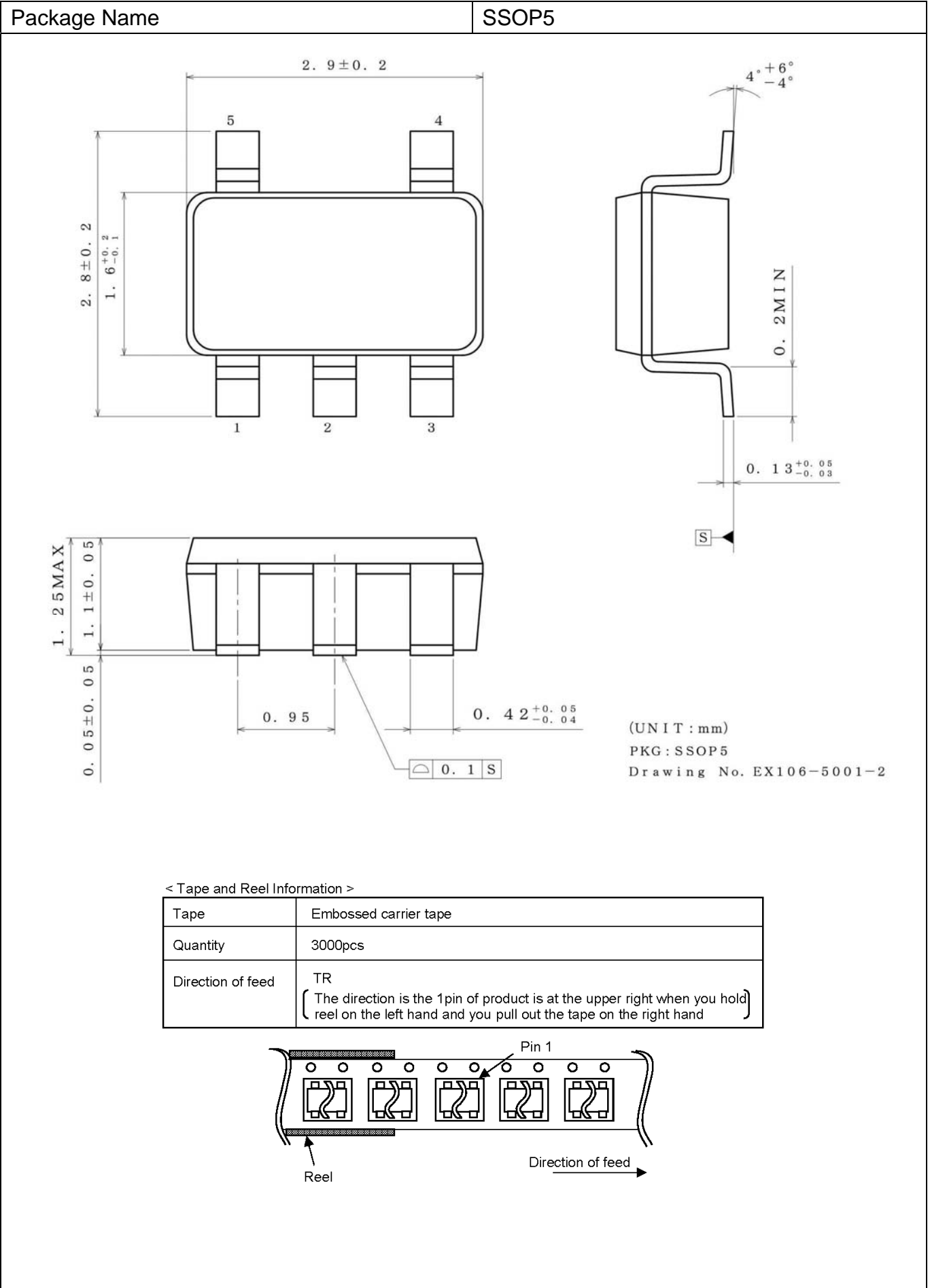

●Revision History

Date	Revision	Changes
21.Dec.2012	001	New Release
19.Mar.2013	002	1) 4 devices (1.5V,2.8V,3.0V,3.3V) are added to the Output Voltage Lineup. 2) Some graphs are added to the Reference data.
17.Feb.2014	003	Graphs about BU33SD2 are added to the Reference data.

Notice

Precaution on using ROHM Products

1. If you intend to use our Products in devices requiring extremely high reliability (such as medical equipment ^(Note 1), aircraft/spacecraft, nuclear power controllers, etc.) and whose malfunction or failure may cause loss of human life, bodily injury or serious damage to property ("Specific Applications"), please consult with the ROHM sales representative in advance. Unless otherwise agreed in writing by ROHM in advance, ROHM shall not be in any way responsible or liable for any damages, expenses or losses incurred by you or third parties arising from the use of any ROHM's Products for Specific Applications.

(Note1) Medical Equipment Classification of the Specific Applications

JAPAN	USA	EU	CHINA
CLASS III	CLASS III	CLASS II b	CLASS III
CLASS IV		CLASS III	

2. ROHM designs and manufactures its Products subject to strict quality control system. However, semiconductor products can fail or malfunction at a certain rate. Please be sure to implement, at your own responsibilities, adequate safety measures including but not limited to fail-safe design against the physical injury, damage to any property, which a failure or malfunction of our Products may cause. The following are examples of safety measures:
 - [a] Installation of protection circuits or other protective devices to improve system safety
 - [b] Installation of redundant circuits to reduce the impact of single or multiple circuit failure
3. Our Products are not designed under any special or extraordinary environments or conditions, as exemplified below. Accordingly, ROHM shall not be in any way responsible or liable for any damages, expenses or losses arising from the use of any ROHM's Products under any special or extraordinary environments or conditions. If you intend to use our Products under any special or extraordinary environments or conditions (as exemplified below), your independent verification and confirmation of product performance, reliability, etc, prior to use, must be necessary:
 - [a] Use of our Products in any types of liquid, including water, oils, chemicals, and organic solvents
 - [b] Use of our Products outdoors or in places where the Products are exposed to direct sunlight or dust
 - [c] Use of our Products in places where the Products are exposed to sea wind or corrosive gases, including Cl₂, H₂S, NH₃, SO₂, and NO₂
 - [d] Use of our Products in places where the Products are exposed to static electricity or electromagnetic waves
 - [e] Use of our Products in proximity to heat-producing components, plastic cords, or other flammable items
 - [f] Sealing or coating our Products with resin or other coating materials
 - [g] Use of our Products without cleaning residue of flux (even if you use no-clean type fluxes, cleaning residue of flux is recommended); or Washing our Products by using water or water-soluble cleaning agents for cleaning residue after soldering
 - [h] Use of the Products in places subject to dew condensation
4. The Products are not subject to radiation-proof design.
5. Please verify and confirm characteristics of the final or mounted products in using the Products.
6. In particular, if a transient load (a large amount of load applied in a short period of time, such as pulse. is applied, confirmation of performance characteristics after on-board mounting is strongly recommended. Avoid applying power exceeding normal rated power; exceeding the power rating under steady-state loading condition may negatively affect product performance and reliability.
7. De-rate Power Dissipation (Pd) depending on Ambient temperature (Ta). When used in sealed area, confirm the actual ambient temperature.
8. Confirm that operation temperature is within the specified range described in the product specification.
9. ROHM shall not be in any way responsible or liable for failure induced under deviant condition from what is defined in this document.

Precaution for Mounting / Circuit board design

1. When a highly active halogenous (chlorine, bromine, etc.) flux is used, the residue of flux may negatively affect product performance and reliability.
2. In principle, the reflow soldering method must be used; if flow soldering method is preferred, please consult with the ROHM representative in advance.

For details, please refer to ROHM Mounting specification

Precautions Regarding Application Examples and External Circuits

1. If change is made to the constant of an external circuit, please allow a sufficient margin considering variations of the characteristics of the Products and external components, including transient characteristics, as well as static characteristics.
2. You agree that application notes, reference designs, and associated data and information contained in this document are presented only as guidance for Products use. Therefore, in case you use such information, you are solely responsible for it and you must exercise your own independent verification and judgment in the use of such information contained in this document. ROHM shall not be in any way responsible or liable for any damages, expenses or losses incurred by you or third parties arising from the use of such information.

Precaution for Electrostatic

This Product is electrostatic sensitive product, which may be damaged due to electrostatic discharge. Please take proper caution in your manufacturing process and storage so that voltage exceeding the Products maximum rating will not be applied to Products. Please take special care under dry condition (e.g. Grounding of human body / equipment / solder iron, isolation from charged objects, setting of Ionizer, friction prevention and temperature / humidity control).

Precaution for Storage / Transportation

1. Product performance and soldered connections may deteriorate if the Products are stored in the places where:
 - [a] the Products are exposed to sea winds or corrosive gases, including Cl₂, H₂S, NH₃, SO₂, and NO₂
 - [b] the temperature or humidity exceeds those recommended by ROHM
 - [c] the Products are exposed to direct sunshine or condensation
 - [d] the Products are exposed to high Electrostatic
2. Even under ROHM recommended storage condition, solderability of products out of recommended storage time period may be degraded. It is strongly recommended to confirm solderability before using Products of which storage time is exceeding the recommended storage time period.
3. Store / transport cartons in the correct direction, which is indicated on a carton with a symbol. Otherwise bent leads may occur due to excessive stress applied when dropping of a carton.
4. Use Products within the specified time after opening a humidity barrier bag. Baking is required before using Products of which storage time is exceeding the recommended storage time period.

Precaution for Product Label

QR code printed on ROHM Products label is for ROHM's internal use only.

Precaution for Disposition

When disposing Products please dispose them properly using an authorized industry waste company.

Precaution for Foreign Exchange and Foreign Trade act

Since our Products might fall under controlled goods prescribed by the applicable foreign exchange and foreign trade act, please consult with ROHM representative in case of export.

Precaution Regarding Intellectual Property Rights

1. All information and data including but not limited to application example contained in this document is for reference only. ROHM does not warrant that foregoing information or data will not infringe any intellectual property rights or any other rights of any third party regarding such information or data. ROHM shall not be in any way responsible or liable for infringement of any intellectual property rights or other damages arising from use of such information or data.:
2. No license, expressly or implied, is granted hereby under any intellectual property rights or other rights of ROHM or any third parties with respect to the information contained in this document.

Other Precaution

1. This document may not be reprinted or reproduced, in whole or in part, without prior written consent of ROHM.
2. The Products may not be disassembled, converted, modified, reproduced or otherwise changed without prior written consent of ROHM.
3. In no event shall you use in any way whatsoever the Products and the related technical information contained in the Products or this document for any military purposes, including but not limited to, the development of mass-destruction weapons.
4. The proper names of companies or products described in this document are trademarks or registered trademarks of ROHM, its affiliated companies or third parties.

General Precaution

1. Before you use our Products, you are requested to carefully read this document and fully understand its contents. ROHM shall not be in any way responsible or liable for failure, malfunction or accident arising from the use of any ROHM's Products against warning, caution or note contained in this document.
2. All information contained in this document is current as of the issuing date and subject to change without any prior notice. Before purchasing or using ROHM's Products, please confirm the latest information with a ROHM sales representative.
3. The information contained in this document is provided on an "as is" basis and ROHM does not warrant that all information contained in this document is accurate and/or error-free. ROHM shall not be in any way responsible or liable for any damages, expenses or losses incurred by you or third parties resulting from inaccuracy or errors of or concerning such information.

Mouser Electronics

Authorized Distributor

Click to View Pricing, Inventory, Delivery & Lifecycle Information:

[ROHM Semiconductor:](#)

[BU15SD2MG-MTR](#) [BU28SD2MG-MTR](#) [BU12SD2MG-MTR](#) [BU30SD2MG-MTR](#) [BU18SD2MG-MTR](#) [BU25SD2MG-MTR](#) [BU33SD2MG-MTR](#)