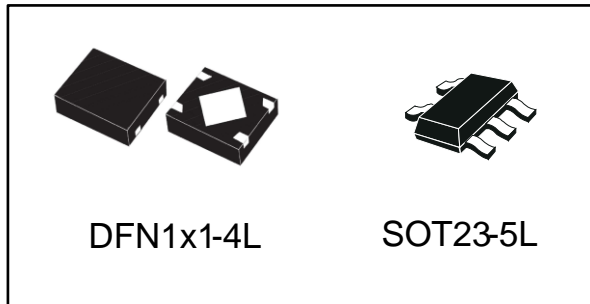

200 mA very low quiescent current linear regulator IC

Datasheet - production data

**Features**

- Input voltage from 1.5 to 5.5 V
- Ultra low dropout voltage (200 mV typ. at 200 mA load)
- Very low quiescent current (20 μ A typ at no load, 0.03 μ A typ in off mode)
- Output voltage tolerance: $\pm 0.5\%$ (A version) or $\pm 2.0\%$ @ 25 $^{\circ}$ C (standard version)
- 200 mA guaranteed output current
- High PSRR (80 dB@1 kHz, 50 db@100 kHz)
- Wide range of output voltages available on request: from 0.8 V up to 5.0 V in 50 mV step
- Logic-controlled electronic shutdown
- Internal soft-start
- Optional output voltage discharge feature
- Compatible with ceramic capacitor $C_{OUT} = 0.47 \mu$ F
- Internal constant current and thermal protections
- Available in DFN 1x1-4L and SOT23-5L
- Operating temperature range: -40 $^{\circ}$ C to 125 $^{\circ}$ C

Applications

- Mobile phones
- Personal digital assistants (PDAs)
- Digital still cameras (DSC)
- Cordless phones and similar battery-powered systems
- Portable media players

Description

The LD39020 high accuracy voltage regulator provides 200 mA of maximum current from an input voltage ranging from 1.5 V to 5.5 V, with a typical dropout voltage of 200 mV.

It is available in DFN 1x1-4L and SOT23-5L packages, allowing the maximum space saving.

The device is stabilized with a ceramic capacitor on the output. The ultra low drop voltage, low quiescent current and low noise features, together with the internal soft-start circuit, make the LD39020 suitable for low power battery-operated applications.

An enable logic control function puts the LD39020 in shutdown mode allowing a total current consumption lower than 0.1 μ A. Constant current and thermal protection are provided.

Contents

1	Diagram	5
2	Pin configuration	6
3	Typical application	7
4	Maximum ratings	8
5	Electrical characteristics	9
6	Application information	12
	6.1 Soft start function	12
	6.2 Output discharge function	12
	6.3 Input and output capacitors	12
7	Typical characteristics	13
8	Package information	18
	8.1 DFN4 1x1-4L package information.....	19
	8.2 SOT23-5L package information	22
	8.3 SOT23-5L packing information.....	24
9	Order code	25
10	Revision history	29

List of tables

Table 1: Pin description	6
Table 2: Absolute maximum ratings	8
Table 3: Thermal data.....	8
Table 4: ESD Performance.....	8
Table 5: Electrical characteristics for LD39020T, LD39020DT.....	9
Table 6: Electrical characteristics for LD39020AT, LD39020ADT	10
Table 7: DFN 1x1-4L mechanical data	20
Table 8: SOT23-5L mechanical data	22
Table 9: SOT23-5L tape and reel mechanical data.....	24
Table 10: DFN1x1-4L order code	25
Table 11: SOT23-5L order code	28
Table 12: Document revision history	29

List of figures

Figure 1: Block diagram	5
Figure 2: Pin connection (top view)	6
Figure 3: Typical application circuits	7
Figure 4: Output voltage vs. temperature ($I_{OUT} = 1 \text{ mA}$)	13
Figure 5: Output voltage vs. temperature ($I_{OUT} = 200 \text{ mA}$)	13
Figure 6: Line regulation vs. temperature	13
Figure 7: Load regulation vs. temperature	13
Figure 8: Quiescent current vs. temperature ($I_{OUT} = 0 \text{ mA}$)	14
Figure 9: Quiescent current vs. temperature ($I_{OUT} = 200 \text{ mA}$)	14
Figure 10: Shutdown current vs. temperature	14
Figure 11: Quiescent current vs. load current	14
Figure 12: Quiescent current vs. input voltage	14
Figure 13: Dropout voltage vs temperature	14
Figure 14: Supply voltage rejection vs. frequency	15
Figure 15: Supply voltage rejection vs. input voltage	15
Figure 16: Output noise spectral density	15
Figure 17: Stability area vs (C_{OUT} , ESR)	15
Figure 18: Enable startup ($V_{OUT} = 1 \text{ V}$)	15
Figure 19: Enable startup ($V_{OUT} = 5 \text{ V}$)	15
Figure 20: Turn-on time ($V_{OUT} = 1 \text{ V}$)	16
Figure 21: Turn-off time ($V_{OUT} = 1 \text{ V}$)	16
Figure 22: Turn-on time ($V_{OUT} = 5 \text{ V}$)	16
Figure 23: Turn-off time ($V_{OUT} = 5 \text{ V}$)	16
Figure 24: Line transient ($V_{OUT} = 1 \text{ V}$)	16
Figure 25: Line transient ($V_{OUT} = 5 \text{ V}$)	16
Figure 26: Load transient ($V_{OUT} = 1 \text{ V}$)	17
Figure 27: Load transient ($V_{OUT} = 5 \text{ V}$)	17
Figure 28: DFN 1x1-4L package outline	19
Figure 29: DFN 1x1-4L recommended footprint	21
Figure 30: SOT23-5L package outline	22
Figure 31: SOT23-5L recommended footprint	23
Figure 32: SOT23-5L tape and reel outline	24

1 Diagram

Figure 1: Block diagram

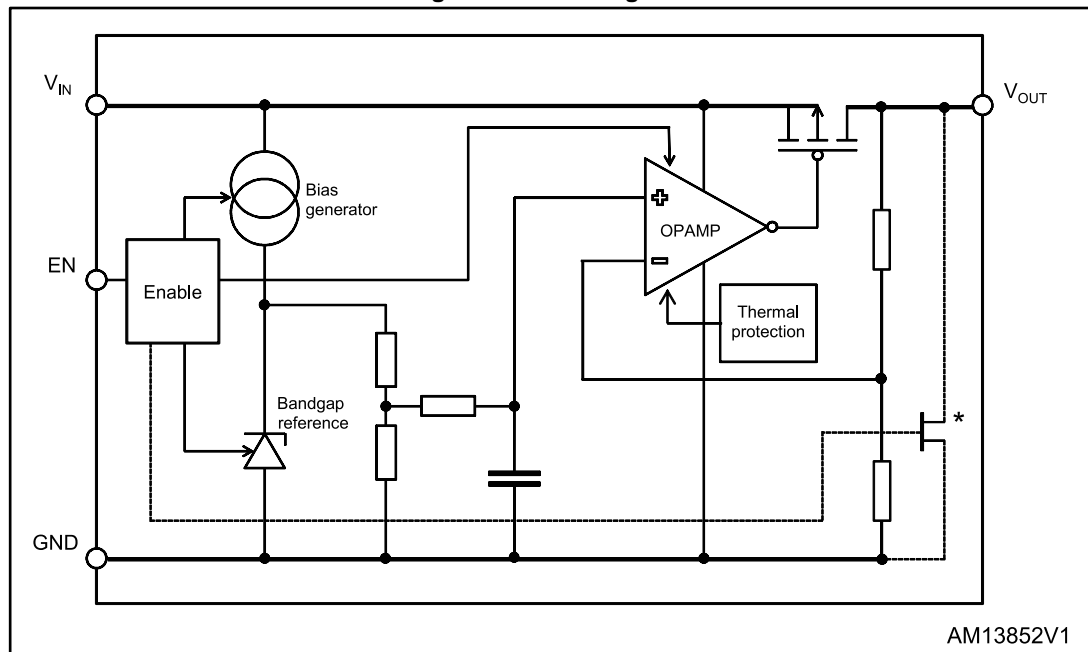

The output discharge MOSFET is optional.

2 Pin configuration

Figure 2: Pin connection (top view)

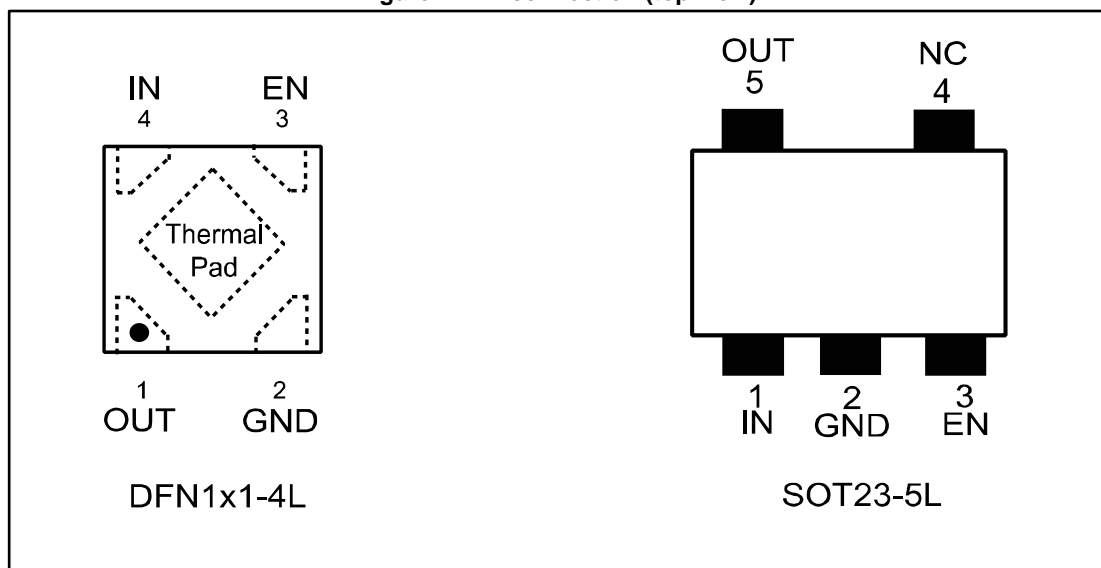
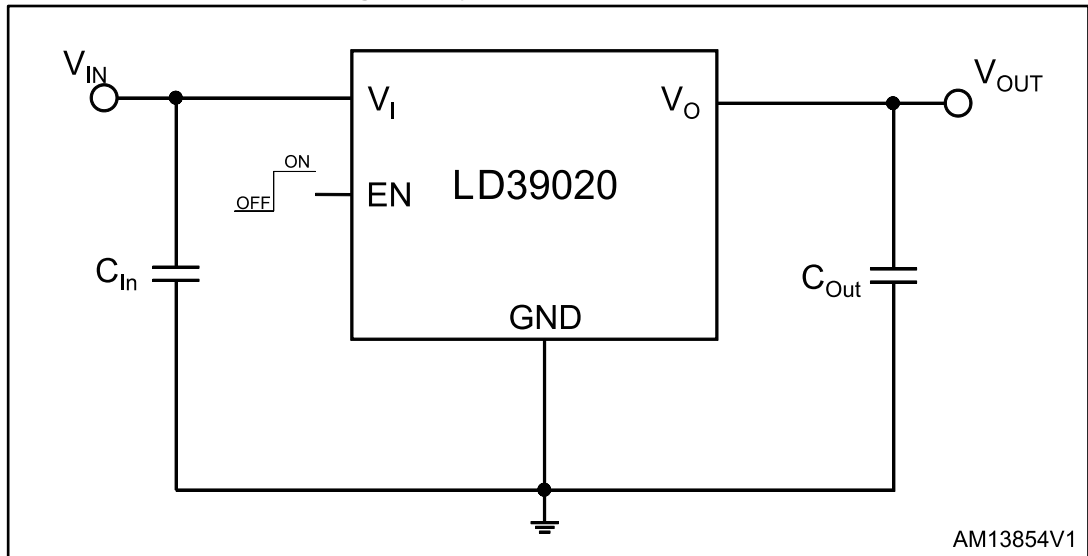

Table 1: Pin description

Pin n° DFN1x1-4L	Pin n° SOT23-5L	Symbol	Function
1	5	OUT	Output voltage
2	2	GND	Common ground
3	3	EN	Enable pin logic input: low = shutdown, High = active
4	1	IN	Input voltage
Thermal pad	-	GND	Connect to GND on the PCB
-	4	NC	Not connected

3 Typical application

Figure 3: Typical application circuits



4 Maximum ratings

Table 2: Absolute maximum ratings

Symbol	Parameter	Value	Unit
V _{IN}	Input voltage	- 0.3 to 7	V
V _{OUT}	Output voltage	- 0.3 to V _{IN} + 0.3	V
V _{EN}	Enable input voltage	- 0.3 to 7	V
I _{OUT}	Output current	Internally limited	mA
P _D	Power dissipation	Internally limited	mW
T _{STG}	Storage temperature range	- 40 to 150	°C
T _{OP}	Operating junction temperature range	- 40 to 125	°C



Absolute maximum ratings are those values beyond which damage to the device may occur. Functional operation under these conditions is not implied. All values are referred to GND.

Table 3: Thermal data

Symbol	Parameter	Value	Unit
R _{thJA}	Thermal resistance junction-ambient, DFN1x1-4L	250	°C/W
R _{thJC}	Thermal resistance junction-case, SOT23-5L	81	°C/W
R _{thJA}	Thermal resistance junction-ambient, SOT23-5L	255	°C/W

Table 4: ESD Performance

Symbol	Parameter	Test conditions	Value	Unit
ESD	ESD Protection voltage	HBM	4	kV
		MM	400	V
		CDM	500	V

5 Electrical characteristics

$T_J = 25\text{ °C}$, $V_{IN} = V_{OUT(NOM)} + 1\text{ V}$, $C_{IN} = C_{OUT} = 1\text{ }\mu\text{F}$, $I_{OUT} = 1\text{ mA}$, $V_{EN} = V_{IN}$, unless otherwise specified.

Table 5: Electrical characteristics for LD39020T, LD39020DT

Symbol	Parameter	Test conditions	Min.	Typ.	Max.	Unit
V_{IN}	Operating input voltage		1.5		5.5	V
V_{OUT}	V_{OUT} accuracy	$I_{OUT} = 1\text{ mA}$, $T_J = 25\text{ °C}$	-2		2	%
		$I_{OUT} = 1\text{ mA}$, $-40\text{ °C} < T_J < 125\text{ °C}$	-3		3	%
ΔV_{OUT}	Static line regulation ⁽¹⁾	$V_{OUT(NOM)} + 1\text{ V} \leq V_{IN} \leq 5.5\text{ V}$, $I_{OUT} = 10\text{ mA}$		0.02		%/V
		$-40\text{ °C} < T_J < 125\text{ °C}$			0.2	
ΔV_{OUT}	Static load regulation	$I_{OUT} = 0\text{ mA}$ to 200 mA		10		mV
		$-40\text{ °C} < T_J < 125\text{ °C}$			0.01	%/mA
V_{DROP}	Dropout voltage	$I_{OUT} = 30\text{ mA}$, $V_{OUT} = 2.8\text{ V}$		35		mV
		$I_{OUT} = 200\text{ mA}$, $V_{OUT} = 2.8\text{ V}$ $-40\text{ °C} < T_J < 125\text{ °C}$		200	350	
e_N	Output noise voltage	10 Hz to 100 kHz, $I_{OUT} = 10\text{ mA}$		45		μVRMS
SVR	Supply voltage rejection	$V_{IN} = V_{OUT(NOM)} + 1\text{ V} \pm V_{RIPPLE}$ $V_{RIPPLE} = 0.2\text{ V}$ Freq. = 1 kHz $I_{OUT} = 30\text{ mA}$		80		dB
		$V_{IN} = V_{OUT(NOM)} + 1\text{ V} \pm V_{RIPPLE}$ $V_{RIPPLE} = 0.2\text{ V}$ Freq. = 100 kHz $I_{OUT} = 30\text{ mA}$		55		
I_Q	Quiescent current	$I_{OUT} = 0\text{ mA}$		20	40	μA
		$I_{OUT} = 200\text{ mA}$		100		
$I_{Standby}$	Standby Current	V_{IN} input current in OFF MODE: $V_{EN} = \text{GND}$		0.03	1	μA
I_{SC}	Short circuit current	$R_L = 0$	250	350		mA
R_{ON}	Output voltage discharge MOSFET	(only on LD39020DT)		100		Ω
V_{EN}	Enable input logic low	$V_{IN} = 1.5\text{ V}$ to 5.5 V $-40\text{ °C} < T_J < 125\text{ °C}$			0.4	V
	Enable input logic high	$V_{IN} = 1.5\text{ V}$ to 5.5 V $-40\text{ °C} < T_J < 125\text{ °C}$	1			
I_{EN}	Enable pin input current	$V_{EN} = V_{IN}$			100	nA
T_{ON} ⁽²⁾	Turn on time			100		μs
T_{SHDN}	Thermal shutdown			160		$^{\circ}\text{C}$
	Hysteresis			20		

Symbol	Parameter	Test conditions	Min.	Typ.	Max.	Unit
C _{OUT}	Output capacitor	Capacitance (see Figure 17: "Stability area vs (C_{OUT}, ESR)")	0.47		22	μF

Notes:

⁽¹⁾Not applicable for V_{out(nom)} > 4.5 V

⁽²⁾Turn-on time is time measured between the enable input just exceeding V_{EN} high value and the output voltage just reaching 95 % of its nominal value

T_J = 25 °C, V_{IN} = V_{OUT(NOM)} + 1 V, C_{IN} = C_{OUT} = 1 μF, I_{OUT} = 1 mA, V_{EN} = V_{IN}, unless otherwise specified.

Table 6: Electrical characteristics for LD39020AT, LD39020ADT

Symbol	Parameter	Test conditions	Min.	Typ.	Max.	Unit
V _{IN}	Operating input voltage		1.5		5.5	V
V _{OUT}	V _{OUT} accuracy	I _{OUT} = 1 mA, T _J = 25 °C	-0.5		0.5	%
		I _{OUT} = 1 mA, -40 °C < T _J < 125 °C	-1.5		1.5	%
ΔV _{OUT}	Static line regulation ⁽¹⁾	V _{OUT(NOM)} + 1 V ≤ V _{IN} ≤ 5.5 V, I _{OUT} = 10 mA		0.02		%/V
		-40 °C < T _J < 125 °C			0.2	
ΔV _{OUT}	Static load regulation	I _{OUT} = 0 mA to 200 mA		10		mV
		-40 °C < T _J < 125 °C			0.01	%/mA
V _{DROP}	Dropout voltage	I _{OUT} = 30 mA, V _{OUT} = 2.8 V		35		mV
		I _{OUT} = 200 mA, V _{OUT} = 2.8 V -40 °C < T _J < 125 °C		200	350	
e _N	Output noise voltage	10 Hz to 100 kHz, I _{OUT} = 10 mA		45		μVRMS
SVR	Supply voltage rejection	V _{IN} = V _{OUT(NOM)} + 1 V +/- V _{RIPPLE} V _{RIPPLE} = 0.2 V Freq. = 1 kHz I _{OUT} = 30 mA		80		dB
		V _{IN} = V _{OUT(NOM)} + 1 V +/- V _{RIPPLE} V _{RIPPLE} = 0.2 V Freq. = 100 kHz I _{OUT} = 30 mA		55		
I _Q	Quiescent current	I _{OUT} = 0 mA		20	40	μA
		I _{OUT} = 200 mA		100		
I _{standby}	Standby current	V _{IN} input current in OFF MODE: V _{EN} = GND		0.03	1	μA
I _{SC}	Short circuit current	R _L = 0	250	350		mA
R _{ON}	Output voltage discharge MOSFET	(only on LD39020ADT)		100		Ω

Symbol	Parameter	Test conditions	Min.	Typ.	Max.	Unit
V _{EN}	Enable input logic low	V _{IN} = 1.5 V to 5.5 V -40 °C < T _J < 125 °C			0.4	V
	Enable input logic high	V _{IN} = 1.5 V to 5.5 V -40 °C < T _J < 125 °C	1			
I _{EN}	Enable pin input current	V _{EN} = V _{IN}			100	nA
TON ⁽²⁾	Turn on time			100		μs
T _{SHDN}	Thermal shutdown			160		°C
	Hysteresis			20		
C _{OUT}	Output capacitor	Capacitance (see <i>Figure 17: "Stability area vs (C_{OUT}, ESR)"</i>)	0.47		22	μF

Notes:

⁽¹⁾Not applicable for V_{out}(nom) > 4.5 V

⁽²⁾Turn-on time is time measured between the enable input just exceeding V_{EN} high value and the output voltage just reaching 95 % of its nominal value

6 Application information

6.1 Soft start function

The LD39020 has an internal soft start circuit. By increasing the startup time up to 100 μ s, without the need of any external soft start capacitor, this feature is able to keep the regulator inrush current at startup under control.

6.2 Output discharge function

The LD39020 integrates a MOSFET connected between Vout and GND. This transistor is activated when the EN pin goes to low logic level and has the function to quickly discharge the output capacitor when the device is disabled by the user.

The device is available with or without auto-discharge feature.

See [Table 10: "DFN1x1-4L order codes"](#) for more details.

6.3 Input and output capacitors

The LD39020 requires external capacitors to assure the regulator control loop stability.

Any good quality ceramic capacitor can be used but, the X5R and the X7R are suggested since they guarantee a very stable combination of capacitance and ESR overtemperature.

Locating the input/output capacitors as closer as possible to the relative pins is recommended.

The LD39020 requires an input capacitor with a minimum value of 1 μ F.

This capacitor must be located as closer as possible to the input pin of the device and returned to a clean analog ground.

The control loop of the LD39020 is designed to work with an output ceramic capacitor.

This capacitor must meet the requirements of minimum capacitance and equivalent series resistance (ESR), as shown in Fig17. To assure stability, the output capacitor must maintain its ESR and capacitance in the stable region, over the full operating temperature range.

The LD39020 shows stability with a minimum effective output capacitance of 220 nF.

However, to keep stability in all operating conditions (temperature, input voltage and load variations), a minimum output capacitor of 0.47 μ F is recommended.

The suggested combination of 1 μ F input and output capacitors offers a good compromise among the stability of the regulator, optimum transient response and total PCB area occupation.

7 Typical characteristics

($C_{IN} = C_{OUT} = 1 \mu F$, V_{EN} to V_{IN} , $T_J = 25^\circ C$ unless otherwise specified)

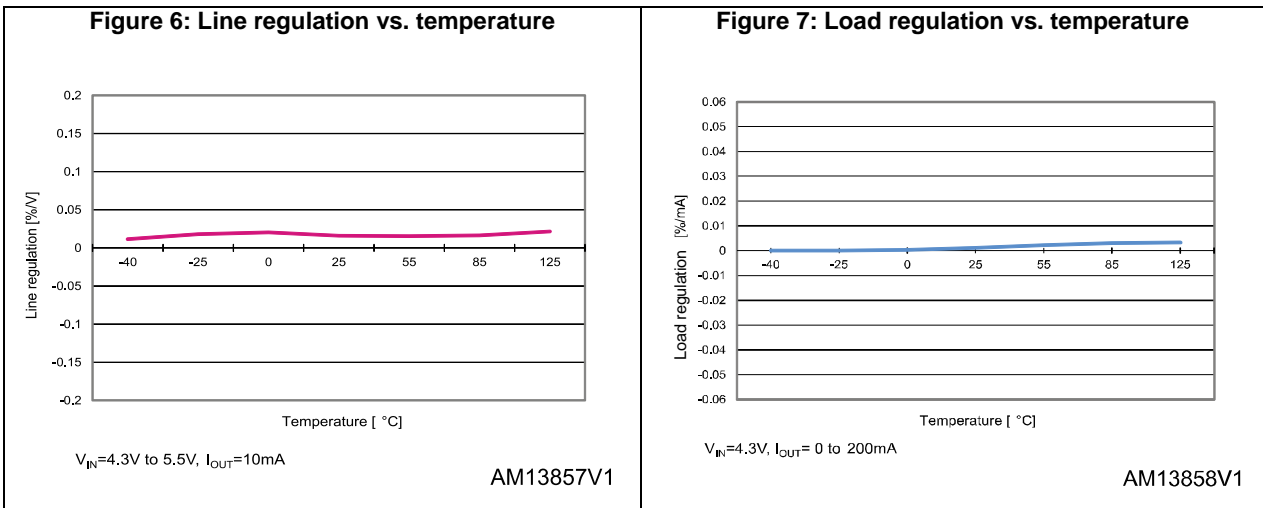
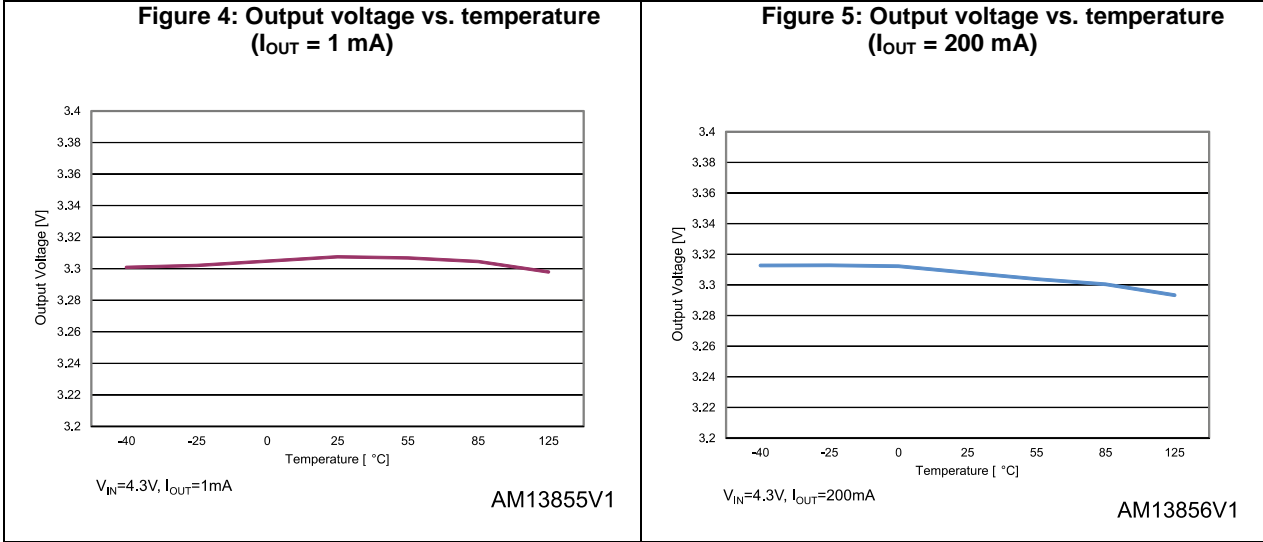

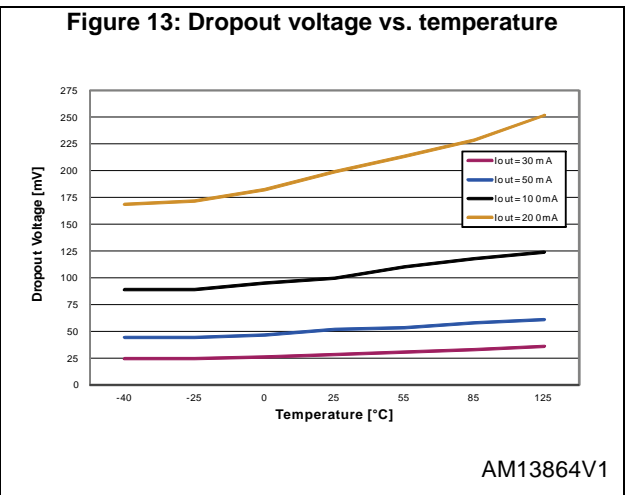
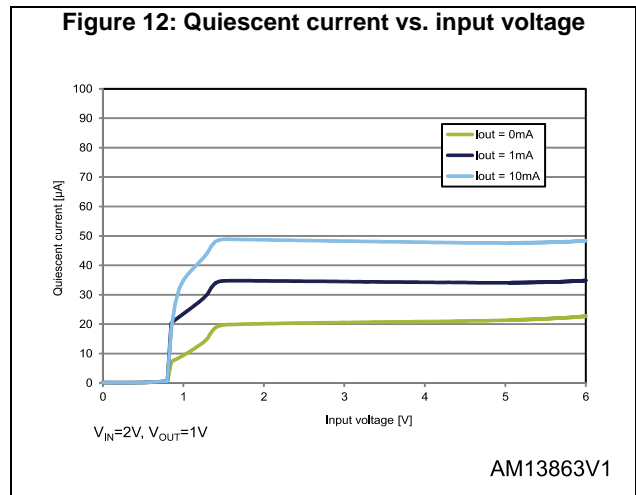
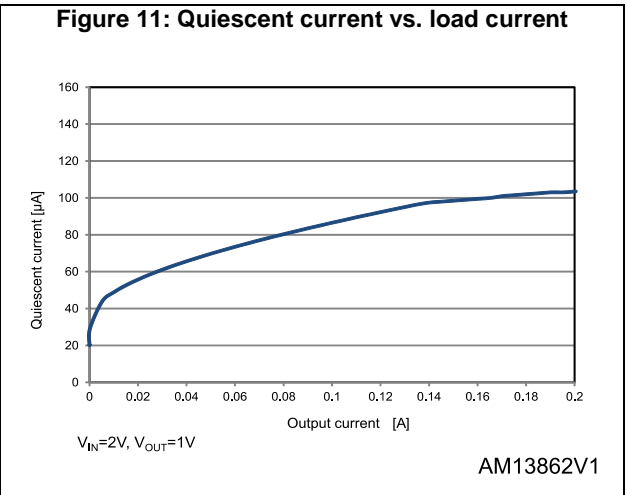
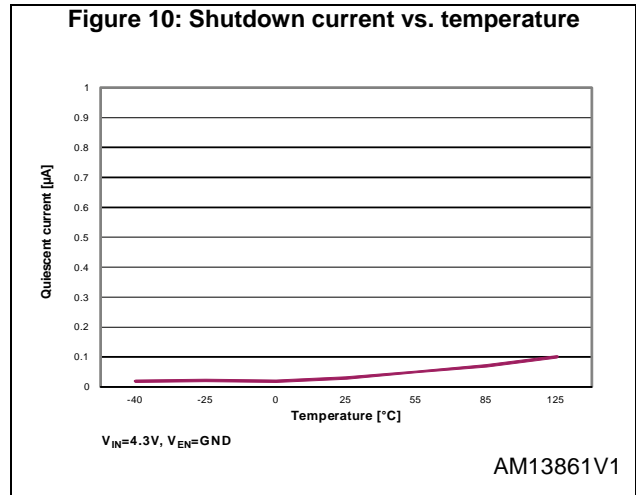
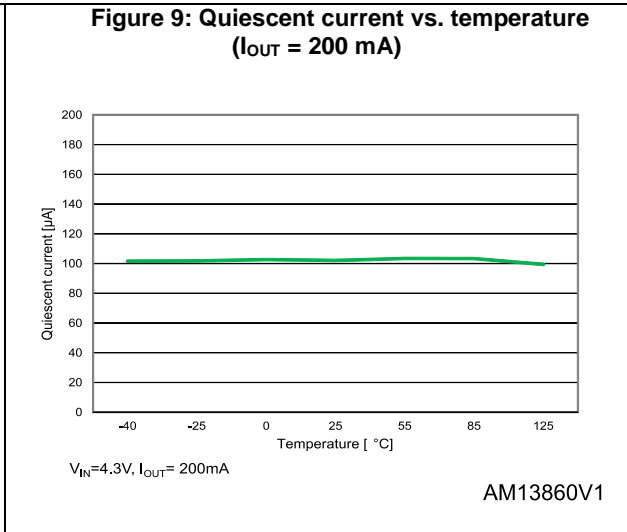
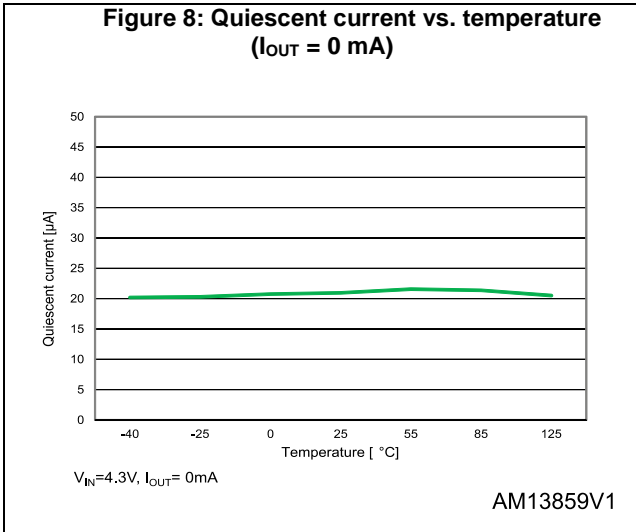
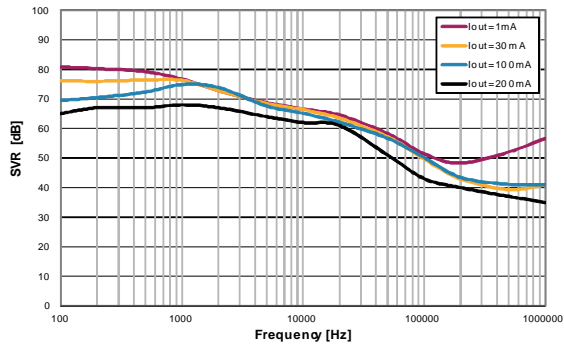

Figure 14: Supply voltage rejection vs. frequency



$V_{IN}=2V \pm 200mV$, $V_{OUT}=1V$, $C_{OUT}=1\mu F$

AM13865V1

Figure 15: Supply voltage rejection vs. input voltage

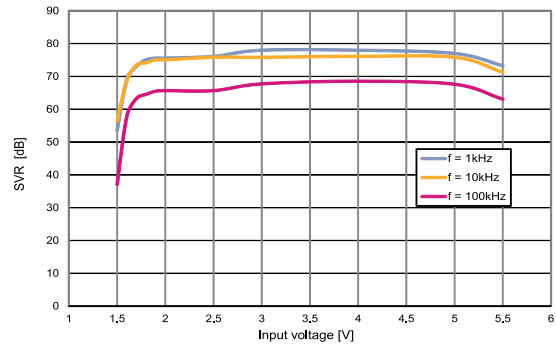

$I_{OUT}=30mA$, $V_{OUT}=1V$, $C_{OUT}=1\mu F$

AM13866V1

Figure 16: Output noise spectral density

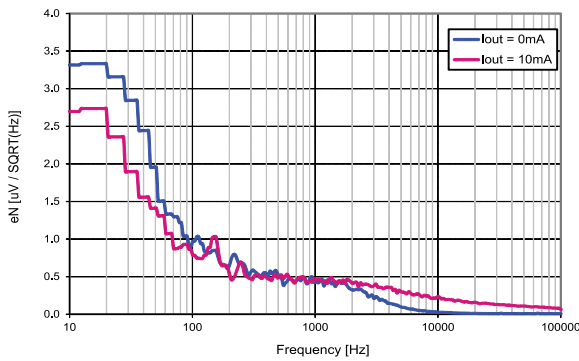

$V_{IN}=2.0V$, $V_{OUT}=1.0V$, $C_{IN}=C_{OUT}=1\mu F$

AM13867V1

Figure 17: Stability area vs. (C_{OUT}, ESR)

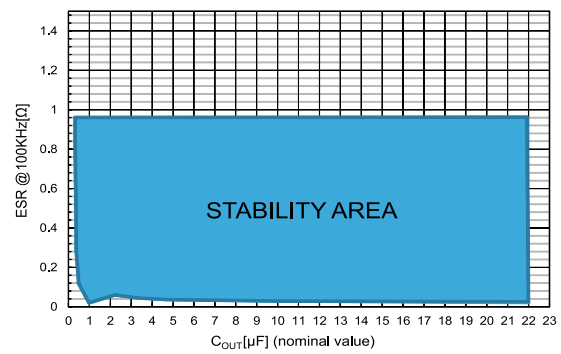

V_{IN} from 2 to 5.5V, I_{OUT} from 0 to 200mA, $C_{IN}=1\mu F$

AM13868V1

Figure 18: Enable startup ($V_{OUT} = 1V$)

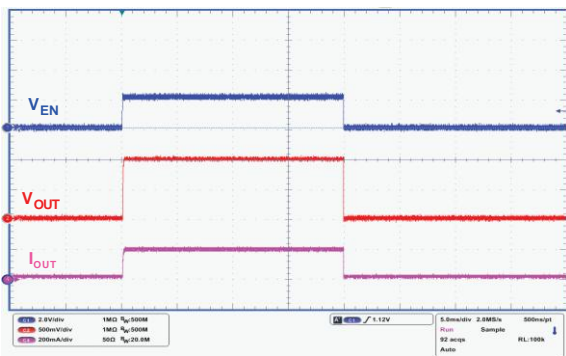

$V_{IN}=2V$, $V_{EN}=0V$ to V_{IN} , $I_{OUT}=0.2A$, $V_{OUT}=1V$, $T_r=5\mu s$

AM13869V1

Figure 19: Enable startup ($V_{OUT} = 5V$)

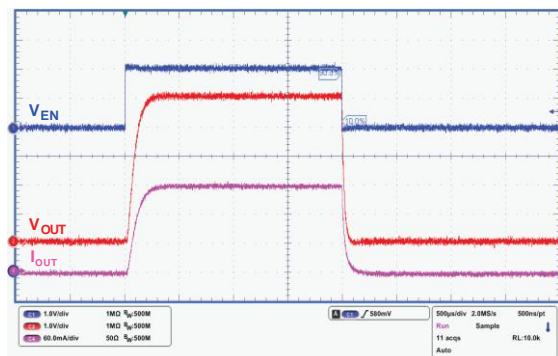

$V_{IN}=5.5V$, $V_{EN}=0V$ to $2V$, $I_{OUT}=0.2A$, $V_{OUT}=5V$, $T_r=5\mu s$

AM13870V1

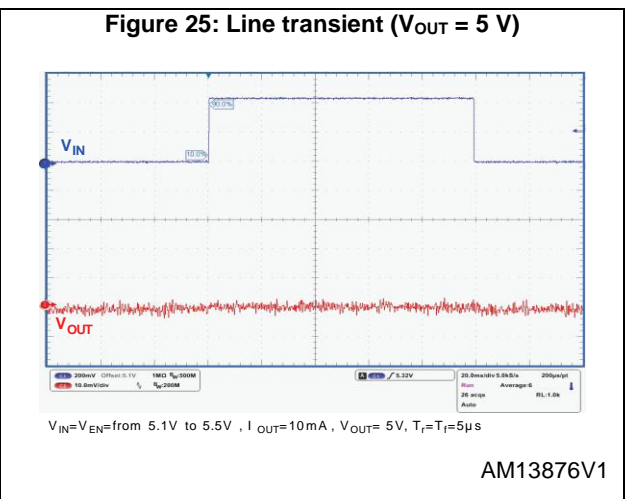
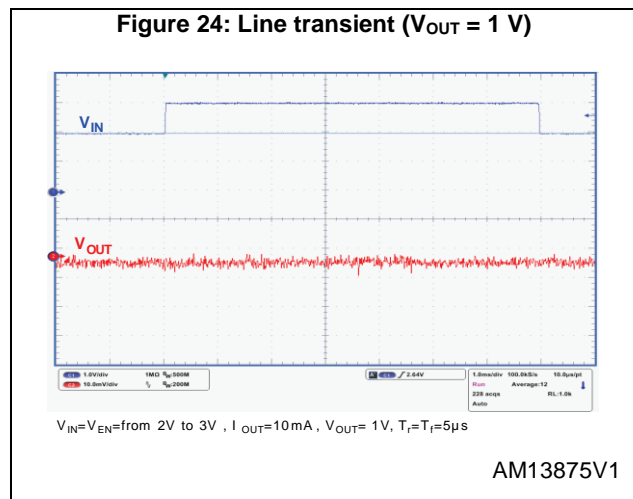
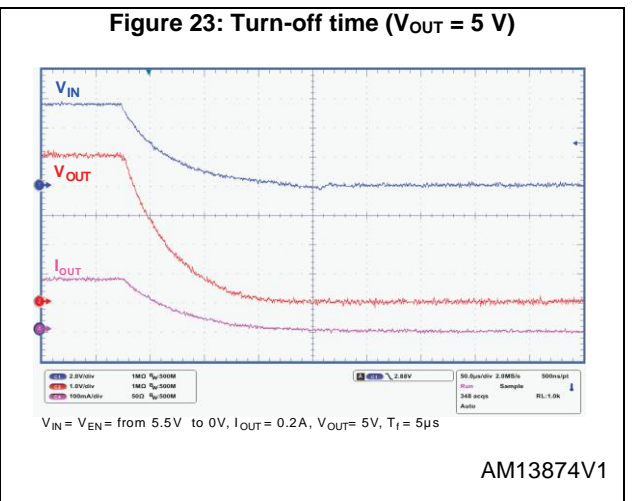
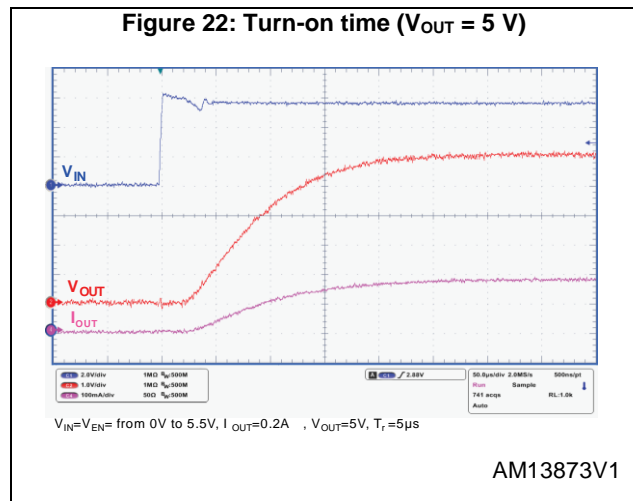
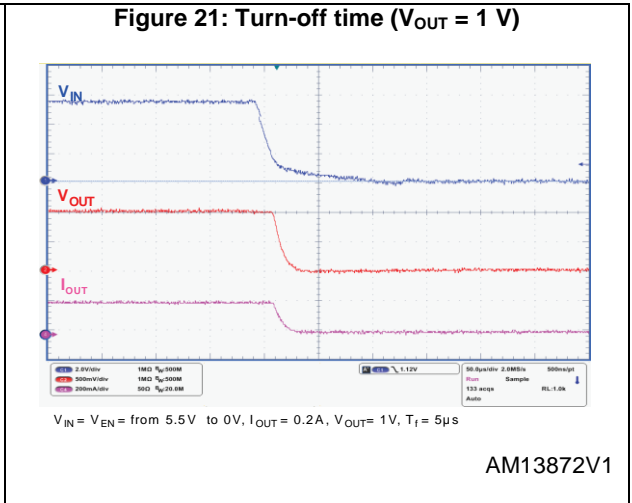
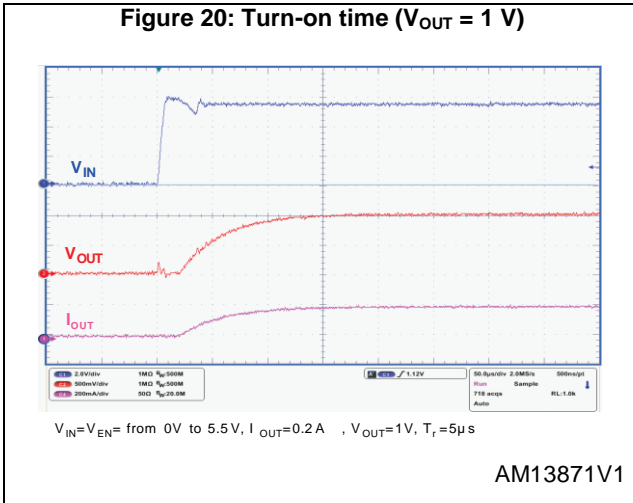
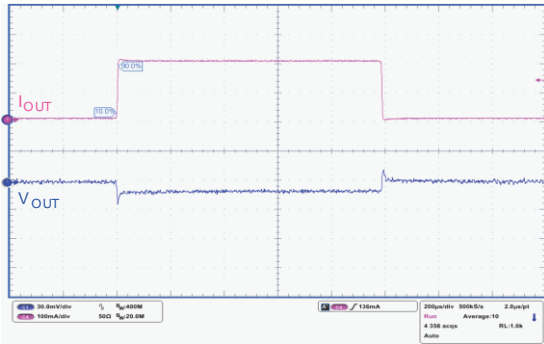

Figure 26: Load transient ($V_{OUT} = 1\text{ V}$)



$V_{IN}=V_{EN}=2\text{V}$, I_{OUT} =from 0 to 0.2A, $V_{OUT}=1\text{V}$, $t_r=t_f=5\mu\text{s}$

AM13877V1

Figure 27: Load transient ($V_{OUT} = 5\text{ V}$)

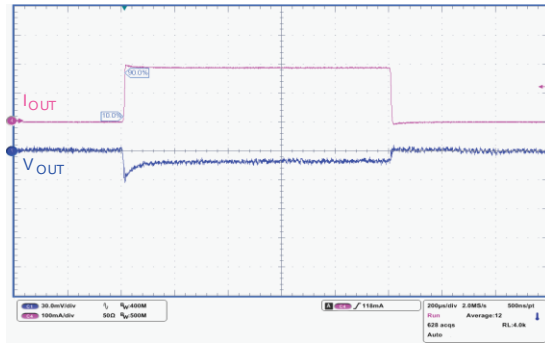

$V_{IN}=V_{EN}=5.5\text{V}$, I_{OUT} =from 0 to 0.2A, $V_{OUT}=5\text{V}$, $t_r=t_f=5\mu\text{s}$

AM13878V1

8 Package information

In order to meet environmental requirements, ST offers these devices in different grades of ECOPACK® packages, depending on their level of environmental compliance. ECOPACK® specifications, grade definitions and product status are available at: www.st.com. ECOPACK® is an ST trademark.

8.1 DFN4 1x1-4L package information

Figure 28: DFN 1x1-4L package outline

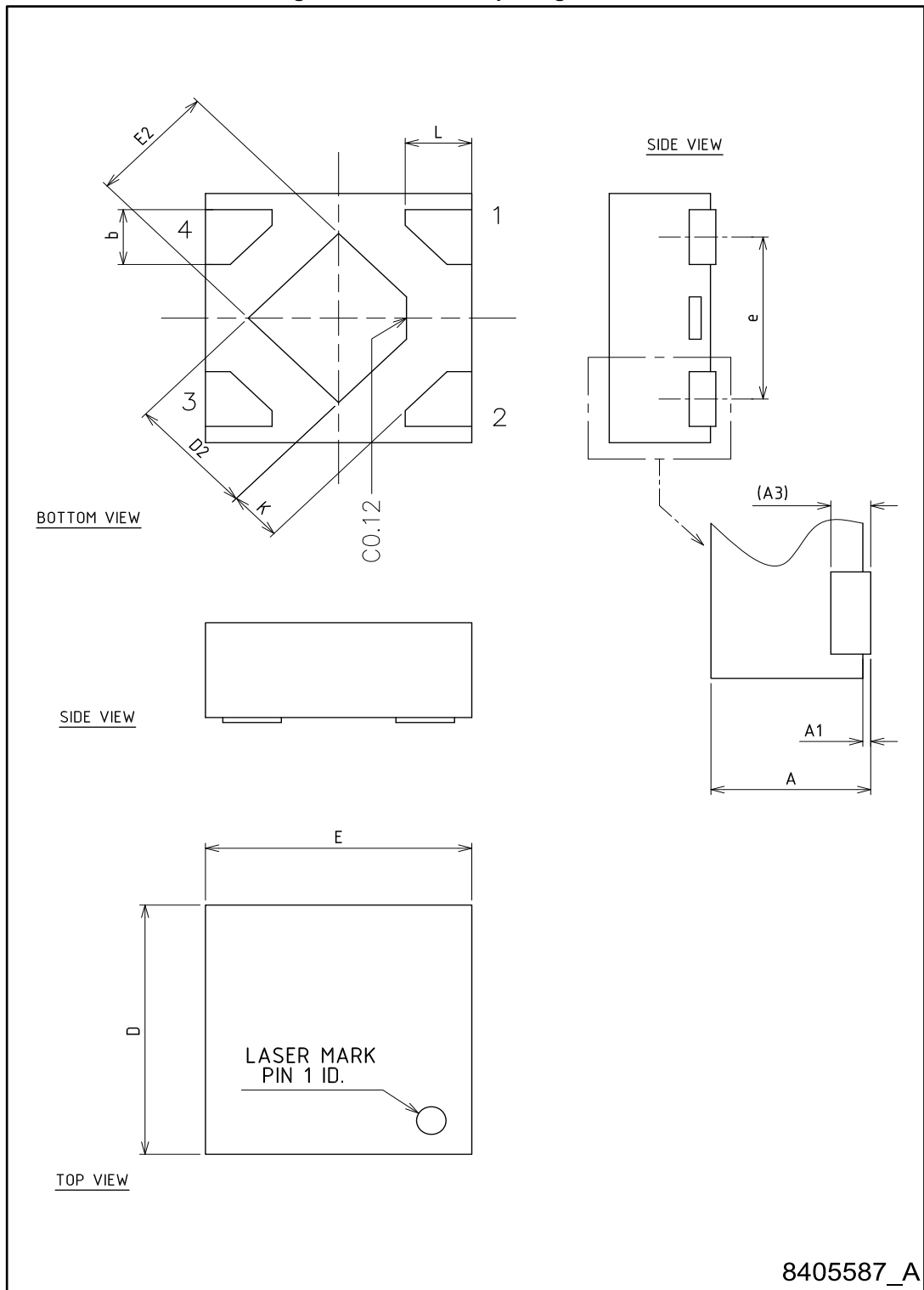
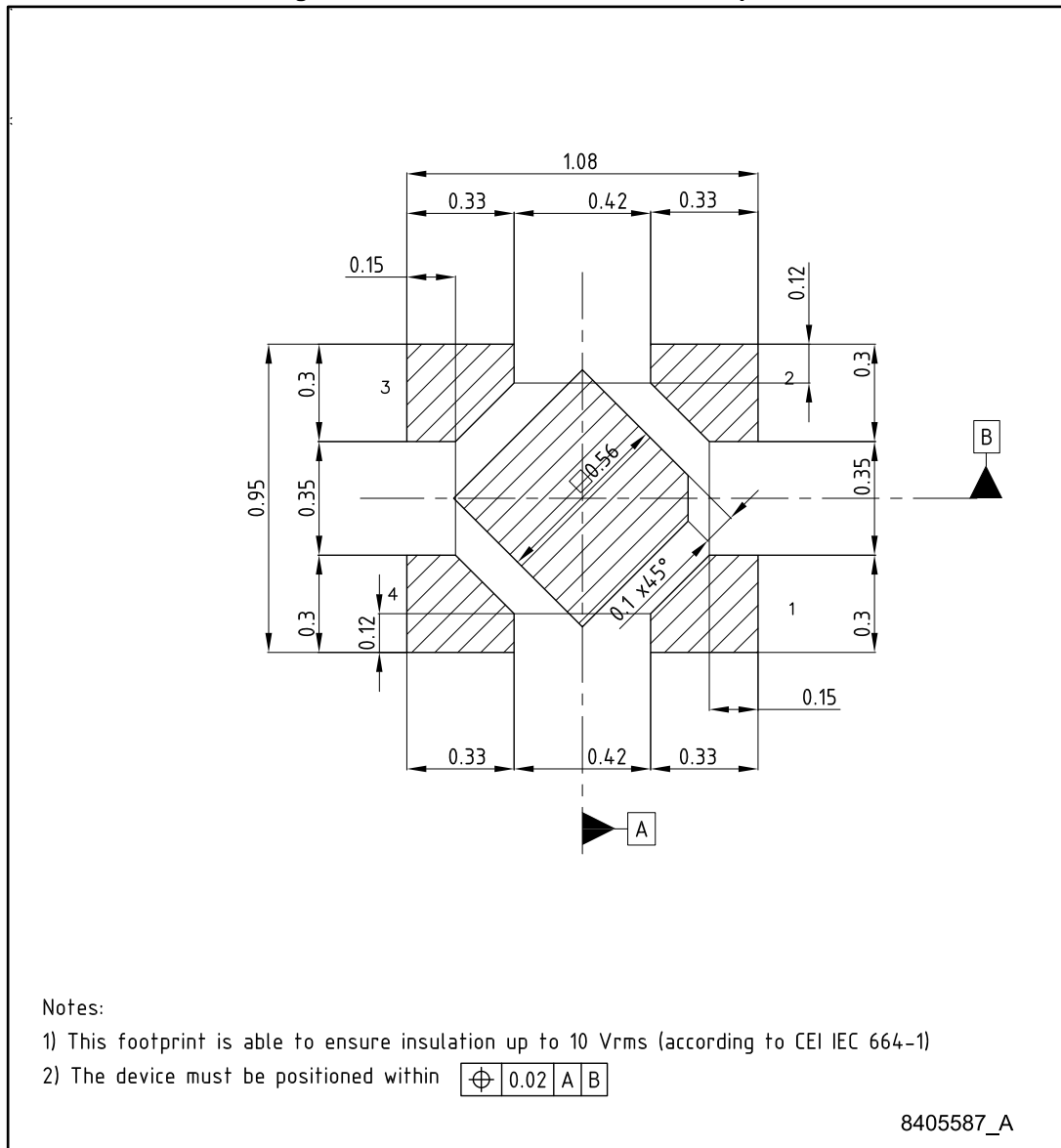

Table 7: DFN 1x1-4L mechanical data

Dim.	mm.		
	Min.	Typ.	Max.
A	0.34	0.37	0.40
A1	0	0.02	0.05
A3		0.10	
b	0.17	0.22	0.27
D	0.95	1.00	1.05
D2	0.43	0.48	0.53
E	0.95	1.00	1.05
E2	0.43	0.48	0.53
e		0.65	
L	0.20	0.25	0.30
K	0.15		

Figure 29: DFN 1x1-4L recommended footprint



8.2 SOT23-5L package information

Figure 30: SOT23-5L package outline

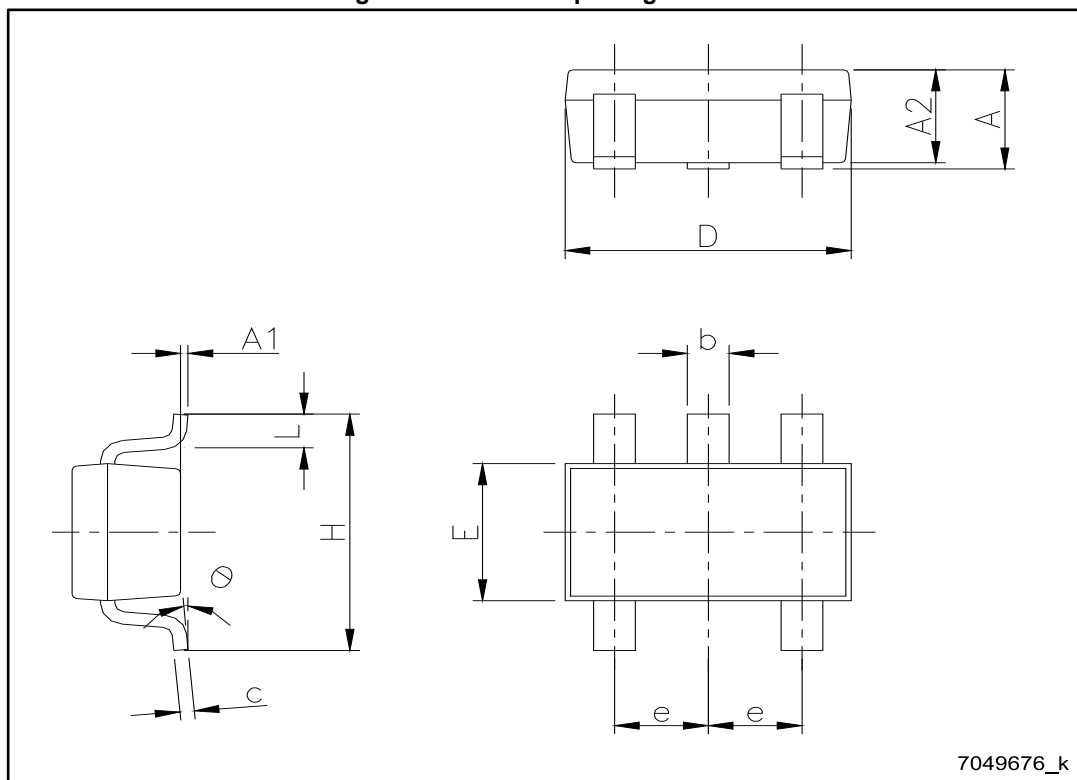
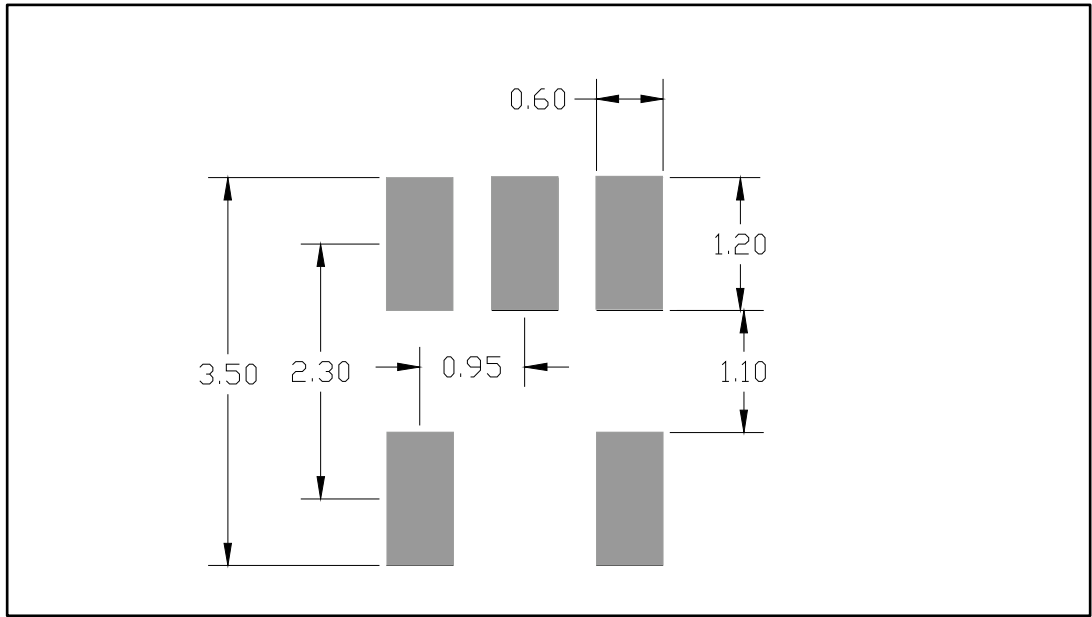

Table 8: SOT23-5L mechanical data

Dim.	mm		
	Min.	Typ.	Max.
A	0.90		1.45
A1	0		0.15
A2	0.90		1.30
b	0.30		0.50
c	0.09		0.20
D		2.95	
E		1.60	
e		0.95	
H		2.80	
L	0.30		0.60
θ	0°		8°

Figure 31: SOT23-5L recommended footprint



Dimensions are in mm.

8.3 SOT23-5L packing information

Figure 32: SOT23-5L tape and reel outline

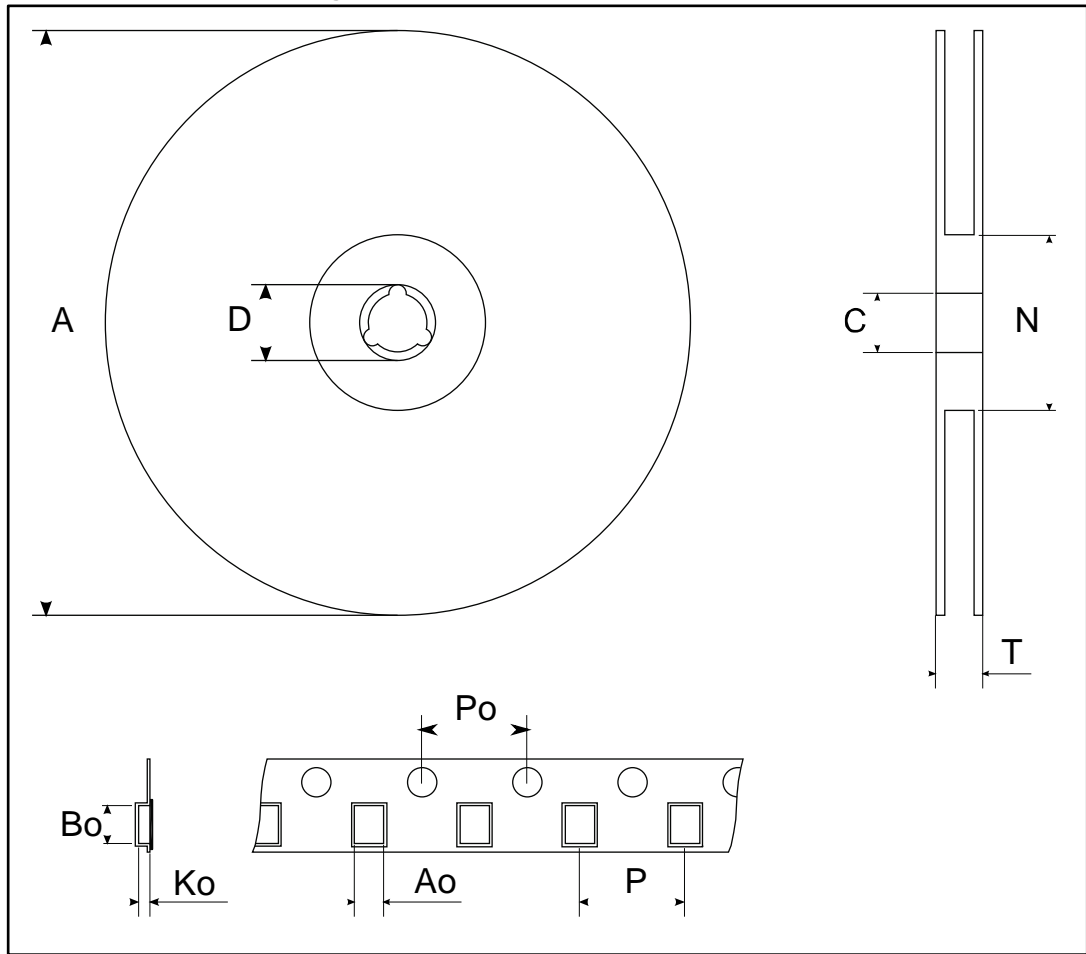

Table 9: SOT23-5L tape and reel mechanical data

Dim.	mm		
	Min.	Typ.	Max.
A			180
C	12.8	13.0	13.2
D	20.2		
N	60		
T			14.4
Ao	3.13	3.23	3.33
Bo	3.07	3.17	3.27
Ko	1.27	1.37	1.47
Po	3.9	4.0	4.1
P	3.9	4.0	4.1

9 Order code

Table 10: DFN1x1-4L order code

Order code	Output voltage (V)	Auto-discharge	Tolerance (%)	Marking
LD39020ADTPU08R ⁽¹⁾	0.8	Yes	0.5	A1
LD39020DTPU08R			2	08
LD39020ATPU08R ⁽¹⁾		No	0.5	B1
LD39020TPU08R ⁽¹⁾			2	C1
LD39020ADTPU095R ⁽¹⁾	0.95	Yes	0.5	A2
LD39020DTPU095R			2	95
LD39020ATPU095R ⁽¹⁾		No	0.5	B2
LD39020TPU095R ⁽¹⁾			2	C2
LD39020ADTPU10R ⁽¹⁾	1	Yes	0.5	A3
LD39020DTPU10R			2	10
LD39020ATPU10R ⁽¹⁾		No	0.5	B3
LD39020TPU10R ⁽¹⁾			2	C3
LD39020ADTPU11R ⁽¹⁾	1.1	Yes	0.5	A4
LD39020DTPU11R			2	11
LD39020ATPU11R ⁽¹⁾		No	0.5	B4
LD39020TPU11R ⁽¹⁾			2	C4
LD39020ADTPU12R ⁽¹⁾	1.2	Yes	0.5	A5
LD39020DTPU12R			2	12
LD39020ATPU12R ⁽¹⁾		No	0.5	B5
LD39020TPU12R ⁽¹⁾			2	C5
LD39020ADTPU13R	1.3	Yes	0.5	AP
LD39020DTPU13R			2	13
LD39020ATPU13R ⁽¹⁾		No	0.5	BP
LD39020TPU13R ⁽¹⁾			2	CP
LD39020ADTPU15R ⁽¹⁾	1.5	Yes	0.5	A6
LD39020DTPU15R			2	15
LD39020ATPU15R ⁽¹⁾		No	0.5	B6
LD39020TPU15R ⁽¹⁾			2	C6
LD39020ADTPU18R ⁽¹⁾	1.8	Yes	0.5	A7
LD39020DTPU18R			2	18
LD39020ATPU18R ⁽¹⁾		No	0.5	B7
LD39020TPU18R ⁽¹⁾			2	C7

Order code	Output voltage (V)	Auto-discharge	Tolerance (%)	Marking
LD39020ADTPU185R ⁽¹⁾	1.85	Yes	0.5	AR
LD39020DTPU185R ⁽¹⁾			2	85
LD39020ATPU185R ⁽¹⁾		No	0.5	BR
LD39020TPU185R ⁽¹⁾			2	CR
LD39020ADTPU20R ⁽¹⁾	2	Yes	0.5	A8
LD39020DTPU20R			2	20
LD39020ATPU20R ⁽¹⁾		No	0.5	B8
LD39020TPU20R ⁽¹⁾			2	C8
LD39020ADTPU21R ⁽¹⁾	2.1	Yes	0.5	A9
LD39020DTPU21R			2	21
LD39020ATPU21R ⁽¹⁾		No	0.5	B9
LD39020TPU21R ⁽¹⁾			2	C9
LD39020ADTPU25R ⁽¹⁾	2.5	Yes	0.5	AA
LD39020DTPU25R			2	25
LD39020ATPU25R ⁽¹⁾		No	0.5	BA
LD39020TPU25R ⁽¹⁾			2	CA
LD39020ADTPU27R ⁽¹⁾	2.7	Yes	0.5	AB
LD39020DTPU27R			2	27
LD39020ATPU27R ⁽¹⁾		No	0.5	BB
LD39020TPU27R ⁽¹⁾			2	CB
LD39020ADTPU28R ⁽¹⁾	2.8	Yes	0.5	AC
LD39020DTPU28R			2	28
LD39020ATPU28R ⁽¹⁾		No	0.5	BC
LD39020TPU28R ⁽¹⁾			2	CC
LD39020ADTPU285R ⁽¹⁾	2.85	Yes	0.5	AD
LD39020DTPU285R			2	85
LD39020ATPU285R ⁽¹⁾		No	0.5	BD
LD39020TPU285R ⁽¹⁾			2	CD
LD39020ADTPU29R ⁽¹⁾	2.9	Yes	0.5	AE
LD39020DTPU29R			2	29
LD39020ATPU29R ⁽¹⁾		No	0.5	BE
LD39020TPU29R ⁽¹⁾			2	CE
LD39020ADTPU30R ⁽¹⁾	3	Yes	0.5	AF
LD39020DTPU30R			2	30
LD39020ATPU30R ⁽¹⁾		No	0.5	BF
LD39020TPU30R ⁽¹⁾			2	CF

Order code	Output voltage (V)	Auto-discharge	Tolerance (%)	Marking
LD39020ADTPU31R ⁽¹⁾	3.1	Yes	0.5	AG
LD39020DTPU31R			2	31
LD39020ATPU31R ⁽¹⁾		No	0.5	BG
LD39020TPU31R ⁽¹⁾			2	CG
LD39020ADTPU32R ⁽¹⁾	3.2	Yes	0.5	AH
LD39020DTPU32R ⁽¹⁾			2	32
LD39020ATPU32R ⁽¹⁾		No	0.5	BH
LD39020TPU32R ⁽¹⁾			2	CH
LD39020ADTPU33R ⁽¹⁾	3.3	Yes	0.5	AJ
LD39020DTPU33R			2	33
LD39020ATPU33R ⁽¹⁾		No	0.5	BJ
LD39020TPU33R ⁽¹⁾			2	CJ
LD39020ADTPU36R ⁽¹⁾	3.6	Yes	0.5	AK
LD39020DTPU36R			2	36
LD39020ATPU36R ⁽¹⁾		No	0.5	BK
LD39020TPU36R ⁽¹⁾			2	CK
LD39020ADTPU40R ⁽¹⁾	4	Yes	0.5	AL
LD39020DTPU40R			2	40
LD39020ATPU40R ⁽¹⁾		No	0.5	BL
LD39020TPU40R ⁽¹⁾			2	CL
LD39020ADTPU47R ⁽¹⁾	4.7	Yes	0.5	AM
LD39020DTPU47R			2	47
LD39020ATPU47R ⁽¹⁾		No	0.5	BM
LD39020TPU47R ⁽¹⁾			2	CM
LD39020ADTPU50R ⁽¹⁾	5	Yes	0.5	AN
LD39020DTPU50R			2	50
LD39020ATPU50R ⁽¹⁾		No	0.5	BN
LD39020TPU50R ⁽¹⁾			2	CN

Notes:⁽¹⁾Available on request.

Table 11: SOT23-5L order code

Order code	Output voltage (V)	Auto-discharge	Tolerance (%)	Marking
LD39020ADM30R ⁽¹⁾	3.0	Yes	0.5	AD30

Notes:

⁽¹⁾ Available on request.

10 Revision history

Table 12: Document revision history

Date	Revision	Changes
04-Dec-2013	1	Initial release.
02-Apr-2014	2	Updated Table 10: "DFN1x1-4L order codes" .
15-Jun-2015	3	Added SOT23-5L package. Modified features and description in cover page. Updated Section 7: "Pin configuration" and Table 3: "Thermal data" . Added Section 13.2: "SOT23-5L package information" and Section 13.3: "SOT23-5L packing information" . Minor text changes.

IMPORTANT NOTICE – PLEASE READ CAREFULLY

STMicroelectronics NV and its subsidiaries ("ST") reserve the right to make changes, corrections, enhancements, modifications, and improvements to ST products and/or to this document at any time without notice. Purchasers should obtain the latest relevant information on ST products before placing orders. ST products are sold pursuant to ST's terms and conditions of sale in place at the time of order acknowledgement.

Purchasers are solely responsible for the choice, selection, and use of ST products and ST assumes no liability for application assistance or the design of Purchasers' products.

No license, express or implied, to any intellectual property right is granted by ST herein.

Resale of ST products with provisions different from the information set forth herein shall void any warranty granted by ST for such product.

ST and the ST logo are trademarks of ST. All other product or service names are the property of their respective owners.

Information in this document supersedes and replaces information previously supplied in any prior versions of this document.

© 2015 STMicroelectronics – All rights reserved

Mouser Electronics

Authorized Distributor

Click to View Pricing, Inventory, Delivery & Lifecycle Information:

STMicroelectronics:

[LD39020DTPU33R](#) [LD39020DTPU31R](#) [LD39020DTPU18R](#) [LD39020ADTPU25R](#) [LD39020TPU32R](#)
[LD39020ADTPU33R](#) [LD39020TPU33R](#) [LD39020DTPU13R](#) [LD39020ADTPU18R](#) [LD39020ADTPU21R](#)
[LD39020ADTPU08R](#) [LD39020ADTPU30R](#) [LD39020ATPU33R](#) [LD39020DTPU30R](#) [LD39020ADTPU28R](#)
[LD39020TPU185R](#) [LD39020DTPU47R](#) [LD39020ATPU185R](#) [LD39020ADM30R](#) [LD39020DTPU11R](#)